

HAVING FUN WITH TRAINS

DECEMBER 2023 | FREE

MRH

MODEL RAILROAD HOBBYIST

ALSO:

- Solving brass steamer shorts
- Casting your own log cars
- Real glass for windows
- Model a waterfall scene
- ... *and more inside!*



Thom Driggers steps through ...

Finishing an undec'd bulkhead flat

BEFORE

▶ READ NOW



ADAPTIVE EDITION
Landscape or Portrait depending on screen size



DOWNLOAD

TABLE OF CONTENTS

This is the screen-adaptive PDF version of MRH magazine

This PDF will try to fill the screen. If the screen is wide enough, it displays two facing pages (emulating the old landscape format), otherwise it displays one page in portrait.

On mobile devices, if you change your device orientation, the PDF adapts to fill the screen with either a portrait or a landscape view as appropriate.

WORKS BEST WITH ...

- Windows: open with Acrobat or Firefox
- Mac: open with Preview, Acrobat, or Firefox
- Linux: open with Acrobat or Firefox
- Apple iPad or iPhone: open with SideBooks app (free)
- Android tablet or phone - open with SideBooks app (free)

If you're not seeing the PDF adapt, then your PDF viewer lacks the adaptive display feature. Please use one of the recommended free PDF viewing apps listed above to get the screen adaptive behavior. Or try the Wide Edition instead.

ALL ABOARD FOR FUN!

WITH ATLAS' ORIGINAL AND GLOW IN THE DARK TRAINKIDS SETS & ACCESSORIES



Amtrak, Acela® and their respective logos are registered service marks, and Quiet Cars is a service mark of the National Railroad Passenger Corporation.



#15 000 000 Trainkids Passenger Train Set features:

- Amtrak® Acela® Powered Locomotive and First Class Battery Car
- Cafe Car, Business Class-Quiet CarSM and Unpowered Locomotive
- 38" x 56" oval incl. 12 Pieces of Curved; 4 Pieces of Straight Track
- Remote Control operated headlight, horn, bell & "Welcome Aboard" announcement



#15 000 100 Glow in the Dark Trainkids Passenger Train Set features:

- Powered Locomotive and First Class Battery Car
- 2 Passenger Cars and Unpowered Locomotive
- 38" x 56" oval incl. 12 Pieces of Curved; 4 Pieces of Straight Track
- Remote Control operated headlight, horn, bell & "Welcome Aboard" announcement

**CHECK OUT THE FULL LINE OF
ATLAS TRAINKIDS TRAIN SETS,
ACCESSORIES AND LAYOUT PACKAGES**

CLICK HERE!

FOR MORE INFORMATION OR TO LOCATE A DEALER, PLEASE VISIT WWW.ATLASRR.COM.
ATLAS MODEL RAILROAD CO, INC. • 378 Florence Ave., Hillside, NJ 07205



REGISTER
(free)

[INDEX](#)

[TABLE OF CONTENTS](#)

STAFF

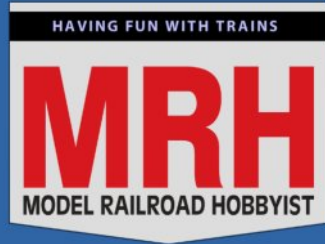

Model Railroad Hobbyist |

December 2023 | #166

Editorial Staff



Joe D. Fugate, Publisher and Editor



James Regier, Assistant Editor



Patty Fugate, Pasteup and Layout



Richard Bale, News and events



Jeff Shultz, News and events, Tech Assistant



Mike Dodd, Copy Editing

Get more issues like this



ISSN 2152-7423

V1.0 December 15

Advertising

Les Halmos, Account Manager

Jean-François Delisle, Marketing Assistant

Regular contributors

Eric Hansmann, Contributing editor

Jim Six, Limited Modeler column (RE)

Ken Patterson, Reporter-at-Large

Rotating Columnists (RE)

Greg Baker, Getting Real column

Al Daumann, Getting Real column

Jeff Johnston, Getting Real column

Mike Rose, Getting Real column

Jim Providenza, Getting Real column

Tony Thompson, Getting Real column

Published for the glory of God. [What's this?](#)

MRH SPONSORS



Model Railroad Hobbyist | December 2023

A - L



acculites.com



railroadhobbyshow.com



www.atlasrr.com



bachmanntrains.com

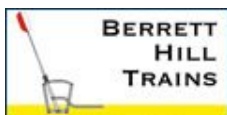

berretthill.com/trains



blairline.com



coffmaneng.com



deluxematerials.co.uk



www.digitrax.com



esu.eu/en



handlaidtrack.com



iascaled.com



litchfieldstation.com



wifmodelrailroad.com

[Vendors: Get your clickable logo on these pages ...](#)



REGISTER
(free)

[INDEX](#)

[TABLE OF CONTENTS](#)

MRH SPONSORS | 2

M - Z



micro-trains.com



store.mrhmag.com



www.modelrectifier.com



handlaidtrack.com/mt-albert-scale-lumber



ncedcc.com



www.pwrs.ca/main.php



rapidotrains.com



ringengineering.com



rockislandhobby.com



scaletrains.com



scottantiquemarket.com



www.siskiyouline.com



soundtraxx.com



sodigi.com



sbs4dcc.com



tamvalleydepot.com



train-fest.com



walters.com

Looking for something? Check the MRH Marketplace!



Take me there!

MRC's Light Genie

20 Different Lighting Effects



Control On/Off



Control Brightness/Dimming



Automatic Sequential Lighting



Control Flashing Lights



2.4 GHZ Wireless Remote and Receiver



**CLICK HERE
FOR DETAILS**

**Multi-faceted for the pro.
Easy-to-Use Palm-size
transmitter for the Newbie.**



M O D E L R E C T I F I E R C O R P O R A T I O N

360 Main Street, Suite 2, Matawan, NJ 07747 • Phone: 732-225-2100 • www.modelrectifier.com

FOUNDED BY ROY C. GELBER

■ Train Controls

■ Model Railroad Accessories

■ Plastic Model Kits

■ Scenery

■ Educational Kits



REGISTER
(free)

[INDEX](#)

[TABLE OF CONTENTS](#)



Publisher's Musings: MRH at 15 years old ...

JOE FUGATE



MULT. SCALES

MRH Website this month: Real glass for windows, ...

Compiled by JOE FUGATE



MULT. SCALES

What's Neat: Visiting Lombard Hobbies ...

KEN PATTERSON



ALL SCALES

Solving brass steamer intermittent shorts

CHARLES HEPPERLE



HO

Upgrading a Walthers undec bulkhead flat

THOM DRIGGERS



On30

Casting your own log buggy cars

BERND FANGHANEL



ALL SCALES

Savvy Modeler online: Modeling a waterfall scene

Compiled by the MRH STAFF



December 2023 news and events

RICHARD BALE and JEFF SHULTZ



NEW ARRIVALS

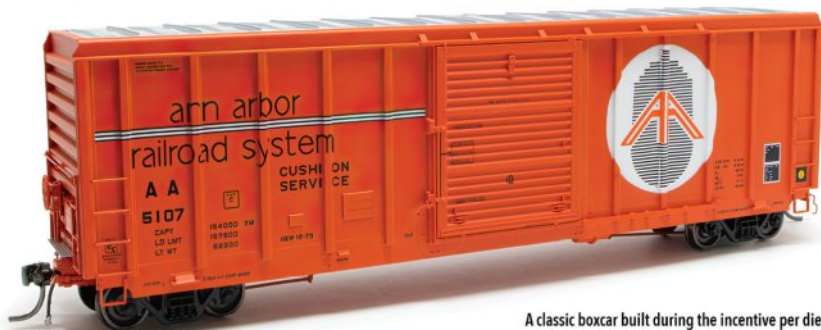

HO
1:87 SCALE

A classic boxcar built during the incentive per diem (IPD) era of railroading of the late 1970s. The Pullman-Standard 5344 was the last successful boxcar project before their end in 1981.

PULLMAN-STANDARD 5344 BOXCAR

HO
1:87 SCALE

PC&F built 17 of the 7883 appliance boxcars for Western Pacific numbering in 1975. Equipped with Airpak bulkheads, they were later removed and the cars were renumbered. Many served into the Union Pacific era and could be seen riding the rails through the 2010s.



PC&F 7633 APPLIANCE BOXCAR



N
1:160 SCALE

Pullman-Standard leased many PS-4427 Covered Hoppers to Cargill starting in 1963. Early deliveries arrived green bodies with the large placard bolted across the middle three ribs of the car. Delivered in July 1964, these cars had black painted ends and underbody. Later deliveries were yellow and both variants operated side-by-side through the 80s.

PULLMAN-STANDARD 4427 COVERED HOPPER



SCALE
TRAINS

scaletrains.com

CLICK THIS AD

ScaleTrains.com • 4901 Old Tasso Rd NE, Cleveland, TN 37312 • 844-9TRAINS 844-987-2467 • International 423-299-3689

© 2023 ScaleTrains, ScaleTrains.com and respective logos are trademarks of ScaleTrains.com, Inc.



REGISTER
(free)

[INDEX](#)

[TABLE OF CONTENTS](#)

PUBLISHER'S MUSINGS



Model Railroad Hobbyist | December 2023



JOE FUGATE: MRH AT 15 YEARS OLD, AND WHAT THE FUTURE HOLDS ...

WE STARTED *MRH* IN JANUARY OF 2009. AS OF THIS ISSUE, IT'S NOW JANUARY 2024, SO *MRH* IS NOW 15 YEARS OLD. Looking back, *a lot* has happened since 2009, but it doesn't seem like now should be here so soon!

Let's look back and review some of the high points, and then let's also look ahead. As the founders and owners, I and my wife Patty are not getting any younger, so do we have an exit strategy regarding *MRH*?

And what about the MRH Media product line? Do we see it continuing beyond us? Will MRH Media still be around in ten years? Twenty years? Or beyond?

2004: Model Trains Video

The story of *Model Railroad Hobbyist* actually started in 2004. I started experimenting with digital video and digital still photography. I got the idea to make and sell model railroading DVDs. Remember at this time, there were no smartphones or tablets.

Digital media required special digital still cameras and special digital video cameras. The good equipment wasn't cheap.

I started shooting digital stills and videos of my Siskiyou Line layout and decided to make some how-to videos about my layout and sell them as on the model-trains-video.com website.

So we did just that for several years.

2008: Model Railroad Hobbyist

My day job at this time was managing software developers, which included web developers. I was always trying to stay ahead of Internet software development and how digital media could be made and distributed over the Internet.

We announced *Model Railroad Hobbyist* magazine in the summer of 2008 at the Anaheim NMRA Convention as a new Model-Trains-Video product.

We stood up the *MRH* website and forum the summer of 2008 in preparation for this announcement. Excitement began building toward the launch of the first free ad-supported digital magazine in January of 2009.

I could see how books and magazines done digitally could include interactive elements. In 2007, Apple introduced the iPhone. Apple positioned the iPhone as the first feature-rich personal media device connected to the World Wide Web.

I could envision a time when virtually everyone would have one of these personal web-connected media devices.

However, the tiny phone screen just wasn't enough, so I felt a jumbo version of the phone must be coming soon. I wrote this in July of 2008:

“I don't think the device we're looking for [ie, for reading a digital magazine] is here yet.

IMO, the perfect device would be close to 8 x 11 in size and display PDFs in color. It would also be inexpensive, maybe selling for \$300 or so.





Holiday Sale

Running Extra + TMTV



... for one special price

MONTHLY

~~\$7.98~~

just

\$2.99 / mth

-OR-

YEARLY

~~\$69.98~~

just

\$35.88 / yr*

Get both RE + TMTV
for \$2.99 / mth ▶

Get both RE + TMTV
for \$35.88 / yr ▶

*Bonus: Includes access to all RE back issues



If the iTouch or iPhone had good native PDF support, it might work. You would navigate by flicking pages left or right, and double tap to zoom to readable size on a page area.”

The first iPad was introduced about 18 months later, in 2010. Ironically, I nailed its size, price point, and feature set. Tablets have since dropped in price such that you can get a 10” Android tablet for just over \$100 dollars now.

Tablets are the ideal device for browsing the web and reading our magazine(s) and eBooks. They’re inexpensive and highly portable. Most PDF readers let you add notes anywhere on the page and to highlight text. Plus you can search for topics and get instant links to what the search finds.

This all included the innovative idea of making the magazine itself free – include advertising and have the advertisers pay for the production costs. The one real trick with this was helping educate a lot of fairly conservative hobby manufacturers in leading edge media tech.

Thanks to our Model Trains Video website and my Siskiyou Line layout website, I had developed a good following. I also had become friends with local modeler Charlie Comstock who also had a nice website about his Bear Creek layout.

Between the two of us (Charlie and me), I estimate we had about 15,000 modelers to which we could promote *MRH*. That seems to have been a pretty good guess, because in short order, we had 16,000 *MRH* readers.

2010-2012: Rapid growth

By 2010, we moved to publishing *MRH* bi-monthly. Circulation grew into the 20 thousands. We also began getting hobby vendors taking us seriously as a place to advertise.

By 2011, we moved to monthly and circulation skyrocketed into the 30 thousands. We had new advertisers coming on



What's new on TMTV

Some recent shining examples ...



Effective scenery modeling, part 2 ...

Effective scenery modeling series



Optimum track cleaning methods



Effective scenery modeling, part 1



Demystifying frog wiring

Watch now ...

Buy individual episodes or get unlimited access as a member



www.trainmasters.tv

Registered MRH reader?

SAVE 10%
click here

Ex-Per Diem Weathered Series

PROTOTYPICALLY INSPIRED WEATHERING AND GRAFFITI
12 CAR SERIES BEGINS APRIL 2024



Sabine River & Northern Railroad,
ex-Corinth & Counce Railroad
\$30.95

Cedar Rapids & Iowa City,
ex-Seattle & North Coast Railroad
\$30.95



**MICRO-
TRAINS®
LINE**

CLICK HERE FOR MORE INFO

N
SCALE 1:150

PUBLISHER'S MUSINGS | 4

board almost every month. Things were really popping – we also got more submissions, building our article backlog nicely.

I started thinking about how *MRH* Media ought to do its own streaming video site, aka, Netflix for model trains. But I was already stretched pretty thin and could not see how I could manage to launch yet another new media product line.

2013: TrainMasters TV

As providence would have it, as I pondered how *MRH* could launch an online streaming model train video service, Barry Silverthorn, a professional PBS video producer and model railroader called me out of the blue.

Long story short, Barry and I partnered to launch TrainMasters TV, *MRH's* new “Netflix for model trains” streaming



REGISTER
(free)

[INDEX](#)

[TABLE OF CONTENTS](#)

video service. Barry would do the heavy lifting, meanwhile *MRH* would market to its audience now approaching 60,000 as of 2013.

Barry's professional PBS video production savvy and his deep understanding of the hobby served us well, with many superb quality video productions becoming a part of the TMTV video library.

2016: The plateau

The buzz with digital media finally started wearing off as of 2016.

The bigger hobby vendors finally understood the Internet well enough to hire a web guy to do their own advertising on Google and YouTube. Who needed a magazine when they could control it completely themselves?

The buzz on the ad-supported web also started to wane with the big guys like Fox and CNN, Time-Warner, Viacom, and a host of big magazines like Newsweek.

The "experts" were advising ad-supported was not

"Right and Splice Clamps"™

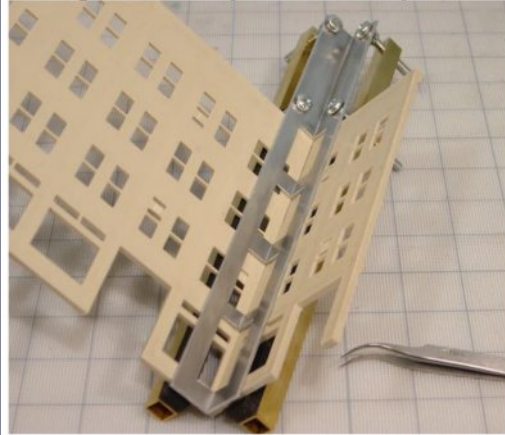

Quality Tools with Superior Versatility

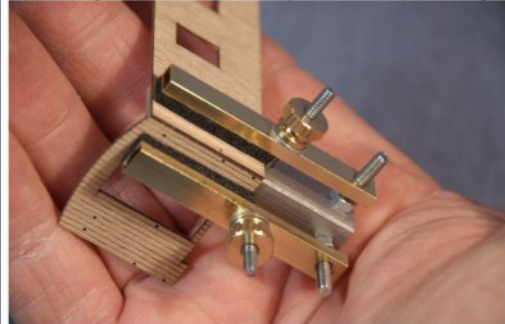

Essential Tools for Great Modeling

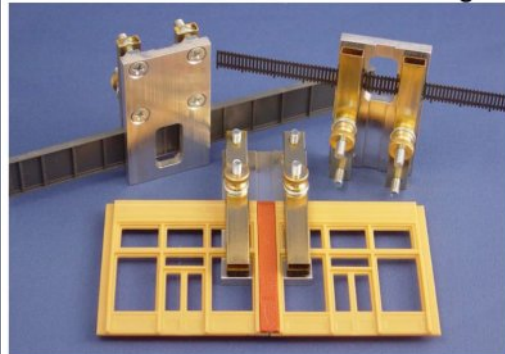

Coffman Graphic Solutions
1500 River Circle, Richmond KY 40475

Click Here

Visit our new Website:
www.coffmaneng.com

enough any longer, content publishers needed to add premium content that was not free as well. Basically, don't put all your eggs in one basket – do the smart thing and diversify your income sources.

We had a huge backlog of great articles, but as ad revenue eroded, the *MRH* page count dropped due to lower ad revenue. So we did another long-story-short business expansion and launched *Running Extra* magazine for all that extra content.

What about the future?

This is my first time going public with what our (the Fugates) exit strategy is with MRH Media. We're both in our late 60s and if we want MRH Media to continue, we need to make sure we have a plan in place.

First, let me say we're taking this slow and being very deliberate about it. As you read what our plans are, know that we're not in a huge hurry and we're evolving the plan as we go.

Basically, the plan is for the Fugates to continue being the primary at MRH Media until 2030. At that time I will be 75 and it will be time to step back and let someone younger take the helm. What I'd like to do is sell MRH Media to someone a lot younger and have them take it over lock, stock, and barrel.

For the record, I'm more interested in seeing *MRH* continue than I am in getting rich, so I intend to be very flexible with terms. I want to make it very affordable for the right person.

Plans are by 2030 that MRH Media will have few liabilities on the balance sheet beyond content owed to subscribers, which is a normal publisher business practice. As to net profit, thanks to a lot of belt tightening during the pandemic, MRH Media is now a lean-and-mean business, being solidly in the black each year.

That means MRH Media not only pays Patty and me a salary, but the business itself, which is a Limited Liability Corporation, makes a profit *on top of that*.



NORTH AMERICAN RAILCAR CORPORATION



**BRITISH
COLUMBIA
RAILWAY**

National Steel Car 5092 cf Combo Door Box Car 1971 - present

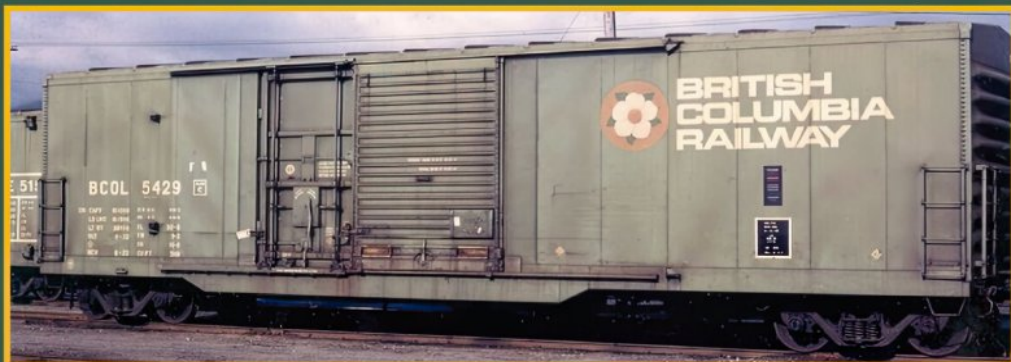

PGE - light green, built 1971



BCOL - light green, built 1972



BCOL - large italic lettering, built 1986



BCOL - 80,000 series, re-built 1990

BCRAIL

The Pacific Great Eastern / British Columbia Railway received 1,785 of these boxcars from National Steel Car between 1971 and 1973, making them the most numerous boxcar on the railway. They were seen all across Canada and the United States in forest product service. From 1989 some were re-built for pulp service and many have continued in service with CN since 2004. North American Railcar Corporation will produce HO & N scale models representing the cars built in 1971 and 1972, and those re-built for pulp and forest product service.



PGE - dark green, light green door, built 1971



BCOL - dark green, built 1972



BCOL - with underline, built 1986



BCOL - brown, CN noodle & url, vents, shopped 2003



BCOL - 100,000 series, re-built 1990 w/vents

HO scale ▶

N scale ▶

12 Rd #s for each, available exclusively at:

Pacific Western Rail Systems

Unit #25, 15531 24th Ave, Surrey, B.C. Canada V4A 2J4
Toll Free: 1-866-840-7777

BIG HAIR • BIG NOISE • BIG POWER

C30-7

The King
OF THE 80s



- State of the art tooling
- Road-specific details
- Working beacons
- GSC or Adirondack trucks
- And much, much more!

NOW FEATURING:



CLICK HERE



Quality. Style. Spirit.™

rapidotrains.com • [youtube.com/RapidoTrains](https://www.youtube.com/RapidoTrains) • [facebook.com/RapidoTrains](https://www.facebook.com/RapidoTrains)

RAPIDO



REGISTER
(free)

[INDEX](#)

[TABLE OF CONTENTS](#)

So we're talking about a hobby business that can support a couple full time people and pay several part time contractors, and will have virtually no debt *and* have a solid net profit at the end of the year.

In a perfect world, we would like to find someone in the next 4-5 years who would be interested in becoming MRH Media's new owner(s) by 2030. Then we would have that person or person(s) become part-time staff for 1-2 years and learn the business ropes.

Once we're ready to bow out, they can take over and already know the business inside-out. A smooth, easy transition.

At least that's the plan and this is our official announcement MRH Media will eventually be for sale. In the meantime, we're committed to continuing to produce new magazines, new videos, and new books for many years to come.

Did you see this article?

in the **NOVEMBER 2023 MRH RUNNING EXTRA!**



More bulletproof layout details

Get full eBook now ▶ ← *click here*

Each eBook has 80-100 pages



Get more articles like this

GIVE IT A LIKE



Tell your friends about MRH!

**We depend on word-of-mouth to grow
... if you don't share us, we don't grow**

Every little bit helps!



Registered MRH readers
get **another** 10% off with
the coupon code here:

Reveal my
coupon code now!

[click here](#)

That's right, on top of our
other sales and discounts, use
this coupon code to get
YET ANOTHER 10% off!



The holiday
season is coming!



TMTV sale offers

[click here](#)



MRH Store sale offers

[click here](#)



REGISTER
(free)

[INDEX](#)

[TABLE OF CONTENTS](#)



LAST ISSUE LIKES

Most liked articles in [November 2023 issue](#) of *MRH* are:

- 1st** Guide to diesel loco trucks
- 2nd** Electrical Impulses: Yes, wire size matters
- 3rd** Kitbashing a stock yard

Most liked articles in [November 2023 issue](#) of *Running Extra* ...

- 1st** Limited Modeler: Modeling the Royal Chair factory
- 2nd** Build an automated lift bridge
- 3rd** Ah-Hah Moment: Improved track cleaning swab

If you want more of this type article, then like the article!
Click the *Give us a like* or *comments* button on each article and press the like button on the article's forum page if you want to see more articles like these. ■

Get the latest Model Railroading News, Tips, Reviews & Opinions



**Our iTunes feed has changed search for
"Crew Call with Mike Rose" to receive the latest episodes!**

www.themodelrailroadpodcast.com

Host:
Mike Rose: www.mrhobby.com

**Don't Miss our Monthly Interviews
& Product Announcements**

In

MRH**RUNNING
EXTRA**

December issue ...

**TABLE OF CONTENTS | RUNNING EXTRA**

December 2023

**RUNNING
EXTRA****Publisher's Welcome: DIY mini-connectors for DCC installs**

JOE FUGATE

**Limited Modeler: National Carbon Coated Paper Co.**

JIM SIX

**Getting Real: Layout compromise and compression**

GREG BAKER

**Upgrading a Sunset brass locomotive**

CHARLES HEPPERLE

**Modeling greasy, oily, locomotive service tracks**

DAVID STECKLER

**Ah-Hah Moment: New & improved HO flex track**

JOE FUGATE

Buy December eBook - \$2.99
97 pages

store.mrhmag.com

Also includes
164-page MRH
in the back!



REGISTER
(free)

[INDEX](#)[TABLE OF CONTENTS](#)

Best of the

MRH FORUM

Forum

MRH
mrhmag.com

THIS
MONTH

Model Railroad Hobbyist | December 2023

Compiled by **JOE FUGATE**



Real glass for windows (microscope cover slides)

You may have heard of microscope cover slides as glass in model windows, since they're real glass. *MRH* forum member **johnholt** asked about it, read the great answer!



[View the full thread on the MRH website](#)

▶ **MRH'S MONTHLY GREAT MODELER POSTS**



1. MRH forum member **LVRALPH** (Ralph D.) started a thread about improving Atlas Trainman hoppers with nice weathering.

Improving an Atlas Trainman covered hopper

MRH forum member **LVRALPH** (Ralph D.) kicked off a thread about improving Atlas Trainman covered hoppers with realistic weathering. He provided several examples, one of which we show here [1].

One forum member **ncgoogs** (Mark G.) commented:

“Ralph, I like what you are doing there, those look nice and crusty on top. I wish mine looked that good. What I like the most is your reweigh data, I really need to start doing that.”

Several other MRH forum members posted their covered hopper weathering examples as well, showing some very nice work.

Read the full thread for more!

[View the full thread on the MRH website](#)



REGISTER
(free)

[INDEX](#)

[TABLE OF CONTENTS](#)

Second Weekend, Every Month!

Scott Antique Markets

+++++featuring+++++

ANTON'S ANTIQUE TOY & TRAIN SHOW

More shows
coming in 2024!

WATCH FOR THE DATES ...

Atlanta Expo Centers

3650 & 3850 Jonesboro RD SE
Atlanta, GA 30354

For Full Schedule & Coupons
Visit our website.

www.scottantiquemarkets.com

Lasercut structures. Highway,
storefront and billboard signs.

Neat ag customer for your railroad:
Farmers Fertilizer Supply



WHAT'S
NEW?



Established 1993...

Blair Line

Available.
Inexpensive.
Realistic.

Autos with working
headlights



and tail lights.

HO and N scale.

Realistic scale accessories-
automobiles, lights, figures,
scenery, military action rail
cars and more.

RIH
Rock Island Hobby

Click for Details:

www.rockislandhobby.com/collections/ho-scale

Siskiyou Line
Professional Grade Railroad Materials

Protect your locomotives & carry them safely.

AVAILABLE IN RED/WHITE/BLUE

1 Box \$39.95
Free shipping in Continental U.S.

SiskiyouLine.com
HO Loads,
Cars and Materials
Proudly Made in The U.S.A.

MRH & NMRA Discount
\$30.00 and free shipping!

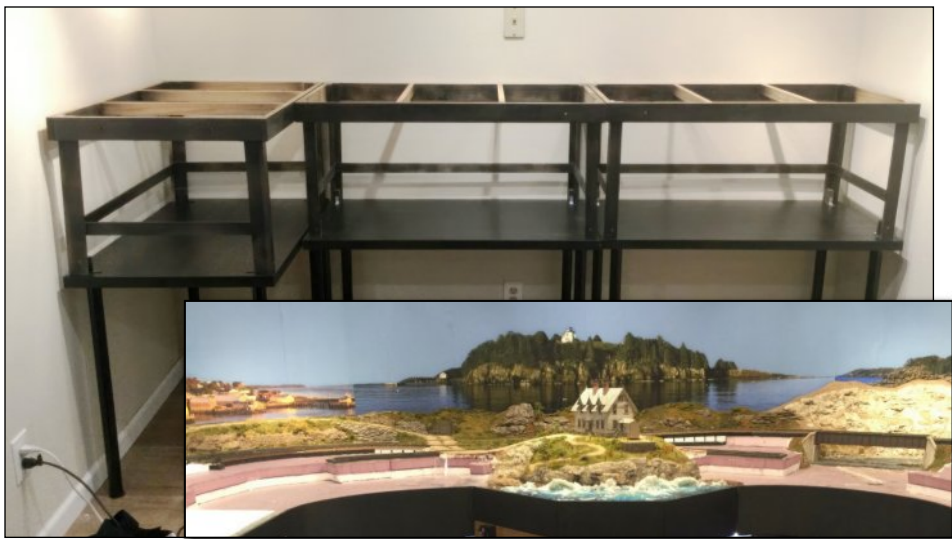

2. *MRH* forum member **J Emerson** had to press the restart button on his layout due to some house repair issues. The inset shows the previous layout.

Emerson Coast 2.0

MRH forum member **J Emerson** had some significant house repair issues come up that involved his layout space, so he had to dismantle the layout to allow house repairs to proceed. With the repairs done, he now gets to do a restart:

“I had some great successes on the last layout ... Alas, I learned a tougher lesson, a scene needs to be based on a solid and well constructed foundation and the trains need to run very well! My prior benchwork ... was a bit sloppy. And the trackwork and wiring, well, ‘nuff said. My desires for this version are similar to the last.”

Follow along as Emerson Coast 2.0 starts to take shape ...

[View the full thread on the *MRH* website](#)



[REGISTER](#)
(free)

[INDEX](#)

[TABLE OF CONTENTS](#)

EAST TRACKS

Build your own trackwork easily, quickly, and affordably.

TRACK BUILDING SYSTEM

Tim Warris developed the Fast Tracks system in 2003 out of his garage while building his Port Kelsey Railway in HO scale. Striving for a better way to handlay accurate track, he developed a fixture to aid in building trackwork faster and easier.

CELEBRATING
20
 SINCE 2003
 YEARS



Those first fixtures have since grown to a library of over 5,000 unique products that are focused on helping modelers build better trackwork and layouts around the world.



• Easy ordering •

shop online 24/7 • handlaidtrack.com

1-888-252-3895

service@fast-tracks.net

3. *MRH* forum member **Craig Townsend** has a complete blow-by-blow blog of his T-D Feeds industry build. Look closely on the right in this photo and you can see the child's face studying Craig's modeling on this 1:29 outdoor railroad industry build. This scene will have some impressive size to it – we can't wait to see the final scene come together. The prototype scene is impressive, and already we're seeing Craig's model of the scene will be impressive.

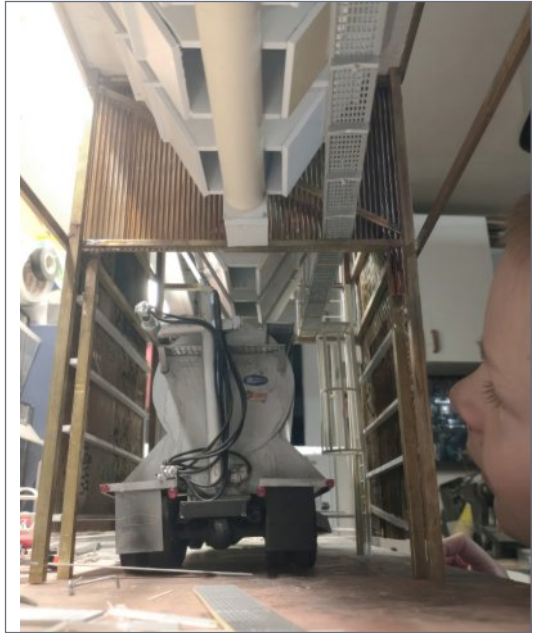

T-D Feeds build log

MRH forum member **Craig Townsend** has started a detailed thread following the build of his T-D Feeds industry scene, based on a real industry in Redmond, WA.

Craig drew a scale 3D model of the scene in SketchUp, and the entire scene will be 6' x 7' and 4' tall in 1/29th scale! Craig says:

“This feed mill is my ‘signature scene’ for sure on the layout and I want to do it justice. Everyone that knows the area I’m modeling knows this feed mill, so I have to get it right. That’s one of the reasons I couldn’t selectively compress it in my mind.”

Follow along with this build on the MRH forum!

[View the full thread on the MRH website](#)

Recent weekly photo fun

Some eclectic tunnel exit photos showed up on recent *MRH* forum weekly photo fun threads, so have a look and visit the forum for details!

View photo fun threads on *MRH* website

4. *MRH* forum member **thewizard1** (Charles D.) posted this tunnel exit photo from his layout with some interesting graffiti. We find the Wile E. Coyote splat to be laugh-out-loud humorous and clever. It's just the kind of thing we would expect a modern graffiti artist to post!



5. Another tunnel exit photo by **thewizard1** (Charles D.) took a bit of study. From the billboard slogan, *Give Wildlife a Chance*, we surmise this is somewhere in Georgia, since that's a popular slogan in that region. Both the billboard and the gals cleaning the car give off a definite *Dukes of Hazzard* hillbilly girls vibe.

Get more articles like this

GIVE IT A LIKE



BACHMANN®

HO SCALE
HO SCALE

THE Queen OF STEAM RETURNS

NORFOLK & WESTERN CLASS J IN HO SCALE

Constructed by the Norfolk and Western Railway in Roanoke, Virginia between 1941 and 1950, the Class J was one of the last great streamlined steam locomotives built in the United States. Despite its late-era arrival, Norfolk & Western was a steam holdout, and the Class J enjoyed a longer service life than many of its contemporaries. Sadly, dieselization eventually spelled the end for all but one of the 14-strong class. Number 611 was preserved, and eventually saw steam again not once, but twice, as part of the Norfolk Southern steam program; first in the 1980s - earning the nickname "Queen of Steam," and again in 2015. Today #611 remains operational as part of the Virginia Museum of Transportation collection and returns to excursion service this fall on the Virginia Scenic Railway. Bachmann's HO Scale Class J also returns this fall, now with Soundtraxx® Econami™ Sound Value On Board®. Available numbered as steam-era #613 and as #611 in both its 1980s-era excursion appearance and as it appears today as the "Spirit of Roanoke," the Queen of Steam is back - and she's never looked so good!



NORFOLK & WESTERN #611 - RAILFAN
Item No. 53201



NORFOLK & WESTERN #613
Item No. 53202



NORFOLK & WESTERN #611 - "Spirit of Roanoke"
Item No. 53203



New "Spirit of Roanoke" version

Click to
learn more

Features include:

- DCC Sound Value® Econami™ sound-equipped
- dual-mode NMRA-compliant decoder for DCC and analog operation
- precision motor
- operating headlight and backup light
- highly-detailed appearance with separately-applied parts
- functioning metal side rods
- magnetically operated E-Z Mate® Mark II couplers
- blackened machined metal wheels with RP25 contours

MSRP: \$489.00 EACH • SHIPPING NOW

Bachmann Industries, Inc. • 1400 East Erie Avenue • Philadelphia, PA 19124 USA • www.bachmanntrains.com

Click for more information.



REGISTER
(free)

[INDEX](#)

[TABLE OF CONTENTS](#)

WHAT'S NEAT

column



Model Railroad Hobbyist | December 2023

KEN PATTERSON COVERS THIS MONTH:

- BROADWAY LIMITED HO GP35 AND N SCALE 4-6-2s
- VISITING LOMBARD HOBBIES
- LAYOUT LIGHTING WITH GEORGE BOGATIUK
- CHRISTMAS TRAIN SETS FROM BACHMANN



click to play video

PHOTOS AND VIDEO OF SUPERB MODELS

IN DECEMBER, Ken shows the new HO scale GP35 and N scale 4-6-2 Pacific locomotives and visits Chicago's Lombard Hobbies. George Bogatiuk describes how he is lighting his layout with LEDs in his new house, and Doug Blaine shows Ken the Bachmann train sets that will be available this Christmas.

New from Broadway Limited



1. In N scale, Broadway Limited has N scale Pacific locomotives in Union Pacific and CB&Q.

in the **JANUARY 2023 MRH RUNNING EXTRA!**

Did you see this article?



Jim Six on how he stays motivated

Get full eBook now ▶

[click here](#)

MRH **RUNNING**
EXTRA

Each eBook has 80-100 pages



REGISTER
(free)

[INDEX](#)

[TABLE OF CONTENTS](#)



In HO scale, Broadway Limited is releasing a model of a GP35, seen here in CB&Q Chinese Red. All the Broadway Limited locomotives are equipped with Paragon4 DCC/Sound as well as being available in Stealth with a DCC socket.

Info: broadway-limited.com

Ken visits Lombard Hobbies



3. Ken interviews Alex, Jeff, and Andrew from Lombard Hobbies.



4. Lombard Hobbies is one of the premier train stores in the United States.

Info: lombardhobby.com

George Bogatiuk demonstrates how he is lighting his layout



5. George and his wife Krissy have purchased a new house, with a larger garage for his layout. Since the layout is sectional it was moved intact to its new location.



REGISTER
(free)

[INDEX](#)

[TABLE OF CONTENTS](#)



6. To begin the process, George built a combination shelf/valance mainly for additional storage space, but also to hold his layout lights.



7. Here is the layout with the lights turned on.



8. On the inside of the valance George mounted these inexpensive light fixtures, using 14 AWG Romex cable to daisy-chain them together. The porcelain cap screws onto the top of the fixture after the wires are connected. A dimmer allows George to vary the amount of light shining on the layout.



9. The underside of the valance is painted sky blue, which both assists in maintaining the illusion of sky from the backdrop and reflects light down onto the layout that is the proper color.



10. George also installed two 50' multi-color strip lights which are controlled through the remote he is holding.



11. The LED strip lights (inset) let George modify the color of the light on the layout, including a blue that will be appropriate for night ops.



12. George holds one of the dimmable LED bulbs he uses in his primary lighting.

New Christmas Train Sets from Bachmann Trains



13. In HO scale, Doug Blaine shows off The Jingle Bell Express train set. Also shown were the North Pole Express, and Thomas Saves Santa's Sleigh.



14. In N scale is the Spirit of Christmas passenger train set seen here, as well as the Merry Christmas Express freight train set.



15. In On30, Bachmann has this battery-powered Norman Rockwell's Main Street Christmas reversing trolley set, as well as a Village Street Car set with an engine house. There are two Christmas streetcars in On30 available separately.



16. Doug shows off the Norman Rockwell's American Christmas passenger train set in On30.

LARGE SCALE

Cowcatcher

Item No. 90043 • Suggested price: \$67.00

Whether they have been left on foot, a smooth ride is important to any rail passenger. The Cowcatcher motor and tender track through corners and tight clearances as they travel from side to side and work through sharp curves on the main straightaway. The track, the car carries complete floor and ceiling detail steam locomotive (with operating headlight, whistle, and speed-controlled chuff sound), tender with coal load, animated coach car with seats, and bobber caboose. Also included is a 3'6" x 4'2" oval of track, 14 power pack with speed controller, and an optional "Back-Mat" instruction manual.

Note: Sound system requires one 9V battery for operation. Battery is not included.

ELECTRIC TRAIN SETS

6'4" x 4'2" Oval of Track

Speed Controller and Plug-in Battery

LARGE SCALE

The Night Before Christmas

Item No. 90027 • Suggested price: \$67.00

There's just one catch: the only way back to town after the Christmas Eve train is found is *The Night Before Christmas* train set. The *Night Before Christmas* train set, with a 4-6-0 steam locomotive (with operating headlight, whistle, and speed-controlled chuff sound), tender with coal load, gondola, bobber caboose, and Santa figure. Also included is a 3'6" x 4'2" oval of track, 14 power pack with speed controller, and an optional "Back-Mat" instruction manual.

Note: Sound system requires one 9V battery for operation. Battery is not included.

ELECTRIC TRAIN SETS

6'4" x 4'2" Oval of Track

Speed Controller and Plug-in Battery

17. In large scale, Bachmann has The Night Before Christmas set, with a North Pole & Southern 4-6-0 locomotive and tender, a gondola, and a bobber caboose. It includes an oval of track and power transformer. A 4-6-0 locomotive is available separately, as is a stock car with animated reindeer heads.



REGISTER
(free)

[INDEX](#)

[TABLE OF CONTENTS](#)



18. In 3-Rail O scale, there is a new Egliner for Christmas.



19. Several other HO scale Christmas products are available separately, such as this 0-6-0 North Pole and Southern locomotive, a powered Cable Car, a Christmas themed Gandy Dancer handcar in HO, and a Christmas themed stock car with animated reindeer heads.



20. In N scale for Christmas is a Brill Streetcar and an 0-6-0 steam locomotive.

Info: bachmanntrains.com

Clicking on the video link at the beginning of this article will show you all of the Broadway Limited products, the Lombard Hobbies interview, George's complete lighting tutorial and demonstration, and all of the products presented from Bachmann Trains. ✓

Get more articles like this

GIVE IT A LIKE



REGISTER
(free)

[INDEX](#)

[TABLE OF CONTENTS](#)

NEW from
the

**Model
Railroad
Hobbyist
Store**

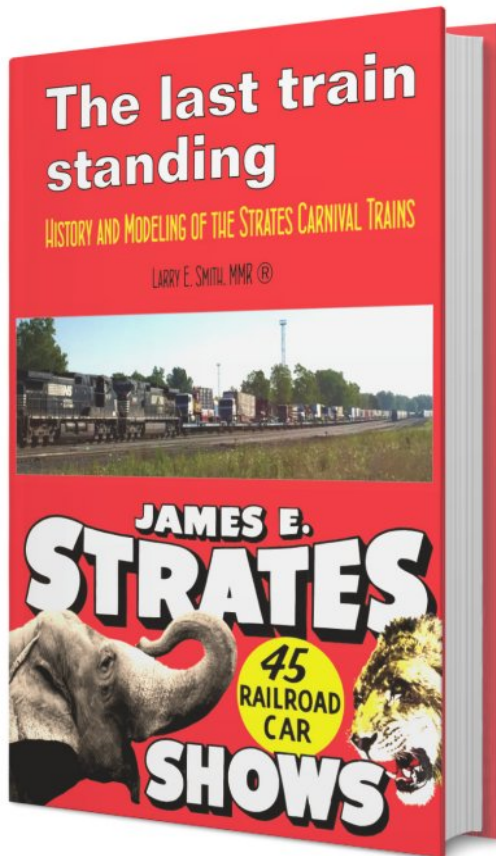

235
pages

800+
historical
photos

eBook • Paperback • Hardbound

LEARN MORE ▶

From first train set to railroad empire...

*Our complete line of DCC products
grows with you. Discover the fun!*

- Designed and manufactured in the U.S.A.
- Preferred for ease of use and ergonomic design
- Unlimited scalability for any size model railroad
- Plug-and-play means more time running trains
- Great customer service and excellent support



See your dealer



REGISTER
(free)

[INDEX](#)

[TABLE OF CONTENTS](#)



Visit our new and improved web site for all your DCC needs!

- Get the latest new product announcements
- Watch our detailed how-to videos
- Browse the all-new Information Station
- Enjoy secure online sales, day or night!

Visit **ncedcc.com**





ESU

The drought is over!



All major
LokSound Decoders
back in stock!

LOK  **SOUND**
EST. 1999

www.loksound.com



REGISTER
(free)

[INDEX](#)

[TABLE OF CONTENTS](#)

SOLVING BRASS STEAMER INTERMITTENT SHORTS



Electrical
Impulses

Model Railroad Hobbyist | December 2023



CHARLES HEPPERLE SOLVES HIS BRASS STEAMER ELECTRICAL PERFORMANCE PROBLEMS ...

UPON COMPLETING MY BRASS STEAM LOCO UPGRADE (SEE THE COVER story in the December 2023 *Running Extra*), my loco just wouldn't run right. The intermittent electrical shorts seemed impossible to find, even as I attempted to over-insulate everything I could find – I'm sure I insulated things that shouldn't have needed it. The loco ran fine on rollers, but it sounded like a coffee grinder on the layout.

I replaced the original SMS gearbox with an NWSL 139-6. I couldn't find a 139-6 to buy individually, but determined it was

one of the two gearboxes in the NWSL 148-6 set intended for articulated locos.

I first pushed out the axle from the uninsulated wheel [1], and pressed out the axle from the old gear. Next, I pushed the new gear onto the axle.

While making this replacement, I discovered the insulated driver on that geared axle was shorting between the wheel and tire! Ah, there's the intermittent short – who would have thought?

I carefully removed the tire and slopped it up with black Floquil paint. After letting it dry for a few minutes to get gummy, I pressed the tire back onto the wheel.

Those two changes made it run like a champ on our 45' x 27' modular layout at the next train show.

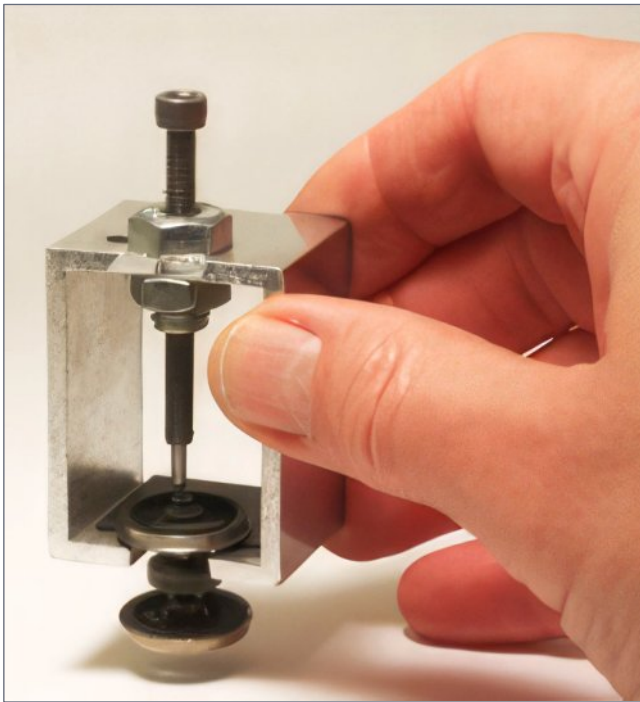

1. I pressed out the axle from the insulated wheel with the NWSL Puller II. Then I pressed out the axle from the original gear.



S T A T I O N

We carry your favorite DCC products!

NCE | Digitrax | Speakers | RailPro

SoundTraxx | Train Control Systems

ESU LokSound | Tam Valley Depot

www.LitchfieldStation.com

sales@litchfieldstation.com

623-298-7355

STREAMLINED BACKSHOP

ALL NEW WEBSITE!

SBS4DCC.COM

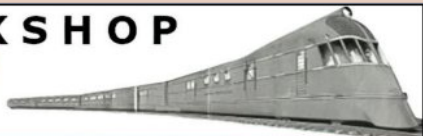

STREAMLINED BACKSHOP

Search Products

Wish Lists | QR Certificate | Recently Viewed | Cart

HOME | SHOP BY DECODER INTERFACE | PRODUCTS & SERVICES | DCC TIPS | MORE INFO | SITE FEEDBACK | BLOG

REQUEST A QUOTE | STREAMLINED BACKSHOP INSTALLATION AND SERVICE | #SBS4DCC

SHOP BY CATEGORY

- New Products
- CD/DVD Books
- SBS4DCC Products
- Auto Reversers & Power Management
- Block Detection & Signaling
- Command Stations, Boosters, Throttles, Accessories
- Mobile Decoders
- Stationary Accessory & Switch Decoders
- Parts & Supplies
- Large Scale (O & G) Products
- The Shelf in The Corner
- Bulk Order
- Shop by Decoder Interface

SHOP BY MANUFACTURER

- DCC Specialties
- Digitrax

Welcome to the NEW Streamlined Backshop... Your Virtual DCC Superstore!

ESU 58941 LokSound 5 Kato USA Widebody

N Scale Drop In Decoder for many Kato models

SHOP NOW

ESU LOKSOUND EST. 1999

WE KNOW LOK

ESU 58941 KATO WIDEBODY

CHECK IT OUT ►

Great control in a tiny package



**Original
Touch Toggles**

- Touch Toggle™ plug in controls
- Bright clear indication
- Easy setup
- Flexible system

Stall Motors, Twin-coils,
Power, and Servos

Now for Tam Valley Depot
and MRservo too!

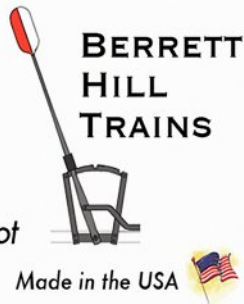

What will they think of next?

www.berrethillshop.com



REGISTER
(free)

[INDEX](#)

[TABLE OF CONTENTS](#)



2. I pressed the axle into the new NWSL gear with the NWSL Sensipress+. When the gear was centered on the axle, I pressed the entire assembly back onto the insulated wheel.

MORE PROBLEMS

Pulling more than six cars (one brass, five plastic) for several hours caused trouble. The gearbox rotated forward, putting side pressure on the main gear shaft that caused the front gearbox bushing to overheat.

My 0.015" torque arm was too flexible and allowed the gearbox to rotate. Fred Hill of The Original Whistle Stop in Pasadena, CA analyzed the problem based on my description. Thanks, Fred! I had presumed that the problem was that the loco pulled too much weight, so I was expecting to have to add power trucks to the tender or baggage-express car. I'm glad I was wrong.

With the motor and gearbox in the correct locations, I cut and bent a piece of brass square tube to strengthen the torque arm [4]. I removed the old torque arm and soldered on the stiffener.

Instead of Shoe Goo, I used five-minute epoxy to cement the arm onto the motor and gearbox. Next, I replaced the sheet styrene “hubcaps” that cover the screw heads on the main driver rods and touched up the paint chips on visible parts of the loco.

The engine ran fine on rollers for about half an hour [5]. The real test would come when it pulled nine or ten cars (probably three brass and the rest plastic) for an hour or two.

REPLACING THE GEARBOX

On a large module layout, the engine pulled about five cars for a few hours without trouble. However, performance then quickly deteriorated with the problem appearing to be poor gear mesh inside the gearbox.

When the gearbox rotated forward, prior to my improvement of the torque arm, the misalignment of the worm shaft heated up the bearings and distorted the plastic gear case holding everything together. I replaced the gearbox with a similar NWSL one [6].

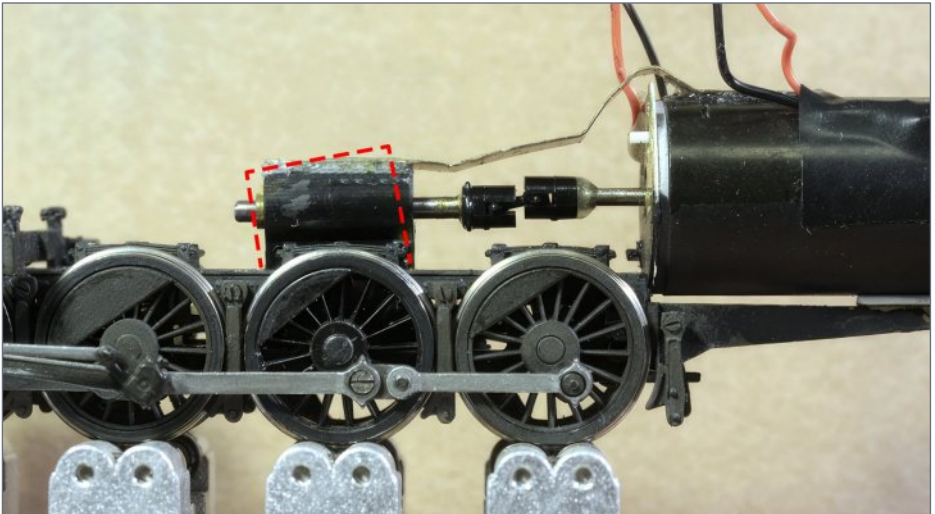

3. The gearbox would eventually rotate forward, causing the gearbox bearing to overheat due to the increased friction. Looks like I need a stiffer torque arm!

A Tale of Two Modelers



Mark



Joe

Two modelers, both making the decision to upgrade their fleet to Blunami Digital Sound Decoders. A seasoned modeler with over 30 years of model railroading under his belt and a complete newcomer to the hobby.

See why they both settled on this unique product by seeing their stories here:

soundtraxx.com/2modelers?utm_source=mrh

Durango, Colorado USA | (970)259-0690 **SOUNDTRAXX** www.soundtraxx.com | sales@soundtraxx.com

ADVERTISEMENT

Still running DC because DCC not worth the time / money / effort?

Discover **LocoFi™**

True multi-loco, multi-engineer control

LocoFi™ Exclusive:

- ✓ Prototypical Ops with SPEED PROFILES
- ✓ Multiple Speed Profiles 
- ✓ Super Fine SPEED CONTROL 
- ✓ Accurate SCALE SPEED 
- ✓ Auto Speed Match for EASY CONSIST
- ✓ Auto Chuff Sync for STEAM **NEW**
- ✓ Emergency Stop (PRESSURE SENSITIVE)
- ✓ Auto Stop NO MORE 'RUNAWAY TRAINS'

... THE LIST GOES ON!!!

Learn more 
wifimodelrailroad.com



Power it your way | **Wireless control** | User customizable
DC, DCC, AC or | using Smartphone | On-board Sound
Battery **LocoFi™** customers never look back ...

When talking
to hobby
vendors,
please
remember to
mention MRH.

Dependable *Wireless* Radio Control!



... and so much more!

GET THE DETAILS ►

click here

RE RINGTM
ENGINEERING



REGISTER
(free)

[INDEX](#)

[TABLE OF CONTENTS](#)

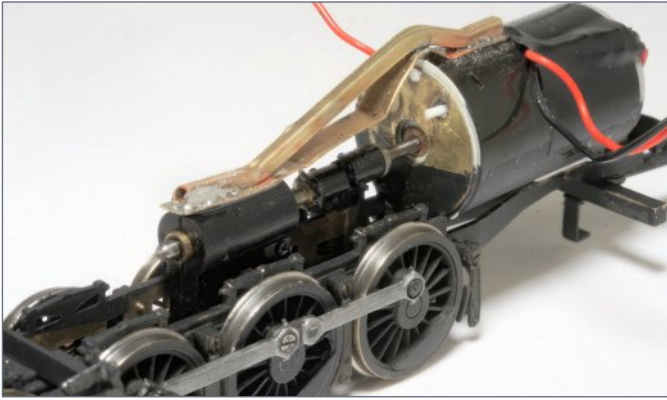

4. I added a beefier torque arm using some brass tubing.



5. Testing the new-and-improved loco on rollers.

It ran great with no load on the Bachrus rollers so I reassembled the rest of the loco to how it performed in operation. The loco only runs a couple of times a year at public shows.

As before, it performed okay for about two hours before the front gearbox bushing finally overheated. That melted the gearbox plastic, the bushing/shaft moved forward, and eventually the U-joint popped out.

I did some “hillbilly engineering,” and made a front shaft keeper [7] to cure the symptom. I also added a 0.015” brass U-shaped wrapper around the gearbox (not shown) to compensate for the melted plastic housing that allowed the shaft to move too far forward.

I was still not sure about the source of the excessive stress/temperature on the front bushing. To forestall future problems, I limited the loco running to about 1-1/2 hours, followed by several hours of rest to cool down. I was still pondering what to do.

TIME TO GET SERIOUS

With my module club's next show coming up for the new summer season, I decided to get serious about solving this loco's problems. My first thought was to add power by building a motorized head-end car. When I inquired about it on an online forum (groups.io/g/RepowerAndRegear) I received a lot of excellent advice about improving the engine and cars first.

An inspection that I should have done earlier revealed that the pilot truck and spring tension were fine. When I pressed down on the loco above the front drivers the springs deflected normally. When I pressed down above the rear drivers there was no spring action all. *Zero, zilch, nada!*

After my original reworking of this loco and its assembly, I had tested the driver springs with it upside-down in a foam cradle and they worked fine. *I'd never thought to test the driver suspension*

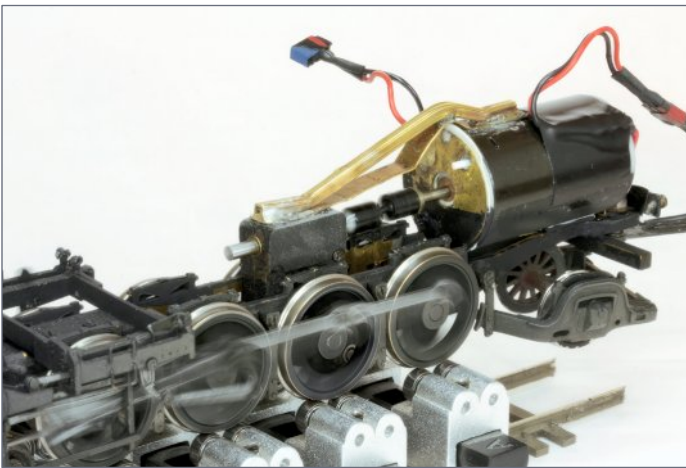

6. Testing the loco on rollers after replacing the gearbox.

TamValleyDepot.com



**Home of the
Frog Juicer**

Dual Frog Juicer

Automatic DCC Polarity
Reverser can be used to:

Power Two Frogs

Crossovers

Crossings

Automatic Reverser for

Turntables

Wyes, Loops

Circuit Breaker

Use with 2-10 Amp Systems

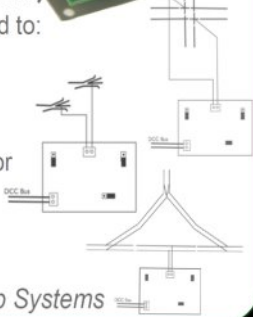

**Jingle Bells never
sounded so
prototypical!**



20% off! (Through Dec. 25th)

**Ho, Ho,
Haul in the
Savings!**



ADVERTISEMENT

Make tortoise wiring more modular!



ACCU-LITES, inc

Your DCC Center!

Dealer Inquiries Accepted



TORTOISE
edge card connector

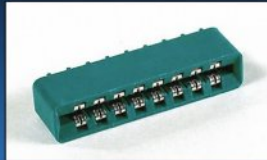

Our Edge Connector redesigned for a SNUG fit!

CLICK TO LEARN MORE ...

MRHMAG.COM

[INDEX](#)

[TABLE OF CONTENTS](#)



Southern Digital

WWW.SODIGI.COM

Celebrating 28 Years serving you



Digitrax just in time for the Holidays



Evolution Express Duplex Radio
List \$655, Your Price \$524



Evolution Express Duplex Radio
List \$470, Your Price \$376



DT602D Radio Throttle
List \$270
Your Price \$216



UT6D Radio Utility Throttle
List \$180
Your Price \$144



DT602 Super Throttle
List \$200
Your Price \$160



UT6 Utility Throttle
List \$115
Your Price \$92



UR93 Duplex Receiver
List \$130
Your Price \$104



BD4N Block Detector
List \$37
Your Price \$29.60



BXPA1 Auto Reverser
List \$49
Your Price \$39



Ni-MH Battery for DT602 or UT6
List \$13
Your Price \$10.40

DCC Conversions, Service & Support

E-mail: sales@sodigi.com (770) 929-1888



REGISTER
(free)

[INDEX](#)

[TABLE OF CONTENTS](#)

with it sitting on the rails. The culprit was the trailing truck contacting the screw head of the truck's limiting bracket.

The crossbar [8] was contacting the screw head and preventing the loco's weight from bearing on the rear driver axles. I ground away material from the crossbar to provide clearance.

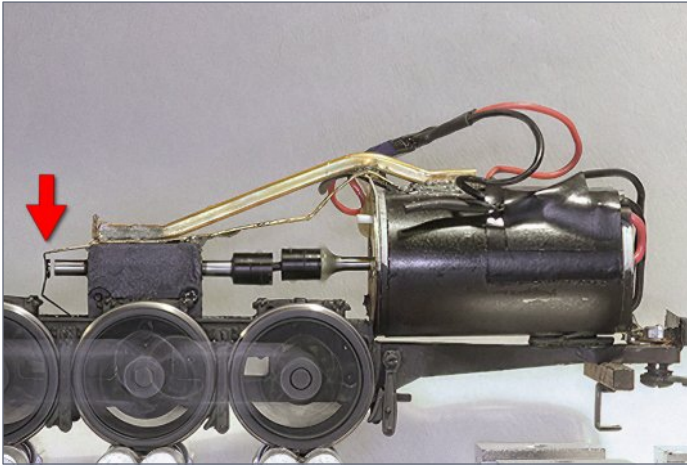

7. I added a stainless-steel keeper with a brass washer at the arrow location to prevent the shaft from moving too far forward.

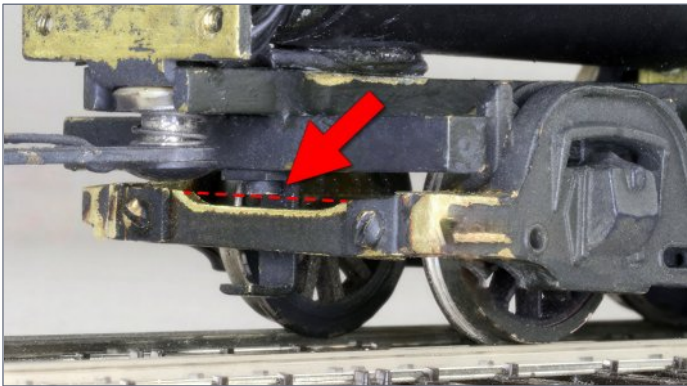

8. The trailing truck on the loco constrained the rear driver suspension and would not allow it to solidly touch the rails. The trailing truck rode high,

thanks to a rear frame screw at the red arrow. I solved the problem by grinding down the rear truck frame (below original contour shown by the red dotted line) to allow for more up-and-down motion over track imperfections.

On the truck side frames, there was a bit of excess material on the castings that I ground off to keep them from contacting the cross beam.

I again replaced the gearbox, this time with the newest version of the venerable NWSL 139-6. I made sure the worm gear bushings would not rotate inside the case causing excess friction with the case.

The new gearbox version from the Montana-based NWSL has a redesigned case that appears to hold the bushings more tightly than before, *and* it has flanges with holes on top to make it easy to attach a removable torque arm. I made a brass channel part with screw holes [9] that fits snugly, but doesn't squeeze the case, then I Shoo-Gooed my old torque arm to it and the motor.

When I modified this loco, I left space for a Tsunami board so I could switch to DCC. Since I had it apart for the gearbox replacement, I made a temporary weight to fit in that space [10].

I'm told that tungsten is 70% denser than lead – that means that it will be heavier than the same volume of lead. I made a plastic tray



9. The new gearbox allowed me to fashion a brass channel with screw and conveniently attach it to the top.

and CA-glued tungsten weights (sold for Pinewood Derby cars) and tungsten shot into it.

Then I mixed up some Durham's Water Putty, a powder that you mix with water for home repairs. Unlike plaster, it is a plastic-like material that doesn't shrink or expand. I added tungsten powder (about 50:50) and used it to fill the voids between the other weights and hold it all together.

Learn more about tungsten weighting here:

model-railroad-hobbyist.com/magazine/running-extra/2018-11/ah-hah-moment

I did some touch-up painting before reassembling the loco.

After that I worked on improving the rolling qualities of the tender and the passenger cars. My best one would roll from a standstill down a 1.1% grade while the worst needed a 4.7%. After improving the engine's pulling power and reducing the drag of the cars, I should be able to add a brass diner, brass lounge, and maybe a plastic head-end car, too.

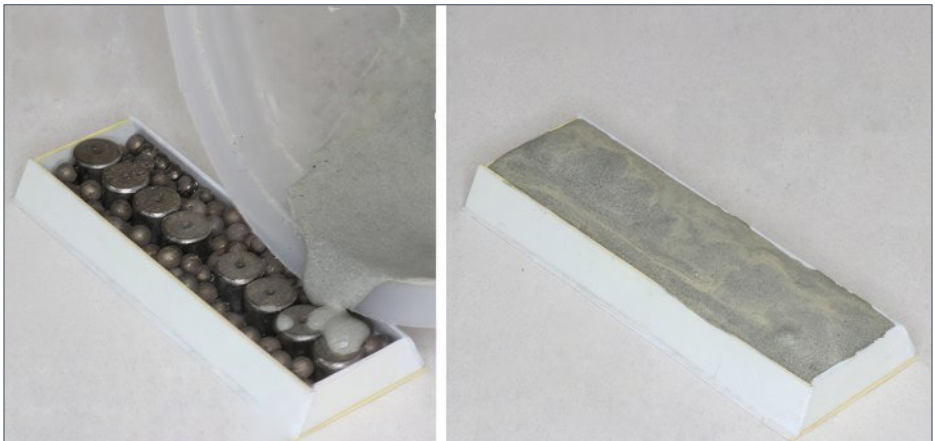

10. I made a custom tungsten weight the same size as the Tsunami decoder and placed it in the boiler where the Tsunami decoder would go.

TORQUE ARM REVISION

The massive torque arm prevented the geared driver axle from moving up-and-down with its spring suspension.

I removed part of the square brass part of the torque arm [11] so only the sheet brass arm would control the movement of the gearbox in relation to the motor. The idea was to still allow up-and-down motion while preventing the gearbox from rotating.

After the addition of the temporary weight, this brought the locomotive's weight up to 19.11 ounces. That is 1.71 ounces above its weight before the latest improvements. By placing a fulcrum under the loco, it showed that the center of balance is about 1/8" behind the center of the drivers' wheelbase. That's almost perfect!

I later upgraded the NWSL 139-6 gearbox with a beefier NWSL 240-6 and a more robust 0.020" brass torque bar strip [12] that cured its mechanical problems completely. The original 0.015" brass strip torque arm was *too flexible*, but the massive brass tube torque arm was just too stiff and definite overkill.

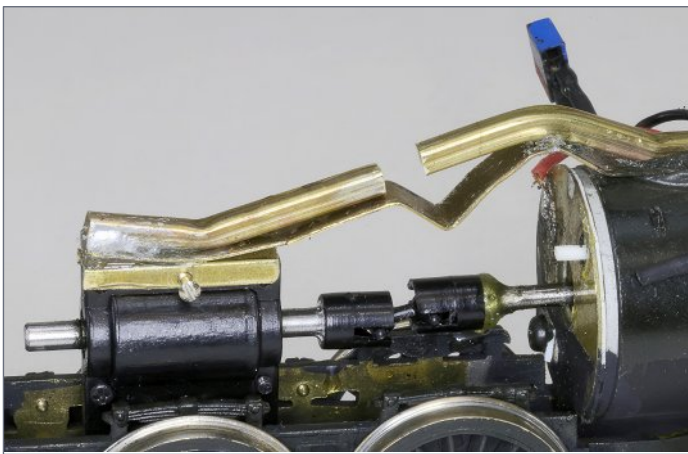

11. The brass tube torque arm was too stiff, so I cut out a section to enable it to flex more.



The heavily weighted loco now pulls a seven-car heavyweight train for two hours on my club's layout at a train show without any trouble. I should have done this upgrade in the first place, the heavier 0.020" brass strip torque arm and new beefier gear box is just perfect!

CONVERTING TO LOCOFi WIRELESS

I converted the brass Sunset 4-8-2 from DC to LocoFi wireless control. Thanks to the plugs and wiring harness I used to make the loco DC-powered, I simply had to make a new wiring harness for the new parts, and I was in business.

The headlight voltage out of the LocoFi decoder is 3.3V, which is perfect for LEDs. But for the 1.5v bulbs, I needed to add a second bulb in series inside the boiler as a ballast to keep the main headlight from burning out.

I expect the incandescent headlight bulb to eventually burn out, so I will replace it with an SMD LED (see the wiring diagram, [14]). Thanks to my modular wiring approach with plugs, swapping to an LED will be straightforward.

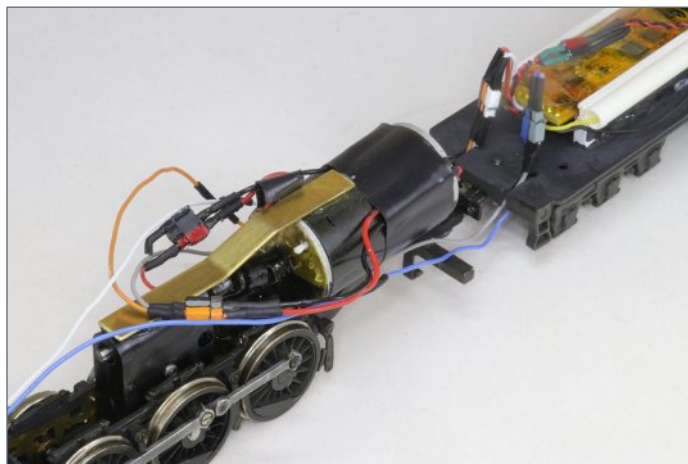

12. When I installed the LocoFi, I replaced the gear box yet again with one newer and beefier, and I made a stiffer 0.020" torque arm this time and attached it with five-minute epoxy

to the motor and gearbox. Problem solved – the loco now runs great for two hours or more.

I used styrene shapes to fashion a slide-in slot for the LocoFi board. I added a styrene tube for the unused yellow rear headlight wire. If I later decide to install a rear headlight, I want to still have the yellow wire available. I also cut slots in the front tender frame for the wires that go to the loco [13].

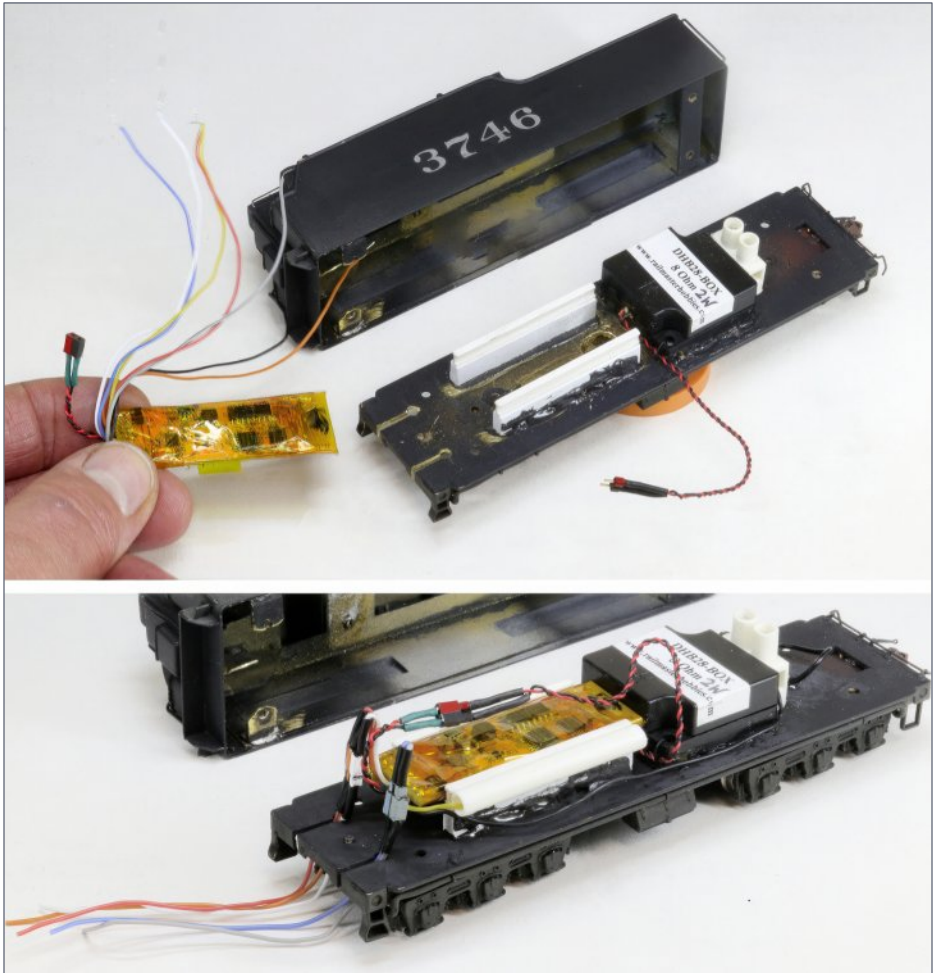

13. Here's the LocoFi decoder installed in the tender. You can see the loco end in [12].

The wireless LocoFi control works great with my \$38 used Android smartphone as the controller – no fancy DCC equipment needed. ✓

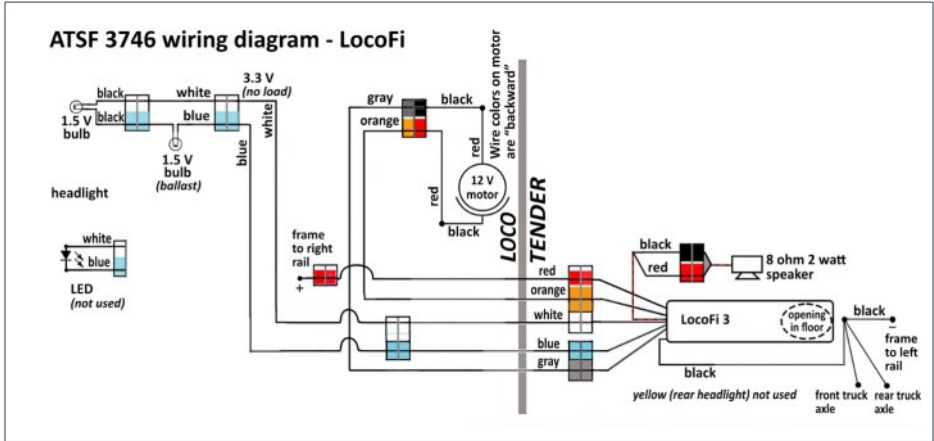

14. LocoFi wiring diagram.

CHARLES HEPERLE



Charles is a native southern Californian. He has been an HO scale model railroader since the early 1970s.

Since 1979 he has concentrated on modeling a fictitious suburb in greater Los Angeles as it might have looked in 1939. Many of the structures are scratch-built models of actual ones.

Charles is a volunteer at the Western Archives of the Santa Fe Railway Historical & Modeling Society in San Bernardino. ■

Get more articles like this

GIVE IT A LIKE



Digit

Introducing the UT6 & for Digitrax Comp



- **Compact size for easy one-hand**
- **Color 1.5" LCD Screen**
- **Full numeric keys for easy Loc**
- **Fine speed control with a large**
- **Removeable LocoNet® cord**
- **Forward/Reverse toggle switc**
- **Off/On switch, uses AA or BP6**

Find out more @ www.



REGISTER
(free)

[INDEX](#)

[TABLE OF CONTENTS](#)



UT6D Utility Throttles Complete Train Control!

Handed operation

UT6

Utility Throttle

\$105.00 MSRP

Automotive selection

UT6D

Duplex Utility Throttle

\$170.00 MSRP

Encoder knob

Hand with Braking

**View all features and *more*
on our website!**

600MH batteries

digitrax.com/throttles/

MRH MARKETPLACE



BackdropsOnly.com
CHRISTMAS Special

**CLICK HERE FOR
BACKDROPS**

**Including Select
Polar Express Scenes**

BackdropsOnly@gmail.com
or Call 800-320-5057

CHECK 'EM OUT



Roomettes

Interiors for your structures

REAL TRACK SCALED DOWN!

Home of the only prototypically accurate
Turnout Kits, Fixtures and Track Parts for HO
and Proto:87.

Scale Spikes, Tie Plates, Real Wood Ties and
Bulk Rail in codes 83, 70, 55 and 40

PROTO87.COM

it's the
little things
that matter
the most



miniprints.com

CROW RIVER PRODUCTS



"O" SCALE KIT 337

STEAM POWERED THREE DRUM WINCH

Provides Three Lines For Clam Shell Buckets Etc.
On Board Two Cylinder Steam Engine.

This Winch will be included in our upcoming Dredge Kit
"O" Scale Kit 338 Due out this Fall

Price 70.00

Made in USA

**HO & O Scale Machinery, Derricks,
Engines, Hardware & Waterfront Models**
Pawtucket, RI 02861 Tel 401-723-0065
www.crowriverproducts.com



REGISTER
(free)

[INDEX](#)

[TABLE OF CONTENTS](#)

LOOK
at what's new at
Black Cat this month

Click here for
our website

CPR 36' Box car
Murphy steel ends 6' door
3D printed by twenty models



Black Cat Publishing
(204)489-5005
ajfergus@mymts.net
blackcatdecals.com

PRE-SIZE
MODEL SPECIALTIES

P.O. Box 6 Paonia, CO 81428

Ph. 970 527 4586

Made in The USA

Cast resin items for All Scales.
Tunnel portals, bridge piers, abutments,
culverts, and retaining walls.
Trackside details and sage brush tree
armatures.

"FREE SHIPPING see website for details"

**Hobby Marketplace
Ads are Economical
and Effective.**

Click to learn more ...

click to learn more!

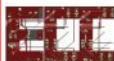

East Coast Circuits
Innovating Your Model Railroad Layout

P.O. Box 25412
Providence, RI 02905

Lighting Circuits For Your Layout

Random Lighting Circuit - Burning Fire Circuit
Traffic Light Circuit - Crossing Signal Circuit

Custom Lighted Vehicles
HO & O Scale Emergency Vehicles
HO & O Scale Trucks & Cars

Eastcoastcircuits.com

Eastcoastcircuits@gmail.com



STRUCTURE KITS AND ACCESSORIES

www.monroemodels.us

Kit HO-7516



Light EFX-16



*Now
available!!!*

- On-layout lighting effects for 16 Just Plug® - compatible outputs; programmable via DCC or LCC
- >30 light effects such as blinking, pulsing, fire, fluorescent tube, traffic signals, photographer, welder, fusee, chase lights and more!
- Programmable brightness
- Trigger via on/off switch, DCC switch command, or LCC fast clock time

LOGIC RAIL™
TECHNOLOGIES

info@logicrailtech.com

(281) 251-5813

www.logicrailtech.com



Emergency / Surveillance Van



www.interactionhobbies.com

PRECISION DESIGN CO.

**CUSTOM DECALS FROM
YOUR OWN ART IN JUST ONE DAY**

PDC.CA

FULL COLOR & SOLID WHITE



Squeaky's Trains

www.SqueakysTrains.com

Free Mystery Gift*
On all orders placed Dec 1-31



* 1 free mystery gift included per order for purchases made on squeakytrains.com, gift is selected by Squeaky's Trains and can not be exchanged or requested.

Let's play with trains!

WE'RE BEHIND YOU ALL THE WAY

Sceniking®

.com

...nothing compares...

Click to learn why!

MONASHEE [CLICK HERE](#)

LASER

ENGINEERING

MANUFACTURING STOCK MODEL KITS

FALL SALE

RAILROAD

STRUCTURES.

Model Railroad Control Systems

- Geoff Bunza Project Boards
- DCC Occupancy Detectors
- CMRInet Compatible Nodes
- Layout Telephone Systems
- RFID Switchlist Generator
- Switch Machines and Drivers



[Click Here](#)

Great Decals!™

FEC, Interstate, Virginian
Railway, & L&N Titles

After Hours Graphics Line
Coupler Gages and More

In O, S, HO, and N Scales



GOLDEN AGE LINE
WESTERFIELD
MODELS, LLC

NEW KIT: 11001 N&W BATTLESHIP GON



ALSO X23/R7 LADDERS

westerfieldmodels.com

Your ad could be in this space for just \$88 a month.

[Click to learn
more ...](#)



REGISTER
(free)

[INDEX](#)

[TABLE OF CONTENTS](#)

THE N-SCALE DIVISION Since 1992

Top Quality **N-SCALE** Discount Prices

American - European - Japanese - DCC/Sound

KATO
PRECISION RAILROAD MODELS

MICRO-TRAINS
LINE

Heischmann

TRIX

SOUNDTRAXX

ESU



ATLAS FREIGHT CAR CLOSEOUTS!

**DOZENS OF MODELS NOW AT 30% OFF MSRP
GET THESE BARGAINS BEFORE THEY'RE GONE**

nscaledivision.com

**Please include
a phone
number when
contacting
MRH**
(in case your spam
filters eat our
email response)

Please tell your buddies about MRH!

WE RELY ON WORD-OF-MOUTH TO
GROW AND A BIGGER CIRCULATION
MEANS MRH IS MORE LIKELY TO STICK
AROUND FOR A LONG TIME TO COME!

Upgrading a Walthers Undecorated 72' Opera Bulkhead Flatcar



THOM DRIGGERS TURNS AN UNSELLABLE CAR
INTO A LAYOUT MASTERPIECE ...



REGISTER
(free)

[INDEX](#)

[TABLE OF CONTENTS](#)





WHILE PICKING UP SOME MODELING SUPPLIES AT THE LOCAL HOBBY shop, I spotted a dusty box sitting on a shelf between some structure kits in the corner. The clerk said it had been there for years, and no one wanted it.

The model was an undecorated Walthers 72' Opera-type center beam flatcar. It was an old school solid one-piece model with minimal detailing, all of which was molded-on. It had no piping or brake rigging, and was equipped with horn-hook couplers [1].

THE BACKSTORY

This car needed a history to give it character and a purpose. It started life on the Milwaukee Road in the mid 1980s. It sat for a while after the railroad's dissolution.

The car was used for a while early in the next merger. It began showing its age, rusting from poor treatment by sloppy forklift operators that damaged some of the ratchet side brackets. The car sat forgotten again, waiting to be repaired.

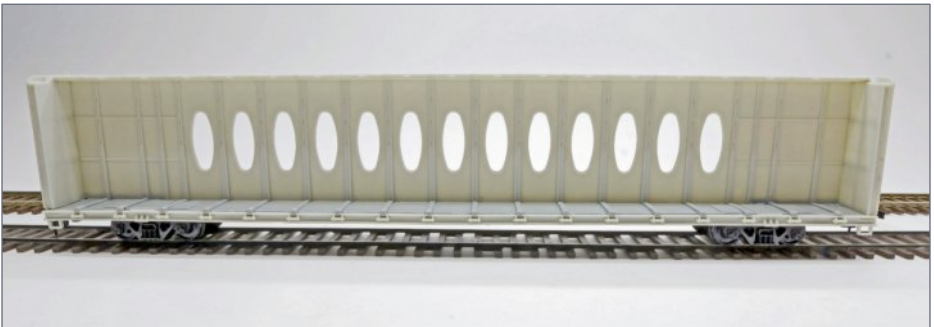

1. This car was a solid one-piece model with minimal detailing.

Eventually, it was sold to its current owner CGTX, where it was used heavily. It is waiting once again to be repaired after deferred maintenance.

The rumor is it might be sold soon to a local lumber company. So, one might see this car in a train being transferred to a repair shop somewhere up north.

On all my builds over the past 43+ years, I like to do things to each project that I know aren't right for rivet counters to discover on their own and discuss. I gave this car two in-your-face details that either don't make realistic sense or are flat-out wrong. See if you can find them.

GETTING STARTED

I began by inspecting the model for any damaged details, mainly the stirrups. I found no damage. I then looked for a good place to start upgrades.

Center beam flatcars feature many teardrop holes for stringing cable to secure loads of lumber. The Walthers model represented these with molded-in dimples [2]. I decided to drill out each of these so that they would more closely represent the prototype, and allow for adding cable detail later.

The teardrop hole drilling process

I loaded a couple of pin vises with no. 79 and no. 76 bits. Once I got into the rhythm, the process of drilling the many cable holes on the car took about five hours to complete. I now know the next one will require many stretch breaks.

I put the model on its side with the top facing away from me, then used the no. 76 bit to drill the top of each teardrop hole. Then, turning the model so the bottom faced toward me, I used the no. 79 bit to drill a small hole at the bottom.

To complete the teardrops, I used a sawing motion with the no. 79 bit. I began at the small hole and gently sawed the bit toward the large hole.

UPGRADING A BULKHEAD FLATCAR | 5

I followed the same procedure for the teardrop holes along the top of the center beam. I also drilled out the eyelet tabs along the top frame [3].

While tedious, the work went quickly. In the end, I broke only 10 bits – the exact number I had on hand! No trip to the hobby shop needed.

COUPLER DRAFT GEARBOXES

I turned my attention to the underside of the frame, and decided to remove the tight radius swing plates [4]. I installed standard no. 5 draft gear boxes with centering springs instead. I assembled the coupler boxes, and tack-glued them to the bottom of the car.



2. The teardrop holes for mounting cables – 12 shown here – are only molded dimples. I decided to drill out each one.

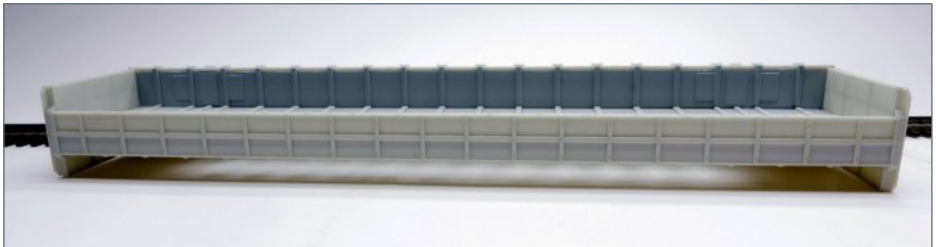

3. I drilled out the top frame tab eyelets along the edge of the top frame (centered between the cross braces) to improve the detailing.



REGISTER
(free)

[INDEX](#)

[TABLE OF CONTENTS](#)

I checked the coupler heights. As luck would have it, they were right on the money!

REMOVAL OF MOLDED-ON RATCHET DETAILS

Staring at oversized, flat molded ratchet spools is not good modeling [5]. However, spending a few hours gently cutting out between the plastic gussets, and drilling holes on both sides to accept 0.012" brass rod is. Static detail is it doesn't have to work, only look good.

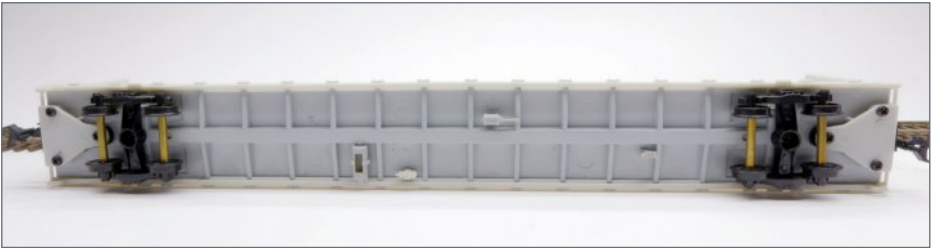

4. I removed the swing plates, and added standard Kadee no.5 draft gearboxes instead. I used the long shank horn-hook couplers for their intended purpose – trash can decoration.

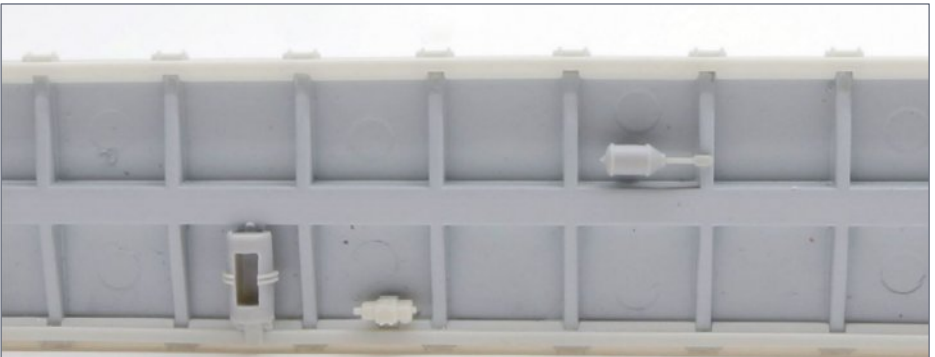

5. The flat, molded-on ratchet cable tubes (top and bottom) were unrealistic. I removed these and added brass rod (which is round, not flat) for this important detail.

To borrow a lyric from a Beatles song, I drilled “four thousand holes in Blackburn, Lancashire,” or in this case, the car. To better understand and appreciate why I took the time to drill so many holes, let’s see the car painted with its first base coat of paint [6].

PREPARATION FOR PAINTING

In addition to drilling the many holes and modifying the molded-on flat ratchet spoons, I cut off the molded-on grab irons for replacement with brass wire [7]. This left the model with lots of tiny plastic bits to clean up. I grit-blasted it with 220 grit aluminum oxide, which cleaned up the plastic bits and helped etch the surface in preparation for painting.

As a long-time brass model builder, I chose Scalecoat I S21 Roof Brown as my base coat for two reasons: First, I know it will stick to the brass details I ADDED all over this model. Second, I know how long this paint takes to cure.

MAKING CUSTOM BRASS DETAIL PARTS

I thought see-through crossover platforms would be good to have for the car ends [7, 8]. I made my own by flattening 0.019” brass rod and forming it into a rectangular frame.



6. The top frame tab eyelets and teardrop eyelets are see-through after painting. This type of detailing sets this model apart from the original, which was simply dimpled.





7. The custom-made 0.012" brass wire grab irons, lift bar, and ratchet tubes are all in place. I also added a brass brake chain and custom-made crossover platform.



8. The custom-made brass see-through crossover platform is in place. Several cable ratchet spools, including these two on the end of the car, have one bracket broken off to represent damage from forklifts. This is why this car has spent so much time waiting for repairs.

I then cut a piece of photo-etched brass walkway to length to fit the frame, and filed the bottom smooth. I soldered it to the frame, then added two pieces of 0.022" brass cross supports to the bottom of the walkway. I cut them long enough to extend across the crossover platform and extend into the car, serving as mounting pins.

I drilled oversize holes into the end of the model's plastic base to accept the 0.022" brass mounting pins, and heat soldered the

UPGRADING A BULKHEAD FLATCAR | 9

crossover platforms on both ends with my solder iron. This made a strong, detailed platform.

I also added Hi-Tech Details rubber air hoses with bungee strap hangers to go with the Kadee standard long-shank couplers that I would install.

UNDERFRAME DETAILS

It's funny to me the bulk of the details to this car are on the side you see the least: the bottom [9]. I began by adding weight to bring the car up to NMRA standards for its length, carefully cut and shaped to blend in.

I then added custom long brake rods with hanger brackets I made from flattening 0.019" brass rod. I added air piping (not prototypical) that might be seen on eye-level layouts. I also custom-made a plastic fulcrumed cylinder level, detailing it with 40-link-per-inch brass chain.

FINAL CAR COLOR AND FIRST WEATHERING TECHNIQUE

As discussed in the backstory, I wanted this model to represent a car that has taken abuse. It needed to have paint chips and



9. I installed many custom-made brass detail parts to the bottom, as well as custom weights. This car meets all NMRA standards for HO scale.



damage from errant forklifts loading and unloading lumber, and from the wood itself.

At this point, the build portion of the car was complete. I had applied the base coat of brown paint, and allowed it to cure. Next, I pump-sprayed liquid hairspray onto the car to serve as a basis for creating a paint-chipping effect.

I sprayed two thin coats of Floquil Reefer White to give the car its color. Floquil paint has a long cure time, which allowed for the more than four hours to chip and scratch the car. At the same time, the paint provides strong coverage that can hold up to tough scrubbing.

Immediately after spraying the white, I began the light paint-chipping process. I then used a short, stiff bristle brush to start scratching the white paint in various areas to represent damage from fork blades and bundle loads [10].

To help thin the white paint in areas, I soaked the brush with 99% isopropyl alcohol (IPA). Being mindful to randomly chip and remove enough topcoat paint allowed the reddish-brown base to show through with different hues.



10. The right side of the car. Right after the white coat was sprayed on, the paint chipping/scratching process began. Here, the car weathering started to pop.

WEATHERING IS NOT PAINTING

Prototype rolling stock receives damages, graffiti, rust, and dirt splatters differently on each side. I weathered the right side of the car more cleanly and lightly [10], but made the left side darker and rustier for contrast [11]. I continued the same paint chipping process on all sides of the car to better tie everything together overall.

The second weathering technique I used on this car is a combination of two dry-pigment colors (white and rust brown) scrubbed in with a stiff brush in various random patterns. I used pan pastel weathering powders for this next weathering technique. I rubbed the white on, then used a second IPA-soaked brush to change the powder into more of a thin stain for a different hue in areas of the car.

After the car side had dried, I scrubbed on the rusty brown color. and then with a brush dampened with IPA, slowly cleaned up various brown areas to reveal more of the white. One fun technique of weathering is to remove and move around the weathering you've already put on [11].



11. The left side of the car. I used rusty brown pigments to create a rustier effect. I also used IPA in places to remove pigments and topcoat paint in layers for a different hue.



ADDING THE CABLING

The car has dozens of holes for stringing cable on 18 posts along the center beam. I used white thread for the cable so I could color it randomly for an aged look.



12. Right side view, with decals and cables added. I ran the cables from the holes, then around the spools and back through the holes to the other side of the car. See if you can follow the pattern I chose.



13. Closeup left side end view. The coiled-up cable on the deck will be a conversation piece for rivet counters.

I strung up all 36 cables in one continuous piece, and superglued the thread to the first/last spools [12]. For conversation and to drive those OSHA fanatics crazy, I coiled up a little bit on the deck [13].

Once I had run and placed the thread, I used the remaining colored IPA on my palette tray to stain wash various parts of it. I forgot to coat the thread with a little beeswax afterwards so it wouldn't fray. My bad.

DECALS

The decals I used for this car are Microscale decals, luckily, I had on hand. I used bits and pieces from three different bulkhead flat car sets. This was mostly because one standard sheet wouldn't fit in the extraordinarily narrow side frame channels [14].

It doesn't matter which decal sets I used. I used what I thought looked right, without any idea if they're even in the right place. I don't count rivets anymore for a fictitious car the way I did as a kid.

THE TRUCKS AND UNDERFRAME

I kept the car's original trucks because they were nicely detailed, had metal wheels with pointed metal axles, and spun well with



14. Left side view with cables strung and decals applied.



low friction. I weathered up the trucks and thinly painted the trucks the same weathered black I was painting the underframe, letting the other two colors show through.

I started weathering the bottom with a rust color. Then, looking at the clock, I saw the hour was getting late, and decided to stop weathering the underside of the car, which would only be seen



15. The underside was quickly painted a weathered black coat and I started to add rust, but quickly decided to use the “good-enough” rule since I knew the underside would seldom be seen.



16. View of B-end of car.



17. Head-on B-end view. Note the several added brass details. Uncoupling lever, see-through crossover platform, brake chain with brake bell crank that the chain curves 90°, grab irons, and a rubber air hose with angle cock.



18. Left side view. I think the custom-made coupler lift bars add a little something to the car's overall look. The crossover platforms hide the long coupler shanks nicely. The long couplers allow the car to negotiate 22" curves without problem. I don't build or test for anything tighter.

Get more articles like this

GIVE IT A LIKE



REGISTER
(free)

[INDEX](#)

[TABLE OF CONTENTS](#)



19. A-end angled side view.



20. A-end view. The custom-made grab irons look much better than the original flush molded-on ones.



21. Closeup right side angled view.



22. Looking down on the right-hand deck. I find the scratches and pooled-up grime and rust weathering interesting.



23. Closeup right-side inside the car end. The cable starts on the spool at left.

rarely anyway. I learned this “good enough effect” from the late modeler Allen McClelland’s articles [15].

EYE CANDY

The following photos are angled and closeup shots of what I think is an interesting finish to an otherwise unwanted, undecorated car. Modeling is simply one’s imagination set loose on a blank canvas [16-23].



REGISTER
(free)

[INDEX](#)

[TABLE OF CONTENTS](#)

CONCLUSION

Detailing this undecorated Walthers car turned out to be a lot of tedious work, but it only took around 15 hours over three days. I'm glad I could give this unwanted car a purpose. I know it will bring miles of smiles and hours of conversation. I hope this gives you some ideas with your next bulkhead flat car build. ☑

THOM DRIGGERS



Thom is the owner and builder behind Thom's Custom Trains. He lives in Massachusetts with his long-time girlfriend Luba for the last 20 years. He has been modeling since the mid-70s. His professional career and modeling business both have been around railroading, either prototype or modeling. He is an avid brass collector and builder. Luba loves to take train trips. She is retired now, and Thom is semi-retired at age 60. ■



**Please click on the ads to
support MRH!**

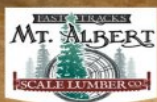

Introducing THE LUMBER STORE



ROTATING STORAGE RACK

On its own, or fully loaded with Mt. Albert Scale Lumber!

handlaidtrack.com

1-888-252-3895

Do ALL your model railroading friends know about MRH?

WE CONTINUE TO BE SURPRISED BY HOW MANY
MODELERS STILL HAVE NEVER HEARD OF US - SO
SPREAD THE GOOD WORD ABOUT MRH!



REGISTER
(free)

[INDEX](#)

[TABLE OF CONTENTS](#)

Casting your own log buggy cars



Model Railroad Hobbyist | December 2023

1. You can buy these log buggies from Star Hobby (link in article shopping list), or you can learn to make your own unique variations using the casting techniques in this article.



BERND FANGHANEL SHARES TIPS AND TRICKS FOR CASTING YOUR OWN UNIQUE MODELS ...

IN THIS ARTICLE, I focus more on the process of casting than building an actual model. I'm assuming you will develop your own plans and design your own casting masters. Using these casting methods, you can then cast as many as you want.

HOW LONG DOES THIS TAKE?

Once you've made your master and have a mold, it takes 15 minutes for the resin to cure in a mold. Figure 20 minutes per car, so 3 cars per hour. Add cleaning the castings and the assembly time to that.

If saving money is your main motivation, then I'd say for six or fewer cars, casting will not pay for itself. But if you want a dozen or so, and perhaps you also have some club members wanting these models, then casting a car body can be quick and easy. Vendors such as Grant Line offer great parts to add to the main body.

If the specific car you want is available commercially, it will be cheaper to buy it. Casting is best for when you need several of the same model, and can't buy it. As a matter of ethics, it's best to scratchbuild your own mold masters; don't use commercial models as mold masters.

This process can be applied to all scales for mass-producing hard-to-get cars or for modeling anything else you can think of on a model railroad. No need to limit it to just rolling stock.

MAKING A MASTER

For this example, I show making a master for my own custom On30 log buggies.

First, I made the master for the log bunk center sill. I used three pieces of wood glued together to form the proper width and length.

For the middle of the car's spine, I'm using a piece 10" x 10" square by 14' long. (I'm giving all dimensions in prototype scale feet and inches.)

The two outside pieces are 6" x 8" by 18' long. I cut two slots toward the center [2, A] and two at the end in the 10" thick middle section to provide space for the four brake beam hangers. I cut the other two slots [2, B] in between to leave space for the log bunks.

I cut square pieces of 0.010" thick styrene for washers, and added O scale nut-and-bolt castings on top and on the sides. The 2-foot end notches on each end provide room for a tight-fitting #5 Kadee coupler box.

Next, I fashioned two log bunks [3]. Each piece is 12" x 12" by 7'-0". I used 0.020" styrene strips to represent iron straps.



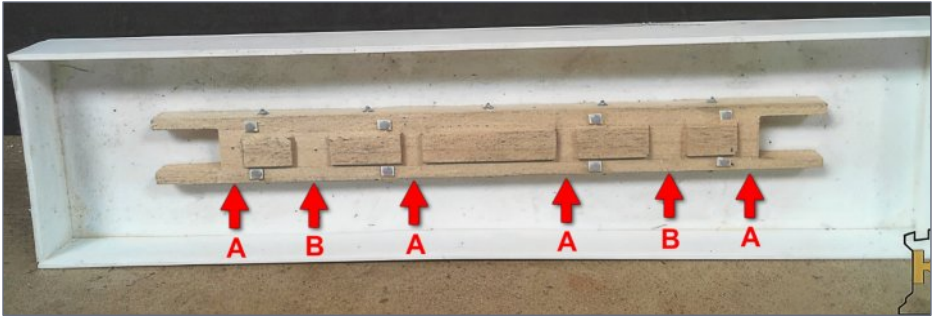

2. Master for the car's spine. Four spots marked A are gaps for the brake beam hangers, while the two spots marked B are gaps for the log bunks themselves. The end notches provide space for #5 Kadee coupler boxes.



3. Masters for the log bunks. By making two masters in one mold, I can cast both bunks needed to model one complete car as a single resin pour.

CAST YOUR OWN LOG BUGGY CARS | 4

Next, I made four brake beam patterns. Each piece is 4" x 6" by 4'-6" long, with four nut/bolt/washer castings on each. Each car needs four of these beams, and one mold has all that's needed for one car [4].

The last mold needed is for coupler plates. Each 18" x 22" plate is made from 0.020"-thick styrene. I added three 22" long strips made from 0.010" x 0.060" styrene across the top, plus seven nut/bolt/washer castings. Each car has four of these plates, two on top of the coupler box and two on the bottom.

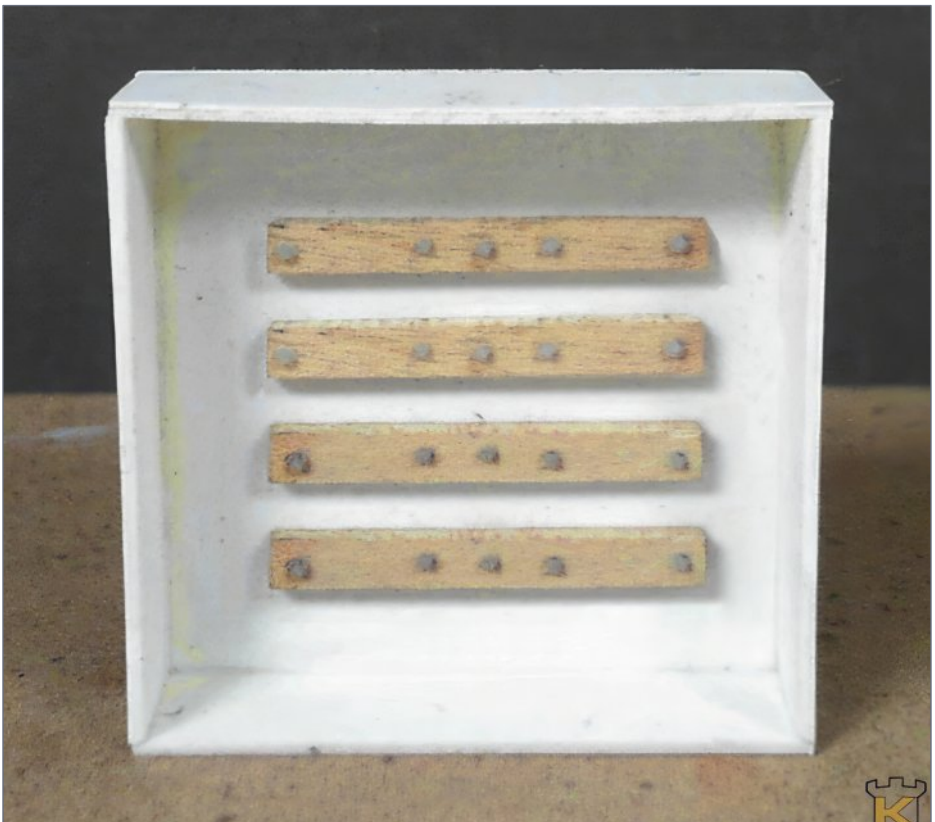

4. Brake hanger master with four brake hangers in all.



REGISTER
(free)

[INDEX](#)

[TABLE OF CONTENTS](#)



5. Finally, I made a master with four coupler plates.

MAKING THE MOLDS

I produced molds using an Alumilite silicone rubber casting kit (see the shopping list link at the end of this article). The rubber comes as two parts that need to be mixed. (I have recently started experimenting with Smooth-on products since they do not need degassing to remove air bubbles, see my side note).

I bought some 12 oz. paper cups and some Glad 4 oz, mini-round containers for mixing [6].

I marked one A and one B for the two-part mix [7]. Since they are a little too tall, I cut them down to a 2" height for better mixing.

Once cut, I marked a line about 1-1/2" up from the inside bottom of the cups [8]. I poured in equal amounts of part A in one paper cup and part B in the other cup. Then I poured both together into



6. Mixing containers: a 12 oz paper cup and Glad 4 oz. mini-round.



7. The 12 oz cups are too tall, so I marked them 2" up from the bottom and cut them off.



8. After cutting the paper cup to 2" tall, I measured 1-1/2" from the bottom on the inside and made a mark.



REGISTER
(free)

[INDEX](#)

[TABLE OF CONTENTS](#)



9. The spine/center sill mold.

the mini-round container, and carefully mixed the two parts until I had one smooth, consistent color.

Once I had mixed the mixture evenly, I stuck it in my vacuum chamber to remove air bubbles, then I poured it into the mold boxes. If you don't have a vacuum chamber, you can still make a rubber mold; you just need to be more careful to remove bubbles as you go (or try Smooth-On).

To keep bubbles from forming in the mold, one trick is to pour from a height of 12 to 18 inches above the mold. Pour it in a very fine, thin stream. Cover the whole mold in a thin layer of rubber. Then let it sit until no more bubbles are visible.

Trapped bubbles likely remain around details and in deep areas of the master with tight clearances between angled surfaces. Run a blunt-tipped toothpick around in those deep areas right after this first resin pour to dislodge those bubbles and force them to the top. This goes a long way toward improving your castings if you don't have a vacuum chamber.

Pour the rest of the rubber. I then wait 24 hours, pull the rubber mold out, and remove the master. Here are my molds for this log buggy [9-12].

THE CASTINGS

Photos [13]-[18] show the castings I made from the molds – molds which are now several years old. Unfortunately, the molds tore

CAST YOUR OWN LOG BUGGY CARS | 8

when I made these castings, so the castings didn't turn out as crisp as hoped. I'm now making fresh castings using new masters and Smooth-on products (see my side note).



10. The log bunks mold.



11. The brake beams mold.

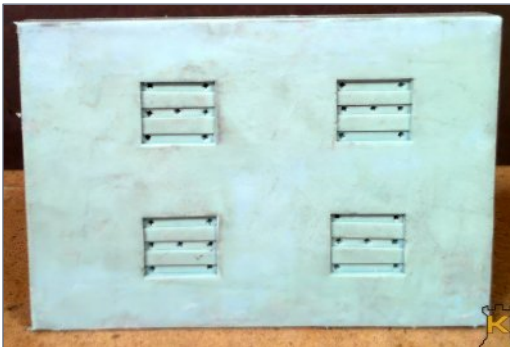

12. The couplers pocket covers mold.



REGISTER
(free)

[INDEX](#)

[TABLE OF CONTENTS](#)

Also see Jeff Johnston's side note on preventing mold tears.



J. Johnston

MOLD TEAR PREVENTION

Here are some suggestions on how to prevent molds from tearing.

First, check the proportions and material age. The materials can be a bit finicky about getting the proportions just right, and wrong proportions may result in the cured mold being too weak, and thus prone to tearing when you flex it to remove parts. Old rubber that has been sitting on a warehouse shelf for too long can also cause problems in rare cases.

Next, did you use some type of mold release agent before pouring the resin? That makes a huge difference in mold durability. I use solvent-based paint as a mold release on smaller parts, such as long bunks or small details, and simple spray can primer for larger pieces. The paint bonds to the resin and provides a pre-primed surface for painting the model later.

I let the paint dry for an hour or so before making the casting resin pour. Solvent paint dries quickly so an hour seems about right. If the paint wasn't completely cured, it's my guess that the heat generated by the curing resin would accelerate the paint curing. So far, I haven't had a cast piece come from the mold with any undried paint side-effects or damage.

If you're using a transparent release agent that's not visible on your cast parts, be sure it is fully compatible with the rubber mold and resin system. I tried a spray commercial mold release material, "Sprits General Purpose Mold Release EA," and darned if it didn't almost act like glue!

The stumps I cast had to be almost dragged from the mold instead of easily popping out using the solvent paint method. That was the end of my using Sprits mold release.

I've used some of my molds for 30-40 castings or more and they still look and perform like new. ■

CAST YOUR OWN LOG BUGGY CARS | 10

Here are my castings, which turned out well, but not as crisp as I had hoped. Time for some fresh new molds [13-16].



13. The spine/center sill.

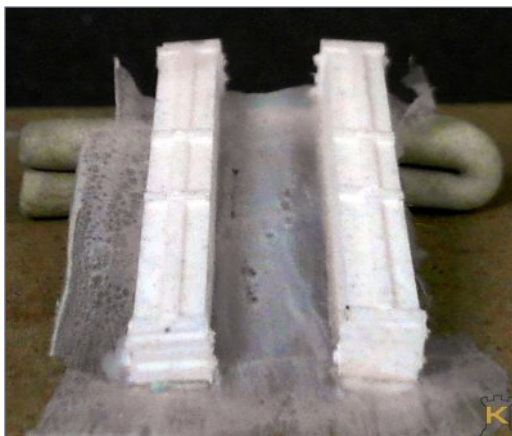

14. The log bunks.



15. The brake beams.



REGISTER
(free)

[INDEX](#)

[TABLE OF CONTENTS](#)



16. The coupler pocket covers.

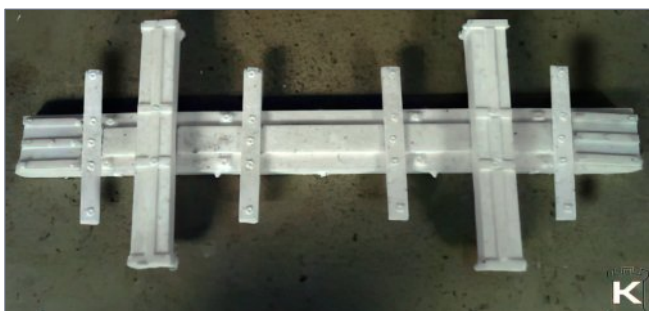

17. Parts assembled into the final car configuration.

ADDITIONAL CASTING TIPS

Here are some additional tips from the MRH forum on how to get the best results when casting.

- Since the rubber mold material can be somewhat expensive, a tip may be to fill the mold with sand first (as you would the liquid rubber). Pour that back into a cup. Brush the master and frame thoroughly to remove all sand grains. That gives you a good approximation of the amount of total material you will need. It can prevent mixing too much or not enough rubber.
- To make an easy box for your molds, you can use Lego blocks and glue them with hot glue on a flat piece of plexiglass. When the mold is cured, the glued Lego blocks can easily be snapped off the plexiglass and reused.

- Before pouring the rubber, brush all the inside “box area” with petroleum jelly (e.g., Vaseline) diluted with mineral spirits. This makes removing the solidified rubber mold from the box much easier.
- If you want a nice flat back to your resin castings, you can do that by putting a lid on the resin-filled mold. To make this easy, once the mold frame is full, pour some extra resin in a

BERND FANGHANEL



Bernd has been interested in model railroading ever since he can remember. He still has not built a layout. He belonged to the Kodak City Model Railroad (now Rochester Model Railroad) Club for several years, where he ran his equipment. At one time he was interested in 1½" scale live steam. Being interested in large scale required large-scale equipment to build it. Thus, he acquired a large milling machine and a lathe. Being also interested in home shop machining, he acquired several other metalworking machines of smaller size.

He finally settled on HO scale in 3' and 2'-6" gauges, as well a standard gauge. He has dabbled in TT and On30.

Bernd retired from Gleason Works, a major producer of gear-cutting machines, after 30+ years of service.

He and his wife live in upstate New York in a house he designed with a large basement for the New York, Vermont & Northern Ry, yet to be built. ■





B. Fanghanel

SMOOTH-ON CASTING PRODUCTS

Recently I have been experimenting with Smooth-On casting rubber and resin. A big feature of this product is its ability to avoid getting bubbles in your molds and resin castings. The Smooth-On instruction sheet says says the rubber and resin do not need to be degassed.

I use the same procedure as described to pour a thin stream from 12-18 inches above with both the mold rubber and the resin.

I don't need mold release for a one-piece mold like the log bunk mold. However, mold release is a must with a two-part mold like the archbar trucks here. If you don't use mold release on a two-part mold, you will never get the halves apart.

See the shopping list link at the end of this article for more.

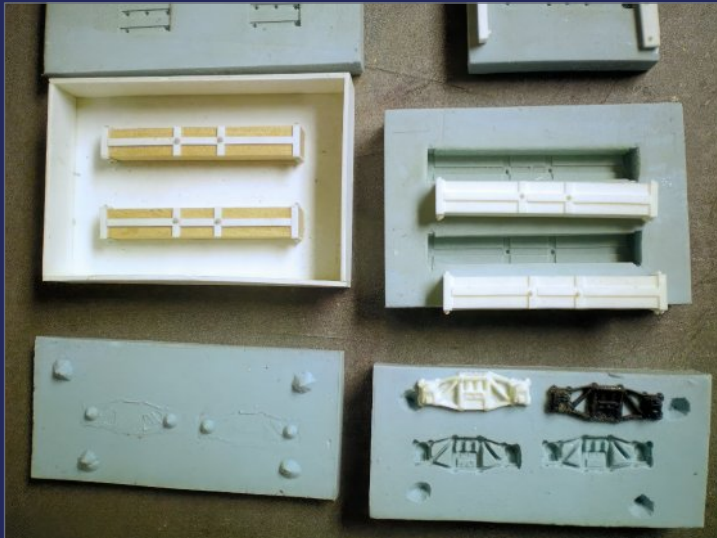

18. Single- and double-sided castings made using Smooth-on casting rubber and resin. There are no air bubbles.

line across one edge of the mold frame. Then take a rigid backer like a piece of clear acetate and dip the edge in that line of resin, then slowly lay the backer over the mold as though closing the cover of a book. This forces the still-liquid resin ahead of the cover and pushes the air and any bubbles out of the way. This is easier to do than to write about, and works quite well with flat-backed molds.

Happy casting! ☑

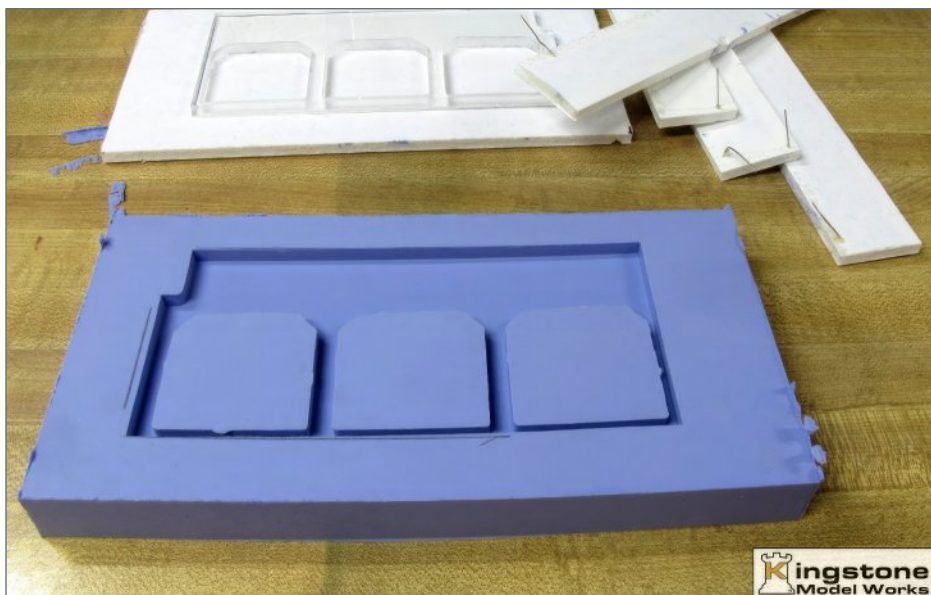

19. Another mold made with Smooth-On. Notice how clean and crisp it is, with no air bubbles.

Find this article's shopping list here:

mrhmag.com/magazine/mrh2023-12/log-buggies-shopping



NEW

from the
**Model Railroad
Hobbyist** *Store*

Running time:
3 hrs 16 min

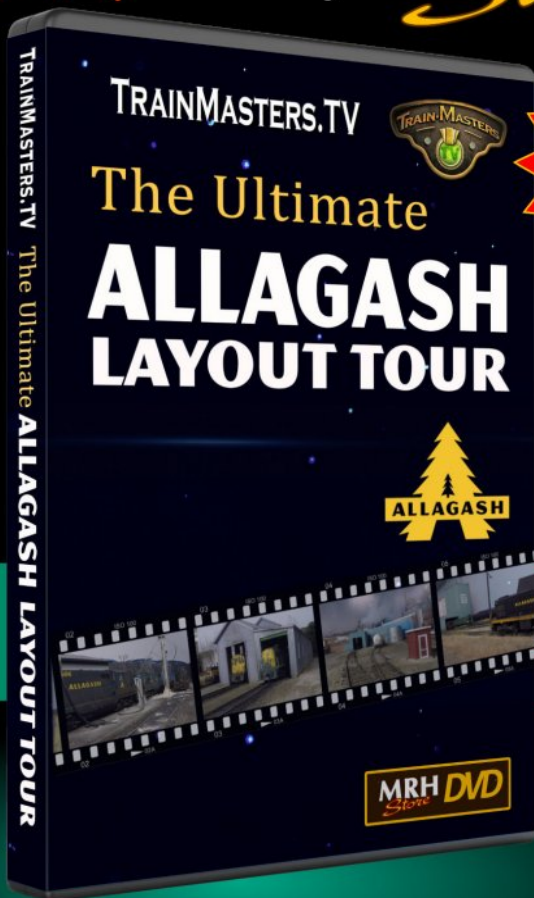

Watch a
preview

Download
~~\$19.99~~

\$9.99

DVD
~~\$30.00~~
\$21.77

Available NOW

Get Video
Download

Download in full 1080 HD

2-disk DVD set Available NOW

Get
2 DVD Set

DVDs: FREE SHIPPING US
50% OFF SHIPPING FOREIGN

WAIT!

**MRH helps
you avoid
breaking the
bank!**

SPECIAL DEAL:

Subscribe now and get
the next 12 issues plus
ALL 57 BACK ISSUES!



MRH **RUNNING**
EXTRA
Apprentice with savvy modelers

2.99 per 240+ pgs

**Get
MRH
Running Extra**

[click here](#)

 **REGISTER**
(free)

[INDEX](#)

[TABLE OF CONTENTS](#)

SAVVY MODELER *Online*



Get more articles like this

GIVE IT A **LIKE**



Model Railroad Hobbyist | December 2023



**WATCH
THE
VIDEO**
click here



Play this

Watch on



Modeling a waterfall scene

In this 45-minute video, YouTuber **Sandling Junction** details the step-by-step process he used to model this waterfall scene. He is especially thorough on the tricky modeling water part.

While this video runs long, we appreciate the extra depth. He unashamedly mentions his mistakes as well, helping us to avoid making those same faux pas. We find some techniques are particularly clever.



▶ GREAT MODELER VIDEOS ON THE WORLD WIDE WEB



Amherst Railway Society

presents

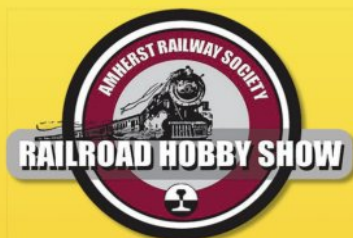

January 27 & 28, 2024

Eastern States Exposition
1305 Memorial Avenue
West Springfield, Massachusetts 01089

railroadhobbyshow.com

operating model railroads
railroad art and photography
railroad books and videos
model railroad clinics
family entertainment
tourist railroads
collectibles

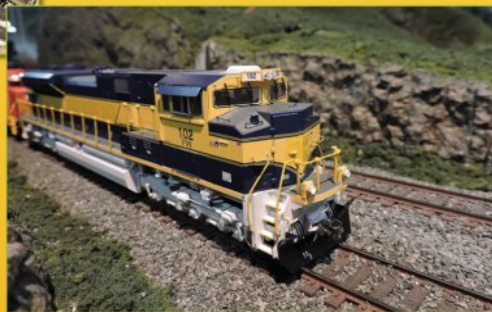

America's largest railroad-themed trade show



amherstrail.org

Eastern States Exposition is the home of the BIG E Agricultural Fair



REGISTER
(free)

[INDEX](#)

[TABLE OF CONTENTS](#)

DECEMBER NEWS

column



Model Railroad Hobbyist | December 2023

RICHARD BALE AND JEFF SHULTZ
REPORT THE LATEST HOBBY
INDUSTRY NEWS ...



INDUSTRY NEWS

JV Models, a producer of craftsman style structure kits sold under the brand names of JV Models and John Rendall Scale Models, has announced that it is closing effective immediately. JV Models was established in 1972 in Artesia, CA.

NEW PRODUCTS FOR ALL SCALES

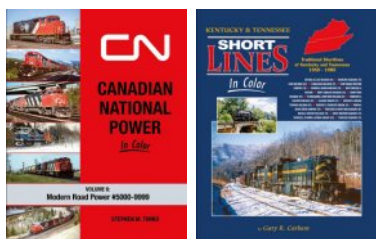

Morning Sun Books has released volume six of *Canadian National Power*. Edited by Stephen M. Timko, this new 128 page hardback book documents CN's modern road power in 16 all-color chapters.

Also new from Morning Sun is *Kentucky & Tennessee Short Lines* in which author Gary R. Carlson documents numerous little-known diesel and steam-powered short lines that operated until the 1950s and 1960s. Among those covered in the 128 page

THE LATEST MODEL RAILROAD PRODUCTS, NEWS & EVENTS

hardback all-color book are the Artemus-Jellico Railroad, Brimstone Railroad, Cadiz Railway, Carrollton Railroad, Chattanooga Traction, Corinth & Counce Railroad, East Tennessee & Western Railway, Flemingsburg & Northern Railroad, Frankfort & Cincinnati Railroad, Glasgow Railway, Kentucky & Indiana Terminal Railroad, Morehead & North Fork Railroad, Oneida & Western Railroad, Smoky Mountains Railroad and the Tennessee, Alabama & Georgia Railroad.

Info: www.morningsunbooks.com

O SCALE PRODUCT NEWS



Train Collectors Association. Roadnames in this special release are Chessie (B&O), Chessie (C&O), Conrail, and Penn Central.



Atlas has announced four paint schemes for the Master O Berwick 60' Hy-Cube boxcar, exclusively for the Metropolitan Division of the

The model features an ABS body, etched metal safety platforms, die-cast metal ladders and stirrups, die-cast underframe, 100-ton roller-bearing trucks with rotating

bearing caps, and simulated paint overspray on the roof.

Info: metca.org/store.html



Atlas has just announced a January 10, 2024 pre-order deadline for guaranteed delivery of a new production run of Premier streamlined passenger cars.. The 70' O scale 3-rail cars will be available in new paint schemes for release during the 4th quarter of 2024. The models can be ordered singly and in two- and four-car sets.



REGISTER
(free)

[INDEX](#)

[TABLE OF CONTENTS](#)

A four-car set of Delaware & Hudson cars will include a baggage car, coach, diner and observation car. A D&H two-car set will include a diner and a coach. A Vista Dome car will be available as a separate purchase.



An Erie Lackawanna four-car set will consist of a baggage car, diner and two coaches. A sleeper and a coach will be available in a two-car set. An RPO decorated for EL will be available singly.



New York Central cars will be available in a choice of 1938 or 1940 paint scheme. Each four-car set will include a diner, two sleepers and an observation car. An NYC two-car set will include an RPO and a sleeper.



A four-car set of NYC cars decorated for the Empire State Express will consist of a diner, observation car and two coaches. Additional coaches will be available in a two-car set.

A diner and three coaches will be available as a four-car set decorated for Maine Eastern. An individual coach will also be available.

Features of the Atlas O Premier cars include an injection molded ABS body with a metal floor, die-cast trucks with metal wheels and axles, constant voltage LED interior lighting, diaphragms, separate metal handrails and detailed interiors. The cars are designed to operate on O-42 curves.

Info: shop.atlasrr.com

HO SCALE PRODUCT NEWS

Accurail has released five new HO scale freight car kits including this Delaware & Hudson twin-bay coal hopper. The



model represents a car built new in early 1942.



This 40' riveted steel boxcar with double Youngstown sliding doors is based on a prototype built for the Milwaukee Road in April 1936.



Accurail has released a 3-car set of Cargill aluminum twin-bay covered hopper cars built by ACF. Single HO scale car kits are also available.



This 40' wood reefer is based on a prototype built with twin ice bunkers in the late 1920s. It is available now from Accurail in a 3-pack decorated for Nickel Plate Lackawanna Dairy Line, Boston & Maine and Chesapeake & Ohio.

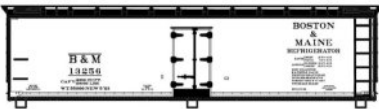

Pullman-Standard built the prototype of this triple-bay covered hopper car in 1966. Accurail's HO scale kit is available in a 3-pack with the reporting marks patched for ICE. All Accurail HO scale car kits come with appropriate trucks

with Delrin wheelsets and Accurail knuckle couplers.

Info: www.accurail.com





R. Bale

GE DASH 9-44CW LOCOMOTIVE

General Electric introduced its 9-44CW demonstrator in 1993. A new alternator resulted in 4,400hp – thus determining the locomotive's designation. Dubbed the Dash 9, the 4,400hp six-axle diesel road switcher proved to be a major success with more than 3,600 units being built through 2004. The Dash 9 was the first production locomotive to have a wide North American Safety cab as standard equipment. While similar in appearance to its Dash 8-40CW predecessor, the 9-44CW was built on a slightly longer platform to accommodate a massive 5,000 gallon fuel tank. Another spotting feature is the thicker radiator wings at the rear of the car body. Improvements over the C40-8 include a more reliable braking system, updated electronics, a larger engine radiator cooling system, and improved bolsterless high-adhesion trucks. The Dash-9 was superseded in the early 2000s by GE's Evolution Series locomotives.



Athearn has scheduled a new production run of GE Dash 9-44CW and 9-40CW

locomotives for release in April 2025. Special features on the Genesis series model include LED lighting with working number boards, ground lights, and front and rear walkway lights. Additional features include etched see-through walkway steps, uncoupling levers, MU and trainline hoses, realistic tread on the walkways, windshield wipers, lift rings, wire grab irons, Celcon handrails and fuel tanks detailed with fillers, gauges and a breather pipe.



Athearn Genesis Dash 9-44CW models decorated for Union Pacific and BNSF will

have 3-window cabs with high number boards and ditch lights at the front of the locomotive.



BNSF units wearing the Wedge paint scheme will have the same details except it will have a 4-window cab.

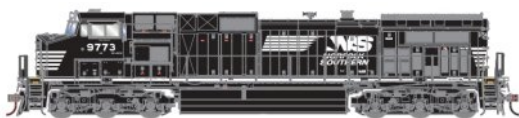

Features on Norfolk Southern's 4,000hp Dash 9-40CW locomotive include front and rear ditch lights, a K5 horn, and a headlight mounted high on the 3-window cab.



4-window cab, a K3 horn, front ditch lights, antclimbers, and front and rear headlights.

The Canadian National version of Athearn's Dash 9-44CW will have number boards mounted high on a



will both have 4-window cabs with low mounted number boards, front and rear marker lights, and front ditch lights.

Dash 9-44CW diesel models decorated for Quebec, North Shore & Labrador and Arizona & California



Athearn's Dash 9-44CW and Dash 9-40CW models will feature the Genesis driveline with a 5-pole skew-wound motor mounted on a heavy cast chassis with all-wheel drive and electrical pickup. A choice of operating systems include DC models equipped with a DCC-ready 21-pin NEM plug and DCC models with Onboard Economi sound/DCC from SoundTraxx. Athearn's HO scale Genesis Dash 9-44CW will negotiate track curves with an 18" radius, however, a minimum radius of 22" is recommended for more reliable operation.

Athearn's Dash 9-44CW and Dash 9-40CW models will feature the Genesis



REGISTER
(free)

[INDEX](#)

[TABLE OF CONTENTS](#)



R. Bale

EMD GP7 DIESEL LOCOMOTIVE

Introduced in 1949, the GP7 was the first model in EMD's general purpose (GP) series of locomotives. It was also the first EMD road locomotive to utilize a hood instead of a full car body design. Although narrow enough to allow outside walkways, the full height hood comfortably accommodated EMD's 1,500 horsepower 16-cylinder 567 diesel engine. The hood concept was an immediate success since it cost less to build, was cheaper and easier to maintain, and offered much better fore and aft visibility for the operating crew. When shopping for new locomotives, many railroads found it more economical to rebuild their reliable GP7s rather than to purchase new equipment.

Athearn has included a Genesis GP7 diesel road switcher in its April 2025 production schedule. New features include roof access hatches on locomotives without dynamic brakes.



GP7s decorated for Chicago & North Western are based on former Rock Island units with a unique all-weather cab window on the fireman's side. Additional spotting features include a flashing xenon strobe on the cab roof, new roof access hatch, and a 1,200 gallon fuel tank.



Burlington Northern GP7s have a cab mounted beacon, a firecracker type antenna, winterization hatch, and roof mounted steam era bell. The majority of BN's GP7s equipped with a 1,700 gallon fuel tank and roof mounted air tanks are former Northern Pacific units.



Amtrak's bright orange GP7s were second-hand units acquired for

maintenance-of-way service. With a 1,200 gallon fuel tank, the Amtrak units, known as Pumpkins, include a roof access hatch, partial skirting above the fuel tank, and prototype-specific wheel bearings. Front and rear flashing emergency beacons and flashing xenon strobes both function in DCC mode.



Athearn has included two versions of aging GP7s remanufactured and leased by Precision National Corp.

One unit has dynamic brakes while the second unit does not. Depending on the road number, Precision models have footboard pilots, 1,200 gallon fuel tanks, sunshades, firecracker antennas, and roof access hatches.

Completing Athearn's April 2025 production run of Genesis GP7s are three Erie-Lackawanna units set up for operation with the long hood forward. Details include canvas sunshades, curved spark arrestors, and two single-chime horns. The E-L units will be available both with and without dynamic brakes.



Undecorated GP7s will be available with and without dynamic brakes and a choice of

1,200 or 1,700 gallon fuel tanks. Availability will include DC models equipped with a DCC-ready 21-pin NEM plug and DCC models with Onboard Economi sound/DDC from SoundTraxx.

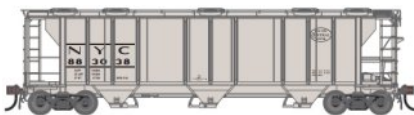

New road names and numbers for a PS-2 2893 cu. ft. triple-bay covered hopper are included in Athearn's April 2025 production

schedule. The HO scale Genesis model is based on a prototype introduced by Pullman-Standard in 1953. A spotting feature of the original design is the 4-3-4 pattern of the vertical side braces.



Separately applied details on Athearn's HO scale version will include round roof hatches, wire



REGISTER
(free)

[INDEX](#)

[TABLE OF CONTENTS](#)

grab irons, a photo-etched metal roof walk, coupler lift bars, brake and trainline hoses, and three fully-detailed outlets. Individual brake components include a detailed brake cylinder, valve and air reservoir.

Road names scheduled for the 2025 release are Jack Frost, Milwaukee Road, New York Central, Southern Pacific, Weyerhaeuser, Southern Railway and Wabash.



Short twin-bay covered hopper cars specifically designed to haul heavy dense lading such as sand, dry cement and other moisture-sensitive commodities, were

introduced in the 1950s. The concept was improved in the early 1960s when American Car & Foundry introduced the Center Flow design that combined a simplified gravity unloading system with a rounded car body that provided structural strength without the added weight of side bracing.



Athearn plans to release an HO scale version of the AC&F 2970 twin-bay Center Flow car in April 2025. Road names will include Chicago & North Western, Erie Lackawanna, Denver &

Rio Grande Western, Monon, Northern Pacific and Bay State Milling.

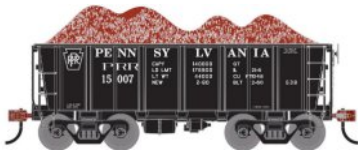

Also from Athearn is a PC&F 26' tight bottom ore car. Featuring updated body tooling, the cars include a removable ore load. Road names in

this release include Southern Pacific, Union Pacific, Canadian Pacific, Pennsylvania, Nacionales de Mexico, Cyprus Sierrita Corporation, and Data Only in mineral brown. A car decorated for Denver & Rio Grande Western is part of Athearn's Legendary Liveries line.



Roundhouse brand models coming from Athearn in 2025

include this 50' 5283 cu. ft. double door boxcar. The HO scale model is based on a 1970s prototype built by FMC with exterior posts, non-terminating ends and a pair of Youngstown sliding doors on each side.



Road names in this release will be SSW-Cotton Belt, Milwaukee Road, Golden West Service, Ontario Northland, Arkansas & Missouri and Coe Rail Inc.

All Athearn and Roundhouse models mentioned in this report come with McHenry automatic couplers and appropriate trucks with machined metal wheels.

Info: www.athearn.com

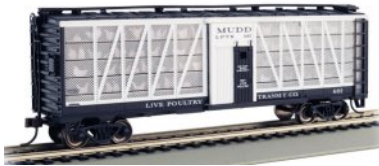

Bachmann Trains is shipping 40' poultry transport cars. Developed in 1884, transport cars were used as late as the mid-1950s. Designed for the comfort of the chickens and

turkeys being transported, the cars featured wire mesh sides and individual coops with feed and water troughs and an attendant that traveled on the car.



Some car owners gave their cars names, a tongue-in-cheek reference to the Pullman coaches of the same era. The cars feature blackened metal wheels and E-Z Mate Mark II couplers.

Info: shop.bachmanntrains.com



Broadway Limited has scheduled a January 2024 release date for several versions of a New Haven 4-6-4 class I-5 steam

locomotive. Like the 1937 streamlined prototype, BLI's HO scale version features gloss black paint with stainless steel stripes and trim.



The models have hand-crafted brass boilers, cabs and tender bodies, and die cast locomotive and tender chassis. Decorating schemes include the original block lettering, a choice of small or large script on the tender, and a fantasy McGinnis scheme. The I-5 locomotive will also be available unlettered in painted brass.



The model comes with Paragon4 Sound/DC/DCC sound system with synchronized puffing smoke and integral GoPack capacitors.

Info: www.broadway-limited.com



Home Shops has available Tangent PS-4427 covered hoppers decorated in freelance model railroad paint schemes. Paint schemes currently available

are Mike Confalone's Allagash, Dave Barrow's Cat Mountain & Santa Fe, Devin Jackson's Mesquite Belt, Neal Roggensack's Montana Northland, Brad Bourbina's Neosho Valley Lines, and Allen Whitaker's Tennessee Southern.

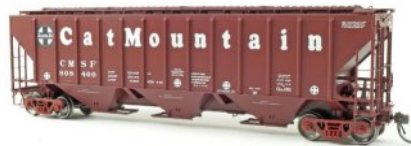

Each car number is a limited edition, with only 72 copies made. The details on the cars vary by freelance prototype and are the standard Tangent quality

and materials and include CNC-machined 36" meal wheels,

roofwalks and crosswalks, and Kadee metal couplers.

Info: homeshops.net



New **InterMountain** models recently released to dealers include an HO scale version of an X-29 boxcar. Road names include Maine Central, Baltimore & Ohio and Central Railroad of New Jersey.



Additional road names include Lehigh & New England, Pennsylvania Railroad (Circle and Keystone heralds), Chicago Great Western, Ferrocarriles Chihuahua al Pacifico and U. S. Army.



InterMountain is accepting reservations for guaranteed availability through December 31 for an HO scale PS2-CD 4785 cu. ft. covered hopper. A car with a ribbed roof hatch and standard discharge gates will be available decorated for New York Central. A similar CSX (ex-Penn Central) car will be available in IMRC's faded and patched paint.



Cars with a smooth roof hatch and standard gate outlets will be available for Cargill, Norfolk Southern, CSX (small logo), CSX (repaint, no logo), Burlington Northern (repaint, no logo) and Illinois Central. Ex-Conrail cars with Gravematic discharge gates and ribbed roof hatches will be available decorated for Penn Central and Burlington Northern.



InterMountain is booking reservations through January 31, 2024 for an HO scale Trinity 19,600 gallon tank car.



REGISTER
(free)

[INDEX](#)

[TABLE OF CONTENTS](#)

The new model is based on a 42' prototype introduced in 1984. The cars were designed to primarily carry sweeteners.

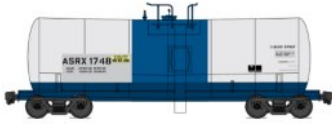

Decorating schemes on this first release will be DMIX-ADM, Gargill, GATX-Corn Products, Procor CASCO and ASRX-Domino Sugar.

Info: www.intermountain-railway.com



Kadee has released a 50' PS-1 boxcar decorated for the Chicago Rock Island & Pacific Railroad. The HO scale model replicates a prototype Pullman-Standard built in

1960 with a pair of Youngstown sliding doors covering a 15' opening on each side of the all-steel car.



The model has Pullman-Standard ends and roof, a metal running board, full height ladders, a Universal hand brake wheel, and Kadee self-centering HGC plain-bearing trucks.

Info: www.kadee.com



Rapido has completed another release of an HO scale Pennsylvania Railroad GLa class coal hopper. Introduced in 1904, PRR eventually owned nearly

30,000 of the GLa hoppers with more than 7,000 still in interchange service in 1960. Thousands more were owned by railroads other than PRR.



Rapido's HO scale model features full interior rivet and bracing details, wire grab irons, narrow semi-scale draft gear box and metal knuckle couplers.

Depending on the road names, trucks will be either arch bar or PRR 12D-F8. Both types of truck will have machined metal wheelsets.



Road names available on this release include PRR (Circle Keystone), PRR (Early), PRR (PRR Lines), PRR MOW Service (Yellow), Berwind (BWCX), Berwind (NRBX), Cumberland & Pennsylvania, Central of Vermont, Pennsylvania Coke & Coal and Buffalo Creek & Gauley.



Rapido is booking reservations for HO scale EMD and GMDD SW9 switcher locomotives. The hugely popular SW9 was purchased new by 69 railroads. From November

1950 to December 1953, nearly 800 SW9s were built at EMD's La Grange production facility, while in London, Ontario, GMDD rolled out an additional 29 units for the Canadian National and Canadian Pacific railroads.



Rapido's HO scale model of the SW9 features LED operating beacons or flashing lights as appropriate, a detailed cab interior, numerous see-through etched metal parts, heavy die cast frame,

die cast gear housing, metal couplers and Rapido's MoPower capacitor. The model will be available for DC silent operation (DCC ready with a 21-pin connector) or DC/DCC/Sound with an ESU LokSound V5 Decoder.



SW9 paint schemes include Santa Fe, Boston & Maine, Canadian National, Canadian Pacific, Erie-Lackawanna, Illinois Central, Louisville & Nashville, New York Central and Union Pacific. Unlettered models will be available

painted red or yellow. Availability and an order deadline are TBA. Info: www.rapidotrains.com



REGISTER
(free)

[INDEX](#)

[TABLE OF CONTENTS](#)

Scale Trains is working toward a mid-summer release of a GE AC4400CW diesel locomotive. The HO scale Rivet Counter model will accurately represent upgraded versions of GE's highly successful 4,400hp locomotive.



Units decorated for CSX will have low mounted number boards, ditch lights on the front deck, a Nathan K5HAR24 air chime and GE self-steering trucks.



Union Pacific models will be similarly equipped except they will have high mounted number boards and high adhesion trucks. Both red sill and yellow sill schemes will be available.



Scale Trains AC4400CW models decorated for KCS will have alternating ditch lights at both the front and rear of the locomotive, high mounted number boards and self-steering trucks. This version will be available in standard KCS scheme as well as in a NAFTA promotional scheme.



Ferromex units will be available in both Diablo and Zebra paint schemes. They will have self-steering trucks and ditch lights mounted on the front pilot.



Spotting features on Chicago & North Western AC4400CW diesels include high adhesion trucks and pilot mounted ditch lights.



Models decorated for the locomotive lease company CEFX (aka CITX) will have

details similar to the C&NW units except their front ditch lights will be mounted on the deck rather than on the pilot.

Scale Trains AC4400CW Rivet Counter models will be available for DC operation with a DCC-ready 21-pin connector, and DCC sound equipped with an ESU LokSound 5 sound decoder.

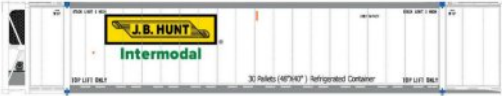

Scale Trains has also announced Operator HO scale CIMC 53' reefer

containers. Available in single and 3-packs, the single containers feature sound. First produced in the early 2000s, they are still in common use today. The CIMC containers are effectively identical to Hyundai refrigerated containers, so paint schemes for both are being offered in single and 3-packs. Single HO scale containers include sound while the containers in the 3-packs do not.



Roadnames and paint schemes include Alliance Shippers, CR England,

KLLM Transport Services, Go 2 Logistics Transportation Services, Hub Group, J.B. Hunt Transport Incorporated, Marten Transport, and Tiger Cool Express.

Info: www.scaletrains.com



Tangent Scale Models has released an accurate HO scale model of a PS PS-2CD 4427 cu. ft. high side covered hopper.

Tangent's PS4427 decorated for Santa Fe has Portloc gravity gates and Apex end crossover platforms. Twelve numbers are available in the 1966 as delivered paint scheme.



Chicago & North Western versions of the PS4427 have Miner gravity gates, a Universal

brake wheel, Pullman-Standard ribbed-style roof hatch and 100-ton Barber S-2 trucks with rotating Timken axle caps.



This Canadian National car represents a group of PS4427 hoppers acquired from Wisconsin Central. Parts

replaced along the way include Morton crossover platforms and new smooth-style roof hatches. The 2008 repaint included conspicuity striping on the sides and ends.



PS4427s decorated for Missouri-Kansas-Texas wear the as delivered bright red paint scheme. They are equipped with

Miner outlet gates, Apex crossover platforms and roof walk, and Barber 100 ton S-2 trucks with truck-mounted brake beams. An ex-MKT PS4427 is available patched for TLDX



This aging ex-MKT car is now owned by SIRX-Southern Illinois Railcar. Tangent is offering the model in one road number with

100-ton Barber S-2 trucks with rotating Brenco axle caps.



This Corn Products Company car represents a group of 16 PS4427s that retain several original 1967 details including

the square-step style on the corner ladders and center sill supports between the bays. The model is equipped with 100-ton Barber S-2 trucks with truck-mounted brake beams and rotating Hyatt caps.



The discharge bays on this NAHX car leased to Morton Salt are equipped with Youngstown EZ-Roll gravity gates.



This 1967-era PS4427 has a large round metal placard supporting the Cargill logo. The car has Miner gravity gates and ribbed-style roof hatches. It is equipped with 100-ton Barber S-2 trucks with brake beams and rotating Timken caps.

Details on all models mentioned in this report include near-scale draft gear boxes, see-through running boards, etched metal crossover platforms, six different outlet gates, two styles roof hatches, two different crossover platforms, wire ladder rungs and grab irons, wire coupler lift bars, separate air hoses, 100-ton Barber S-2 trucks with road name-specific rotating bearing caps and separate brake beam parts, machined 36" wheels with correct front and back detail, and Kadee couplers. Undecorated models are available RTR and in kit form.

Info: www.tangentscalemodels.com



New HO scale models coming from **Walthers** include this Trinity 25,000 gallon tank car. The Mainline series model is expected to be available next spring. The model is based on a prototype design that entered service in the mid-2000s. Features of the Walthers HO version include a separately applied manway, protective top filling housing with hatch, pressure relief valve, separately applied underbody wire safety rails, skid protected bottom outlet valve, steam inlet and outlet, correct brake equipment with cylinder and rods, train line and 100-ton roller-bearing trucks with 36" machined metal wheels. Decorating schemes in this release will be ADMX-Archer-Daniels-Midland, CRGX-Cargill, Santa Fe, GATX Corporation, BRCX-Bunge Corp, TEIX-Transportation Equipment and BNSF.

Walthers is preparing to release a new production run of 89' TTX 110-ton flatcars next summer. Based on a 2018 Greenbrier



REGISTER
(free)

[INDEX](#)

[TABLE OF CONTENTS](#)



prototype, the Walther's HO scale Proto series model will have dual tie-down chain channels on the deck, positionable container pedestals for hauling two 40' or four 20' containers, and separate nonworking cable straps and strap brackets. The model will have 100-ton roller-bearing trucks with 36" machined metal wheels.



Reporting marks available in this release will include TTX – TPDX (Military use), TTX – XTTX, TTX – JTTX, TTX – PTTX and undecorated.



New Walther's HO scale models scheduled for release during the winter of 2024 include this Thrall 53' steel gondola. The Walther's Proto series model replicates a rugged prototype introduced in the 1970s that still sees service today. The Walther's Proto series model features separate ladders and grab irons, detailed brake gear with separate handbrake and a see-through brake platform. The standard roller-bearing trucks are equipped with 36" machined metal wheels. Road names scheduled for this release include Illinois Terminal, Rock Island, Milwaukee Road, Soo Line, Norfolk Southern and Union Pacific. An undecorated model will be included in this release.

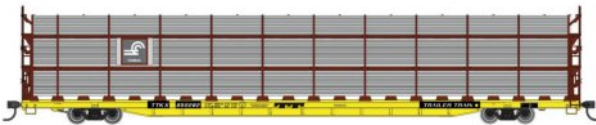

A new Walther's Mainline series 89' flatcar with a tri-level shielded auto rack is scheduled for release during the winter of 2024. The HO scale model represents a prototype auto carrier popular in the 1970s and 1980s. The Trailer-Train flatcar will feature a Paragon II style auto rack, die-cast metal underframe and 70-ton trucks with 33" machined metal wheels. The model will include swinging drawbars for 24" and larger curves and bridge plates for hobbyists wishing to apply them.

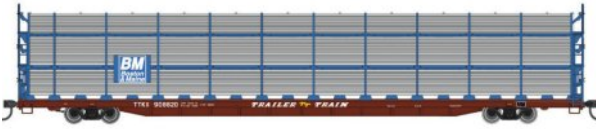

Auto racks decorated for Boston & Maine, Milwaukee Road and Southern Railway will

be mounted on a brown TTKX flatcar. Yellow TTKX flatcars will come with auto racks decorated for Erie Lackawanna, Chesapeake & Ohio and Conrail.



R. Bale

REPORTING MARKS ON SANTA FE WAY CARS

The standard name for a caboose on the Santa Fe Railway was Way Car. Between the mid-twenties and the demise of Way Cars, Santa Fe used three different reporting mark schemes to identify its equipment. Before 1938 Santa Fe reporting marks appeared as "A.T. & S.F." Beginning around the mid-thirties, Santa Fe applied a small car number to the front and back of the cupola of selected Way Cars. An order issued in 1938 directed that the ampersand be eliminated resulting in reporting marks of "A.T.S.F." The prevailing American attitude during WWII was save materiel, save on manpower, make-do with less. Accordingly the Santa Fe, as well as some other railroads, dropped the periods from its reporting marks. Repainting and stenciling did not happen overnight. Even when the effective date of a directive is known, it should be understood that completing the change in a roster of cars, even a relatively small fleet such as cabooses, required an extended period of shop time to accomplish.



Walthers has scheduled the release of a group of wood-sheathed Santa Fe Way Cars during the winter of 2024. The Walthers Proto series HO scale model will be equipped with a caboose version of an arch bar truck with elliptical springs and 33" machined metal wheels.



REGISTER
(free)

[INDEX](#)

[TABLE OF CONTENTS](#)



Decorating schemes will be available for A.T. & S.F (pre 1938), A.T.S.F (1938-1942), and ATSF (1943 to retirement). All of the Walthers models mentioned in this report will come with Proto MAX magnetic metal knuckle couplers.

Info: www.walthers.com

N SCALE PRODUCT NEWS



New road names and numbers for a PS-2 2893 cu. ft. triple-bay covered hopper are included in **Athearn's** April 2025 production schedule. The N scale model is based on a prototype introduced by Pullman-Standard in 1953. A spotting feature of the original design is the 4-3-4 pattern of the vertical side braces. Separately applied details on Athearn's N scale version will include separately applied round roof hatches, brake wheel and walkway.



Road names scheduled for the 2025 release are Jack Frost, Milwaukee Road, New York Central, Southern Pacific, Weyerhaeuser, Southern Railway and Wabash.



Short twin-bay covered hopper cars specifically designed to haul heavy dense lading such as sand, dry cement, and other moisture-sensitive commodities were introduced in the 1950s. The concept was improved in the early 1960s when American Car & Foundry introduced the Center Flow design that combined a simplified gravity unloading system with a rounded car body that provided structural strength without the added weight of side bracing.



Athearn plans to release an N scale version of the AC&F twin-bay Center Flow car in April 2025. Road names will include Chicago & North Western, Erie Lackawanna,

Denver & Rio Grande Western, Monon, Northern Pacific and Bay State Milling.

www.athearn.com



Broadway Limited has set a release date of January 2024 for a group of cryogenic tank cars.

The N scale models will be available singly as well as in 2-packs with unique road numbers.



Road names on this release will be Airco, Air Products, Air Reduction, Linde, UTLX (white and black versions). Big 3 and Canadian Liquid Air Company.



Individually applied details include hand rails, grab irons, ladders, brake housing, brake

wheel, M-T compatible knuckle couplers and roller or plain-bearing trucks as appropriate to the road name being modeled.

Info: www.broadway-limited.com



InterMountain Railway has released N scale versions of EMD F7A and F7B diesel locomotives. Both A and B units are powered and equipped with DCC with an ESU LokSound decoder.



Road names available now include MKT, Western Maryland, National de Mexico, Alaska Railroad, Great Northern and Union Pacific.



Additional new N scale models available from InterMountain Railway include a group of R-70-20 refrigerator cars.



REGISTER
(free)

[INDEX](#)

[TABLE OF CONTENTS](#)



The models represent a prototype built in the 1960s to handle perishable lading. Road names include Union Pacific, UPFE, SPFE and Santa Fe.



InterMountain is accepting reservations through January 31, 2024 for an N scale Trinity Industries 5161 cu. ft. triple-bay covered hopper car.



Road names on this release will be BNSF, Union Pacific, CSX, Ferromex, CITI Finance and GATX. The models feature etched metal roof walks and appropriate trucks with metal wheel sets. Availability is TBA.

Info: www.intermountain-railway.com



Jacksonville Terminal Company has released several new paint

schemes for the N scale 53' 8-55-8 corrugated high cube containers. Paint schemes in 2-packs include Priority Logistics, Milestone (ex-Universal patch), and Double Stack Logistics.



Paint schemes in 3-packs are Canadian Pacific and EMP (ex-Hub Group

patch). 6-pack paint schemes are J.B. Hunt, Amazon, Walmart, and Schneider.

Info: jtcmodeltrains.com

Kato USA is preparing to release new Gunderson Maxi-IV 3-unit articulated double-stack well cars next May. Kato's injection molded well cars will be produced using a heavy steel compound to stabilize operation both with and without a load of containers. Like the prototype, KATO'S N scale model can

handle containers from 20' to 53' in length with additional 40' to 53' containers on top.



Each 3-car Maxi-IV well car set will come with six 53' containers. A BNSF well car set will be available with a choice of six BNSF/NS HUB ribbed

containers or six CSX ribbed containers.



Options for a TTX well car set include six EMP ribbed containers or six Ferromex ribbed containers. The well cars feature two different sized wheels with 33"

wheels on the ends and 38" wheels on the two middle trucks.

Info: www.katousa.com



New N scale models from **Micro-Trains Line** include this PS-2 twin-bay covered hopper decorated for Pennsylvania Railroad. Built in 1957 by Pullman-

Standard, the 2,003 cu. ft. would become one of the most popular cars of its type. Many of the more than 400 cars built remained in revenue service into the late 1990s.



This 65' mill gondola with drop ends was built for Great Northern

Railway in the mid-1950s. Micro-Trains N scale version comes with a pipe load and roller-bearing trucks. The model requires a minimum 15" track radius.



This Micro Trains 60' excess height double plug door boxcar represents a prototype built by Berwick for the New

York Central. As a result of the NYC/Pennsylvania merger, ownership of the car went to Penn Central. The car was repainted after PC merged into Conrail in 1976.



Frank Wescott and Benjamin Winks founded Wescott & Winks Packers & Shippers Company in 1903. The company specialized in produce, butter, eggs and poultry. This 36' wood sheathed reefer with ice bunkers was built in 1927 and advertised W&W eggs.

Info: Contact a Micro-Trains dealer.



Scale Trains has announced Operator N scale CIMC 53' reefer

containers. First produced in the early 2000s, they are still in common use today. The CIMC containers are effectively identical to Hyundai refrigerated containers, so paint schemes for both are being offered in single and 3-packs.



Roadnames and paint schemes include Alliance Shippers, CR England,

KLLM Transport Services, Go 2 Logistics Transportation Services, Hub Group, J.B. Hunt Transport Incorporated, Marten Transport, and Tiger Cool Express.

Info: scaletrains.com

STRUCTURES & SCENIC SUPPLIES

Downtown Deco has released N, HO and O scale kits for Lennox Glass. The kit is composed of Hydrocal castings



produced from hand-carved masters. Additional components include Tichy and laser-cut doors and windows, signage, instructions. Assembly and

painting are required.

Info: www.downtowndeco.com



R. Bale

CAB-OVER-ENGINE TRUCKS

The first significant production of cab-over-engine (COE) trucks was by the White Motor Company in 1932. At that time the existing laws limited overall truck length to 42'. Placing the cab over the engine and front axle shaved several feet off the length of the tractor, which allowed the use of a longer trailer while keeping the overall length of the entire truck within the legal limit. The bodies for most COE trucks were initially produced by the Metropolitan Body Company (MBC) including International Harvester (IH), Chevrolet, Ford and Dodge until 1948 when MBC was acquired by IH.



Sylvan Scale Models

has released six different HO scale kits for 1940-47 Dodge COE trucks.

Body variations

include an REA delivery truck (with REA decals), stake truck, stake truck with canvas cover, gasoline tank truck, a highway tractor with a 5th wheel, and a cab with a basic chassis.

Each kit includes cast resin parts for the cab, front fenders and bumper, chassis and truck body. Additional parts include wheels



and tires, glazing material and photo etched stainless steel mirror/detail sets. Assembly and painting is required.

Info: www.sylvanscalemodels.com



REGISTER
(free)

[INDEX](#)

[TABLE OF CONTENTS](#)



Walthers is preparing a kit for an all-new combination station/freight house of brick and concrete construction typical of postwar designs. The HO scale model is

based on the Carolina & Northwestern Railway facility in Lenoir, NC. In railroad service from 1950 to 1994, the C&N structure is now on the National Register of Historic Places. The model includes a station and office area, a freight annex with a ramp and loading docks for both truck and rail. Assembly and some painting are required.

Info: www.walthers.com

NEW DECALS, SIGNS AND FINISHING PRODUCTS

Circus City Decals has HO scale water slide decals for 40' We Are One Ocean Network Express intermodal containers. Both pink and white versions are available. Lettering sets for HO scale Maersk 45' containers are also available. Each decal set will letter two containers.

Info: www.circuscitydecals.com

DISCLAIMER

The opinions expressed in this column are those of the writer and do not necessarily reflect the opinion of Model Railroad Hobbyist or its sponsors. Every effort is made to provide our readers with accurate and responsible news and information, however, neither Model Railroad Hobbyist or the writer of this column can be held responsible for any inaccuracies or typographical errors that may inadvertently appear in this column.

Get more articles like this

GIVE IT A LIKE



BRIEFLY NOTED AT PRESS TIME ...

A special run of **Atlas O** scale Burlington E-8 diesel units with Proto-Sound 3.0 digital sound, and a five-car set of matching 70' passenger cars will be available late this month exclusively from Mr. Muffin's Trains, Atlanta, IN. Info: www.mrmuffinstrains.com ...

Rail Smith is booking reservations for an N scale Alaska Railroad dome coach based on ex-Northern Pacific cars built by Budd with extra-large windows. Availability is planned for late spring 2024 ...

Rapido has extended the preorder deadline for its HO scale HEP and OCS E-units to March 15, 2024. Extending the deadline is due to delays in receiving decorated samples of the new models ...

Tangent Scale Models has announced the immediate availability of an HO scale Bethlehem 100-ton 3350 cu. ft. quadruple-bay coal hopper. Road names include Clinchfield, L&N, Seaboard System/CSXT and Wisconsin Central ...

New HO scale models coming from **Walthers** next spring include a Proto-series rib-side caboose in four Milwaukee Road schemes. The spring 2024 release will include Mainline series models of a Pullman-Standard 60' single-door auto parts boxcar and a 53' GSC bulkhead flatcar. New Walthers Cornerstone kits coming in 2024 include a two-story modern steel furniture factory and Golden Valley kits for a depot and a freight house... ■



REGISTER
(free)

[INDEX](#)

[TABLE OF CONTENTS](#)

SELECTED EVENTS



Model Railroad Hobbyist | January 2023

DECEMBER

Please check with any organization hosting an in-person event for the latest status of the event.

Ongoing 2023

ONLINE, Zoom, dates vary, see website. Operation Special Interest Group Meetups – limited attendance available.

Info: www.opsig.org/Virtual

Archive: www.opsig.org/Virtual/Past

ONLINE, Zoom & YouTube, Wednesday & Saturday, see Facebook page. “New Tracks” Meetup, hosted by Jim Kellow, MMR.

Info: newtracksmodeling.com

YouTube: www.youtube.com/channel/UCMA_VhPb5pjdkAYTdXLceJA

ONLINE, Facebook & YouTube, dates vary, see Facebook page. “NMRax” organized by Gordy Robinson, Martyn Jenkins, Gert Muller, Jordan Kramer.

Info: www.facebook.com/groups/nmragroup

ONLINE, YouTube, every other Saturday. 4th Division, Pacific Northwest Region, NMRA hosts online layout tours and clinics.

Archive: www.youtube.com/c/4DPNRMovies

ONLINE, Zoom, Second Tuesdays, 8pm Eastern. "Off the Beaten Track" featuring Narrow Gauge layouts, clinics, and manufacturers.

Info: groups.io/g/NNG

AROUND THE USA, IN-PERSON, Various dates. ScaleTrains.com Road Trip.

Info: www.scaletrains.com/roadtrip

December 2023 – January 2024

CANADA, ONTARIO, MARKHAM, December 16, 2023.

Railview Historial Society and Model Railroad free open house. 550 Alden Rd.

Info: www.railviewmodelrailwayclub.com or mike@theclares.ca

CALIFORNIA, ANAHEIM, December 15-16, 2023. Super Meet 2023, sponsored by the Toy Train Operating Society – Southern Pacific Division. Brookhurst Community Center, 221 W. Crescent Ave.

Info: ttos-sp.org/thesupermeet

MARYLAND, BALTIMORE, Wednesday to Sunday through December 31, 2023. Baltimore Society of Model Engineers Train Garden. Howard P. Rawlings Conservatory, Historic Druid Hill Park, 3100 Swann Drive.

Info: www.facebook.com/RawlingsConservatory

MASSACHUSETTS, ORLEANS, December 16, 23, 30, 2023.

Nauset Model Railroad Club Open House. Rear Lower Level of Hilltop Plaza, 180 Route 6A.

Info: www.nausetmodelrrclub.com

MASSACHUSETTS, WEST SPRINGFIELD, January 27-28, 2024. Amherst Railway Society Railway Hobby Show. The Eastern States Exposition Fairgrounds, 1305 Memorial Avenue.

Info: www.railroadhobbyshow.com

NEW JERSEY, SEWELL, January 20-21, 2024. Railroad Days at the Margaret E. Hegan Library, sponsored by the New Jersey Southern Model Railroad Club. 606 Delsea Dr.

Info: rick773@hotmail.com



REGISTER
(free)

[INDEX](#)

[TABLE OF CONTENTS](#)

WASHINGTON, TACOMA, December 22, 2023 – January 1, 2024. The 27th Annual Model Train Festival. Washington State History Museum, 1911 Pacific Avenue.

Info: www.washingtonhistory.org/exhibit/trainfestival-27

WISCONSIN, STEVENS POINT, January 20-21, 2024. Central Wisconsin Model Railroaders, Ltd 26th Annual Arctic Run Model Railroad Show & Sale. Holiday Inn Convention Center Hotel, 1001 Amber Avenue.

Info: cwmr_mnw@yahoo.com

Future 2024 by location

ONLINE, YouTube, March 18-21, NERx, the annual Northeastern Region, NMRA Virtual Convention.

Info: nerx.org and www.youtube.com/c/NMRAORGModelRailroading

ALABAMA, MOBILE, March 2-3, 2024. 2024 SWARM Model Train Show. Mobile Via Health, Fitness and Enrichment Center, Arlene F. Mitchell Campus, 171 Dauphin Street.

Info: Gasamuel@aol.com

ARIZONA, MESA, May 2-4, 2024. 2024 Sn3 Symposium. Sheraton Mesa Hotel at Wrigleyville West, 860 North Riverview.

Info: sn3symposium.com

CALIFORNIA, BAKERSFIELD, March 2-3, 2024. 30th Annual Bakersfield California Model Train Show, sponsored by the Golden Empire Historical and Modeling Society. Kern County Fairgrounds, 1142 South P St.

Info: gehams.club

CALIFORNIA, CROCKETT, February 10-11, April 13-14, June 22-23, August 24-25, September 14, October 26-27, December 7-8, 2024. Carquinez Model Railroad Society Open House. 645 Loring Avenue.

Info: cmrstrainclub.org

CALIFORNIA, LONG BEACH, August 4-11, 2024. Surfliner 2024 NMRA National Convention. Westin Long Beach, 333 East Ocean Blvd.

Info: surfliner2024.org

COLORADO, DENVER, April 6-7, 2024. Rocky Mountain Train Show – Spring 2024. National Western Complex, 4655 Humboldt St.
Info: rockymountaintrainshow.com/Default.aspx

KANSAS, HERINGTON, April 27-28, 2024. Herington Kansas Railroad Days Model Railroading and Railroad Memorabilia Show. Herington Community Building, 810 S. Broadway.
Info: heringtonhistory.org/heringtonrailroaddays

KANSAS, LAWRENCE, March 2-3, 2024. Lawrence Train Show, sponsored by the Lawrence Model Railroad Club. Crown Toyota Used Car Kingdom, 3400 S. Iowa St.
Info: lawrencemodelrailroadclub.org/TrainShow24.png

ILLINOIS, MACHESNEY, PARK, March 16-17, 2024. Rock River Valley Train Show. Harlem High School, 9229 N. Alpine Rd.
info: www.rrvd-nmra.com

MARYLAND, TIMONIUM, February 3-4, 2024. Great Scale Model Train and Railroad Collectors Show & Railroad Marketplace. Maryland State Fair, 2200 York Rd.
Info: www.gsmts.com

NEW YORK, HAMBURG, February 17-18, 2024. WNYRHS Train & Toy Show, sponsored by the Western New York Railway Historical Society. Fairgrounds Event Center, 5820 South Park Ave.
Info: wnyrhs.com

OREGON, ELSIE, April 6, 2024. Pacific Model Loggers Congress, Camp 18 Restaurant and Logging Museum, 42362 Highway 26.
Info: pacificmodelloggerscongress.org

PENNSYLVANIA, MALVERN, March 22-24, 2024. Railroad Prototype Modelers – Valley Forge. Desmond Hotel Malvern, a DoubleTree by Hilton, One Liberty Blvd.
Info: www.rpmvalleyforge.com

PENNSYLVANIA, PITTSBURGH, September 11-14, 2024. 44th National Narrow Gauge Convention. Doubletree by Hilton Hotel Pittsburgh – Green Tree, 500 Mansfield Avenue.
Info: www.44nngc.com



REGISTER
(free)

[INDEX](#)

[TABLE OF CONTENTS](#)

SOUTH CAROLINA, EASLEY, February 16-17, 2024. Central Railway Museum's Model Train Expo 2024. Rock Springs Church – Impact Center, 207 Rock Springs Road.

Info: www.crmha.org/trainshow

TEXAS, PASADENA (Houston), February 17, 2024. 2024 Greater Houston Train Show, sponsored by the San Jacinto Model Railroad Club Inc. Pasadena Convention Center, 7902 Fairmont Parkway.

Info: sanjacmodeltrains.org

WISCONSIN, MADISON, February 17-18, 2024. 56th Annual Mad City Model Railroad Show and Sale. Exhibition Hall, Alliant Energy Center, 1919 Alliant Energy Center Way.

Info: www.nmra-scwd.org ■

Get more articles like this

GIVE IT A LIKE



in the **JANUARY 2023 MRH RUNNING EXTRA!**

Did you see this article?

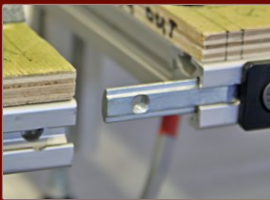

Building self-aligning modules

Get full eBook now ▶

← click here



Each eBook has 80-100 pages

MRH RUNNING EXTRA

READY TO SHIP
LIMITED QUANTITIES AVAILABLE

The Rapido GLa Hopper Car

**HO
SCALE**



The Perfect Duet

CP D10 STEAM LOCOMOTIVE



CONTACT YOUR RETAILER OR ORDER DIRECT AT RAPIDOTRAINS.COM



Quality. Style. Spirit.™

rapidotrains.com • [youtube.com/RapidoTrains](https://www.youtube.com/RapidoTrains) • [facebook.com/RapidoTrains](https://www.facebook.com/RapidoTrains)

RAPIDO



REGISTER
(free)

[INDEX](#)

[TABLE OF CONTENTS](#)

CLICKABLE ADVERTISER INDEX

[Accu-Lites](#)
[Amherst Railway Society](#)
[Atlas Model Railroad Co.](#)
[Bachmann](#)
[Backdrops only.com](#)
[Berrett Hill Trains](#)
[Black Cat Publishing](#)
[Blair Line](#)
[Coffman Graphics](#)
[Crew Call with Mike Rose](#)
[Crow River Products](#)
[Digitrax \(2 page spread\)](#)
[East Coast Circuits](#)
[ESU LokSound](#)
[Fast Tracks](#)
[Great Decals](#)
[Inter-Action Hobbies](#)
[Iowa Scaled Engineering](#)
[Litchfield Station](#)
[LocoFi](#)
[Logic Rail Technologies](#)
[Micro-Trains Line](#)
[miniprints](#)
[Model Railroad Control System](#)
[Model Rectifier Corporation](#)
[Monashee Laser Engineering](#)
[Monroe Models](#)
[MRH Store \(1\)](#)
[MRH Store \(2\)](#)
[Mt. Albert Scale Lumber](#)
[NCE \(2 page spread\)](#)
[North American Railcars \(PWRS\)](#)
[The N-Scale Division](#)
[Pre-Size Model Specialties](#)
[Precision Design Co.](#)
[Proto87.com](#)
[Rapido \(1\)](#)
[Rapido \(2\)](#)
[Ring Engineering](#)

[Rock Island Hobby](#)
[Roomettes](#)
[Scale Trains](#)
[Sceniking.com](#)
[Scott Antique Markets](#)
[SiskiyouLine.com](#)
[SoundTraxx](#)
[Southern Digital](#)
[Squeaky's Trains](#)
[Streamlined Backshop](#)
[TAM Valley Depot](#)
[TrainMasters TV](#)
[Westerfield](#)

Did you see this article?

in the **NOVEMBER 2023 MRH RUNNING EXTRA!**



Build an animated lift bridge

Get full eBook now ►

click here

MRH **RUNNING**
EXTRA

Each eBook has 80-100 pages

Clickable “other” index
[Other – Contents](#)
[Other – Cover](#)
[Other – MRH Marketplace](#)
[Other – MRH Sponsors](#)

Coming next month in MRH ...

The best from 15 years of MRH Forum Weekly Photo Fun photos ...



Modeling realistic haystacks ...



Making Walthers/Shinohara turnouts DCC-friendly ...

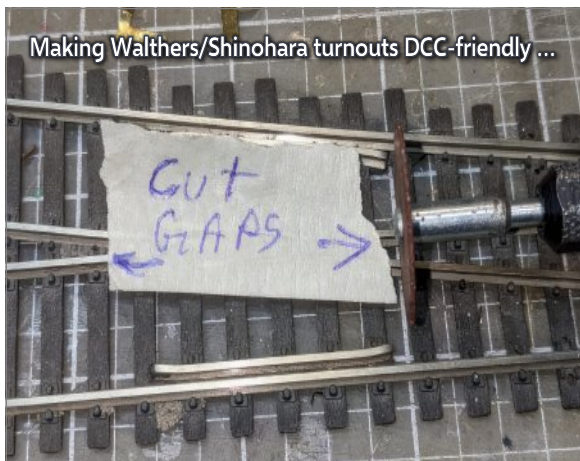

... coming January 15th in the
January MRH

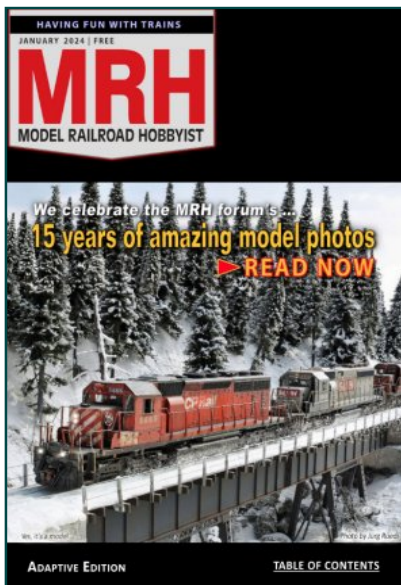

REGISTER
(free)

[INDEX](#)

[TABLE OF CONTENTS](#)

Coming next month in Running Extra ...

... all the MRH articles and ads, PLUS:

Jim Six analyzes Robin Moutenay's one-town Pennsy layout ...



Modeling a military train ...



January 2024 - \$2.99

MRH **RUNNING**
EXTRA
Apprentice with savvy modelers

Jim Six analyzes Robin Moutenay's ...
One town Pennsy layout
▶ READ NOW

Also these articles:

- Lorem ipsum dolor sit amet
- Consectetur adipiscing elit morbi
- Vestibulum tempus vehicula
- Mauris tempor libero ipsum pellentesque
- Nullam porta ut arcu at lobortis

... and much more!



MRH looks at new & improved
N scale flex track ...

... all this and much more!

SUBSCRIBE AND SAVE UP TO 80%