

HAVING FUN WITH TRAINS

NOVEMBER 2023 | FREE

MRH

MODEL RAILROAD HOBBYIST

ALSO:

- Wiring for DCC guidelines
- Modeling a cattle stockyard
- Finishing the HO_n3 project layout
- Scratchbuilding telephone poles
- ... *and more inside!*

Richard Bale documents

100 years of diesel loco trucks

1924-2023

▶ READ NOW



Includes bonus download:
Table of all diesel locos and
what trucks they came with

Proto:48 model and photo by Edmund Nadolski

ADAPTIVE EDITION
Landscape or Portrait depending on screen size



DOWNLOAD

TABLE OF CONTENTS

This is the screen-adaptive PDF version of MRH magazine

This PDF will try to fill the screen. If the screen is wide enough, it displays two facing pages (emulating the old landscape format), otherwise it displays one page in portrait.

On mobile devices, if you change your device orientation, the PDF adapts to fill the screen with either a portrait or a landscape view as appropriate.

WORKS BEST WITH ...

- Windows: open with Acrobat or Firefox
- Mac: open with Preview, Acrobat, or Firefox
- Linux: open with Acrobat or Firefox
- Apple iPad or iPhone: open with SideBooks app (free)
- Android tablet or phone - open with SideBooks app (free)

If you're not seeing the PDF adapt, then your PDF viewer lacks the adaptive display feature. Please use one of the recommended free PDF viewing apps listed above to get the screen adaptive behavior. Or try the Wide Edition instead.

Now Available from



#2712 - N Code 55 11.25" Radius Full Section



#2540 - Track Nails

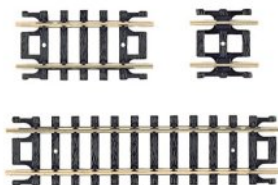

#2509 - N Code 80
Straight Snap-Track® Assortment



#2705 - N Code 80 #6 Remote Switch - Right



#70 000 102 - N Scale Signal,
Type G, Single Head

#2500 - N Code 80
Super-Flex® Track

ATLAS HO & N SCALE TRACK PRODUCTS IN STOCK & AVAILABLE NOW!



#0520 - HO Code 83
9" Straight Snap-Track®



#0750 - HO Lumber Yard & Office Kit



#0176 - HO Code 100
90 Degree Customline® Crossing

**GET ON THE RIGHT TRACK
WITH ATLAS!**

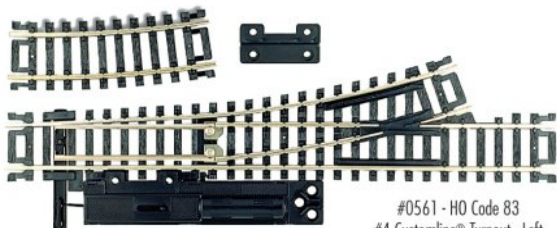

#0561 - HO Code 83
#4 Customline® Turnout - Left

CLICK HERE!

FOR MORE INFORMATION OR TO LOCATE A DEALER, PLEASE VISIT SHOP.ATLASRR.COM.
ATLAS MODEL RAILROAD CO., INC. • 378 Florence Ave., Hillside, NJ 07205



REGISTER
(free)

[INDEX](#)

[TABLE OF CONTENTS](#)

STAFF

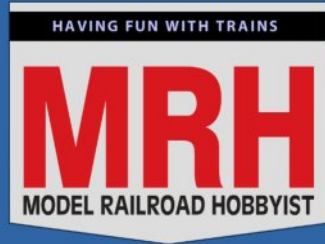

Model Railroad Hobbyist |

November 2023 | #165

Editorial Staff



Joe D. Fugate, Publisher and Editor



James Regier, Assistant Editor



Patty Fugate, Pasteup and Layout



Richard Bale, News and events



Jeff Shultz, News and events, Tech Assistant



Mike Dodd, Copy Editing

Get more issues like this

GIVE IT A LIKE



ISSN 2152-7423

V1.0 November 15

Advertising

Les Halmos, Account Manager

Jean-François Delisle, Marketing Assistant

Regular contributors

Eric Hansmann, Contributing editor

Jim Six, Limited Modeler column (RE)

Ken Patterson, Reporter-at-Large

Rotating Columnists (RE)

Greg Baker, Getting Real column

Al Daumann, Getting Real column

Jeff Johnston, Getting Real column

Mike Rose, Getting Real column

Jim Providenza, Getting Real column

Tony Thompson, Getting Real column

Published for the glory of God. [What's this?](#)

MRH SPONSORS



Model Railroad Hobbyist | November 2023

A - L



acculites.com



railroadhobbyshow.com



www.atlasrr.com



bachmanntrains.com

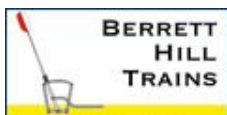

berretthill.com/trains



blairline.com



coffmaneng.com



deluxematerials.co.uk



www.digitrax.com



esu.eu/en



handlaidtrack.com



iascaled.com



litchfieldstation.com



wifimodelrailroad.com

[Vendors: Get your clickable logo on these pages ...](#)



REGISTER
(free)

[INDEX](#)

[TABLE OF CONTENTS](#)

M - Z



micro-trains.com



store.mrhmag.com



www.modelrectifier.com



handlaidtrack.com/mt-albert-scale-lumber



ncedcc.com



www.pwrs.ca/main.php



rapidotrains.com



ringengineering.com



rockislandhobby.com



scaletrains.com



scottantiquemarket.com



www.siskiyouline.com



soundtraxx.com



sodigi.com



sbs4dcc.com

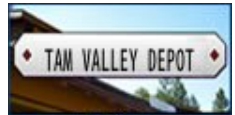

tamvalleydepot.com



train-fest.com



walters.com

Looking for something? Check the MRH Marketplace!



Take me there!

*You Have to be Kidding,
Right? Wrong.*



Handheld walk-around available, not included)

**MRC's Tech 6
Hybrid Runs
both DC and DCC.**

**CLICK
HERE
FOR
DETAILS**



MODEL RECTIFIER CORPORATION

360 Main Street, Suite 2, Matawan, NJ 07747 • Phone: 732-225-2100 • www.modelrectifier.com

FOUNDED BY ROY C. GELBER

■ Train Controls ■ Model Railroad Accessories ■ Plastic Model Kits ■ Scenery ■ Educational Kits



REGISTER
(free)

[INDEX](#)

[TABLE OF CONTENTS](#)



Publisher's Musings: MRH holiday season goodies ...
JOE FUGATE



MRH Website this month: Cardboard rolling stock, ...
Compiled by JOE FUGATE



What's Neat: HOn3 layout part 4 ...
KEN PATTERSON

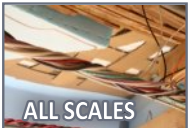

Electrical Impulses: Yes, wire size matters
MARK JUETT

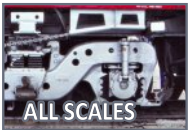

One hundred years of diesel trucks
RICHARD BALE



Kitbashing a cattle stock yard
DAVID NATION

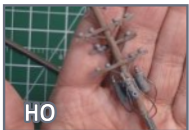

Savvy Modeler online: Scratchbuild telephone/power poles
Compiled by the MRH STAFF



November 2023 news and events
RICHARD BALE and JEFF SHULTZ



NOW ARRIVING

HO
1:87 SCALE

HERITAGE UNITS AND MORE



HERITAGE PAINT

REPLACEMENT PTC ANTENNAS

EVENT RECORDER

HIGH HEADLIGHT

FRONT AND REAR FLASHING DITCHLIGHT



CONRAIL



CENTRAL OF GEORGIA



INTERSTATE

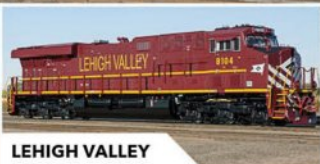

LEHIGH VALLEY



MONONGAHELA*



NICKEL PLATE



NORFOLK & WESTERN



NORFOLK SOUTHERN ORIGINAL



PENNSYLVANIA



SOUTHERN

Norfolk Southern Heritage Units

 DCC & Sound Equipped Retail: \$374.99 **Our Price: \$299.99**
 DC/DCC Ready Retail: \$249.99 **Our Price: \$199.99**

SCALE
TRAINS

ScaleTrains.com • 4901 Old Tasso Rd NE, Cleveland, TN 37312 • 844-9TRAINS 844-987-2467 • International 423-299-3689

© 2023 ScaleTrains, ScaleTrains.com, ExactRail, and respective logos are trademarks of ScaleTrains.com, Inc.

scaletrains.com

CLICK THIS AD

REGISTER
(free)
[INDEX](#)
[TABLE OF CONTENTS](#)

PUBLISHER'S MUSINGS

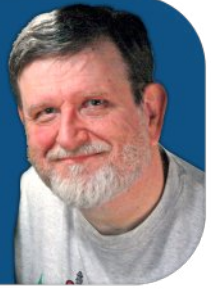

Model Railroad Hobbyist | November 2023



JOE FUGATE NEW GOODIES FROM MRH MEDIA AS WE ENTER THE HOLIDAYS ...

BELIEVE IT OR NOT, WE'RE NOW ENTERING THE HOLIDAY SEASON. It's hard to believe we're in the waning days of 2023 already!

MRH's holiday special

Before I reveal our holiday special, let me give a little background.

We have a total membership on our forum of around 67,000 registered readers – and they all know about our free *MRH* magazine where the pages all get paid for by ads.

But did you know we also offer *another* 6-8 articles per month in our additional *Running Extra* magazine that has no ads? This extra zero ads magazine is all meat and goes for just \$2.99.

To make it more convenient for our paid readers, we put the free MRH magazine in the back so one download gets it all each month. That's a total of around *250 pages per month* for just \$2.99. Just a tad over 1 cent per page.

Compare that to today's paper magazines running around 80 pages and costing \$8-\$10 per issue (10-12 cents per page).

Anyhow, I digress. If you want to subscribe to *Running Extra*,

we offer a new subscriber special of \$29.99 that not only gives you the next 12 issues, but gives you access to all 60 back issues. Do the math, that's less than 42 cents per issue, or *under two-tenths of a cent per page*.

At this price, the paper magazines want almost 100 times as much per page. Such a deal ...

To summarize so far, *Running Extra* is \$2.99 per issue, or \$29.99 for the next 12 issues and all 60 back issues.

Next, we have *TrainMasters TV*, our Internet subscriber video channel for model railroaders. We have 800+ videos out there now and add new videos each month.

A *TrainMasters TV* membership is \$39.99 per year, typically discounted to \$22.99. We also offer a monthly membership of \$4.99 if you prefer that. You get unlimited access to all 800+ videos as a member.

So if you get everything else we offer per month, the cost is:

TMTV: \$4.99 + *Running Extra*: \$2.99 = \$7.98 regularly

Our holiday special? You can get both of these for just \$2.99 per month. You're free to cancel any time, no problem. Links for the holiday deal are in the ad to the right.

What if you prefer an annual billing? Let's look at that.

TMTV: \$22.99 + *Running Extra*: \$29.99 = \$52.98 regularly

Our annual holiday special is \$2.99 x 12 = \$35.88. As a bonus, we throw in access to all the back issues of *Running Extra* as well. The link to this holiday deal is also in the ad on the right.

One important note on the annual deal: all sales are final. We will not issue a refund if you cancel the annual deal early. If this concerns you, we recommend you go the monthly route.





Holiday Sale

Running Extra + TMTV



... for one special price

MONTHLY

~~\$7.98~~

just

\$2.99 / mth

-OR-

YEARLY

~~\$52.98~~

just

\$35.88 / yr*

Get both RE + TMTV
for \$2.99 / mth ▶

Get both RE + TMTV
for \$2.99 / mth ▶

*Bonus: Includes access to all RE back issues



Our latest new book: Strates Carnival Trains

Our narrow gauge and shortline columnist emeritus Larry Smith (see older issues of MRH) approached us to be the publisher for his book on the history of the Strates carnival trains [1]. This book not only covers the history of these trains, but it has information on how to model them as well.

This book, titled *The last train standing*, has 235 pages and over 800 historical photos, both black & white as well as color.

See the ad on the right for how to get this book.

1. Here is our new book on Strates carnival trains by Larry Smith. The book is 235 pages with over 800 historical photographs in both black & white and in color. You can get the book as a downloadable eBook, as a paperback, or as a hardbound (shown here). This is our first hardbound book and we're pretty excited about it. More hardbound books are being planned. If you're interested in this book, check out the ad on the right.

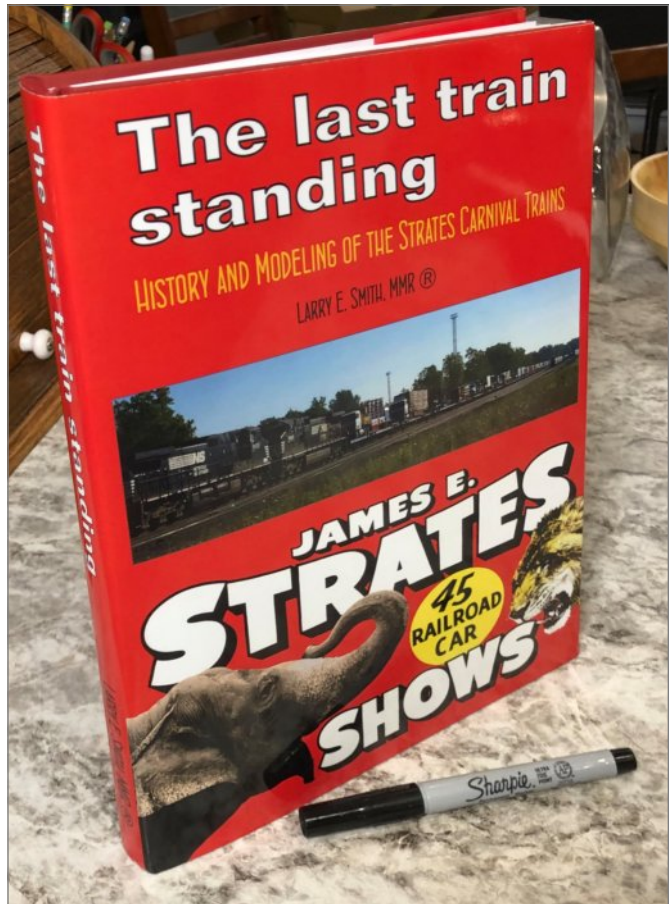

NEW from
the

**Model
Railroad
Hobbyist
Store**

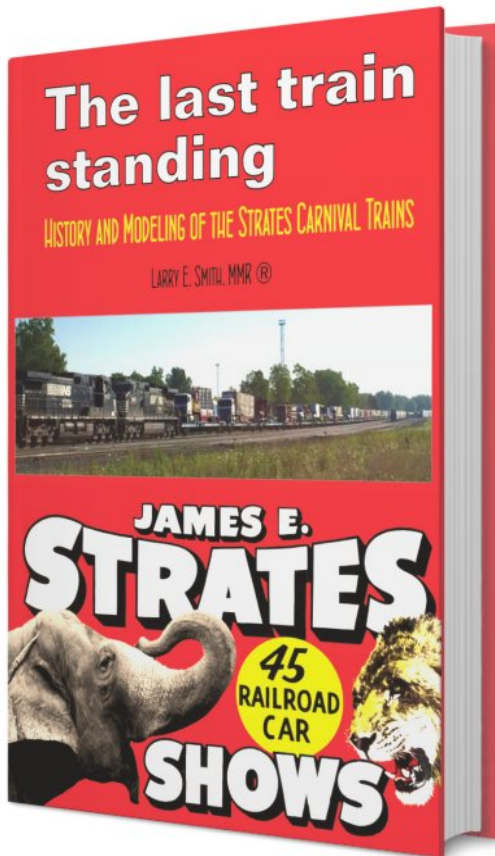

235
pages

800+
historical
photos

eBook • Paperback • Hardbound

LEARN MORE ▶

WEATHERED & GRAFFITI CAR REVIEW

Grab these and many more incredible weathered & graffiti cars today!



**MICRO-
TRAINS®
LINE**

CLICK HERE FOR MORE INFO

N
SCALE 1:160

PUBLISHER'S MUSINGS | 4

If you're interested in this book for historical research and/or modeling and want to get the paperback or the hardbound, consider also getting the eBook.

With the eBook, you can zoom the photos to be as large as you like, often finding details you may miss in the printed version photos.

New on the *MRH* forum: Rick's Diner

We think of you, our fellow modelers, as our extended family. That said, we run a pretty tight ship on the forum, riding herd on off-topic posts and splitting out threads when the discussion strays to far afield.

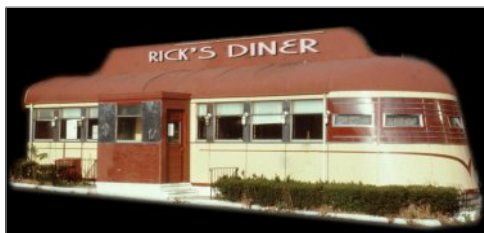

2. New Rick's Diner thread header.



REGISTER
(free)

[INDEX](#)

[TABLE OF CONTENTS](#)

Recently, it was suggested that we start a new monthly thread that's specifically for off-topic discussions. We think that's an interesting idea, so we have launched Rick's Diner this month, named in memory of *MRH* forum regular Rick Wade, who is no longer with us.

We think the off-topic thread will be fun, and it furthers the idea that we're all extended family. As long as we keep away from arguments over religion or politics, this thread will help us get to know each other better.

We also are having some fun of our own with this new monthly thread. Just like we make up history or stories for our layouts, we've made up some background about Rick's Diner.

To that end, please meet the waitresses at the Diner: Stella [3] and Flo [4].

Stella is more morose and has an edge to her disposition. It takes a lot to get Flo peeved, while Stella loves a good verbal sparring match with a wink wink to let her know you're just funnin' her.

"Right and Splice Clamps"™

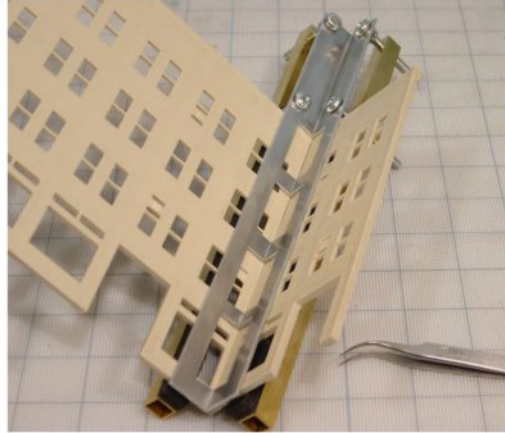

Quality Tools with Superior Versatility

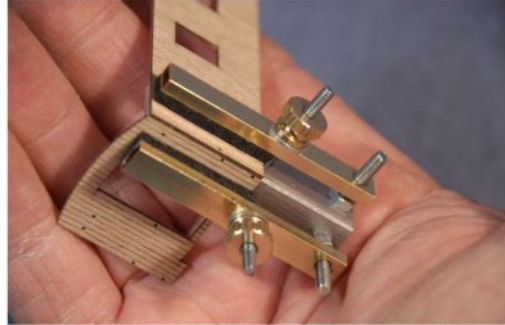

Essential Tools for Great Modeling

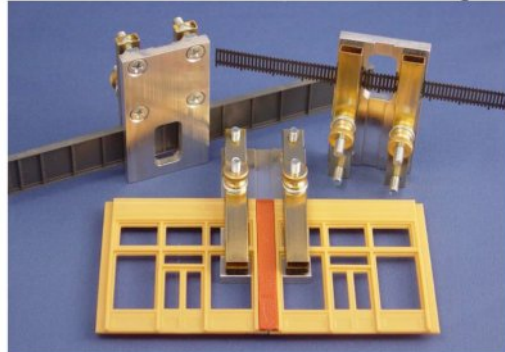

Coffman Graphic Solutions
1500 River Circle, Richmond KY 40475

Click Here

Visit our new Website:
www.coffmaneng.com



3. Rick's Diner waitress: Stella (Spice).



4. Rick's Diner waitress: Flo (Sugar).

Hey, it's all in fun, right? Just to add to the backstory on these two make-believe waitresses, we're assuming the regulars have nicknamed them Sugar (Flo) and Spice (Stella).

Stella has an interesting zinger method ... she'll put you in your place with music. Here's a recent example.

One fellow stopped every morning at the diner for breakfast on the way to work and had become a diner regular. One day, his work permanently changed his schedule and he now had to get up a lot earlier than before.

For the first few days of his new earlier schedule, this fellow complained to Stella that he absolutely *hated* having to get up so early for work.

After listening repeatedly to his sob story, Stella finally retorted, "I'm sorry honey that the world doesn't revolve around you." Then she walked off rolling her eyes and singing under her breath, "You're so vain, I bet you think this song is about you ..."

All the regulars have got the "You're so vain ..." song treatment at one time or another if they bellyache too much to Stella.



THE PERFECT HOLIDAY GIFT

for your favorite modeler, or just for you!



Walther's 2024/2025
Model Railroad
Reference Book
913-224 \$19.98
IN STOCK

WALTHERS

Support your local hobby shop • visit walthers.com • call 1-800-487-2467

© 2023 Wm. K. Walther's, Inc.

MRHMAG.COM

[INDEX](#)

[TABLE OF CONTENTS](#)

THE RAPIDO SD7 / SD9 / SD10 LOCOMOTIVE

HO SCALE



MoPower
UNINTERRUPTED LOCOMOTIVE POWER



LOK SOUND
EST. 1999

3D CAD Render shown. All art subject to revision before final production.

HO SCALE

Enterprise Hopper Car
PRE-ORDER NOW!

HO SCALE

PHR H&I Hopper Car
PRE-ORDER NOW!

HO SCALE

1937 AAR Boxcar
PRE-ORDER NOW!

HO SCALE

Northern Pacific "Day-Mite" Coach
PRE-ORDER NOW!

HO SCALE

Comet Commuter Cars
PRE-ORDER NOW!

HO SCALE

Northern Pacific Drop-Bottom Gondola
PRE-ORDER NOW!

CLICK HERE!



Quality. Style. Spirit.™

rapidotrains.com • youtube.com/RapidoTrains • facebook.com/RapidoTrains

RAPIDO



REGISTER
(free)

[INDEX](#)

[TABLE OF CONTENTS](#)

Flo, on the other hand, responded to the same fellow complaining about his early morning schedule woes with, "Baby, just be glad you're still breathin' and could walk in here with two good legs!"

Come visit the MRH forum

If you've not frequented the *MRH* forum, come on over and post a question or share some of your hobby progress.

And stop by Rick's Diner to tell us what's happening in your life outside the hobby lately. Remember to place your order, like this:

"Flo, I'll take a blueberry bagel with cream cheese and a tall cold orange juice."

Rumor has it, Rick Wade's friends [Buck and Loretta](#) sometimes drop by the diner now and then (wink).

Did you see this article?

in the **NOVEMBER 2023 MRH RUNNING EXTRA!**



More bulletproof layout details

Get full eBook now ▶ ← click here

Each eBook has 80-100 pages

MRH **RUNNING** **EXTRA**



Get more articles like this

GIVE IT A LIKE



Tell your friends about MRH!

**We depend on word-of-mouth to grow
... if you don't share us, we don't grow**

Every little bit helps!



Registered MRH readers
get **another** 10% off with
the coupon code here:

Reveal my
coupon code now!

[click here](#)

That's right, on top of our
other sales and discounts, use
this coupon code to get
YET ANOTHER 10% off!



The holiday
season is coming!



TMTV sale offers

[click here](#)



MRH Store sale offers

[click here](#)



REGISTER
(free)

[INDEX](#)

[TABLE OF CONTENTS](#)



LAST ISSUE LIKES

Most liked articles in [October 2023 issue](#) of *MRH* are:

- 1st** Scratchbuild a taxicab office
- 2nd** Publisher's Musings: MRH 2023 survey age results
- 3rd** Track planing with E-Z Track

Most liked articles in [October 2023 issue](#) of *Running Extra* ...

- 1st** Limited Modeler: Modeling coal customers
- 2nd** Building a rock face
- 3rd** Publisher's Welcome: Do modern locos need breaking in?

If you want more of this type article, then like the article!
Click the *Give us a like* or *comments* button on each article and press the like button on the article's forum page if you want to see more articles like these. ■

Get the latest Model Railroading News, Tips, Reviews & Opinions



**CHECK
IT OUT!**



**Our iTunes feed has changed search for
"Crew Call with Mike Rose" to receive the latest episodes!**

www.themodelrailroadpodcast.com

Host:

Mike Rose: www.mrhobby.com

**Don't Miss our Monthly Interviews
& Product Announcements**

In

MRH**RUNNING
EXTRA**

November issue ...

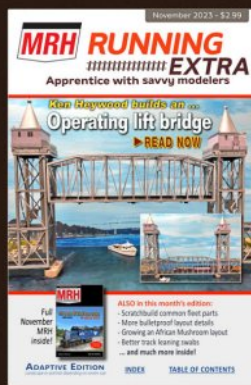
**TABLE OF CONTENTS | RUNNING EXTRA**

November 2023

**RUNNING
EXTRA****Publisher's Welcome: More bulletproof layout details**

JOE FUGATE

**Limited Modeler: The Royal Chair Factory**

JIM SIX

**Getting Real: Scratchbuild common fleet parts**

JEFF JOHNSTON

**Build an animated lift bridge**

KEN HEYWOOD

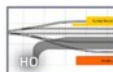
**Growing an African mushroom**

DAVID ERICKSON

**Ah-Hah Moment: Improved track cleaning swabs**

CHARLES HEPPERLE

Buy November eBook - \$2.99
93 pages

store.mrhmag.com

Also includes
170-page MRH
in the back!



REGISTER
(free)

[INDEX](#)[TABLE OF CONTENTS](#)

Best of the

MRH FORUM

Forum

MRH
mrhmag.com

**THIS
MONTH**

Model Railroad Hobbyist | November 2023

Compiled by **JOE FUGATE**



Cardboard rolling stock?

MRH forum member **arvanlaar** (Andrew V.) asked if anyone is still building rolling stock using cardboard? Among others, forum member **Dom Bourgeois** said yes and posted the photo above of his handiwork. Read the full thread for more!



[View the full thread on the MRH website](#)

▶ **MRH'S MONTHLY GREAT MODELER POSTS**



1. MRH forum moderator **Tim VanMersbergen** posted this photo of a lumber load he built using balsa wood blocks.

Scratchbuilding realistic lumber loads

MRH forum member **musgrovejb** (Joseph M.) finished building a bulkhead flatcar and went looking for ways to build a lumber load for it.

“Completed weathering a HO bulkhead flatcar and starting to look at options for realistic and prototypical lumber loads. As I model the 1970s, these loads would not be wrapped.”

Several responded to Joseph, and one of the more interesting examples came from **Tim V.** [1] as you can see in the photo above. Members also pointed out wrapped loads go all the way back to the 1960s, so modeling a wrapped load is not out of the question for a 1970s layout.

Read the full thread for the details!

[View the full thread on the MRH website](#)



[REGISTER](#)
(free)

[INDEX](#)

[TABLE OF CONTENTS](#)

**Available.
Inexpensive.
Realistic.**

**Autos with working
headlights**



and tail lights.

HO and N scale.

Realistic scale accessories—
automobiles, lights, figures,
scenery, military action rail
cars and more.

RIH
Rock Island Hobby

Click for Details:

www.rockislandhobby.com/collections/ho-scale

ADVERTISEMENT

Second Weekend, Every Month!
Scott Antique Markets

+++++ featuring +++++

**ANTON'S ANTIQUE
TOY & TRAIN SHOW**

**More shows
coming in 2024!**

WATCH FOR THE DATES ...

Atlanta Expo Centers

3650 & 3850 Jonesboro RD SE
Atlanta, GA 30354

For Full Schedule & Coupons
Visit our website.

www.scottantiquemarkets.com

MRHMAG.COM

[INDEX](#)

Siskiyou Line
Professional Grade Railroad Materials

Protect your locomotives & carry them safely.



AVAILABLE IN RED/WHITE/BLUE

1 Box \$39.95
Free shipping in Continental U.S.

SiskiyouLine.com

HO Loads,
Cars and Materials
Proudly Made in The U.S.A.

MRH & NMRA Discount
\$30.00 and free shipping!

ADVERTISEMENT

**Lasercut structures. Highway,
storefront and billboard signs.**

Neat ag customer for your railroad:
Farmers Fertilizer Supply



**WHAT'S
NEW?**



Established 1993...

Blair Line

[TABLE OF CONTENTS](#)



2. *MRH* forum member **BNML2** (Craig T.) provides a number of insightful tips for working with an air eraser on this forum thread.

Care and feeding of your air eraser

MRH forum member **BNML2** (Craig T.) started a thread to discuss getting the most out of an air eraser.

“I picked up an air eraser ... it worked great at removing the factory lettering on an Athearn Blue Box locomotive using baking soda [as a less expensive grit], until it didn't... I put it aside until recently, when I wanted to remove the lettering from some Walthers Superliner cars. It worked a bit, then it stopped working altogether. I stumbled across the reason: baking soda doesn't like moisture!”

Read the full thread where Craig (and others) share tips for getting great performance with an air eraser and save money.

[View the full thread on the *MRH* website](#)



[REGISTER](#)
(free)

[INDEX](#)

[TABLE OF CONTENTS](#)

NORTH AMERICAN RAILCAR CORPORATION



National Steel Car 5431 cu ft 3 Bay Hopper

“Grain Car Of The Future”



NARC has a long history of working with National Steel Car (NSC) in the research & development of our model railroad products.



The new cars can load 100 metric tons (tonnes) compared to old cars, which are limited to 90 tonnes. A tonne is about 10% heavier than a U.S. ton. The new cars are also shorter, allowing more cars per train (up from a typical length of 112 cars to at least 134 cars). These changes in efficiency will completely change the economics of grain distribution and transportation in Western Canada.



You may also notice the new car looks like a stretched version of our 4300 cu ft Potash car. See illustration here.



100	each train having	and each car loaded with
TRADITIONAL-STYLE TRAINS	112 cars	90 tonnes of cargo
= 75	each train having	and each car loaded with
NEW-STYLE TRAINS	134 cars	100 tonnes of cargo

HO N Pacific Western Rail Systems

Agrium | PotashCorp before...

...after **Nutrien**
Feeding the Future™

Merger Completed Forming Nutrien, a Leader in Global Agriculture

SASKATOON, Jan. 2, 2018 /CNW/ - Nutrien Ltd. (Nutrien) (TSX and NYSE: NTR) today announced the successful completion of the merger of equals between Agrium Inc. (Agrium) and Potash Corporation of Saskatchewan Inc. (PotashCorp), creating the world's premier provider of crop inputs and services. Nutrien has the largest crop nutrient production portfolio combined with an unparalleled global distribution network that includes more than 1,500 farm retail centers. With nearly 20,000 employees - and operations and investments in 14 countries - the company is committed to providing products and services that help growers optimize crop yields and their returns.



Nutrien (POTX) - National Steel Car Potash Service 4300 cu.ft. 3 Bay Covered Hopper

48 road numbers, available exclusively at:

Pacific Western Rail Systems

HO N

3. MRH forum member **ku7u** (George Hofmann) asked about how to apply decals to a lit number board and **dwilliam1963** posted a link to the ShellScale decals website. They have a pretty cool product, so we wanted to make our readers aware of their offering. On the right is the explanation from their website on how they make their decals (in both HO and N) so light will shine through them realistically. Check out the full thread for more (see text below).

How ShellScale Decals Back Lit Number Boards Work.



The diagram illustrates the difference between two types of number board decals. The top part shows a solid black rounded rectangle with the text "Solid Black Boards Don't Allow Much Light to Pass." below it. A horizontal line separates this from the bottom part, which shows a black rounded rectangle with white number boxes containing the digits "1597". Below this, the text reads "Black Boards With Number Boxes Allow More Light to Pass." The number boxes are shown in two rows: the top row has "1", "5", "9", and "7" in white on black backgrounds; the bottom row has "1", "5", "9", and "7" in black on white backgrounds, demonstrating how light can pass through the white areas.

Solid Black Boards Don't Allow Much Light to Pass.

Black Boards With Number Boxes Allow More Light to Pass.

Locomotive lit number boards

MRH forum member **ku7u** (George Hofmann) just finished a Stewart F3A and wants to light the number boards realistically. Among other things, he's asking how to find decals that will actually let the light shine through in a realistic way.

Forum member **dwilliam1963** (William D.) posted a link to a little-known hobby vendor that makes decals that address this problem: ShellScale number board decals - see forum for link. (*Maybe we can interest them in advertising? - ed.*)

We find ShellScale's solution to be well thought out and want to send anyone interested to check out this thread.

[View the full thread on the MRH website](#)



[REGISTER](#)
(free)

[INDEX](#)

[TABLE OF CONTENTS](#)

Recent weekly photo fun

Some fascinating photos have showed up on the latest *MRH* forum weekly photo fun thread just as we are putting the magazine to bed.

[View the full thread on the *MRH* website](#)



4. MRH forum member [gmpullman](#) (Edmund T.) posted this model photo of a prototype Cleveland Union Terminal P-1a that hauled trains in and out of Cleveland from 1932 through 1953. Nothing like a good electric loco photo!

5. MRH Forum member [CP Rail Quebec Subdivision](#) (Pierre D.) posted this photo of a seldom modeled scene on his layout. Look closely and you will see an active track in the background disappearing into the trees, and in the foreground you will see an abandoned railroad crossing that has been paved over! Pierre has done a superb job in this scene. Modeling abandoned rail lines when done well really create a stand-out layout scene. Well done, Pierre!



[Get more articles like this](#)

GIVE IT A LIKE



BACHMANN®

HO SCALE
HO
SCALE

THE Queen OF STEAM RETURNS

NORFOLK & WESTERN CLASS J IN HO SCALE

Constructed by the Norfolk and Western Railway in Roanoke, Virginia between 1941 and 1950, the Class J was one of the last great streamlined steam locomotives built in the United States. Despite its late-era arrival, Norfolk & Western was a steam holdout, and the Class J enjoyed a longer service life than many of its contemporaries. Sadly, dieselization eventually spelled the end for all but one of the 14-strong class. Number 611 was preserved, and eventually saw steam again not once, but twice, as part of the Norfolk Southern steam program; first in the 1980s - earning the nickname "Queen of Steam," and again in 2015. Today #611 remains operational as part of the Virginia Museum of Transportation collection and returns to excursion service this fall on the Virginia Scenic Railway. Bachmann's HO Scale Class J also returns this fall, now with Soundtraxx® Econami™ Sound Value On Board®. Available numbered as steam-era #613 and as #611 in both its 1980s-era excursion appearance and as it appears today as the "Spirit of Roanoke," the Queen of Steam is back - and she's never looked so good!



NORFOLK & WESTERN #611 - RAILFAN
Item No. 53201



NORFOLK & WESTERN #613
Item No. 53202



NORFOLK & WESTERN #611 - "Spirit of Roanoke"
Item No. 53203



New "Spirit of Roanoke" version

Click to
learn more

Features include:

- DCC Sound Value® Econami™ sound-equipped
- dual-mode NMRA-compliant decoder for DCC and analog operation
- precision motor
- operating headlight and backup light
- highly-detailed appearance with separately-applied parts
- functioning metal side rods
- magnetically operated E-Z Mate® Mark II couplers
- blackened machined metal wheels with RP25 contours

MSRP: \$489.00 EACH • SHIPPING NOW

Bachmann Industries, Inc. • 1400 East Erie Avenue • Philadelphia, PA 19124 USA • www.bachmanntrains.com

Click for more information.



REGISTER
(free)

[INDEX](#)

[TABLE OF CONTENTS](#)

WHAT'S NEAT

column



Model Railroad Hobbyist | November 2023

KEN PATTERSON COVERS THIS MONTH:

- NEW PRODUCTS FROM BROADWAY LIMITED
- PART 4 OF THE HON3 LAYOUT PROJECT
- BACHMANN'S TYLER HANEY SHOWS OFF NEW AND UPCOMING PRODUCTS



click to play video

PHOTOS AND VIDEO OF SUPERB MODELS

THIS MONTH KEN SHOWS OFF AN SD45 AND JOSHUA SHOWS off an operating water tower, both from BLI. The HOn3 layout project comes to a close with a lot of run-by photos and videos. Finally, Bachmann's Tyler Haney shows some of the new products we'll be seeing soon.

New products from BLI



1. Broadway Limited is coming out with an SD45 in HO scale, with Paragon4 sound recorded from an SD45 at the Lake Superior Railroad Museum in Duluth, MN.

Did you see this article?

in the **NOVEMBER 2023 MRH RUNNING EXTRA!**



**Modeling the Royal
Chair Factory**

Get full eBook now ▶

← *click
here*

Each eBook has 80-100 pages

MRH

**RUNNING
EXTRA**



REGISTER
(free)

[INDEX](#)

[TABLE OF CONTENTS](#)



2. Joshua Barton demonstrates the latest release of the Broadway Limited motorized water tower with sound.

Building an HO_n3 layout – building the turntable



3. Ken splices together multiple 50' Micro Engineering Girder Bridge sections to make two 65' turntable bridge sides.



4. After drawing the center and outside circles for the turntable, Ken routs the turntable pit in the foam.



5. Ken then test-fits the turntable bridge into the pit, using a quarter-inch stereo plug as the pivot. The plug also will provide the power connection to the turntable track.



6. Ken assembles the turntable bridge by gluing ties to the top, and then hand-spiking the rails to the ties.



7. Ken draws the shape of his turntable power control panel on a piece of Plexiglas.



8. The assembled and tested turntable section is glued into the layout with spray foam adhesive.



9. After the foam cures, Ken simply cuts away the extra foam and blends in the scenery.



REGISTER
(free)

[INDEX](#)

[TABLE OF CONTENTS](#)



10. The complete layout includes techniques that can be used in any scale.



11. Ken uses reference materials for inspiration and guidance in building the layout. The RGS Story, standing in front of him, is 12 volumes covering every mile of the Rio Grande Southern.

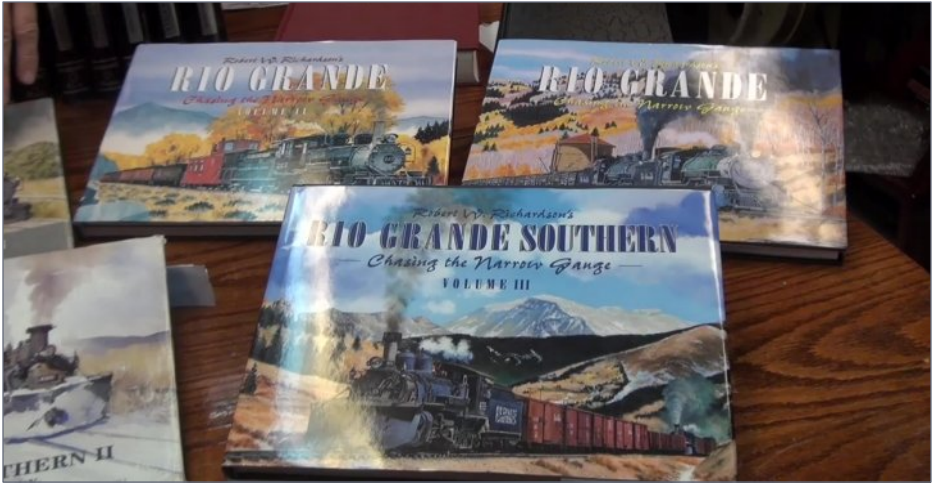

12. Among the other books Ken discusses, Robert W. Richardson has written three volumes on the Colorado narrow gauge railroads, where volumes 1 and 2 cover the Rio Grande, and Volume 3 covers the Rio Grande Southern.

Did you see this article?

in the **NOVEMBER 2023 MRH RUNNING EXTRA!**



**Scratchbuild
common fleet parts**

Get full eBook now ▶

[click here](#)



**RUNNING
EXTRA**

Each eBook has 80-100 pages



REGISTER
(free)

[INDEX](#)

[TABLE OF CONTENTS](#)

Tyler Haney shows off some upcoming products from Bachmann



13. Bachmann's Tyler Haney has samples of upcoming HO scale GE 44-ton locomotive with DCC & Tsunami2 Sound. In this run is Amtrak, Baltimore & Ohio, Santa Fe and Union Pacific, and Tyler is holding #33, a 44-tonner that was used by the

Strausburg Railroad as late as the 1990s.



14. Also in HO scale, Bachmann is releasing the Norfolk & Western J-Class in three paint schemes, the 611 as the Spirit of Roanoke, the 611 in its original paint scheme of the 1950s, and number 613. They will feature SoundTraxx Econami sound.

Get more articles like this

GIVE IT A LIKE





15. In N scale, Bachmann is releasing a new run of the Baltimore & Ohio EM-1 2-8-8-4 locomotives, with two road numbers and SoundTraxx Econami sound.



16. New in N scale is a track-cleaning plug-door boxcar, decorated for Canadian National, with a promotional paint scheme of mastheads of Canadian newspapers on the other side. The car also comes decorated for Great Northern.



REGISTER
(free)

[INDEX](#)

[TABLE OF CONTENTS](#)



17. Christmas is coming, and Bachmann is making some special train sets for Menards this year, including the Eagle Express seen here, with a CSX GP40, three cars, a caboose, and several accessories.

For the complete instructions on constructing the Blackstone layout including several minutes of run-by videos and photos and even more products coming from Bachmann and Menards, see the video in the link at the beginning of this article.

Did you see this article?
in the **NOVEMBER 2023 MRH RUNNING EXTRA!**



Build an animated lift bridge

[Get full eBook now ▶](#) ← *click here*

Each eBook has 80-100 pages



Get more articles like this

GIVE IT A LIKE 

Digit

Introducing the UT6 & for Digitrax Comp



- **Compact size for easy one-hand**
- **Color 1.5" LCD Screen**
- **Full numeric keys for easy Loc**
- **Fine speed control with a large**
- **Removeable LocoNet® cord**
- **Forward/Reverse toggle switc**
- **Off/On switch, uses AA or BP6**

Find out more @ www.digitrax.com



REGISTER
(free)

[INDEX](#)

[TABLE OF CONTENTS](#)



UT6D Utility Throttles Complete Train Control!

Hand operation

UT6

Utility Throttle

\$105.00 MSRP

Automotive selection

UT6D

Duplex Utility Throttle

\$170.00 MSRP

Throttle with Braking

**View all features and *more*
on our website!**

2400MH batteries

digitrax.com/throttles/



Southern Digital

WWW.SODIGI.COM

Celebrating 28 Years serving you

New Items from Digitrax just in time for the Holidays



Evolution Express Duplex Radio
List \$655, Your Price \$524



Zephyr Express
List \$245, Your Price \$196



Evolution Express
List \$470, Your Price \$376



DT602D Radio Throttle
List \$270
Your Price \$216



UT6D Radio Utility Throttle
List \$180
Your Price \$144



DT602 Super Throttle
List \$200
Your Price \$160



UT6 Utility Throttle
List \$115
Your Price \$92



UR93 Duplex Receiver
List \$130
Your Price \$104



BD4N Block Detector
List \$37
Your Price \$29.60



BXPA1 Auto Reverser
List \$49
Your Price \$39



Ni-MH Battery for DT602 or UT6
List \$13
Your Price \$10.40

DCC Conversions, Service & Support

E-mail: sales@sodigi.com (770) 929-1888



REGISTER
(free)

[INDEX](#)

[TABLE OF CONTENTS](#)

Yes, wire size matters

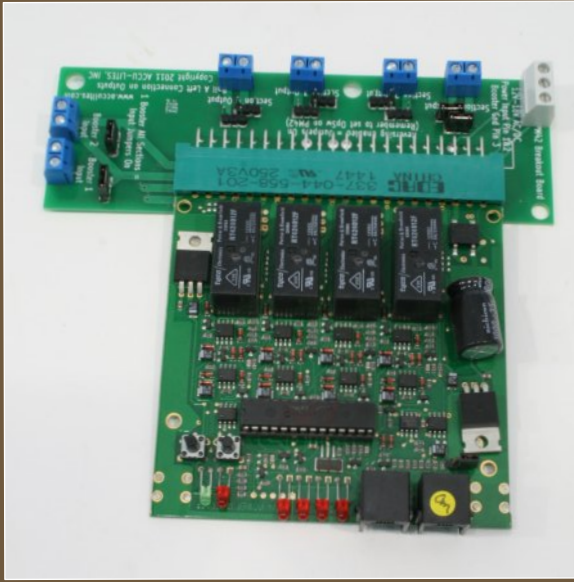

Electrical
Impulses

Model Railroad Hobbyist | November 2023

MARK JUETT REVIEWS THE BEST
WIRE GAUGES FOR LAYOUT WIRING ...



THE GAUGE AND TYPE OF WIRE USED ON A MODEL railroad makes a big difference in performance. The principles discussed in this article apply to both DC and DCC.

In the days before DCC, many wired their pikes with smaller gauge wire because it was cheap and readily available. The current requirement for a single or even a pair of DC locos was not much.

When running at less than half-throttle, the current draw was typically less than an amp per loco (HO scale).

With the introduction of DCC, many owners simply removed the DC power pack, put in the DCC power station, set all the track block switches to the DCC power station, and began ran trains.

Note that when I say “power station” with DCC, I’m referring to the combination of the command station and a power booster.

If the wiring was heavy enough, things worked well. But problems arose if the wiring was too light to carry the increased current of several engines running simultaneously. They might run slower at the farthest point from the power station, or a locomotive might operate erratically.

These problems come from voltage loss over distance from the power station. So why did we see this loss? The two most common reasons are: (1) relying on the rail to carry the electrical power, or (2) using a too-small bus wire to carry the current.

When a voltage is applied to an electrical circuit, current flows through that circuit. The amount of current is proportional to the total resistance of the circuit, including the load (motor, light, etc.) and the connecting wire.

Rail size	Ohms per 100 ft
Code 250	0.42
Code 140	1.71
Code 100	1.74-3.06
Code 80	4.50-11.58
Code 83	3.93-8.31
Code 70	5.09-7.57
Code 55	7.63-15.03

1. Typical nickel silver rail resistance. Compared to copper wire [2], nickel silver rails have a higher resistance and lower conductivity. The rail resistance can vary from one manufacturer to the next because the cross section area can vary (different dies used to extrude the rail). Brass rail has a lower resistance, but nickel silver looks better and has a lower oxidation rate as compared to brass. Also, these resistance values can vary due to different alloy ratios of copper, nickel, and zinc used to make the specific nickel silver rail.



TamValleyDepot.com



Home of the
Frog Juicer

Dual Frog Juicer

Automatic DCC Polarity
Reverser can be used to:

Power Two Frogs

Crossovers

Crossings

Automatic Reverser for

Turntables

Wyes, Loops

Circuit Breaker

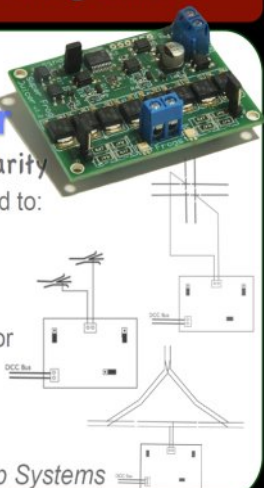

Use with 2-10 Amp Systems

**DON'T BE A
TURKEY,
GOBBLE UP A
PROTOHROTLE
THIS HOLIDAY
SEASON!**



**TASTY
THROTLE!**

ADVERTISEMENT

Make LocoNet wiring extremely simple!

ACCU-LITES, inc

Your DCC Center!



PM42
breakout
board



SE8C
breakout
board



BDL168
Multi-zone
breakout board



BDL168
Single-zone
breakout board



Now Offering SNAPS! in packs of 6 or 12 pieces! [CLICK TO LEARN MORE ...](#)

Dependable **Wireless** Radio Control!



*... and **so** much more!*

GET THE DETAILS ►

click here

RE RINGTM
ENGINEERING



REGISTER
(free)

[INDEX](#)

[TABLE OF CONTENTS](#)

DETERMINING BUS WIRE SIZE WITH OHMS LAW

Ohm's Law describes this: $V = I * R$ means that the voltage **V** is proportional to the current **I** and the resistance **R**.

If the resistance of the wire is zero, no voltage appears across that wire ($V = I * 0 = 0$), and the full supply voltage is available to the load. But as wire resistance increases, voltage across that wire also increases, which reduces voltage at the load.

But wire resistance causes the voltage to be split between the load and the wire.

Plan to use wires that doesn't drop voltage more than 5% under maximum current draw. For a typical HO power station set to 14V, the voltage should not drop below 13.3V. Refer to NMRA S-9.1 Table 2.3 for minimum / maximum voltages for power stations and decoders (www.nmra.org/sites/default/files/standards/sandrp/pdf/s-9.1_electrical_standards_for_digital_command_control_2021.pdf).

See [2] for the resistance of copper wire for various gauges.

Use Ohm's Law to select a suitable wire size for your power bus. You will need to know the total current (amps) expected on each two-wire bus, and the amount of voltage drop you will tolerate at the end. Let's say it's acceptable for the bus voltage to drop 0.7 volts at the farthest point while drawing 4.5 amps (14V drops to 13.3V – the same 5% mentioned above).

Ohm's law for resistance is $R = V / I$ (resistance in ohms = voltage drop divided by current in amps).

Thus, $R = 0.7V / 4.5 = 0.156$ ohms.

This means the total wire in your power bus (out from the power station, and back again) should have a resistance of no more than 0.156 ohms. Referring to [3], we see that 100 feet of 12 AWG wire has a resistance of 0.1588 ohms – close enough.

So if you use 12 AWG wire for your power bus, 50 feet from the power station to the end, and 50 feet back again (100 feet total), the voltage drop at the end will be $V = I * R$ or 0.715 volts.

Another example: Instead of a maximum current of 4.5 amps, you expect half that, or 2.25 amps. Now the resistance to drop 0.7V becomes $R = 0.7V / 2.25 = 0.311$ ohms. This falls between 14 AWG and 16 AWG in table [2]. Use the larger 14 AWG wire.

CHOOSING BUS WIRE SIZE WITH CHARTS

On the following pages, I present several charts [2.1 - 2.4] to help you quickly size the bus wire based on distance of the run from the power station. The calculations take into account the total wire run both out and back.

On the bottom axis look up the length of run. Then draw a vertical line up to the size of wire planned. Lastly, draw a horizontal line to the left to find the voltage loss. If this exceeds the recommended 5% loss limit (for example, 0.7 volts with 14 volts out at the booster), select the next larger wire size and check again.

In selecting the chart for amperage, it should be equal to or greater than the amperage capacity of your power station. Under most conditions the current draw will be much less, but in the event of a short circuit the full capacity of the power station will be present.

It is good design to size the wire to the maximum current capacity of the power station even though in most situations the current draw will be much less. If the wire size is too small and the resistance too great, this can make the short protection circuit breaker of the power station (or any other circuit breaker) not trip.

If the circuit breaker fails to trip, you could burn up or weld a truck and/or set of wheels causing the short circuit. In extreme cases this has destroyed trucks, wheels, and even damaged track.

A good method to check that the circuit breaker in the power station or external circuit breaker, is working properly is to place a





Holiday SPECIALS

Visit www.soundtraxx.com/bf
for more details on our holiday promotions.

SOUNDTRAXX
Durango, Colorado USA

ADVERTISEMENT

**Still running DC because DCC not
worth the time / money / effort?**

Discover **LocoFi™**

True multi-loco, multi-engineer control

LocoFi™ Exclusive:

- ✓ Prototypical Ops with SPEED PROFILES
- ✓ Multiple Speed Profiles 
- ✓ Super Fine SPEED CONTROL 
- ✓ Accurate SCALE SPEED 
- ✓ Auto Speed Match for EASY CONSIST
- ✓ Auto Chuff Sync for STEAM **NEW**
- ✓ Emergency Stop (PRESSURE SENSITIVE)
- ✓ Auto Stop NO MORE 'RUNAWAY TRAINS'

... THE LIST GOES ON!!!

Learn more ▶
wifimodelrailroad.com



Power it your way | Wireless control | User customizable
DC, DCC, AC or | using Smartphone | On-board Sound
Battery **LocoFi™** customers never look back ...

When talking
to hobby
vendors,
please
remember to
mention MRH.

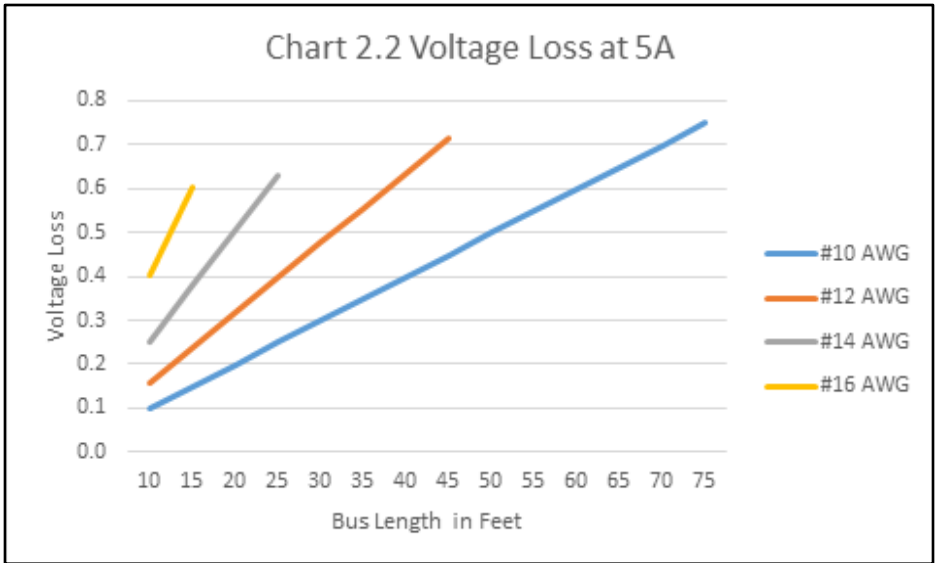

2.1, 2.2, 2.3, 2.4. Use these charts to quickly determine the proper bus wire size to get a minimal amount of voltage loss. See the text for details.

Chart 2.3 Voltage Loss at 7A

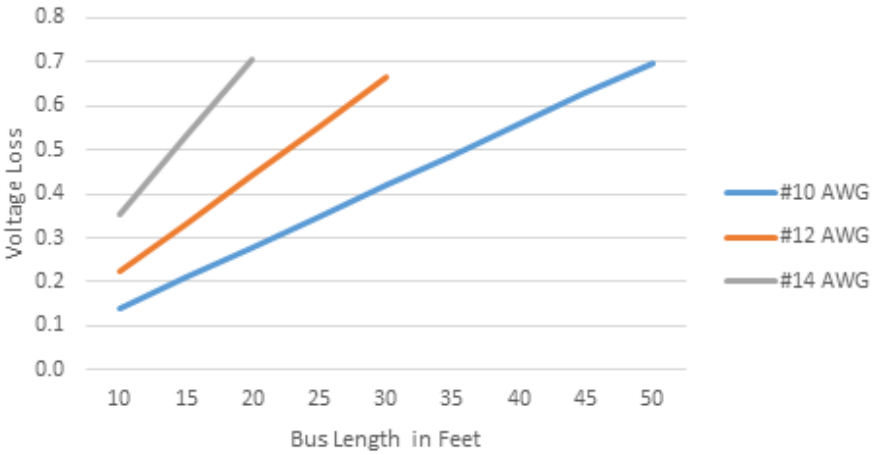
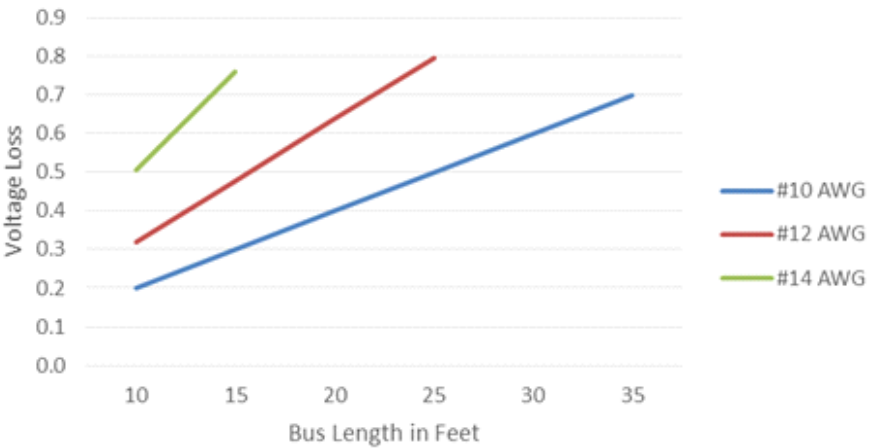

Chart 2.4 Voltage Loss at 10A



Get more articles like this

GIVE IT A LIKE





S T A T I O N

We carry your favorite DCC products!

NCE | Digitrax | Speakers | RailPro

SoundTraxx | Train Control Systems

ESU LokSound | Tam Valley Depot

www.LitchfieldStation.com

sales@litchfieldstation.com

623-298-7355



REGISTER
(free)

[INDEX](#)

[TABLE OF CONTENTS](#)



M. Juett

SOLID VS. STRANDED

Bus wires and the feeders may be solid or stranded. Stranded wire is more flexible and less prone to breaking with repeated bending, but sometimes the ends splay and are more difficult to fit into terminals.

Many prefer solid wire for the feeder drops. The late Andy Sperandeo used solid wire, flattened the end, and bent it at a right-angle like a spike. He drilled a hole in the wood tie and soldered the end of the wire to the base of the rail so that it looked much like a spike. That was going the extra mile.

metal object across the rails at multiple points away from the power station or breaker to verify that the breaker trips.

This is commonly referred to as the quarter test, where you place quarter across the rails to deliberately create a short. In larger scales, a larger coin or other large metal object would be required to reach across both rails.

Selecting the proper wire size to be used depends on length of run and the current capacity of the DCC power station. It is not a matter of deciding a certain wire size worked for my friend so that is what I will use. Check the charts!

Some portions of your railroad may need one size and other parts a different size. However, using the larger wire on *all* of the railroad doesn't hurt anything, although it can be more expensive. On the other hand, it may be less expensive to buy one larger roll of the larger wire than to buy a second roll of smaller wire.

There are some terminal connections in circuit breakers and power stations where larger wire does not fit, especially if it is stranded wire. You may use a smaller wire for short distances because the voltage drop over short runs will be minimal.

To deal with the smaller terminals make a secure connection to the heavier bus wire and run the short *flexible wire* and connect to the terminal (note that I said flexible wire). A stiff / heavy wire can put excessive strain on the terminal.

Using a smaller stranded wire can reduce the stress and potential for damage. This also applies to the internal wiring of some current sensing detector circuits. However, it's best to use the largest wire that will fit in the terminals.

RAIL, FEEDERS AND RAIL JOINERS

Brass rail used to be popular in the early days of the hobby, but today we use nickel silver rail because it looks more like steel rail and is slower to oxidize, but it's not a great conductor.

While it's called nickel silver, in fact, it's an alloy without silver. The most common composition of nickel silver rail is 18 percent nickel, 62 percent copper, and 20 percent zinc.

Gauge	Ohms per 100 feet	Diameter inches
#10 AWG	0.0999	0.1019
#12 AWG	0.1588	0.0808
#14 AWG	0.2525	0.064
#16 AWG	0.4016	0.0508
#18 AWG	0.6385	0.0403
#20 AWG	1.015	0.032
#22 AWG	1.614	0.0254
#24 AWG	2.567	0.0201

3. Resistance of copper wire by gauge.

EAST TRACKS

Build your own trackwork easily, quickly, and affordably.

TRACK BUILDING SYSTEM

Tim Warris developed the Fast Tracks system in 2003 out of his garage while building his Port Kelsey Railway in HO scale. Striving for a better way to handlay accurate track, he developed a fixture to aid in building trackwork faster and easier.

CELEBRATING
20
 SINCE 2003
 YEARS



Those first fixtures have since grown to a library of over 5,000 unique products that are focused on helping modelers build better trackwork and layouts around the world.



• Easy ordering •

shop online 24/7 • handlaidtrack.com

1-888-252-3895

service@fast-tracks.net

STREAMLINED BACKSHOP

ALL NEW WEBSITE!

SBS4DCC.COM



STREAMLINED BACKSHOP

HOME SHOP BY DECODER INTERFACE PRODUCTS & SERVICES DCC TIPS MORE INFO SITE FEEDBACK BLOG DELAYED SHIPPING NOTICE

DELAYED SHIPPING NOTICE

WELCOME TO THE NEW Streamlined Backshop... Your Virtual DCC Superstore!

Home of the Original "Sugar Cube" Speaker
Order That sounds 1000 sweet...
[SHOP NOW](#)

5 Sizes ... 18 Baffles
90 Sweet Speaker Options

Streamlined Backshop
Sales... Service... Solutions...

SHOP BY CATEGORY

- New Products
- OyGIG Devices
- SBS4DCC Products
- Auto Receivers & Power Management
- Block Detection & Signaling
- Command Stations, Boosters, Thrusters, Accessories
- Mobile Decoders
- Stationary Accessory & Switch Decoders
- Parts & Supplies
- Large Scale (O & D) Products
- The Shelf to The Corner
- Bulk Order
- Shop By Decoder Interface

SHOP BY MANUFACTURER

- DCC Specialties
- Digitalis

CHECK IT OUT ►

Great control in a tiny package



**Original
Touch Toggles**

- Touch Toggle™ plug in controls
- Bright clear indication
- Easy setup
- Flexible system

Stall Motors, Twin-coils,
Power, and Servos

Now for Tam Valley Depot
and MRservo too!

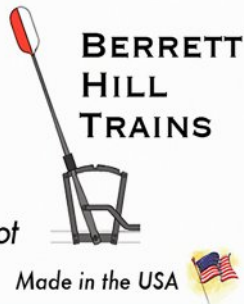

What will they think of next?

www.berrethillshop.com



REGISTER
(free)

[INDEX](#)

[TABLE OF CONTENTS](#)

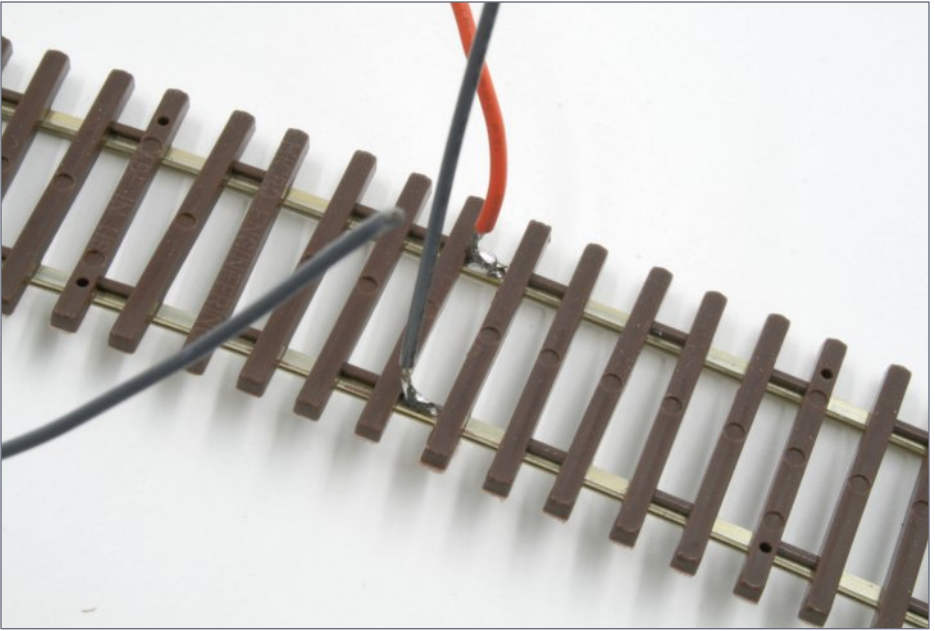

4. Long ago I decided to solder the feeders to the bottom of the rail, which makes the feeders disappear. This can be done even on plastic flex track with good soldering equipment and skill.

Max current	Feeder drop wire size
3A	22 AWG
5A	20 AWG
7A	18 AWG
10A	16 AWG

5. Typical Feeder wire gauge for a section of track. This assumes max current on this section of bus. This may be the current rating of the power station. If external protection is used, the current in this table is the trip current of the protective device for this section of bus.

Take a look at [1] where I measure the resistance of various rail sizes. As you can see, the resistance can become quite with smaller rail, especially if the distance between feeders is very long.

Then if you add in less than perfect rail joiner connections from unsoldered rail joiners, plus any oxidation and/or glue residue from attaching ballast and scenery materials – and the resistance can become huge – sometimes approaching infinity.

Since rail has much more resistance than copper wire, plan to attach a feeder drop for every 3 feet of rail. For shorter lengths, solder a feeder wire to each length of rail that is not soldered to an adjacent rail with a feeder.



M. Juett

EXPANSION JOINTS

Assuming average temperature and humidity, rail expansion gaps should be about the thickness of a business card or the NMRA standards gauge (about 0.020”).

Expect your benchwork to expand and contract with changes in humidity, and gap your rails accordingly. If laying track in winter, the relative humidity tends to be low, and the wood at maximum contraction. The rail gaps should be less to allow for benchwork expansion.

If laying in the summer, when humidity tends to be high, then the benchwork wood is at maximum expansion. Increase the rail gaps accordingly to allow for benchwork contraction.

Plywood benchwork eliminates some of this because of its layered construction with wood grain oriented in several directions. Even plywood, however, is subject to some degree of expansion and contraction.



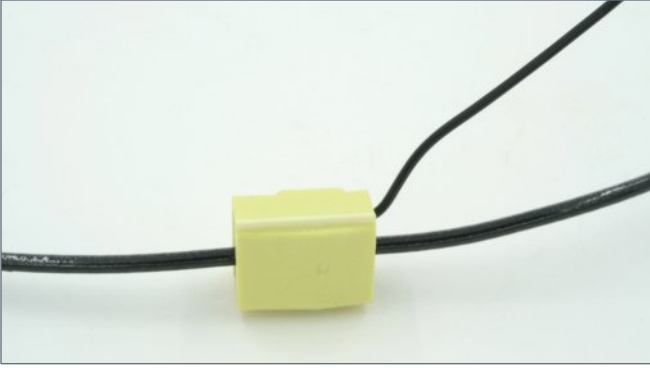

6. Insulation Displacement Connectors (suitcase connectors) should be the right size for the wire.

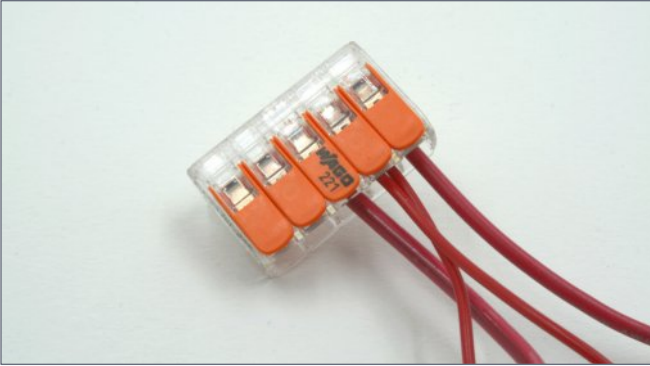

7. Wago brand connectors.



8. A soldered feeder connection.

A short section of rail (under 6") can be connected to a longer section with a soldered rail joiner, but leave some rail joiners unsoldered to allow for benchwork expansion and contraction (see sidebar).

Expansion joints work well on straightaways, though it is often preferable to solder the rail joiners in curves to keep them smooth.

Solder your feeders on the bottom or the outside of the rail; avoid soldering inside the rails, as this could cause a derailment.

If you are careful and neat with your work, after painting and ballasting the rail, they are hardly noticeable [4].

Refer to [5] for feeder wire size recommendations based on expected current draw in that section of track.

Feeder drops must have a solid connection to the bus, but how you attach them is a matter of preference. Many prefer the ease of using insulation displacement connectors (IDCs) [6]. Others use wire nuts or Wago brand lever type connectors [7].

Yet others of us prefer the security of stripping and wrapping the feeder around the bus wire, then soldering it [8]. I have seen failed connections with all these methods, so test to make sure that your connections are solid.

You can run parallel bus wires or loosely twist them together.

OVERLOAD PROTECTION

Some have suggested using automotive tail light bulbs in series with the bus wire for circuit overload protection. This arrangement will limit the current, but the bulb is slow to react.

Electronic circuit breakers [9, 10] are more expensive, but the reaction time is quick. Many electronic circuit breakers are adjustable for reaction time and trip current.



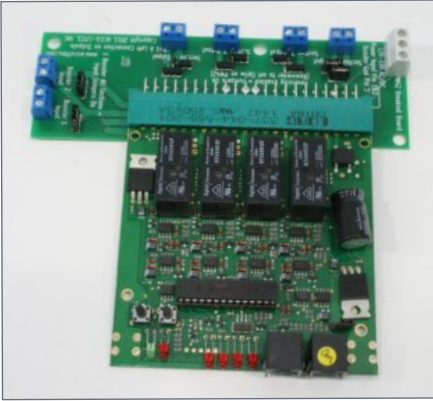

9. Digitrax PM42 circuit breaker.

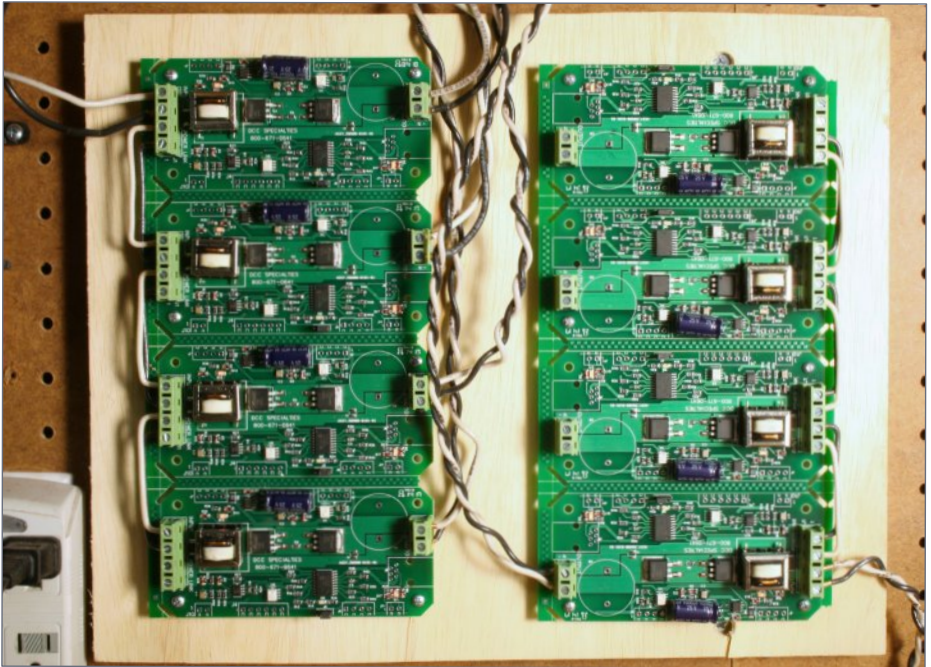

10. Two Power Shield PSX4 circuit breakers.

Get more articles like this

GIVE IT A LIKE



If you have areas where only one or two locos will work at a time, you can set the trip current to a lower value. It is worth paying more for an electronic circuit breaker.

You can divide a large model railroad into power districts with a circuit breaker protecting each one. If there is a short in one section the other sections continue to operate without interruption.

Much of this information above and a lot more is available at: nmra.org/sites/default/files/standards/sandrp/pdf/technotes/tn-9.pdf on the NMRA website under Standards at TN-9.

I was the primary author of this Tech Note with help from Ken West, Brian Barnt, Karl Kobel, Stuart Baker, Jim Scorce, Dick Bronson, Reinhard Müller, and several others.

The NMRA.ORG site contains a lot of useful information that is updated frequently. You should check and see what is there.

MARK JUETT



Mark Juett has been interested in trains since an early age. His older cousin Jimmy was a huge influence in that. Mark models the Louisville, Cincinnati & Lexington sub of the Louisville & Nashville RR in September 1967 and holds regular monthly op sessions.

Mark serves in the NMRA Standards & Conformance Department as Deputy Manager. He also writes the monthly Pulse of DCC column for the NMRA Magazine.

As time permits, Mark does custom model railroad work for others. ■





The drought is over!



All major
LokSound Decoders
back in stock!

LOK  **SOUND**
EST. 1999

www.loksound.com

From first train set to railroad empire...

*Our complete line of DCC products
grows with you. Discover the fun!*

- Designed and manufactured in the U.S.A.
- Preferred for ease of use and ergonomic design
- Unlimited scalability for any size model railroad
- Plug-and-play means more time running trains
- Great customer service and excellent support



See your dealer



REGISTER
(free)

[INDEX](#)

[TABLE OF CONTENTS](#)



Visit our new and improved web site for all your DCC needs!

- Get the latest new product announcements
- Watch our detailed how-to videos
- Browse the all-new Information Station
- Enjoy secure online sales, day or night!

Visit **ncedcc.com**



MRH MARKETPLACE



**Professional Layout Design
And Construction Services**



**Click The Ad To Visit
Our Website**

AffordableModelRailroads.com

Email At

AffordableModelRailroads@gmail.com

or Call 800-216-9202

WE'RE BEHIND YOU ALL THE WAY

Sceniking[®].com

...nothing compares...

Click to learn why!

MONASHEE

CLICK HERE

LASER

ENGINEERING

**MANUFACTURING RAILROAD
STRUCTURES. FALL SALE. STOCK MODEL KITS**

MEGA SALE

**BLACK
FRIDAY**

**FREE
SHIPPING**

FOR ORDERS OVER \$60 US

miniprints.com

THE N-SCALE DIVISION Since 1992

Top Quality **N-SCALE** Discount Prices

American - European - Japanese - DCC/Sound

KATO
PRECISION RAILROAD MODELS

**MICRO-
TRAINS-
LINE**

Fleischmann

TRIX

SOUNDTRAXX

ESU



ATLAS FREIGHT CAR CLOSEOUTS!

**DOZENS OF MODELS NOW AT 30% OFF MSRP
GET THESE BARGAINS BEFORE THEY'RE GONE**

nscaldivision.com



REGISTER
(free)

[INDEX](#)

[TABLE OF CONTENTS](#)

LOOK
at what's new at
Black Cat this month

Click here for
our website

CPR 36' Box car
Murphy steel ends 6' door
3D printed by twenty models



Black Cat Publishing
(204)489-5005
ajfergus@mymts.net
blackcatdecals.com

PRE-SIZE
MODEL SPECIALTIES

P.O. Box 6 Paonia, CO 81428
Ph. 970 527 4586
Made in The USA

Cast resin items for All Scales.
Tunnel portals, bridge piers, abutments,
culverts, and retaining walls.
Trackside details and sage brush tree
armatures.

"FREE SHIPPING see website for details"

Hobby Marketplace
Ads are Economical
and Effective.

Click to learn more ...

click to learn more!

East Coast Circuits
Innovating Your Model Railroad Layout



P.O. Box 25412
Providence, RI 02905

Lighting Circuits For Your Layout

Random Lighting Circuit - Burning Fire Circuit
Traffic Light Circuit - Crossing Signal Circuit

Custom Lighted Vehicles
HO & O Scale Emergency Vehicles
HO & O Scale Trucks & Cars

Eastcoastcircuits.com Eastcoastcircuits@gmail.com

WEATHERING
POWDER



MONROE
MODELS

www.monroemodels.us

PORK STORE



Kit HO-3104

www.interactionhobbies.com

Light EFX-16



Coming soon!

- On-lay-out lighting effects for 16 Just Plug® - compatible outputs; programmable via DCC or LCC
- >30 light effects such as blinking, pulsing, "fire", fluorescent tube, traffic signals, photographer, welder and more!
- Programmable brightness
- Trigger via on/off switch, DCC switch command, or LCC fast clock time

LOGIC RAIL™
TECHNOLOGIES

(281) 251-5813

info@logicrailtech.com www.logicrailtech.com



PRECISION DESIGN CO.

CUSTOM DECALS FROM
YOUR OWN ART IN JUST ONE DAY

PDC.CA

FULL COLOR & SOLID WHITE



Squeaky's Trains

10% Off Sitewide! Use Coupon Code MRH2023 at Check Out!
(Certain items & S/H excluded)

SqueakysTrains.com



Offering:
Walthers, SoundTraxx, NixTrainz, RailPro, Woodland Scenics, Bar Mills, and many more Railroading Supplies!

Let's play with trains!



Roomettes

Bring Your Structures to Light

REAL TRACK SCALED DOWN!

Home of the only prototypically accurate Turnout Kits, Fixtures and Track Parts for HO and Proto:87.

Scale Spikes, Tie Plates, Real Wood Ties and Bulk Rail in codes 83, 70 ,55 and 40

PROTO87.COM

Model Railroad Control Systems

- Geoff Bunza Project Boards
- DCC Occupancy Detectors
- CMRInet Compatible Nodes
- Layout Telephone Systems
- RFID Switchlist Generator
- Switch Machines and Drivers



[Click Here](#)

Great Decals!™

FEC, Interstate, Virginian Railway, & L&N Titles
After Hours Graphics Line
Coupler Gages and More
In O, S, HO, and N Scales



WESTERFIELD

GOLDEN AGE LINE
MODELS, LLC

NEW KIT: 11001 N&W BATTLESHIP GON



ALSO X23/R7 LADDERS
westerfieldmodels.com

Your ad could be in this space for just \$88 a month.

[Click to learn more ...](#)

ITLA Scale Models Inc.

Laser Cut Wood Kits- N / HO / O



Industrial Architecture

CLICK FOR MORE DETAILS ...

www.itlascalemodels.com

CROW RIVER PRODUCTS



"O" SCALE KIT 337

STEAM POWERED THREE DRUM WINCH

Provides Three Lines For Clam Shell Buckets Etc.

On Board Two Cylinder Steam Engine.

This Winch will be included in our upcoming Dredge Kit

"O" Scale Kit 338 Due out this Fall

Price 70.00

Made in USA

HO & O Scale Machinery, Derricks,
Engines, Hardware & Waterfront Models
Pawtucket, RI 02861 Tel 401-723-0065
www.crowriverproducts.com

Please tell your buddies about MRH!

WE RELY ON WORD-OF-MOUTH TO GROW AND A BIGGER CIRCULATION MEANS MRH IS MORE LIKELY TO STICK AROUND FOR A LONG TIME TO COME!

A guide to diesel locomotive trucks

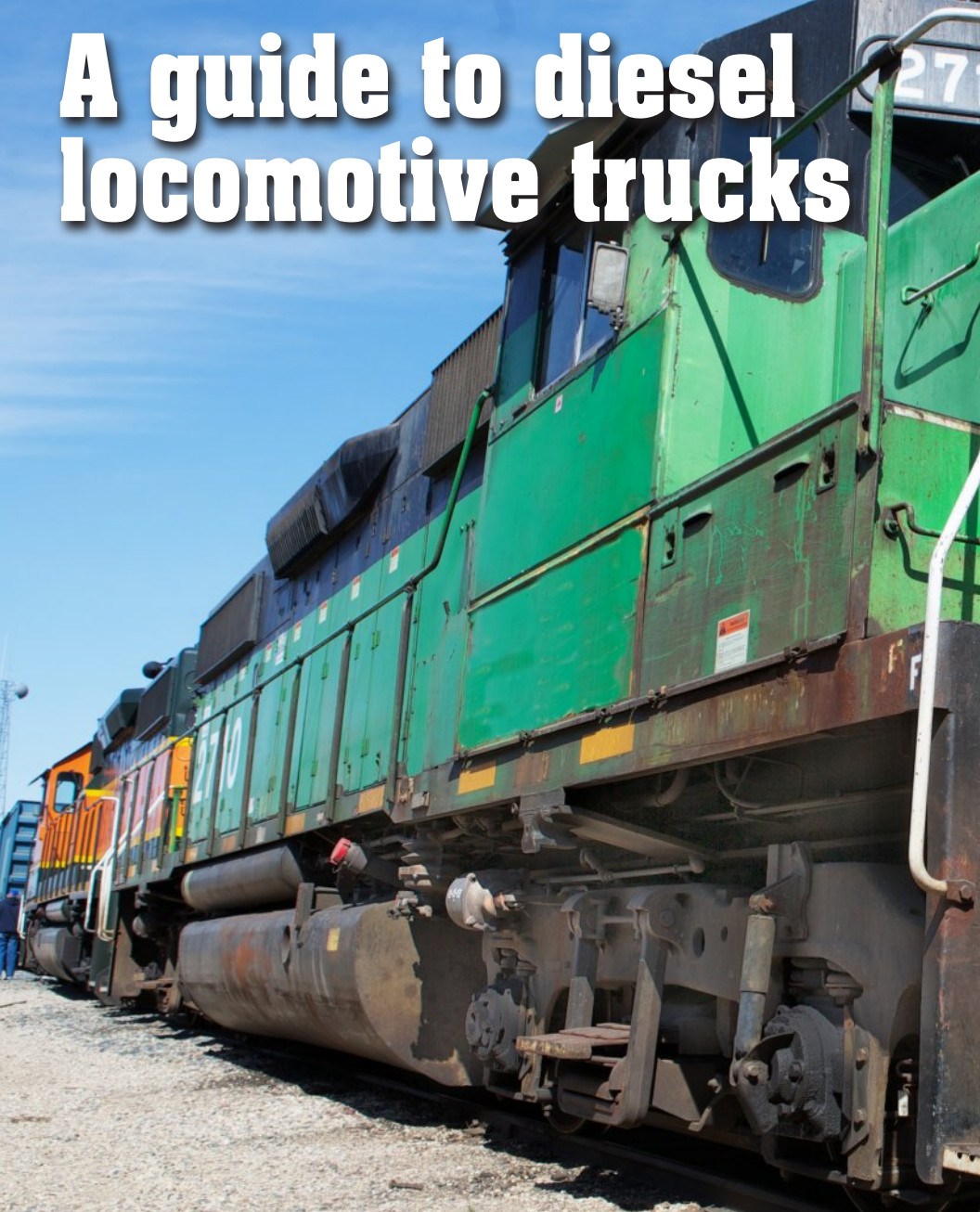

RICHARD BALE REVIEWS TRUCKS FOUND ON
DIESEL LOCOMOTIVES...



REGISTER
(free)

[INDEX](#)

[TABLE OF CONTENTS](#)



Get the bonus download:
Table of all diesel locos and
what trucks they came with



PRIOR TO THE MID-1930s, experimental work began to develop rail cars and light locomotives powered by internal combustion engines driving an electric generator. They utilized trucks designed for trolleys and electric locomotives.

In 1924 a consortium of Alco, General Electric, and Ingersoll-Rand built the first standardized line of diesel-electric switch engines. The little switcher used a simple truck based on trolley technology of the period [4].

One of the first traction trucks that evolved into practical use on diesel-electric locomotives was a basic two-axle, two-motor truck developed by General Steel Casting in the 1920s. It got beefier over the years, but the basic plain-Jane design remained unchanged. Although never officially approved by AAR, the GSC Type A truck [1] is also known as an AAR Type A Truck.

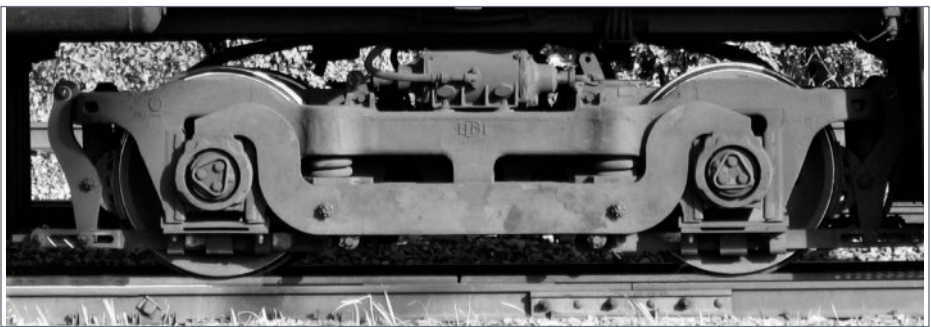

1. This GSC Type A two-axle, two-motor truck was developed in the 1920s for electric locomotives. Spotting features include a pair of bulges that surround coil springs for the double dropped equalizers.



It was not until the mid-1930s, when EMC, predecessor to EMD, began work on its E series passenger locomotive, that an entirely new truck designed specifically for a diesel-electric locomotive appeared [19].

Over the years, the Type A truck was built with both plain and roller journal bearings. The original design had 40" wheels on an 8'-wheelbase. Some later versions were extended to 9'-4".

Among the early application of this truck on diesel locomotives was in 1936 on EMC's SC, SW, NC and NW light switch engines. Additional applications included Baldwin's VO and DS-series of switchers built from 1939 thru 1948.

In the 1940s and 50s Alco and EMC/EMD used the Type A truck on various industrial switchers. Fairbanks-Morse used this truck on its H-10 and H-12 light switchers built between 1944 and 1961. Montreal Locomotive Works used this truck on many of its S-series of yard and light switch engines.

After GSC's patents expired, Adirondack Iron & Steel Co. began supplying both raw castings and assembled versions of the Type A truck.

GSC introduced its Type B (aka AAR Type B) truck in 1941. It featured paired equalizer coil springs, swing motion, and triple-section elliptical bolster springs. EMC used an early version of this truck on its 1200hp Model TA cab unit built for Rock Island's Rocket in 1937 [2].

Alco used the GSC Type B truck on its FA cab units, B-B Century series locomotives, and RS and RSD-1 B-B road switchers. It proved to be a fundamentally sound design that was used into the early 1960s. A version of this truck with 42" wheels on a 9'-10" wheelbase was used on Baldwin's RF-16 Sharknose cab units introduced in 1950.

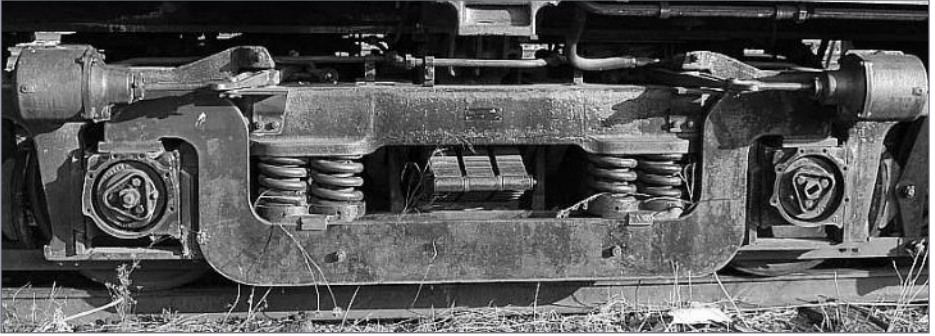

2. GSC introduced its Type B (aka AAR Type B) truck in 1941.



3. This three-axle two-motor A1A truck had a wheelbase of 15'-8". In addition to its extended length, spotting features include goose-neck dropped equalizers with paired coil springs, and two-section elliptical bolster springs. Fairbanks-Morse used it to its Erie-built cab units in 1945. The truck made a more visible debut the following year when it appeared under Alco's highly publicized PA/PB passenger units. Variations over the years included wheel bases ranging from 7'-3" to 9'-4".

Did you see this article?

in the **NOVEMBER 2023 MRH RUNNING EXTRA!**

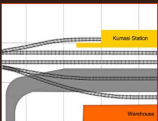

Growing an African
Mushroom layout

Get full eBook now ▶

← click
here



Each eBook has 80-100 pages

RUNNING
EXTRA



REGISTER
(free)

[INDEX](#)

[TABLE OF CONTENTS](#)



R. Bale

TRUCK MANUFACTURERS

The principal suppliers of castings for railroad trucks include General Steel Casting Corporation (GSC) established in 1928, it changed its name to General Steel Industries (GSI) in 1961; Adirondack Iron & Steel Co. (acquired by Rockwell in 1987), the Dominion Foundry & Steel Company, Hamilton, ON (Dofasco), now known as ArcelorMittal Dofasco, and Locomotive Finished Material Co. (LFM) of Atchison, Kansas. Identifying some trucks can be challenging since cast frames supplied by more than one foundry did not always look alike. For example see [29, 32 and 33]. Some locomotive builders had the ability to fabricate their own trucks by welding the frames from steel stock [26, 27, and 35].

ALCO LOCOMOTIVE TRUCKS

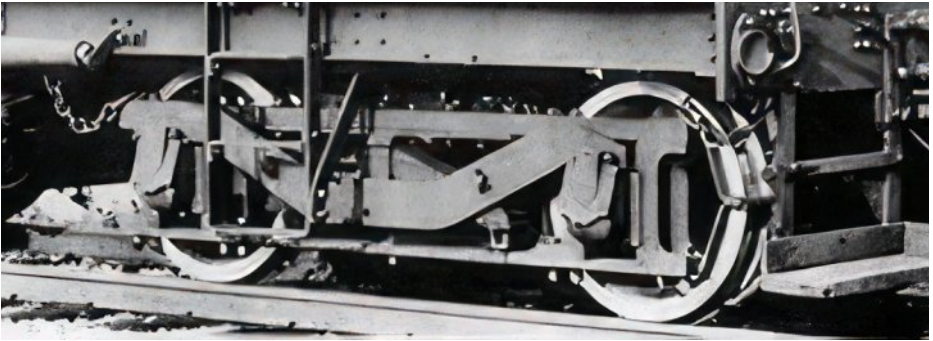

4. In 1924 Alco, General Electric, and Ingersoll-Rand combined their specialized capabilities to produce the first standardized line of diesel yard switchers. Over the next four years a total of 19 units were delivered with this fabricated truck having an outside equalizer.

Get more articles like this

GIVE IT A LIKE



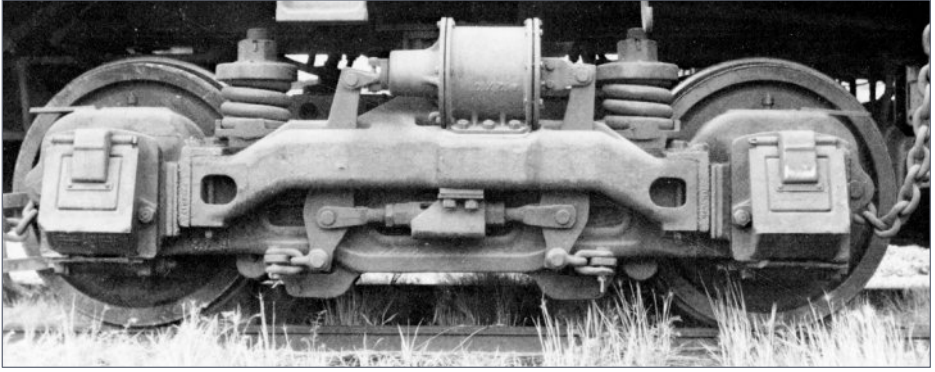

5. Alco used this Blunt B-B truck on several early engines including a 60-tonner in 1931 and the S-2 and S-3 switchers introduced in 1940. The Blunt truck was an in-house design that had a reputation of performing well on rough track. It utilized 40" wheels on an 8' wheelbase. Note the beefy coil springs extending above the inside equalizers.

WHEEL SLIPPAGE

A critical factor in truck performance is wheel-to-rail adhesion. During periods of acceleration, high-horsepower locomotives suffer from wheel slippage. The torque generated by the axle-mounted motors tends to tip the truck, with the leading axle rising and the trailing axle digging in – the same as an automobile does when you stomp on the gas pedal.

The tipping action puts less weight on the truck's leading wheels, which causes them to slip. Eliminating, or at least significantly reducing, wheel slippage involved, developing a way to spread weight on the entire truck rather than just through the center pin.

Addressing wheel slippage became a major issue that locomotive builders and operators could not ignore. Alco's answer to the problem came in 1947 with the introduction of a three-



motor high-adhesion truck [9]. EMD introduced its HT-B high-adhesion truck [17] and wheel-slip detection system in 1977. GE spread the weight on trucks with its Floating Bolster system [29] available in 1969.

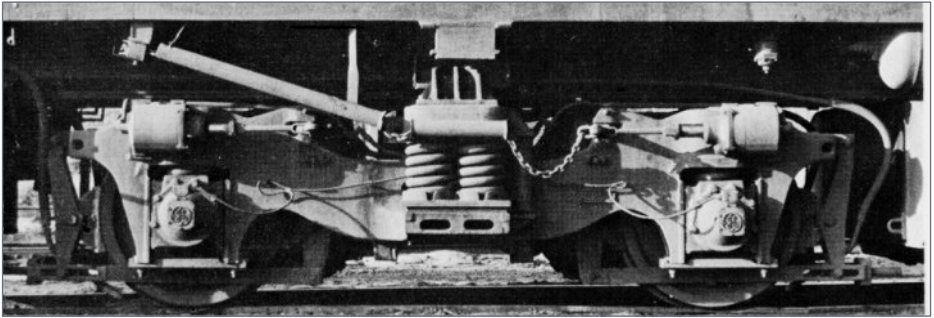

6. In late 1965, Alco offered this high-adhesion two-axle truck on its Century series C415 center-cab heavy switcher. It was also used as an extra-fare option on Alco's high horsepower C430 road switchers introduced in 1966. Note the chain and chain-tubes for the hand-operated parking brake.

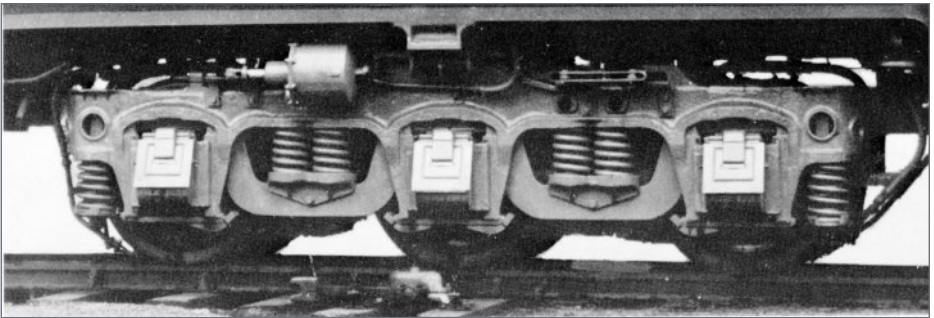

7. Alco used this A1A freight truck on its early DL-109 cab unit introduced in 1941. Note the plain bearing journals, inside drop equalizers, and secondary equalizer springs at both ends of the frame. This truck was also used on Alco's RSC-2 and -3 road switchers.

EQUALIZERS

Equalizers are steel levers that link axles together so that a jolt received by one wheelset is distributed to and partially absorbed by the other. Equalizers were standard on passenger trucks prior to the development of diesel locomotive.

Three forms of equalizers are used in powered trucks. A common design for two-axle trucks is a double drop equalizer with one inside the frame and one outside. The outside member can be seen resting on the top of the journal box [1 and 11].

Trucks with single inside drop equalizers are relatively easy to spot [7, 25]. Drop or bottom equalizers on three-axle trucks usually consist of a pair of dog-leg members looped between the journals on each axle [3]. Straight equalizers are mounted internally and for modeling purposes are generally not visible [12].

As locomotives grew heavier, three-axle trucks were needed to help spread the weight on the rails. Among the earliest was an AAR approved A1A truck [3] with a wheelbase of 15' -2". It had a traction motor on the outer axles with the middle axle functioning as a weight-sharing idler.

As the diesel industry proliferated, so did the variety of trucks. There was some commonality, but locomotive builders tended to favor particular truck designs. Distinctive proprietary models that are easily identified include Alco's two-axle Blunt truck [5], Baldwin's two-axle Batz truck [10], and EMD's two-axle Blomberg truck [14].

FLOATING BOLSTER

The three original trucks with floating bolsters – EMD's Flexicoil, Alco's Hi-Ad and GE's FB series – all functioned generally the same. EMD's Flexicoil [20A] has a coil secondary suspension



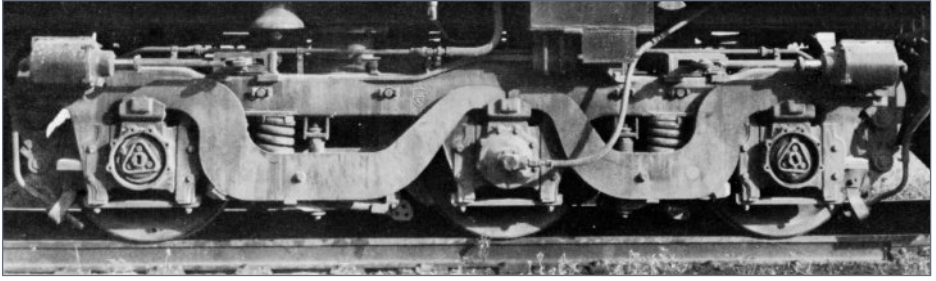

8. Alcos initial use of this three-motor truck with a 12'-6" wheelbase and unequal axle spacing was on its RSD-4 and RSD-5 road switches demonstrated in 1951-52. Five years later Alco used this truck on its RSD-12 and -15 road switchers as well as on its high horsepower C-628 and C-630 locomotives. GE used a nearly identical looking truck on its U25C, U28C and U50C road switchers. In addition to the staggered axles, spotting features include massive double dropped gooseneck equalizers. MLW used a two-motor version of this truck on its RSC-13 road switcher introduced in 1955.

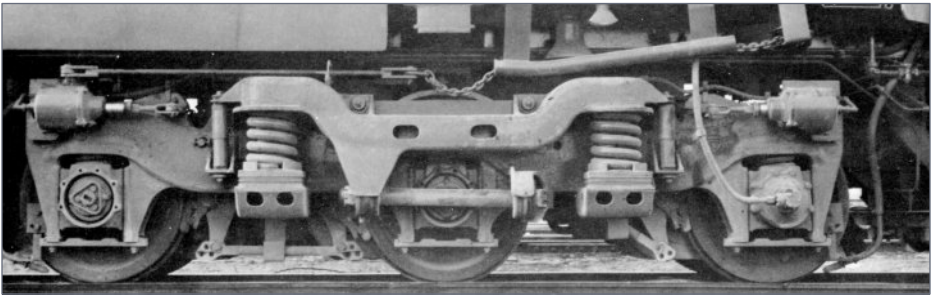

9. High horsepower locomotives suffered from wheel slippage, especially during periods of acceleration. Alco's answer to the problem came in 1947 with the introduction of this three-motor high-adhesion truck with a wheelbase of 13' -7". Of note is the uniquely shaped equalizer with the supporting coil springs located outside the truck frame. The equalizer has automotive-type shock absorbers at each end and a descending leg on the left that is tied to the truck frame by an anchor bolster. Alco locomotives with this Hi-Ad truck included the Century series C-636. This truck was available as an option on Alco's 3000hp C-630 road switcher.

between the truck frame and the bolster. Alco's three axle Hi-Ad truck is functionally like the EMD Flexicoil except the coil springs are mounted outside the truck frame.

In addition to conventional springs, GE's FB-3 floating bolster truck [32] utilized a secondary suspension system consisting of four stacks of rubber pads connected directly between the trucks and the locomotive under frame. Dofasco worked with GE in developing the truck. The truck was introduced in 1966 on the 3300hp U33C road switcher.

BOLSTER ANCHOR

The bolster anchor, also known as a floating bolster, horizontal stabilizer or drag link, was developed by General Steel Casting Corporation in the very late 1930s for passenger car trucks. The bolster anchor is typically a heavy rod that ties the truck frame to the bolster [9].

The anchor permits the bolster to move vertically while keeping it square with the side frame of the truck. Shock and vibration are minimized by substantial rubber mounts on each end of the rod. Among the earliest applications of a bolster anchor on a diesel truck was in 1949 when Budd used the device on trucks for its RDC commuter cars [36].

SWING HANGERS

Swing hangers are U-shaped links that suspend the bolster spring from the truck frame. The swing hanger may be outside [14] or inside [23] the truck frame. The hanger allows the spring assembly to move from side to side, thus reducing the transfer of shock from sideways movement of the wheels to the body of the locomotive.



BALDWIN LOCOMOTIVE TRUCKS

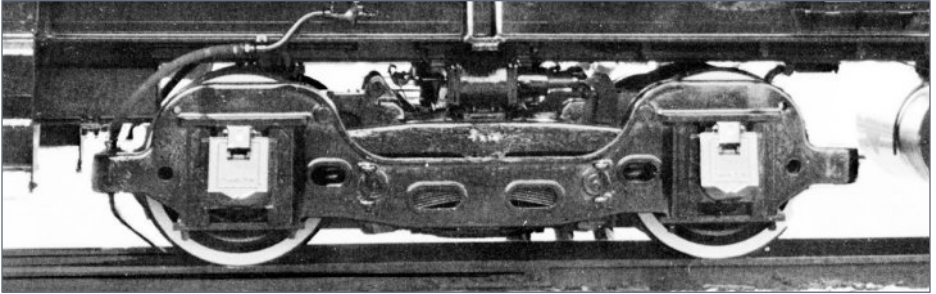

10. The Batz plain-bearing truck was a Santa Fe property licensed to Baldwin which used it on many of its B-B industrial and yard switchers built from the late 1930s into the mid-1950s. This included Baldwin's popular VO 660 and VO 1000 switchers introduced in 1939, and some units in the DS-4-4 series beginning in the post-war period.

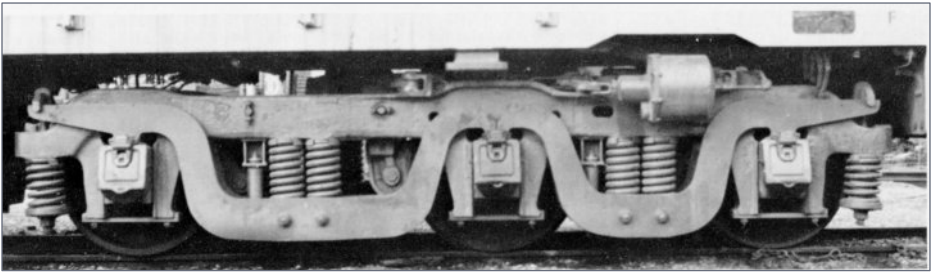

11. Baldwin's RT-624 center-cab transfer units introduced in 1951 used this double drop equalizer truck, except they were equipped with roller bearings. Note the unequal axle spacing on this three-axle, three motor truck.

Get more articles like this

GIVE IT A LIKE



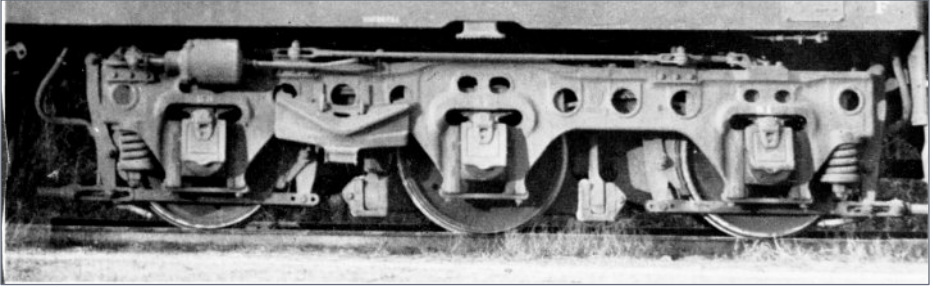

12. Baldwin used this A1A two-motor truck with unevenly spaced axles for its DRS-6-4-15 and AS-416 road switchers built between 1946 and 1955. Note the springs for the straight inside equalizer are visible at both ends of the cast truck frame. Baldwin continued to favor trucks with plain-bearing journals into the late 1950s.

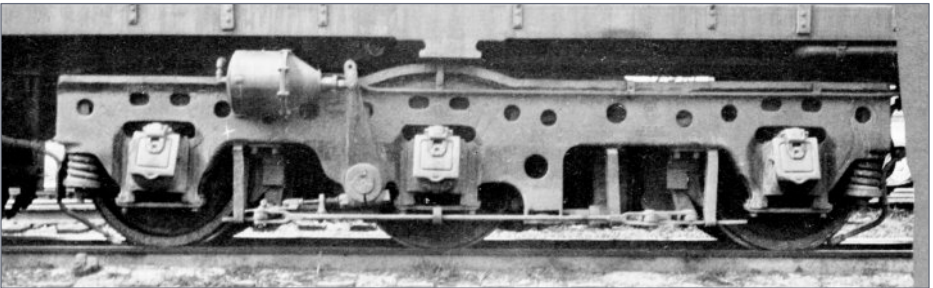

13. This cast-frame truck with 42" wheels and a 13' wheelbase was used by Baldwin on the DT-6-6-20 mid-cab transfer units built in 1948. Lima used it on its 2500hp transfer locos cataloged in 1950. Note the uneven axle spacing, inside equalizers and plain-bearing journals.



EMD LOCOMOTIVE TRUCKS

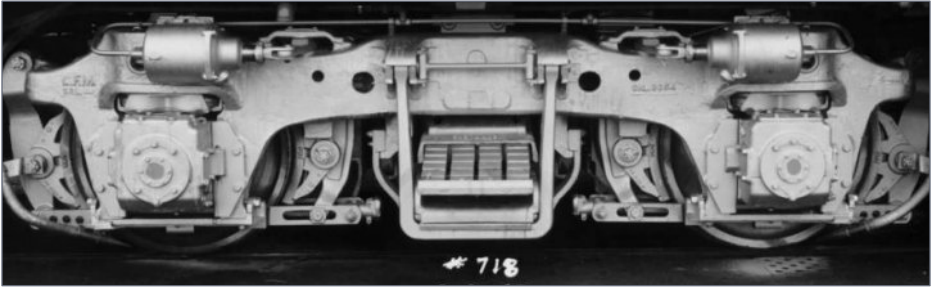

14. EMD's four-wheel two-motor Blomberg B truck was introduced in 1939 on the revolutionary FT freight diesel. The truck had a 9' wheelbase and used 40" wheels. The prominent U-shaped outside swing hanger supporting the elliptical bolster spring assembly helped mitigate sudden jolts and reduced crew fatigue. A pair of small coil springs were positioned above each journal box. This truck, and its variations, served as the principal truck on EMD B-B locomotives including all F and GP units, the MP15 and NW5 switch engines and the F40PH and F59 cowl units. EMD's Blomberg B was arguably the most successful two-axle, two-motor truck design of all time.

**Did you know
there's an MRH/
RE index
available?**

Click to find out more

MARTIN BLOMBERG

EMC/EMD engineer Martin Blomberg incorporated swing hangers in his eminently successful four-wheel [14] and six-wheel diesel trucks.

Blomberg's three-axle A1A truck [19] was specifically designed for the E-series passenger diesel-electric locomotives that debuted in 1937. It featured outside U-shaped swing hangers on the two-section elliptical bolster springs and the visual absence of equalizers. A pair of small coil springs were positioned above each journal box. With minor changes, EMD continued to use this truck on new equipment as late as 1963.

In 1939 Blomberg designed a four-wheel truck that also displayed a prominent U-shaped swing hanger. Known as the Blomberg B, the truck was first used on EMD's revolutionary FT series of diesel-electric freight locomotives. The Blomberg B continues to be seen on locomotives in the 2000s. ■

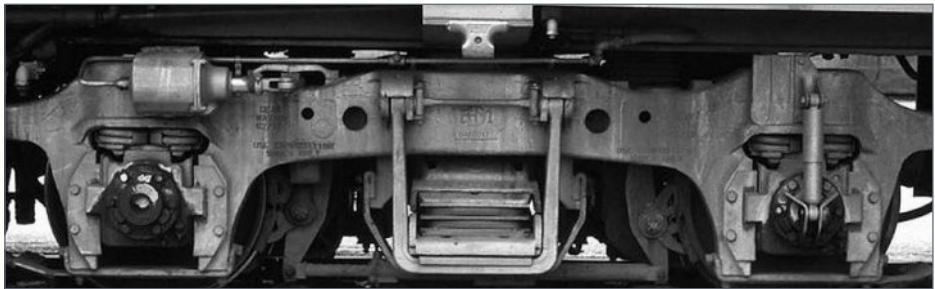

15. The Blomberg M (for modified) truck was introduced in 1972 on EMD GP40 locomotives. Modifications included replacing the elliptical bolster springs with rubber spring pads, which required a slightly shorter swing hanger. Additional changes include adding automotive-style shock absorbers and eliminating the outer brake shoes.



JOURNAL BEARINGS

The application of roller bearings on lightweight passenger cars was almost universal by the late 1930s, but some railroads continued to specify plain or solid-journal bearings on orders for new diesel locomotives well into the 1950s [11, 16].



16. This two-axle two-motor EMD Flexicoil truck had a wheelbase of just 8'. It was introduced in 1954 as an upgrade option on EMD's SW1200 switcher. Both plain- and roller-bearing versions were available.

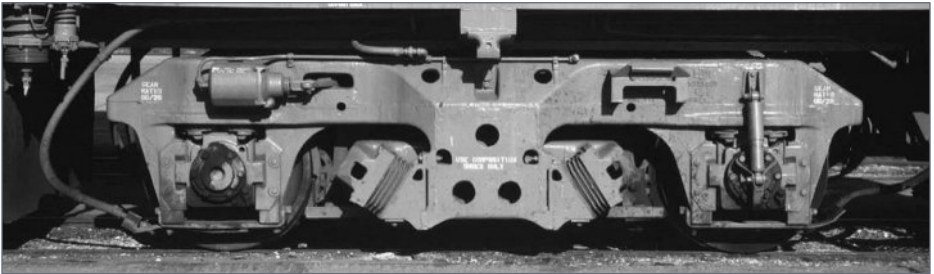

17. EMD's HT-B truck (high-traction, two-axle, two-motor) was developed for the 3500hp GP40X road switcher built in 1977 for the Southern Pacific and Union Pacific railroads. After the initial production run, subsequent buyers specified the thoroughly proven Bloomberg M trucks [15] for their GP40X locomotives.



18. EMD first used this modern truck on the F125 commuter locomotives built from 2015 thru 2021 for the Southern California Metrolink. Note the paired coil bolster springs and the use of three automotive style shock absorbers.

SPRINGS AND SHOCK ABSORBERS

Bolster springs on diesel trucks usually consist of an assembly of elliptical springs of varying lengths. As the elliptical leaves flex against one another they tend to be self-dampening.

Equalizers were almost always fitted with coil springs, which need less space [7]. They provide a softer response, but they can be bouncy and develop harmonic vibrations. To help mitigate the bounce, coil springs require a damping device such as a second inner coil wound in the opposite direction.

Bolster assemblies utilizing coil springs were usually fitted with shock absorbers [18, 30A]. Monroe tubular hydraulic shock absorbers modified for use on railroads were introduced in 1938 [15, 29C].



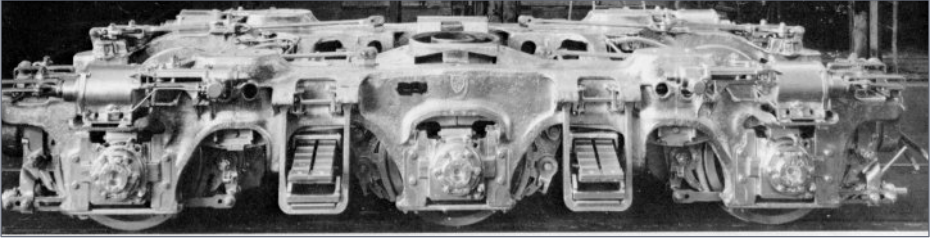

19. Engineer Martin Blomberg designed this two-motor A1A truck in 1937 for EMD's E-series passenger diesels. Distinguishing features include even axle spacing, outside U-shaped swing hangers on the two-section elliptical bolster spring assembly and the visual absence of equalizers. A pair of small coil springs were positioned above each journal box. The truck had a wheelbase of 14'-1". A few were assembled with 36" wheels, but most had 40" wheels. EMD continued to use this truck on new equipment as late as 1963.

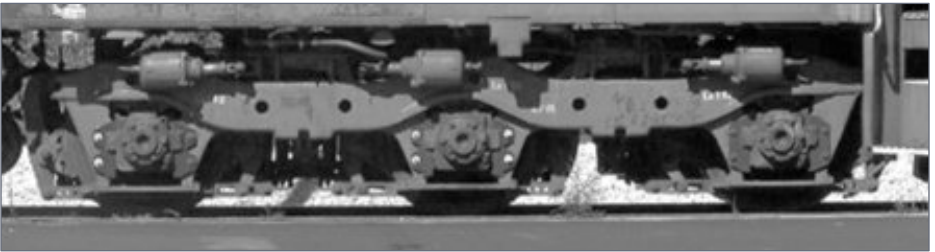

20a. EMD introduced the three-axle, three-motor Flexicoil C1 truck on its SD7 road switcher in 1952. It had 40" wheel on a 13'-7" wheelbase. A spotting feature of the original version had two "teeth" on the underside of the frame casting between each pairing of axles. Equalization of this tri-mount was handled by dual coil springs mounted above each journal. It was subsequently used on all EMD's SD series C-C road switchers.

Get more articles like this

GIVE IT A LIKE



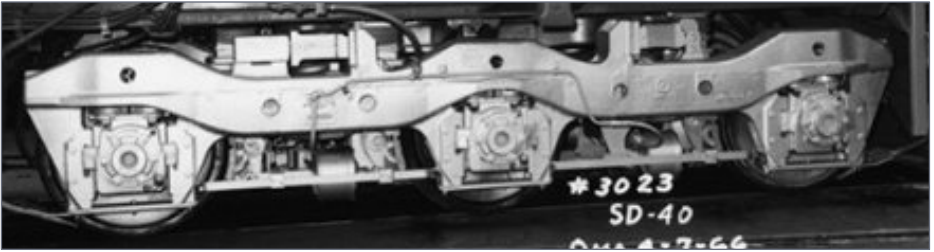

20b. The “teeth” disappeared on latter versions of EMD’s Flexicoil truck as seen on this Union Pacific SD40. Placement of brake cylinders and single-shoe or clasp brakes also altered the appearance of the Flexicoil truck.

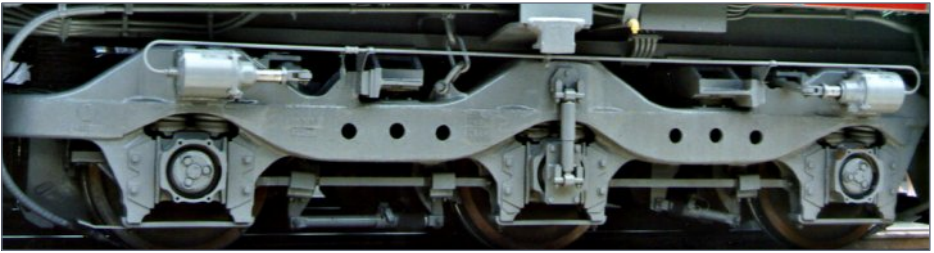

20c. In 1970 EMD introduced the Flexicoil HT-C, a high traction version of the popular Flexicoil truck. In addition to the three non-functioning holes in the casting, note how one end of the HT-C frame has been extended to support the third traction motor which is now outboard of that axle.

Did you see this article?

in the **NOVEMBER 2023 MRH RUNNING EXTRA!**



Improved track
cleaning swabs

Get full eBook now ▶

← click
here

Each eBook has 80-100 pages

MRH

RUNNING
EXTRA



REGISTER
(free)

[INDEX](#)

[TABLE OF CONTENTS](#)

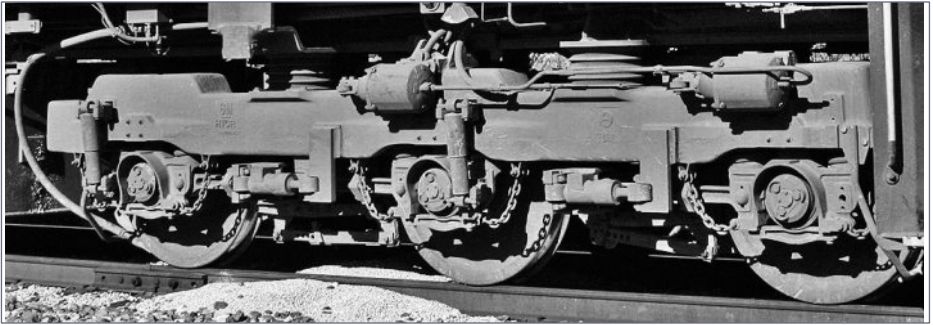

21. EMD's self-steering HTCR-II three-axle, high-traction, radial guided truck was introduced on the SD70 in 1992. It was later available as an option on other third generation diesels including the SD75 and SD80. The HTCR-II was expensive and not without maintenance issues, prompting some of EMD's customers to specify the less expensive Flexicoil truck [20C]. In 2003 EMD introduced the HTSC truck which was essentially an HTCR-II without the complex radial guided components.

SELF-STEERING TRUCKS

Radial self-steering trucks allow the individual axles to align with curves. For non-radial trucks, the more axles in the assembly, the more difficult it is for the truck to negotiate a curve, due to friction between the wheel flange and the rail. On self-steering trucks, the wheel sets actively "steer" through curves which reduces wear of the flange and improves adhesion.

Introduced in 1992 on its SD70 series locomotives, EMD's self-steering high-adhesion HTCR truck [21], met with limited success because of high initial cost and the need for frequent maintenance. EMD introduced the simpler HTSC truck in 2003 which is basically an HTCR without the radial components.

GE introduced their self-steering truck in 1995 [34] as a buyer option for the AC4400CW and later Evolution Series loco-

tives. It suffered the same combined problems of high cost and high maintenance as EMD's HTCR, resulting in customers favoring GE's standard Hi-Ad truck [33] for both new and rebuilt locomotives.

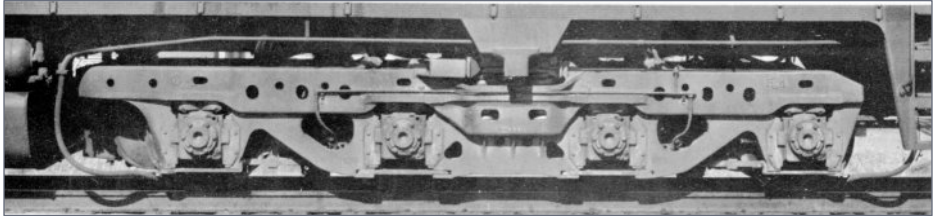

22. EMD's four-motor Flexicoil truck was developed for the 5000hp DD35 locomotive introduced in 1963. It was also used on the 6600hp DDA40X that was produced between 1969 and 1971. Its 17'-1" wheelbase made it the largest truck built for a production locomotive. A less expensive approach was taken by GE, which simply bridged two of their modified Type B trucks [28] with a span bolster for its 5000hp U50. Alco did the same with AAR Type B trucks [2] for the three 5500hp C-855 units it built for the Union Pacific in 1964.

FAIRBANKS-MORSE LOCOMOTIVE TRUCKS

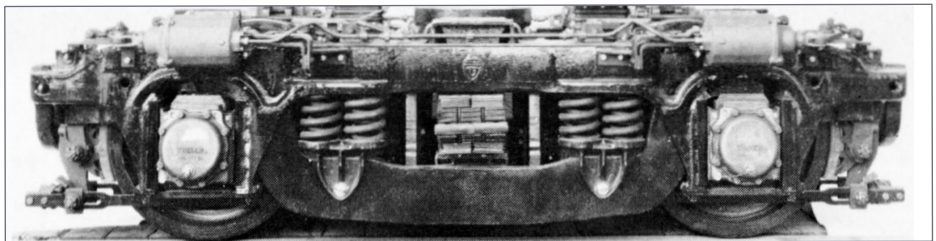

23. Fairbanks-Morse used this two-axle, two-motor truck on its H-16-44 road switcher introduced in 1950. It had a 9'-4" wheelbase and a heavy single dropped equalizer supported by paired coil springs. Passenger versions of F-M's C-Liner series of locomotives introduced in 1949 had this truck up front but required a three-axle A1A truck [3] at the rear to support the steam generator.



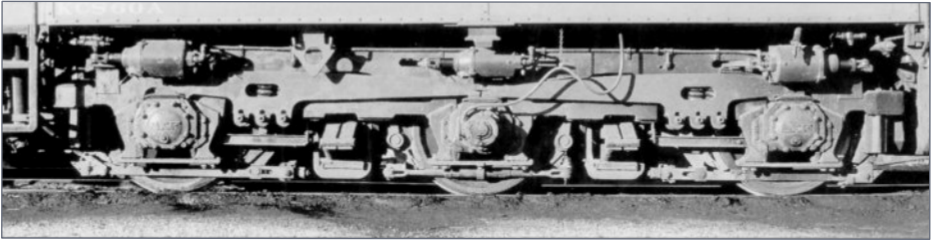

24. This A1A two-motor truck with a 15'-5" wheelbase was used on Fairbanks-Morse cab diesels introduced in 1945. The locomotives were identified as Erie-built because construction had been subcontracted to GE at its Erie PA facility. Since castings were in short supply during WWII, eleven of the first locomotives built were delivered with welded versions of this trucks that General Electric fabricated from stock steel. Subsequent production received A1A trucks [3].

TRI-MOUNT TRUCKS

Instead of a regular bolster arrangement, tri-mount trucks have three mounting pads made up of a proprietary combination of rubber, springs and metal plates. Together the three mounting points hold the truck frame in the same plane as the frame of the locomotive. Details on a tri-mount trucks are not visible on a model.

Did you see this article?

in the **NOVEMBER 2023 MRH RUNNING EXTRA!**



More bulletproof
layout details

Get full eBook now ▶

← click
here

Each eBook has 80-100 pages

MRH

RUNNING
EXTRA



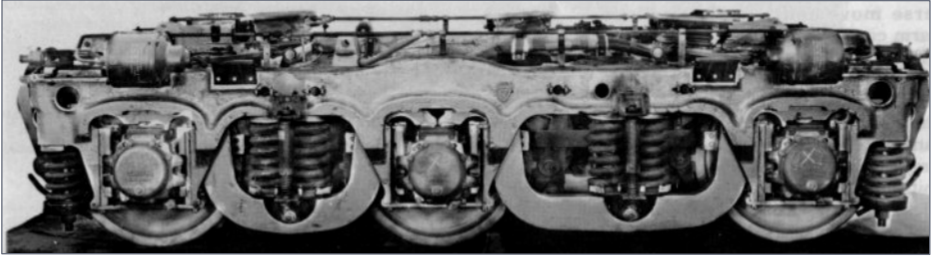

25. Fairbanks-Morse introduced its impressive Train Master series of locomotives in 1951 with the H-24-66 and H-16-66 [Baby Train Master]. Some rode on a truck supplied by Baldwin [13], but most of the heavy road switchers were delivered with this proprietary C-C three-motor truck with uneven axle spacing. Secondary springs for the single dropped equalizers are visible at both ends of the cast frame. This Train Master truck had a wheelbase of 13'. Compare the single inside equalizers on this truck with the double drop equalizers on the truck in [11].

GE LOCOMOTIVE TRUCKS

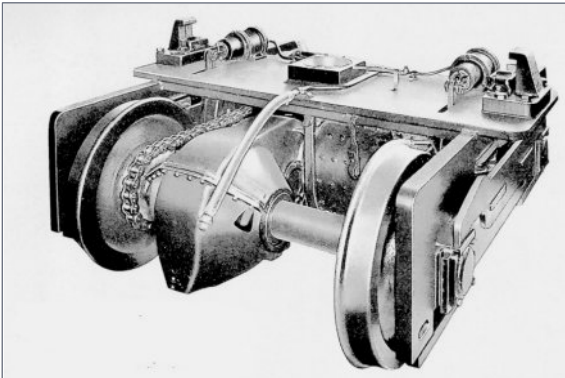

26. GE's 44 ton industrial switcher introduced in 1940 used this two-axle all-welded truck with 33" wheels. The trucks had one axle motorized with the second axle connected by a chain drive. Note the small king pin center plate and the side bearings

mounted on the ends of the slab bolster.



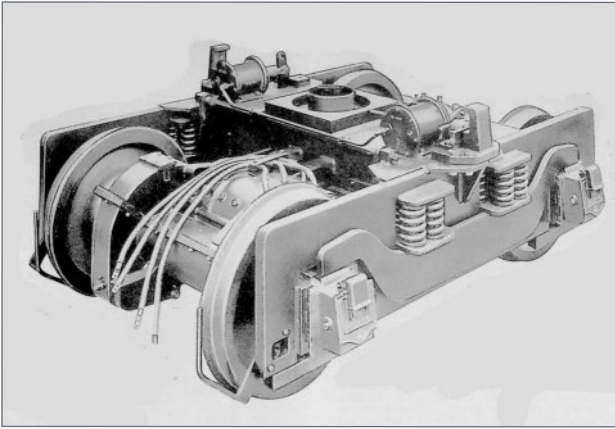

27. General Electric's industrial switchers rated from 50 to 95 tons used the same fabricated truck as in [26], however both axles carried traction motors. Note the dropped outside equalizer and pedestal tie bar below the plain bearing journal boxes.

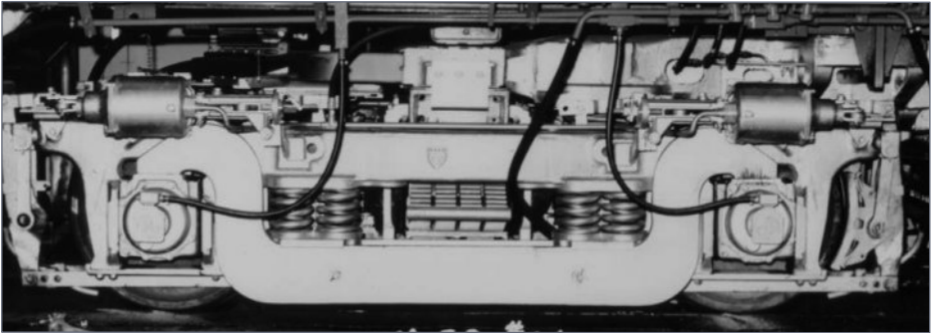

28. This is General Electric's beefed up, and slightly longer (9'-4" wheelbase) version of the common GSC Type B truck [2]. The four-section elliptical bolster springs are suspended on inside swing hangers behind the double drop equalizer. GE used this truck on most of its B-B locomotives until the introduction of the Floating Bolster truck [29] in 1969.

Get more articles like this

GIVE IT A LIKE



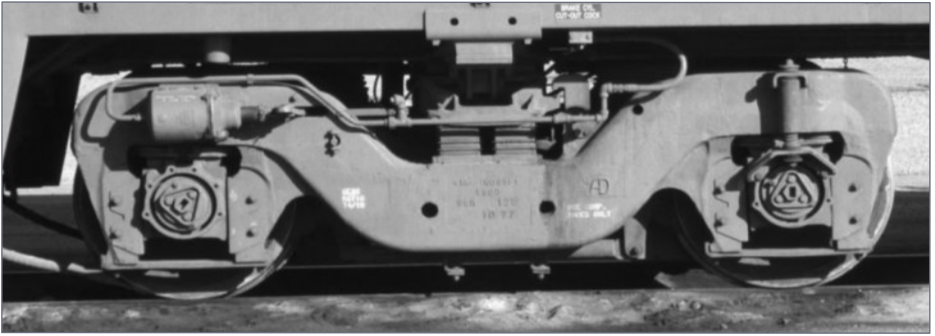

29a. GE introduced this FB-2 floating-bolster truck in 1969. The new design featured a bolster mounted on rubber and metal spring pads, which theoretically allowed the bolster to “float” over the truck frame. By 1972 the FB-2 truck was virtually a standard on all new GE B-B locomotives including the third-generation microprocessor-controlled U18B, most Dash 7 units, and the Dash 8-32BWH built for Amtrak in 1991. Castings for GE’s FB-2 truck were supplied by at least two foundries. Those delivered by Adirondack are identified by two non-functional holes below the bolster and a single small hole to the left of the right axle.

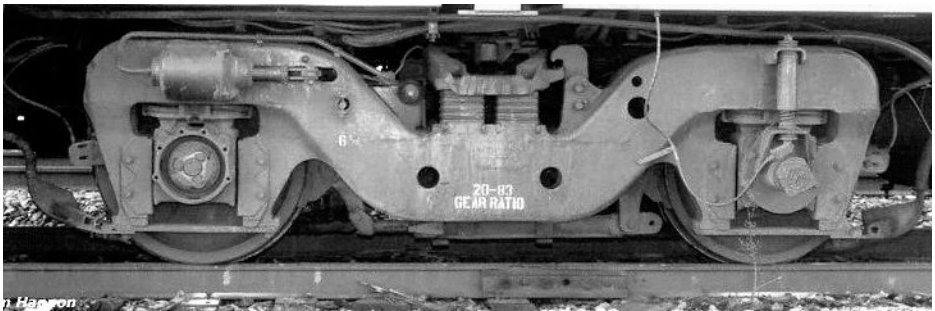

29b. GE FB-2 truck assembled from early Rockwell castings. Spotting features include slightly larger holes below the bolster and one additional large hole near the right wheel [29b].



REGISTER
(free)

[INDEX](#)

[TABLE OF CONTENTS](#)

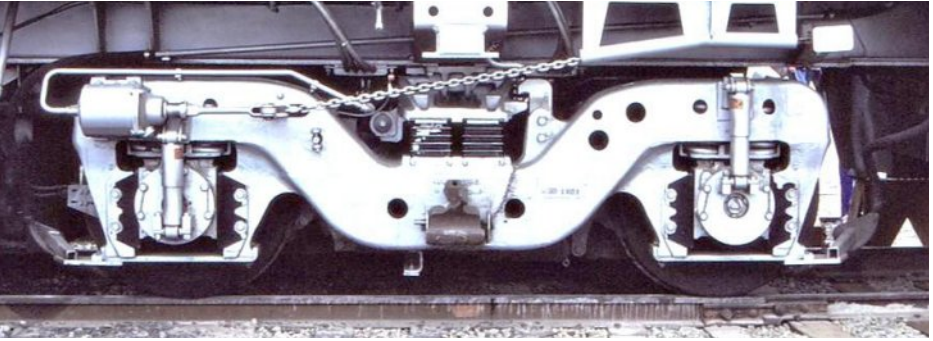

29c. GE FB-2 truck assembled from later Rockwell castings. Note the additional holes in the cast frame, black pedestal liners, dual automotive-style shock absorbers and the taut chain from the hand-operated parking brake.

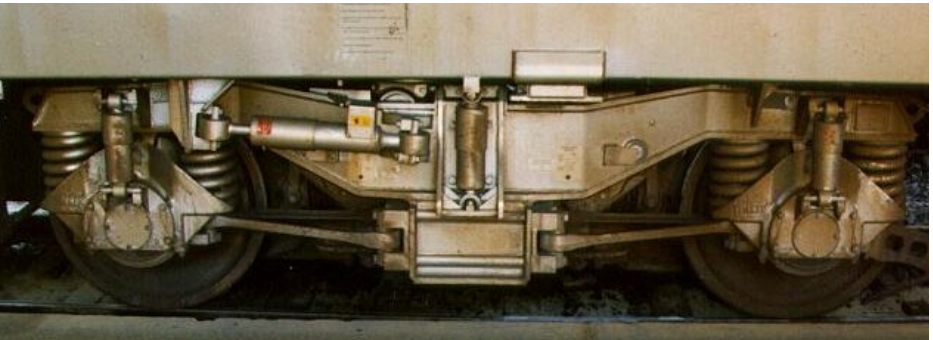

30a. GE applied this truck on its Genesis P40, P42 and P32 locomotives built for Amtrak beginning in 1992. The high-speed truck was designed and built for GE by Krupp-MaK, a German supplier of railroad products that has since been absorbed by Siemens Mobility.

Get more articles like this

GIVE IT A LIKE



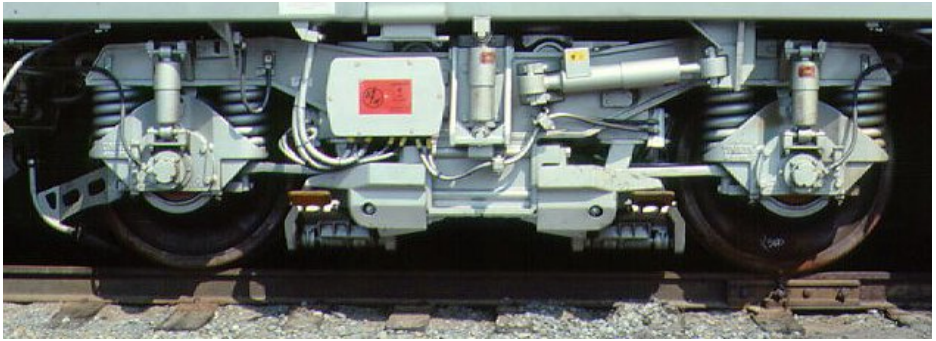

30b. GE-Krupp truck with third-rail shoes for use on GE's P32AC-DM, (AC traction, Dual Mode) built for Northeast Corridor service. The shoes allow the P32AC-DM to switch over to electric only mode as it approaches the tunnels leading to New York's Penn Station.



R. Bale

WHEN LOCOMOTIVE AND TRUCKS DON'T MATCH

Certain locomotive components, notably trucks, tend not to wear out as quickly as engines, generators, and other appliances. When buying new locomotives, it is not unusual for the customer to trade-in older locomotives and arrange for the trucks to be refurbished and used on the new purchase.

Occasionally this results in some unusual match-ups, such as EMD trucks under a new GE locomotive. EMDs smooth-riding Blomberg B was a favorite that appeared under a wide range of non-EMD two-axle locomotives.



REGISTER
(free)

[INDEX](#)

[TABLE OF CONTENTS](#)

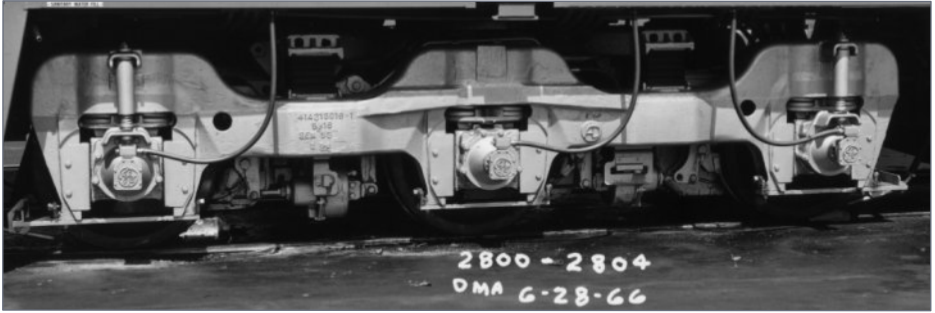

31. Adirondack supplied GE with the castings for this three-axle three-motor truck for five U28Cs ordered by the Union Pacific. Most other customers of the U28 series specified GE's FB-3 truck [32]. It was also used on U30CG cowl units built in 1967 for Santa Fe and some U36CG units built in the mid-1970s for the National Railway of Mexico. The spotting features on this truck are the protruding shelf above the center axle and the automotive-style shock absorbers above both outside axles.



32a. Identified as model FB-3, this floating-bolster truck first appeared in 1956 under GE's U30C. It continued to be used on C-C locomotives through the Dash 8 series. GE used castings made by both Adirondack and Rockwell. Spotting features of the Adirondack FB-3 frame include a boxy shape above the outer axles and two widely spaced non-functional holes in the casting.

Get more articles like this

GIVE IT A LIKE



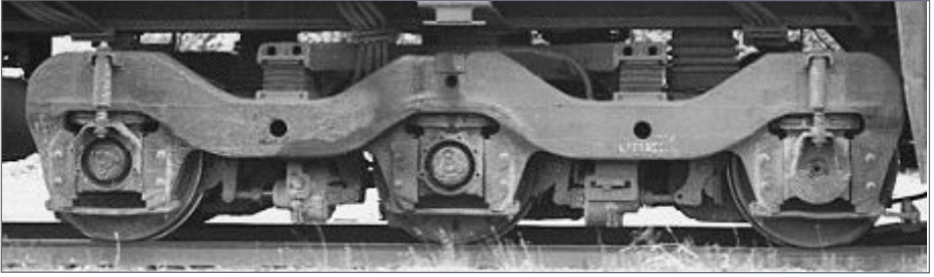

32b. The larger holes in Rockwell's version of GE's FB-3 truck are centered between the axles. A smaller hole is located above the middle axle.

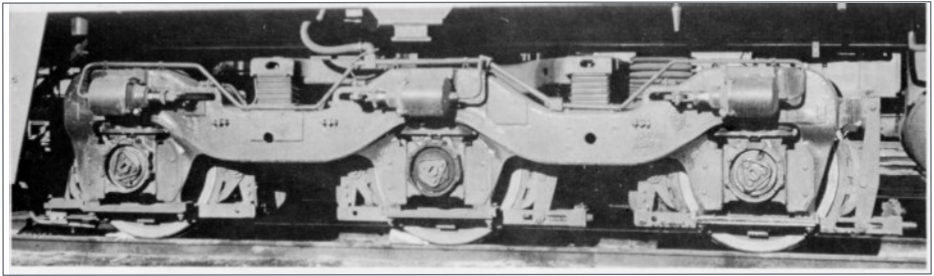

32c. The installation of brake cylinders and rigging alters the appearance of all trucks including this FB-3. GE's FB-3 truck is similar in appearance to EMD's three-axle Flexicoil truck [20b] and shares the same 13'-7" wheelbase.

Please click on the ads to
support
Model Railroad Hobbyist!



REGISTER
(free)

[INDEX](#)

[TABLE OF CONTENTS](#)



33a. GE's three-motor Hi-Ad (high adhesion) floating-bolster truck was introduced in November 1993 with the release of the microprocessor-controlled third-generation Dash 9-44 units. Subsequent applications include GE's ES44 series launched in 2003 and the ET44 series that followed in 2015. Dofasco worked with GE in developing this truck. In addition to conventional springs, the new truck had a secondary suspension system consisting of four stacks of rubber pads connected directly between the truck and the locomotive under frame.

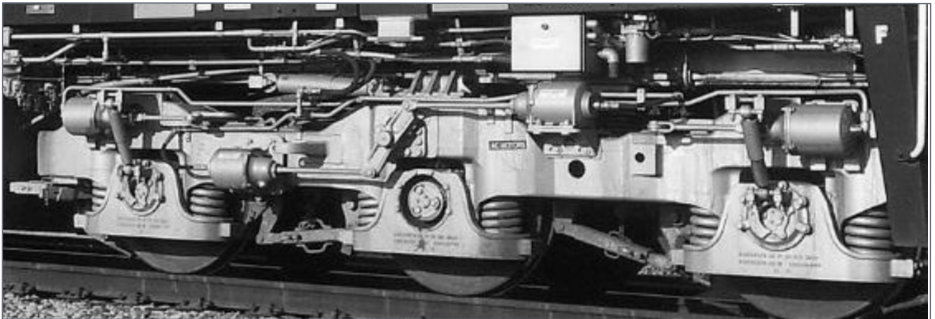

33b. This is a two-motor A1A version of GE's Hi-Ad CC truck [33a] modified for use on ES44C4 and ET44C4 units. The air cylinders and linkage mounted on the frame of the truck are part of the locomotive's computerized traction control system. In response to variations in grade, traction, or wheel slip, the computer adjusts the pressure in these cylinders to maintain sufficient adhesion, by varying the weight on the drive axles.



34. GE's self-steering truck was initially offered in the mid-1990s as a customer option on its AC4400CW and later Evolution Series locomotives. The revolutionary truck met with limited acceptance due to its relatively high initial cost and excessive maintenance requirement. Most subsequent customers opted for GE's standard Hi-Ad truck [33A] for new and rebuilt locomotives.

MISCELLANEOUS TRUCKS

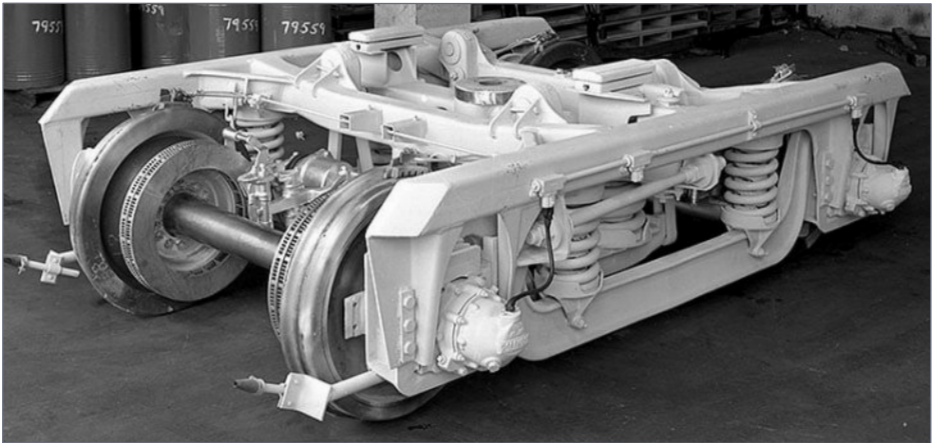

35. Budd used this two-axle one-motor truck with a fabricated frame on Phase 1 RDCs built between 1949 and 1955. Note the disc brakes, I-beam-shaped drop equalizer, and the use of an anchor bolster. It also used a hydraulic torque converter (aka transmission) instead of an electric motor.



REGISTER
(free)

[INDEX](#)

[TABLE OF CONTENTS](#)

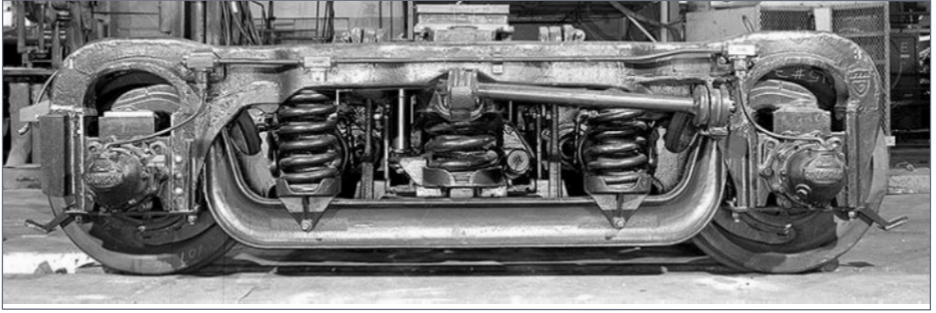

36. Phase 2 production of Budd RDCs, which began in 1956, used this two-axle one-motor truck with a cast frame. Its design was fundamentally the same as the original welded frame truck [35] used on Phase 1 RDCs.

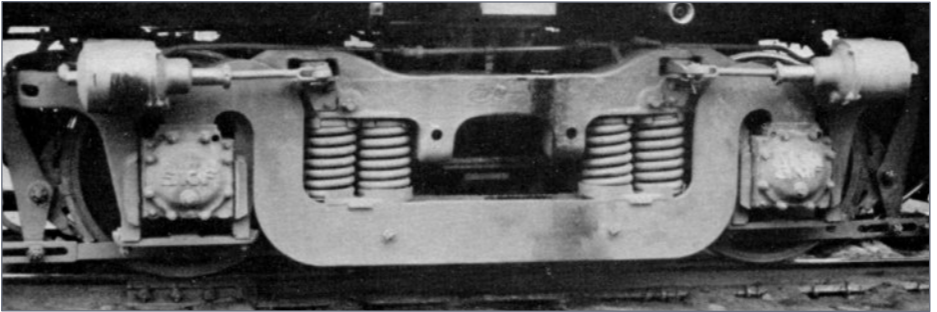

37. Inspired by a fundamental AAR Type B design, Dofasco developed and manufactured this equalized pedestal type truck which Montreal Locomotive Works used on its Century series locomotives. This Canada-only truck with a 9' wheelbase was also used on RS-10, RS-18 and RS-23 switchers built by MLW.



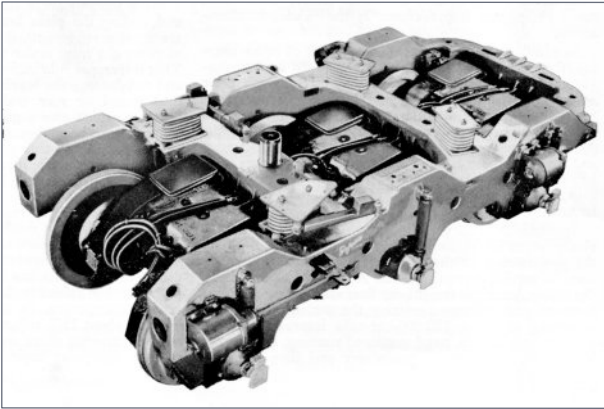

38. Dofosco high adhesion C-C truck used on MLW-Worthington M630 and M636 locomotives.

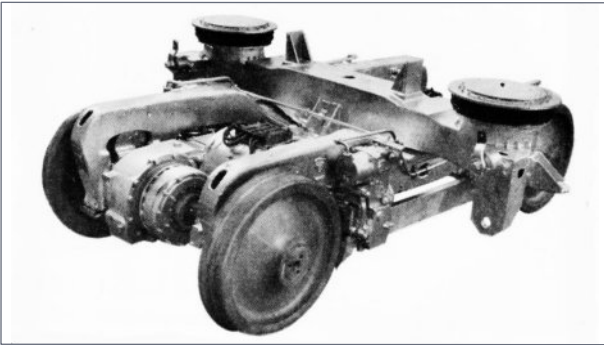

39. The General 70-series trucks introduced by GSI in the 1970s included a wide range of inside-frame, air-spring trucks for light rail and rapid transit applications.

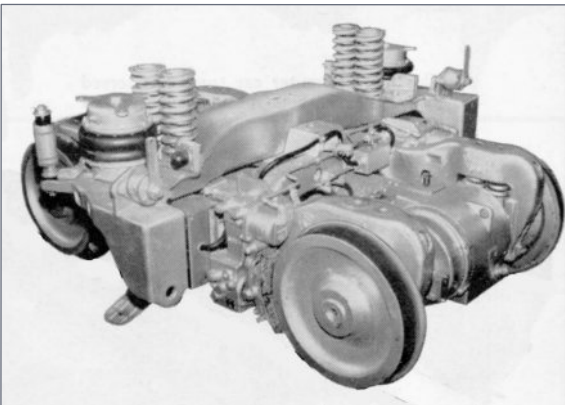

40. GSI series 70 truck with third rail shoe. Note paired coil bolster springs.



REGISTER
(free)

[INDEX](#)

[TABLE OF CONTENTS](#)

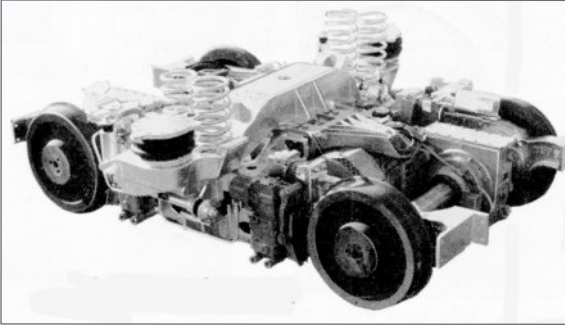

41. A later version of GSI's General 70 truck featured improved braking.



42a. Siemens-Mobility SF4 two-axle two-motor truck.



42b. Siemens-Mobility SF4 truck under an ACS-64 Amtrak Cities Sprinter. The SF4 was also used on the ALC-42 and SC-44 Charger locomotives. Note the shock absorber linked to the body.

INDEX

- Alco A1A truck, Fig 7
- Alco Blunt B-B truck, Fig 5
- Alco C-C truck, Fig 8
- Alco Hi-Ad B-B truck, Fig 6
- Alco Hi-Ad C-C truck, Fig 9
- ARA A1A truck, Fig 3
- ARA Type A, B-B truck, Fig 1
- ARA Type B, B-B truck, Fig 2
- Baldwin A1A truck, Fig 12
- Baldwin Batz B-B truck, Fig 10
- Baldwin C-C truck, Fig 11 and 13
- Batz B-B truck, Fig 10
- Blomberg B, B-B truck, Fig 14
- Blomberg M, B-B truck, Fig 15
- Blunt B-B truck, Fig 5
- Budd B-B truck, Fig 35 and 36
- Dofosco Type B, B-B truck, Fig 37
- Dofosco Hi Ad C-C truck, Fig 38
- EMD A1A truck, Fig 19
- EMD Blomberg B, B-B truck, Fig 14
- EMD Blomberg M, B-B truck, Fig 15
- EMD F125 B-B truck, Fig 18
- EMD Flexicoil B-B truck, Fig 16
- EMD Flexicoil C-C truck, Fig 20A
- EMD Flexicoil D-D truck, Fig 22
- EMD HT-B, B-B truck, Fig 17
- EMD Flexicoil HT-C, C-C truck, Fig 20C



EMD HTCR-II C-C truck, Fig 21
F-M A1A truck, Fig 24
F-M B-B truck, Fig 23
F-M C-C truck, Fig 25
GE Adirondack C-C truck, Fig 31
GE B-1 truck, Fig 26
GE B-B truck, Fig 27
GE FB-2 B-B truck, Fig 29
GE FB-3 C-C truck, Fig 32A, B and C
GE Hi-Ad C-C truck, Fig 33A and B
GE Krupp B-B truck, Fig 30
GE modified Type B, B-B truck, Fig 28
GE Self-Steering C-C truck, Fig 34
GSC Type A, B-B truck, Fig 1
GSC Type B, B-B truck, Fig 2
GSI Series 70 B-B truck, Fig 39, 41
GSI Series 70 third rail truck, Fig 40
MLW Modified Type B, B-B truck, Fig 37
Siemens SF4 B-B truck, Fig 42A and B

BIBLIOGRAPHY

Car & Locomotive Builders Cyclopedia, 1946, 1970, 1984 editions.
The Contemporary Diesel Spotter's Guide, Louis A. Marre, 1995
Diesel Demonstrators, Karl Erk, 2007
Diesel Era Magazine, various.
Diesel Locomotives, Bob Hayden, 1980
Diesel Locomotives: The First 50 Years, Louis A. Marre 1995
Diesel Spotter's Guide, Jerry A. Pinkepank, 1967

General Electric Diesel-Electric Locomotives, 1950 Mfg Catalog
General Electric Industrial Locomotives 1924-1978, O. M.
Kerr 1969

Guide to North American Diesel Locomotives, Jeff Wilson, 2017
Locomotives: The Modern Diesel and Electric Reference, Greg
McDonnell and Jerry Pinkepank 2015

Santa Fe's Diesel Fleet, Joe McMillan, 1975

The Second Diesel Spotter's Guide, Jerry A. Pinkepank, 1973

PHOTO CREDITS

Broadbelt, Fig 10; Budd Co. Archives, Fig 36; Eddie Duwald, Fig 21; EMD, 19; General Electric Archives, Fig 26, 27, 28; Tom Hampton, 29B; Warren Johnson, Fig 14, 20, 31; John Kuehl, Fig 6; Louis B. Marre, Fig 5, 7, 8, 12, 13, 24; Marre-Mott Collection, Fig 3, 9; Metrolink, Fig 18; Rick Morgan, Fig 2; Gordon Mott, Fig 22; Museum of American Railroad, Fig 3; Ernest Novak, Fig 15; Railroad Museum of Pennsylvania, Fig 35; Siemens Co., Fig 38; Don Stack, Fig 29A; Robert LaMay Fig 30B, F. H. Wagner, Fig 32; and Larry White, Fig 37.

Get the bonus download:

[Table of all diesel locos and what trucks they came with](#)

Did you see this article?
in the **NOVEMBER 2023 MRH RUNNING EXTRA!**



**Modeling the Royal
Chair Factory**

Get full eBook now ▶ ← *click here*

Each eBook has 80-100 pages

MRH **RUNNING**
EXTRA

Get more articles like this

GIVE IT A LIKE



REGISTER
(free)

[INDEX](#)

[TABLE OF CONTENTS](#)

What's new on TMTV

Some recent shining examples ...



Effective scenery modeling series



Dallas 2023 Train Show highlights



3D printing: Print out the building design



Demystifying frog wiring

Watch now ...

Buy individual episodes or get unlimited access as a member



www.trainmasters.tv

Registered MRH reader?

SAVE 10%
click here

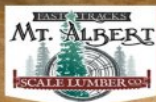

Introducing THE LUMBER STORE



ROTATING STORAGE RACK

On its own, or fully loaded with Mt. Albert Scale Lumber!

handlaidtrack.com

1-888-252-3895

Do ALL your model railroading friends know about MRH?

WE CONTINUE TO BE SURPRISED BY HOW MANY
MODELERS STILL HAVE NEVER HEARD OF US - SO
SPREAD THE GOOD WORD ABOUT MRH!



REGISTER
(free)

[INDEX](#)

[TABLE OF CONTENTS](#)

Kitbashing a stockyard



Model Railroad Hobbyist | November 2023

DAVID NATION SHOWS HOW
HE BUILT A STOCKYARD...



I NEEDED A SMALL STOCKYARD FOR MY FICTIONAL DUSTY JUNCTION and Northwestern branch line, but could not find one that fit the available space. This is how I kitbashed mine.

The whole project got started when I received an N-scale Architect windmill kit as a gift [1]. This got me thinking about how I could use it and where it would make sense.

I happened to be switching some cattle cars that evening and the idea hit me. I needed a small stockyard.

I started searching for available stockyard kits, but found nothing that matched what I had in mind. I then started looking for kits I could bash into a stockyard, and found these cattle ramps and a small shack from GCLaser [2].

I started researching stockyards along the Santa Fe, and found the standard-size pen was 50'x50' or larger. This equates to 3.75 inches square for each pen in N scale. I only had 3.5 inches total depth available, so I had use selective compression.



1. Architect windmill kit.



2. These two cattle ramps and small shack from GCLaser became the basis for my stockyard.



REGISTER
(free)

[INDEX](#)

[TABLE OF CONTENTS](#)

KITBASHING A STOCKYARD | 3

I made a 3.5 x 9.5-inch styrene base template to match the available area. I then made a grid of half-inch squares, and started laying out everything and mocking-up the pattern. I ended up going with 20x20-foot pens, which is 1.5 inches square in N scale or 3x3 on my half-inch grid.

I hand-drew a template on a scrap piece of paper for the fencing and using double-sided tape I laid out and glued together each fence section. I took care to make sure the cross boards were on the inside of the posts so that they could not be pushed off by the animals

I used Northeastern Scale Lumber for the fencing. 1x3 HO strips, roughly 2x6 N scale, formed the cross boards, and 3x3 HO strips, roughly 6x6 N scale, formed the posts.

I cut the regular posts to be six feet tall and set them six feet, eight inches apart. I know this is not exactly prototypical, but



3. I laid out the first pen and ramp and glued them to the styrene base. The square with the hole is the future site for the windmill.

it conveys the correct feel, and it was easy to lay out on my half-inch grid template. I cut the posts for the gates to be 10 feet tall [3].

I put cross boards on both sides of the posts for the middle fences and along the back of the pens, again following standard practice to prevent the animals from pushing the boards off.

I scratchbuilt a hay shed using the same pattern as for the fences, but added a floor and roof.

For hay bales, I used 3/32 x 3/32" balsa, cut to 1/4-inch in length. This equates to the bales being about 14 inches square on the end and 3'-4" long. If not exactly prototypical, it looks close in N. I painted the bales tan, and then sprinkled a mixture of very short yellow and green static grass into the wet paint.

I painted the pen floors with tan acrylic paint, and sprinkled on a tan-colored – called “Fawn” – unsanded grout to simulate dirt. Once everything was dry, I vacuumed up the excess [4].

I spent a lot of time searching online for anything available for the water troughs, but could not find anything. A friend from

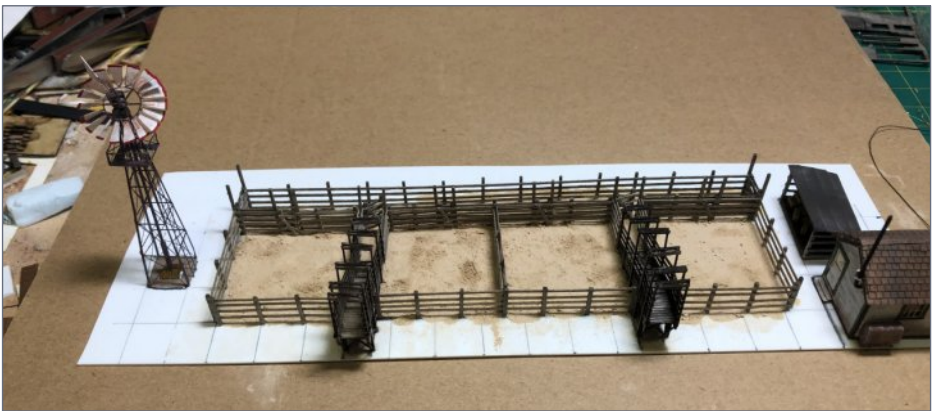

4. The basic structures and tan dirt floor are in place.



www.theRailWire.net suggested using the ferrule from a standard pencil. This was the perfect solution.

I cut off half the ferrule, and removed the eraser [5]. I painted these an aluminum color and filled them with Woodland Scenics Realistic Water.

I scratchbuilt the feed troughs using a pattern derived from several examples I found on the internet. I then filled these using the same yellow and green static grass mixture I used to create the hay bales. I also sprinkled a little on the dirt to simulate split hay [6].



5. I cut off the ferrule from a standard pencil to create the water troughs.



6. With the water and feed troughs in place. This view also shows the boards on both sides of the middle fencing.

I made cow patties from dark brown paint mixed with grout. I dropped small globs randomly around the pens.

I made a large water trough from a piece of plastic I found in my parts bin. I painted it aluminum, filled it with Woodland Scenics Realistic Water, and put it by the windmill.

I added piping, figures, ground cover and cows to complete the scene [7-9].

Now I just need to install it on the layout!

SHOPPING LIST

Windmill Kit from N-Scale Architecture

thenarch.com/product/wind-mill-water-pump-etched-brass-kit-n

Stock loading ramps from GCLaser

www.gclaser.com/n-scale-stock-loading-ramp

Shack from GCLaser

www.gclaser.com/n-scale-west-end-shack

Lumber from Northeast Scale Lumber

www.northeasterscalelumber.com/products/ho-scale-lumber.html?p=1



7. Windmill, water trough, piping, and a worker mucking the pen.



REGISTER
(free)

[INDEX](#)

[TABLE OF CONTENTS](#)



8. The center pens with some cows eating, some drinking, and some milling around.



9. Shack and hay barn.

PolyBlend Non-Sanded Grout from Home Depot
www.homedepot.com/p/Custom-Building-Products-Polyblend-Plus-122-Linen-10-lb-Unsanded-Grout-PBPG12210/313296534 ✓

DAVID NATION



David got started in the hobby during his junior high school years with a basic 4x8 under-the-bed layout. Due to frequent relocations, the layout did not last long. During college, David was able to build a “real” layout, which was the epitome of the spaghetti bowl – far too much track and insane grades.

In 1996, David started the first iteration of the freelanced “Dusty Junction,” which was loosely based off Malcolm Furlow’s San Juan Central. This also was short-lived when he and his wife moved into a new house.

In 2004 started what would become the current “Dusty Junction,” but work, family and converting to a double-deck format have provided many obstacles along the way.

David has been a programmer since 1990 and is looking forward to the day when he can finally retire. He is married to Jackie, and they have a daughter who lives nearby.

In addition to trains, David enjoys reading, computer games, bowling, and drawing. ■

Get more articles like this

GIVE IT A LIKE



REGISTER
(free)

[INDEX](#)

[TABLE OF CONTENTS](#)

NEW

from the
**Model Railroad
Hobbyist** *Store*

Running time:
3 hrs 16 min

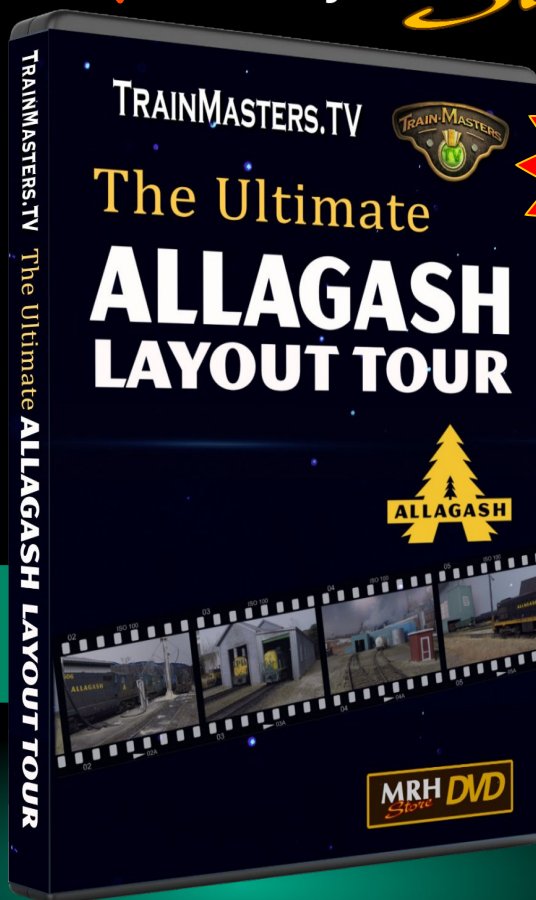

Download
~~\$19.99~~

\$9.99

DVD
~~\$30.00~~

\$21.77



Available NOW

Get Video
Download

Download in full 1080 HD

2-disk DVD set Available NOW

Get
2 DVD Set

DVDs: FREE SHIPPING US
50% OFF SHIPPING FOREIGN

WAIT!

**MRH helps
you avoid
breaking the
bank!**

SPECIAL DEAL:

Subscribe now and get
the next 12 issues plus
ALL 57 BACK ISSUES!



MRH **RUNNING**
EXTRA
Apprentice with savvy modelers

2.99 per 240+ pgs

**Get
MRH
Running Extra**

[click here](#)



REGISTER
(free)

[INDEX](#)

[TABLE OF CONTENTS](#)

SAVVY MODELER *Online*



Get more articles like this

GIVE IT A **LIKE**



Model Railroad Hobbyist | November 2023



Scratchbuild your own telephone poles

In this 8-minute video, YouTuber **Mikehotrains** shows how he scratchbuilds HO telephone and power poles using styrene tubes and styrene strips.

We like the method Mike uses to make the styrene tube stock look like grainy wood. His approach for building transformers, adding wires, and modeling pole arm insulators is clever – definitely worth a watch.



▶ GREAT MODELER VIDEOS ON THE WORLD WIDE WEB



Amherst Railway Society

presents

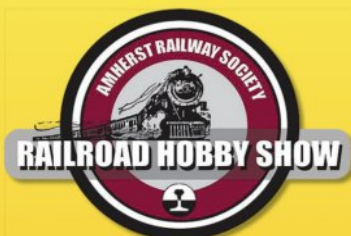

January 27 & 28, 2024

Eastern States Exposition
1305 Memorial Avenue
West Springfield, Massachusetts 01089

railroadhobbyshow.com

operating model railroads
railroad art and photography
railroad books and videos
model railroad clinics
family entertainment
tourist railroads
collectibles

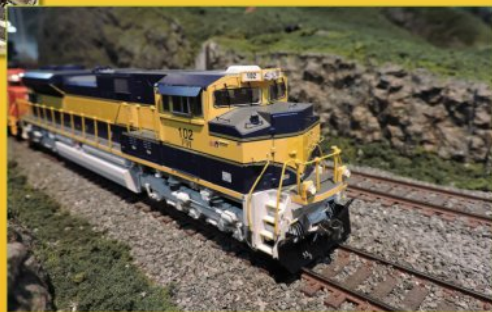

America's largest railroad-themed trade show



amherstrail.org

Eastern States Exposition is the home of the BIG E Agricultural Fair



REGISTER
(free)

[INDEX](#)

[TABLE OF CONTENTS](#)

NOVEMBER NEWS

column



Model Railroad Hobbyist | November 2023

RICHARD BALE AND JEFF SHULTZ

REPORT THE LATEST HOBBY

INDUSTRY NEWS ...



INDUSTRY NEWS



Frederick Raoul Martin of West Seattle, WA, passed away September 9, 2023. He was 87 years old. Raoul was a lifelong train and trolley fan and was one of the founders of The Northwest Railway Museum in Snoqualmie, WA. In 1958 he established Northwest Short Line to import brass models from Japan. Later he added an in-house machine shop to

produce precision components for hobbyists and manufacturers. Notable products include the popular Chopper and an under-floor HO power truck known as The Flea. The NMRA honored Martin with a Distinguished Service Award in 2002. He is survived by his wife Sheryl who helped manage the family business.

Morning Sun Books has announced that after 2024 it will discontinue printing new titles. According to Steve Yanosey older titles will continue to be available, but no new titles will be added. The publisher will continue to offer new digital releases in eBook format as well as digital reprints of older titles.

THE LATEST MODEL RAILROAD PRODUCTS, NEWS & EVENTS

MRHMAG.COM

[INDEX](#)

[TABLE OF CONTENTS](#)

ALL SCALE PRODUCT NEWS

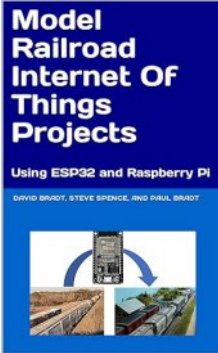

David Bratt, Steve Spence, Paul Bratt, and Joanna Opaskar have released a new book titled *Model Railroad Internet of Things Projects: Using ESP32 and Raspberry Pi*. In 12 projects, topics such as the ESP-NOW protocol, MQTT, and JMRI are demonstrated and used, starting with two ESP32 boards communicating through ESP-NOW and progressing to building a speedometer, an interlocking yard control in JMRI, and two different throttles. Published on Amazon, the book is available in both Kindle and Paperback editions.

Info: www.amazon.com/Model-Railroad-Internet-Things-Projects-ebook/dp/B0CK7SVCXH

HO SCALE PRODUCT NEWS

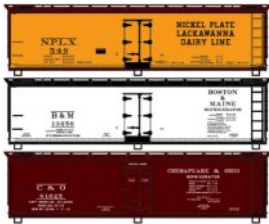

The latest HO scale freight car kits from **Accurail** include a 3-pack of 40' wood reefers. The injection molded plastic models represent a prototype built in the 1920s with wood sides and ends and 4' swing doors. Decorating schemes are NPLX – Nickel Plate Lackawanna Dairy Line, Boston & Maine and Chesapeake & Ohio.



This Archer Daniels Midland triple-bay covered hopper is available as an Accurail kit in two road numbers. The HO scale model is based on a prototype ACF built in 1988.

Accurail is offering a 3-pack of HO scale kits for 40' steel boxcars in three different road names including Atlantic & East Carolina



(The Tobacco Belt Route), Seaboard Air Line and SSW-Cotton Belt (Blue Streak Fast Freight).



This twin-bay ACF covered hopper decorated for Burlington Northern Santa Fe is available in two road numbers.



This group of 40' reefers with ice bunkers, steel underframes and wood sides and ends were built with 4' insulated swing doors. Road names are NRC-Bridgeman-Russell Dairy Company, MERX - Oscar Mayer Meat and DAMX-Dewey & Almy Chemical Co. (Multibestos Brake Lining).

All Accurail HO scale car kits come with appropriate trucks with Delrin wheelsets and Accurail knuckle couplers. Models offered in 3-packs are also available individually.

Info: www.accurail.com



R. Bale

EMD SD70ACU LOCOMOTIVE

The 4,300hp SD70ACU diesel locomotive was created in 2015 when the Norfolk Southern Railway launched a program to update its older EMD SD90MACs. The rebuild included installation of the latest EMD cab

that met the then-current FRA crashworthiness standards, replacing the Siemens electrical control package with Mitsubishi electronics, and completely refurbishing the V16 prime mover. In 2018, the Canadian Pacific Railway began a similar rebuild program for its SD90MAC fleet. In addition to new electronics and cabs, CP raised walkways for better snow management and changed the front plow.

In November of 2019, Canadian Pacific unveiled five updated SD70ACU locomotives decorated in distinctive paint schemes that commemorated the Allied Armed Forces June 6, 1944 D-Day invasion of Normandy, France. **Athearn** is preparing six Genesis series SD70ACU HO scale models decorated in the same military-inspired tribute schemes.



CP locomotive No. 6644 will wear the camouflage colors applied to Spitfire fighter planes flown by the Royal Canadian Air Force at the Allied invasion of Normandy.



CP 7023 is decorated in the two-tone gray paint scheme currently applied to Canadian and American fighter jets.



CP 7020 will be decorated in the North Atlantic Treaty Organization green, which the Canadian and U.S. Armies apply to fighting vehicles and equipment serving in temperate climates.



CP 7021 wears the sand color that the Canadian and U.S. Armies apply to fighting vehicles and equipment serving in arid climates.



CP 7022 will wear the grey, dark red and black color pattern of modern Canadian and American warships.



REGISTER
(free)

[INDEX](#)

[TABLE OF CONTENTS](#)

Athearn will offer the five military tribute models individually as well as in a specially priced five pack.



A traditionally decorated Canadian Pacific SD70ACU included in this release will display

the new monochrome Beaver, blue flag bracket, a center mounted nose door lock and Strathcona's Horse Logo.



Road specific details on a Norfolk Southern SD70ACU will include

front and rear alternate flashing ditch lights, a Nathan 5-chime horn and a large pilot plow.

Features on all Athearn Genesis SD70ACU models include animated roller-bearing trucks, uncoupling levers, flexible MU and trainline hoses, cab interior, LED lighting, tread pattern walkways, windshield wipers, wire grab irons, lift rings, sander lines, Celcon handrails, fuel tank detailed with fuel fillers, fuel gauges, and breather pipes; McHenry knuckle couplers and a 5-pole skew wound motor. Availability of Athearn's Genesis SD70ACU is planned for March 2025.



Athearn has included HO scale GP50 locomotives in six decorating schemes in its March 2025 production schedule. The models

feature either an operating beacon on the cab roof or functioning ditch lights. The GP50 model is based on a prototype road switcher EMD introduced in 1980. It was the first production locomotive to feature EMD's wheelslip control, a system that uses a Doppler radar unit that constantly measures the locomotive's speed and adjusts the power to each axle to minimize wheelslip.

Athearn's GP50 decorated for Santa will have a Leslie RS3L air horn on the cab roof. A nearly identical Burlington Northern unit will have an RS3L horn located in the middle of the main hood.

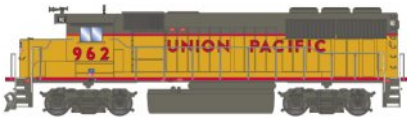

dynamic brakes. A similar Conrail GP50 will differ in that it will have dynamic brakes.

This Union Pacific GP50 is an ex-Missouri Pacific unit that has been equipped with a Leslie RS3L horn and a front plow pilot. It lacks



Additional road names include Central Railroad of Indiana and a BNSF unit with an RV-style AC unit on the cab roof. Features on

all Athearn GP50s in this release include LED lighting, Celcon handrails, formed wire grab irons, and McHenry knuckle couplers. The GP50s will have a speaker installed and a DCC-Ready 21-pin NEM plug.



The 85' flatcar was introduced in the 1960s to accommodate a pair of 40' trailers. They became known as TOFC (Trailer On Flat Car). Athearn has included seven TOFCs in its March 2025 production schedule. Road names will be Santa Fe, Great Northern, Southern Pacific, Soo Line, Florida East Coast and two Trailer Train schemes.

The 85' flatcar was introduced in the 1960s



Features include detailed trailer hitches, wire grab irons, appropriate trucks with 33" machined metal wheels, and McHenry knuckle couplers. A minimum track radius of 22" is required.

Features include detailed trailer hitches, wire grab



A 40' four-bay coal hopper with offset sides is scheduled for release in March 2025. The HO scale model comes with a removable coal load, wire grab irons, and separately applied brake gear including a brake wheel, brake wheel housing, air reservoir, brake cylinder, triple valve and trainline.

A 40' four-bay coal hopper with offset sides is scheduled for release in March 2025. The HO scale model



Decorating schemes will be Santa Fe, Baltimore & Ohio, Canadian National, Canadian Pacific, Illinois

Central and Milwaukee Road. A black car will be available lettered with data only.

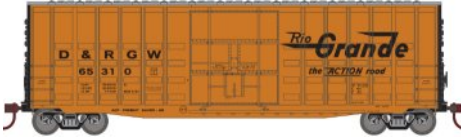

The final HO scale model listed in Athearn's March 2025 production schedule is a 50' waffle-side high-cube boxcar with plug doors. In addition to

Denver & Rio Grande Western, the Roundhouse brand model will be available decorated for Amtrak, Canadian Pacific, Canadian National, Southern Railway and Aberdeen & Rockfish Railway. Most surface detail will be molded into the plastic body.

Info: www.athearn.com



R. Bale

ALP-45DP AND ALP-45A LOCOMOTIVES

The ALP-45DP and newer ALP-45A are dual mode locomotives capable of drawing power from either overhead wires or from its on-board system of diesel engines driving electric generators. The essential difference between the two locomotives is the earlier AL-45DP units were Tier 3 compliant while the newer AL-45A is Tier 4 compliant. Both types were built by Bombardier Transportation in Kassel, Germany. The dual mode locomotives were designed to operate on various diesel-only commuter lines feeding directly into electrified territory that leads to New York City's Penn Station without the need to change motive power. A similar situation exists for EXO in accessing Montreal's Central Station.



To celebrate its 100th anniversary, **Atlas** is offering HO scale NJ Transit ALP-45DP locomotive #4503 in

special artwork to commemorate the occasion.



available decorated for NJ Transit and in the special Atlas 100th Anniversary scheme.



toilet is also available.



Montreal's EXO commuter system.



Operations 40th anniversary scheme (below).



A special 3-pack consisting of an ALP-45DP locomotive, a multi-level cab car and a multi-level trailer is

A similar 3-pack with an ALP-45DP, a trailer and a second trailer with a

ALP-45DP locomotives and multi-level cab car and trailers are available decorated for

An ALP-45DP is also available in NJ Transit's First Responder scheme (above) and in the Rail

A 3-pack with a multi-level cab car and two trailers is available decorated for MBTA (Massachusetts Bay Transportation Authority).

All items listed in 3-packs are also available separately. Availability is planned for late this

year or early 2024. ALP-45DP and ALP-45A DCC locomotives will have a LokSound dual-model decoder. DC versions of the locomotives will come with a speaker and 21-pin connector for an aftermarket decoder.

Info: shop.atlasrr.com



R. Bale

N&W J CLASS 4-8-4 LOCOMOTIVE

The Norfolk & Western Railways class J was a group of fourteen 4-8-4 Northern steam locomotives built from 1941 to 1950 at the railway's shops in Roanoke, Virginia. In the late 1930s, the N&W's 4-8-2 Mountain

locomotives could not handle the rising passenger traffic that developed as the Great Depression abated. The N&W traffic department sought a more powerful and fancy-looking steam locomotive to lead the high profile passenger service between Norfolk and Cincinnati, and between Monroe, Virginia and Bristol, Tennessee. In an effort to give the locomotive smoothness and beauty, along with speed and power, Franklin C. Noel submitted several 4-8-4 proposals before the N&W board settled on the class J bullet-nosed design which incorporated 70" roller bearing drivers and rods. The J's performed flawlessly and continued handling the N&W's flagship passenger service until the summer of 1958 when they were replaced by diesels. The class J 4-8-4s were demoted to local freight service until late 1959 when they were all retired.



Bachmann is preparing to release an HO scale version of the Norfolk & Western's famous class J 4-8-4 steam locomotive. DCC versions of the model will have DCC Sound Value that includes a SoundTraxx steam package with realistic prototypical chuff, short and long whistles, bell, air pump, steam release, and blower—all in 16-bit polyphonic sound.

Info: www.bachmanntrains.com



Bowser has announced a new run of Phase 1 and Phase 3 Alco RS-3 locomotives in HO scale.

Roadnames in Phase 1 are Boston & Maine, Delaware & Hudson, Delaware, Lackawanna & Western; Great Northern, Louisville & Nashville, New Haven, New York Central, Providence & Worcester, Penn Central, Reading, Rock Island, and Southern.

Roadnames in Phase 3 are Interstate Black, Maine Central, and Pennsylvania. The ready to run locomotives include separate air hoses, windshield wipers, grab irons, lift bars, and window glass. The models feature blackened RP25 wheels and knuckle couplers. Each roadname comes in two road numbers, both with either LokSound V5 sound/DCC or a 21-pin DCC plug.



Phase 3 RS-3s come decorated in Interstate Black, Maine Central, and Pennsylvania. The ready to run locomotives include separate air hoses, windshield wipers, grab irons, lift bars, and window glass. The models feature blackened RP25 wheels and knuckle couplers. Each roadname comes in two road numbers, both with either LokSound V5 sound/DCC or a 21-pin DCC plug.

Info: www.bowser-trains.com

Info: www.bowser-trains.com



InterMountain has released Milwaukee Road's unique rib-side boxcars in five paint schemes. One of the most distinctive designs to roll out of Milwaukee Road's own car shop, this boxcar featured horizontal ribbing. Introduced in 1940, many of the distinctive cars continued in service into the late 1970s.



The HO scale ready-to-run models are decorated for Milwaukee Road (Late paint scheme), Milwaukee Road (Modern paint scheme) Route of the Hiawathas (Youngstown doors) and Route of the Hiawathas (original doors).

This production run includes a Milwaukee Road rib-side boxcar modified with roof hatches to handle spent grain from breweries.



InterMountain's version models a car assigned to Miller Brewery.

InterMountain's version models a car assigned to Miller Brewery.



InterMountain is booking reservations for a new production run of HO scale Procor Pressure Flow covered hopper cars.



This release of eight decorating schemes includes four new designs. Four road numbers will be available for Canadian Pacific,

Norfolk Southern, UTLX-Union Tank Car, Canadian National, British Columbia Railway, Halliburton, Procor and Holcim Canada Inc.

All the HO scale models mentioned in this report come with knuckle couplers and appropriate trucks with machined metal wheels.

Info: www.intermountain-railway.com



Kadee has released its 2023 HO scale Christmas car. The ready-to-run model is a PS-1 boxcar with six-panel Superior sliding doors, running boards, full height ladders and Bettendorf-type plain-bearing trucks.

Info: www.kadee.com



Lonesome Valley Lines is selling a kit for an HO scale 40' PS-1 boxcar decorated for the Virginia & Truckee Railroad. This limited edition model is a collaboration between Lonesome Valley Lines

and the Virginia & Truckee Railroad whose authorities approved the color, lettering font and artwork. The model was produced by Accurail.

Info: lonesomevalleylines.com

Rapido Trains has announced plans to produce HO scale versions of EMD's SD7, SD9 and SD10 diesel locomotives. The



SD7 was produced by EMD from mid-1951 through late 1953. The SD9 was released in January 1954 with production continuing until June 1959.

Although similar in appearance to the 1,500hp SD7, a modified 567C prime mover in the new SD9 provided 1,750hp. A spotting feature is the classification lights which point inward on the SD7 and outward on the SD9.

Both SD7s and the SD9s served as the base for rebuilds into the so-called SD10. Many of the earlier units were rebuilt into SD10s by CMStP&P (Milwaukee Road) at its Milwaukee Shops. In addition to the high nose being chopped down with a rounded short-nose cab, the newly minted SD10s were fitted with Horst hooded paper air filters and four-stack exhausts.

Rapido's models will feature numerous road-specific details, separate factory installed grab irons and handrails, operating headlights, rear lights, and white classification lights; beacons (where appropriate), detailed cab interior, correct fuel and water tank arrangements per road name, see-through etched steps, road appropriate cab or nose headlights and Mo-Power capacitor. The models will be available for DC/DCC with sound and for DC without sound.



Road names for the SD7 units will be Bessemer & Lake Erie, EMD Demonstrator 991, Rio Grande (Bumble Bee scheme), Southern Pacific (Orange lettering, Black Widow scheme) and



REGISTER
(free)

[INDEX](#)

[TABLE OF CONTENTS](#)

Southern Pacific (Black Widow). Road names for the SD9s will be Baltimore & Ohio, Burlington Northern, Chicago & North Western (Low nose), and Chicago, Burlington & Quincy (Colorado & Southern sub-lettering).

Chopped nose SD10s will be available for Milwaukee Road, SOO Line (MILW patch) and Dakota Minnesota & Eastern. Note that production of the SD10 is conditional depending on the receipt of sufficient advance reservations to justify the additional tooling. The release date and order deadline are TBA.



An order deadline of February 15, 2024 has been set by

Rapido for a series of prototypically accurate early twin-bay covered hoppers.

In 1948 the New York Central built a group of twin-bay covered hopper cars with a 2,000 cu. ft. capacity. They utilized Standard Railway Equipment's steel roof panels which had four offset roof hatches on each side.



At the same time, the Canadian National built 150 similar cars. Although the NYC and CN cars seem nearly identical, the roof panels, side panels and hatch spacing of the two cars differed slightly. Rapido is preparing accurate versions of both the New

York Central and the Canadian cars. The NYC car will be available decorated for New York Central (Roman), New York Central (Gothic), Texas & New Orleans, Canada Southern, MSGX (FloSweet), GFCX, Penn Central, Penn Central (MOW) and undecorated.



Decorating schemes for the Canadian National car will include CN (As delivered), CN (Noodle), CN (Gray MOW), CN OCS

Sand Service and undecorated. Availability is TBA.



R. Bale

1937 AAR 40' BOXCAR

With more than 94,000 built, the 1937 AAR standard boxcar was one of the most widely utilized freight cars ever produced. Through various secondhand owners, rebuilds and upgrades, many continued in service into the 1980s. At the core of the 1937 AAR boxcar was a 40' 6" long body with a 10' interior height. Ends used on most early cars had a Z shaped inside corner post covered by an end with squared-off corners. Later production featured a W shaped inside corner post which was externally covered by an end with rounded corners. Additional types of ends were also employed, most notably by Canadian railroads which accounted for more than 28,000 of the cars. Roofs also varied with the Murphy raised panel roof being the most common. However, many cars were also built with Viking and flat panel roofs. Other commercially purchased hardware including doors, ladders, running boards, brake wheels and trucks also varied.



Rapido is preparing tooling for an all-new HO scale 1937 AAR 40' boxcar. Rapido is including a variety of parts so that different versions of the car can be accurately produced.



REGISTER
(free)

[INDEX](#)

[TABLE OF CONTENTS](#)

For example, both square and round post ends (with correct sides) as well as Canadian NSC-2 and 5/5 rib ends will be produced. Murphy raised panel, Viking, and flat panel roofs with either wood or photo-etched steel running boards in multiple patterns are also being developed. Access to the roof will be by seven- or eight-rung ladders. Canadian cars will have ladders with integral sill steps. Six-foot Youngstown and Superior sliding doors will be available along with multiple styles of hand brake wheels and housings.



Paint schemes for the initial release will include Canadian National (NSC-2 ends), Canadian Pacific (Spans the World, CP 5/5 ends),

Chesapeake & Ohio, Erie, Lackawanna (Phoebe Snow), Minneapolis & St. Louis, Monon, New Haven, New York Central (Green), Nickel Plate, Seaboard Air Line, Soo Line, Southern Railway, Southern Pacific and Western Pacific. The order deadline and arrival date are TBA.



Additional new HO scale freight cars under development by Rapido include Pennsylvania Railroad H21A and H21E class coal hoppers. Initially designed as a 50-ton coke car, the H21 class

were built between 1909 and 1914. Very quickly it was realized that they would make great coal hoppers. The first cars were converted to H21A class with the addition of 70-ton trucks.



Rapido's new HO scale model will be available in the two most common versions; H21A as rebuilt in the 1930s with a stiffening chord on the top edge of the car side, a power hand brake

and Carmer uncoupling levers; and the 1940s H21E class rebuilds with longer top stiffening chords added and modern underslung cut levers.

Features on Rapido's HO scale versions will include K or AB brake systems as appropriate, heavy die-cast chassis, inside and outside rivet detail, separate wire grab irons, metal knuckle couplers and 70-ton trucks with machined metal wheels.

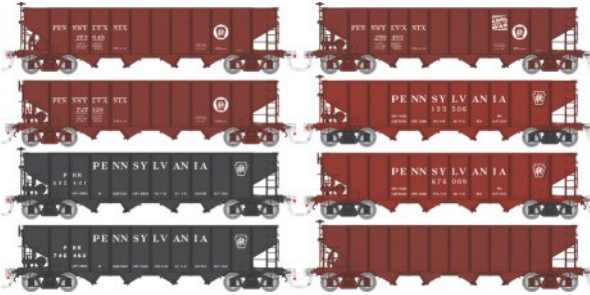

Models of the PRR H21A class cars will be available decorated with a Circle Keystone (K brakes, 1930+), Circle Keystone (AB brakes, 1935+), Circle Keystone

(Coal Goes To War 1941+), Shadow Keystone (1954+), Plain Keystone (Black 1961+) and undecorated. PRR H21E class models will be available with a Circle Keystone (1948+), Shadow Keystone (1954+) and undecorated.

The Order Deadline is March 15, 2024 with delivery TBA.



Rapido has teamed with the Northern Pacific Railway Historical Association to produce an all-new HO scale model of the NP's unique 41' 6" drop bottom gondola. The model is based on

a prototype built by The Pressed Steel Car Company in 1940. The cars were used in general service on the NP including coal and ore and some pulpwood loading. Many were later fitted with extended height sides for use in woodchip and seasonal beet service.

Paint schemes for the initial release will be Northern Pacific (1940), Northern Pacific (1966), Northern Pacific (Pulpwood service), and Burlington Northern (MOW). NP drop bottom

gondolas with extended sides for woodchip service will be available exclusively through the NPRHA. Visit store.nprha.org for details. The final order deadline and delivery schedule are TBA.



In a second joint project with the Northern Pacific Railway Historical Association, Rapido will produce NP Day-Nite coaches in both the Raymond Loewy and Streamline paint schemes. The project covers NP car series 588-599 assigned to the North Coast Limited from initial production by Pullman-Standard in 1946 to the end of the NP.

It is important to note that this is a Conditional Release – meaning this HO scale model will only be produced if the NPRHA and Rapido receive sufficient orders to justify the production investment. Orders placed before January 15, 2024 will receive a 5% pre-order discount.



To ensure prototypical accuracy the HO scale model has been designed from original blueprints augmented by field measurements of preserved cars. The lettering and multi-color interior and exterior paint schemes have been approved by the NPRHA. The truck

and skirt tooling is specific to the three paint schemes which include NP (Streamline scheme), NP (Loewy scheme) and NP/CB&Q (Loewy scheme).

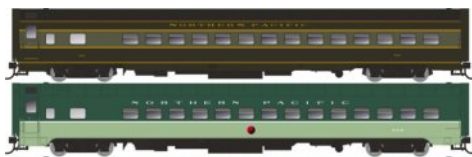

In addition to the regular release road numbers, the Northern Pacific Railway Historical Association also has additional road numbers for each paint scheme available exclusively through the NPRHA store. Visit their website for more information and to reserve: store.nprha.org

As noted above, orders placed before January 15, 2024 will receive a 5% pre-order discount. The final order deadline and delivery are TBA.



Rapido has scheduled another release of its popular Comet commuter cars for the fall of 2024. The HO scale model is based on a prototype built

in the early 1970s by Pullman-Standard as replacements for aging commuter cars the Erie-Lackawanna operated out of New Jersey.

In addition to E-L and New Jersey Transit, subsequent buyers of the Comet car included Boston's Massachusetts Bay Transit Authority (1978), Metro-North and Connecticut DOT (1983), Philadelphia's SEPTA (1987) and Montreal's Agence Métropolitaine de Transport (1989). In 2008 SEPTA and Frontrunner of Salt Lake City obtained some original E-L/NJT Comet cars, and in 2008 LA's Metrolink leased the Frontrunner cars for three years.



The original Comet cars built for the E-L were designed for low platforms, but upgrades to the car design by Pullman-Standard (and later Bombardier) evolved the Comet design to support both high- and low-platform boarding. They also evolved with feature amenities such as on-board washrooms, accessible seating and, after 1990, a wide center door for high-platform boarding.

Features of Rapido's HO scale Comet cars include full interior and underbody details, tinted windows, accurate painting and lettering, and all-wheel electrical pickup with flicker-free lighting. Interior lighting and end markers are controllable with a magnetic wand.

Paint schemes available in this release will be Montreal AMT (Late scheme), Connecticut DOT (As delivered), Connecticut DOT (Late scheme), MARC, New York Metro North, New York Metro North (West of Hudson scheme), Boston MBTA, Philadelphia SEPTA and unlettered. The order deadline is February 15, 2024 with delivery expected in the fall of 2024.

Info: www.rapidotrains.com



Scale Trains has released kits for an HO scale steel caboose. The model is based on a Santa Fe prototype.



The new model is from Scale Trains Kit Classics line, which requires a Phillips screwdriver and glue to assemble.



The kits come with appropriate trucks with 33" machined metal wheels and plastic Type E knuckle couplers.



Available road names include Santa Fe, Burlington Northern, Canadian Pacific, Denver & Rio Grande Western, Milwaukee Road, Missouri Pacific, Southern Pacific and Chicago, Burlington & Quincy.

Info: www.scaletrains.com

DISCLAIMER

The opinions expressed in this column are those of the writer and do not necessarily reflect the opinion of Model Railroad Hobbyist or its sponsors. Every effort is made to provide our readers with accurate and responsible news and information, however, neither Model Railroad Hobbyist or the writer of this column can be held responsible for any inaccuracies or typographical errors that may inadvertently appear in this column.



R. Bale

SOUTHERN PACIFIC YELLOW STRIPE BOXCARS

In the early 1960s, SP faced a boxcar shortage from one of its most important customer constituencies: online lumber shippers. In addition to needing the availability of more cars, the lumber trade wanted cars with wider doors to ease the loading process. In 1963, Southern Pacific's Sacramento Shops embarked on an ambitious program to rebuild existing 40-foot boxcars with 7' doors to cars to larger 10' door openings. The rebuilt boxcars were distinctive due to the combination of their 10' height, 10' sliding Youngstown door, and the 7" reinforced sill added below the door. The rebuilding project continued until 1970, and by the end of the program Sacramento Shops had amassed a fleet of more than 7,000 rebuilt cars. To denote lumber loading only, a yellow stripe was painted diagonally across on the doors of the rebuilt cars.



version replicates the cars from the 1963-1966 rebuild program, which had the original ends, Apex running boards and brake step, full height 8-rung ladders and brake appliances including an Equipco brake wheel, all in their original 1950s location.



The second version replicates the cars rebuilt after 1967 with the running board removed, ladders and brake appliances lowered, and replacement Dreadnaught ends installed. Underbody details also varied from the original as-built cars. Each version is available in 12 different road numbers. Both versions come with Kadee couplers and 50-ton ASF A-3 Ride Control trucks with machined metal wheels.

Tangent Scale Models has released two HO scale versions of the Southern Pacific's yellow stripe Sacramento Shops rebuilt 40' boxcar with 10' doors. The first



REGISTER
(free)

[INDEX](#)

[TABLE OF CONTENTS](#)

A fully assembled 1965+ model is available painted but unlettered except for the yellow stripe. Undecorated kits are available for both the 1965+ and 1968+ rebuilds.

Info: www.tangentscalemodels.com

ICG Decals has released a quality water slide for the undecorated version of this Tangent model. See the Decal section at the end of this report for details.



New products coming from **Walthers** next spring include a Proto series EMD high hood GP9. The HO scale model

will be available with LokSound 5 Sound & DCC as well as standard DCC with a 21 pin connector for installation of an aftermarket decoder.

Boston & Maine GP9s will represent Phase II units with dynamic brakes, 36" radiator fans, winterization hatch and a whip antenna.



Grand Trunk Western GP9s in this release are also Phase II units that are setup for operation with the long hood

forward. They will have a winterization hatch, Sinclair antenna and a Peacock brake wheel. All other GP9s in this release will have a lever type ratchet hand brake.



GP9s decorated for Milwaukee Road represent Phase III units with dynamic brakes, winterization hatch and a Leslie S-2M air horn.



Illinois Central GP9s are also Phase III production. They have a Nathan P3 air horn.



Walthers GP9s decorated for Norfolk & Western are Phase II units with dynamic brakes, a whip antenna, and a Leslie RS-5t-R air horn.



Completing this release are Phase III GP9s decorated for Pennsylvania Railroad. Like the prototype, the

models will be configured for operation with the long hood forward. Details include dynamic brakes, a Sinclair antenna and a Leslie RS-3L air horn. All of Walthers GP9s in this release will have Pyle sealed beam headlights, 1,600 gallon fuel tanks, Blomberg B trucks, wire grab irons, and photo-etched lift rings. Units with dynamic brakes will have 48" fans.



Walthers has scheduled another release of its Trinity 30,145 gallon tank car. Four road numbers each will be available for TILX-Global Ethanol, GATX-General

American Marks Company, CGTX-Canadian General Transit, NATX-North American Tank Car Line, NATX-Renewable Products, TILX-Trinity Industries Leasing, VMSX-Valero Marketing & Supply and ADMX-Archer-Daniels-Midland.



The HO scale Proto series model features see-through etched metal walkways and end platforms, and



appropriate roller-bearing trucks with 36" machined metal wheels. Availability is planned for winter 2024.



Also coming from Walthers next winter is a Mainline series 59' cylindrical covered hopper with four discharge bays. The HO scale model is

based on a 4,550 cu. ft. prototype introduced by National Steel Car in 1972. Cars with four round loading hatches will be available for UNPX-Alcan, PTEX- Canpotex Limited, and two Canadian National schemes.



Models with trough hatches will be available decorated for Canadian Pacific, FCP- Ferrocarriles del Pacifico, HONX-Honeymead and BNSF.



Also coming from Walthers next spring is an ACF 50' boxcar with exterior posts and Youngstown sliding doors. Plate B

dimensions of the HO scale Mainline series model include a 10' 8" width and a height of 15' 2" above the rail head.



Four numbers each will be available for Railbox, Terminal Railway Alabama State Docks, Kansas City Southern,

Mississippi Export Railroad, New Orleans Public Belt, Virginia & Maryland, and Bangor & Aroostook. An undecorated model will be included in this release. All Walthers models mentioned in this report come with Proto MAX metal knuckle couplers.

Info: www.walthers.com

N SCALE PRODUCT NEWS



Athearn has announced the future production of an N scale 53' GSC flatcar both with and without bulkheads. The models will be released in March 2025.

Models with bulkheads will be available for Norfolk Southern, Great Northern, Missouri Pacific, Frisco, and Chicago Burlington & Quincy.



GSC flatcars decorated for BNSF and Trailer Train will not have bulkheads. Both versions will feature a separately applied brake wheel, body mounted McHenry knuckle couplers and screw mounted 50-ton Bettendorf plain-bearing or 70-ton roller-bearing trucks with 33" wheels.

Info: www.athearn.com



To celebrate its 100th anniversary, **Atlas** is offering an N scale NJ Transit ALP-45DP locomotive #4503 in special artwork to commemorate the occasion.



A special 3-pack consisting of an ALP-45DP locomotive, a multi-level cab car and a multi-level trailer is available

decorated for NJ Transit and in the special Atlas 100th Anniversary scheme.



REGISTER
(free)

[INDEX](#)

[TABLE OF CONTENTS](#)



A similar 3-pack with an ALP-45DP, a trailer and a second trailer with a toilet is also available.



ALP-45DP locomotives and multi-level cab car and trailers are available decorated for Montreal's EXO commuter system.



An ALP-45DP is also available in NJ Transit's First Responder scheme (above) and in the Rail Operations 40th anniversary scheme (below).



A 3-pack with a multi-level cab car and two trailers is available decorated

for MBTA (Massachusetts Bay Transportation Authority).

All items listed in 3-packs are also available separately. Availability is planned for late this year or early 2024. ALP-45DP and ALP-45A DCC locomotives will have a LokSound dual-model decoder. DC versions of the locomotives will come with a speaker and Next18 socket for an aftermarket decoder. Info: shop.atlasrr.com

Bluford Shops is booking preorders through the end of January for a new N scale 14 panel triple-bay coal hopper car. The



design of the model is based on a 1950s prototype the New York Central developed as an alternative to the basic AAR 70-ton rib side hopper.

Decorating schemes in this release will include Delaware & Hudson and Western Maryland which are based on prototypes built by Bethlehem Steel in 1958.



Models decorated for Erie Lackawanna and Florida East Coast (both built by Greenville in 1965), and Santa Fe (built by Greenville in 1967) are included in this release.



Additional schemes acquired through merger include Penn Central, Louisville & Nashville, Canada Southern, and

Clinchfield. Bluford's N scale hoppers feature a diecast slope sheet/hopper bay assembly, a removable load, metal wheels, and magnetically operating knuckle couplers.

Info: bluford-shops.com



Now available from **Eastern Seaboard Models** is a new run of N scale Class G26 mill

gondolas, in three variations. The G26 has two large ribs, the G26A has an additional center rib, and the G26C has large ribs across the fishbelly section. The Norfolk & Western G3 gondola is the same body style as the G26A.



Roadnames for the G26 are Pennsylvania (circle keystone) and Lehigh Valley,

the G26A/G3 Pennsylvania in circle keystone and shadow



REGISTER
(free)

[INDEX](#)

[TABLE OF CONTENTS](#)

keystone, Norfolk & Western (early & late), and Penn Central. Finally, the G26C will be in Pennsylvania (plain keystone) and Penn Central. The 2023 Holiday Car is a G26 gondola decorated for Pennsylvania with metallic red iron oxide paint, and metallic silver and gold printing.



Models will feature either an Ajax brakewheel or ratchet hand brake, Micro-

Trains Dalman or National B-1 truck frame with machined metal wheelsets, and Micro-Trains #1015 knuckle couplers. Due to the length of the model and the body mounted couplers, the models require at least 12.5" radius curves.



Also announced is an upcoming third release of a N scale GSC well car. Most of the road names in this release are the same as in previous releases, but ESMC has indicated that there will be "representative" paint schemes for railroads that may have owned well cars, but not this particular model. Canadian Pacific will be one of these. New trucks with 28" machined wheels are being tooled for this release.



Four new 3D-printed loads that are sized for the GSC well car will be available by the Amherst Railroad Hobby Show in late January 2024. They are a "Double Rings" load, "Owl Eyes," load,

"Red Turbine" load (pictured), and a "Big Dish" load.

Info: www.esmc.com

Jacksonville Terminal Company has released new multi-packs of N scale 53' high cube 8-55-8 containers. Both Schneider and JB Hunt containers are available in six and three packs. All of the containers include JTC's magnetic stacking



system. The Schneider 6-pack contains a special 30-year anniversary container.

Info: jtcmodeltrains.com

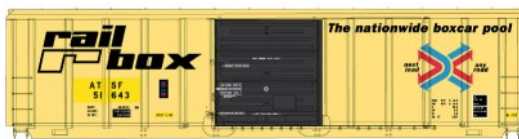

InterMountain has released an N scale 5,277 cu. ft. boxcar with exterior posts in seven paint schemes, four of which are new.



Models decorated for Canadian National, Burlington Northern, CSX, Santa Fe (ex-Railbox) and Rock Island will have Pullman-Standard sliding doors. Cars decorated for Southern Railway and Montana Rail Link will have six-panel Superior sliding doors. The N scale models have roller-bearing trucks with metal wheels and knuckle couplers.

Info: www.intermountain-railway.com



RailSmith has announced that the Kansas City Southern “Southern Belle” will be the next N scale train to be introduced. The first two coaches are available to order now and both E and F units in N scale are planned for this train, which will also include a baggage RPO car, a diner car, two sleepers, and a

lounge observation car.

Also announced is a pair of N scale Great Northern coaches. Built by Pullman-Standard in 1950, the prototype of these



REGISTER
(free)

INDEX

TABLE OF CONTENTS



coaches was known as a Day-Nite Coach, providing the 48 passengers it held with greater leg room. These

models replicate the cars after their skirts were removed, exposing the undercar appliances to view. The cars are appropriate for use on the Badger, the Gopher, the International, the Western Star, and the Portland to Seattle pool trains.

Info: lowellsmith.net



R. Bale

EMD SD40-2 DIESEL LOCOMOTIVE

The SD40-2 is a 3,000hp diesel electric locomotive built by Electro Motive Division of General Motors from 1972 to 1989. The SD40-2 was introduced as part of EMD's Dash 2 series, competing directly against the GE's U30C and the Alco Century 630. Although higher-horsepower locomotives were available, the reliability and versatility of the SD40-2 made it one of the best-selling models in EMD's history. While the sixteen-cylinder 645E3 turbocharged prime mover remained the same as its predecessor SD40, the SD40-2 boasted a solid-state electrical system that featured replaceable modules rather than troublesome relays resulting in greatly simplified electrical troubleshooting and repairs. Sales of the SD40-2 began to diminish after 1981 due to the oil crisis, increased competition from GE's Dash 7 series and the introduction of the EMD SD50. Many SD40-2s remain in service today, both with original owners as well as secondhand operators.





ScaleTrains is scheduled to release an N scale model of EMD's popular SD40-2 this month. Features on the Rivet Counter SD40-2 include 3-hose MU clusters with silver

gladhands, treadplate walkways, detailed cab interior, LED lighting, uncoupling levers, detailed intake grilles, 4,000 gallon fuel tanks and HTC trucks.



A CSX version of the model will have a short 88" hood, a CSX-style anti climber and front and rear operating ditch lights. An SD40-2 decorated for Union Pacific will have a non-operating strobe light, a tall front pilot plow and a bell mounted under the locomotive frame.



Southern Railway SD40-2s will have a high 81" hood with a wheel hand brake, tall plows in both the front and rear and a Nathan P5A horn. They will be configured for operation with

the long hood forward. ScaleTrains will offer the Southern unit in both gold and Dulux lettering.



Features on Chessie models include a Nathan K5LA air horn, a whip antenna and Chessie-style rock pilots in both the front and rear of the locomotive.



SD40-2s decorated for Burlington Northern will have a low 88" nose hood, an EMD pilot plow at the front and a non-operating FedSig 372 beacon.



REGISTER
(free)

[INDEX](#)

[TABLE OF CONTENTS](#)

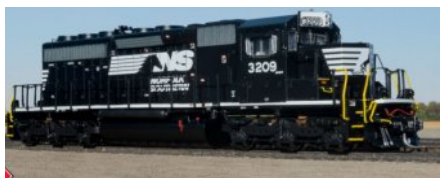

Completing this release of Rivet Counter SD40-2 locomotives is an NS unit with operating front and rear ditch lights, a low EMD front pilot plow and a Nathan P5A horn. Locomotives equipped for DCC and sound will have a cube speaker and an ESU LokSound 5 decoder.

Scale Trains has announced the availability of a group of N scale Trinity RD-4 coal hopper cars.

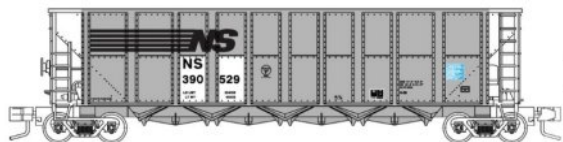

Using tooling originated by Fox Valley, the model replicates the prototype 4,200 cu. ft. modern aluminum coal hauler introduced by Trinity in the mid-1990s.

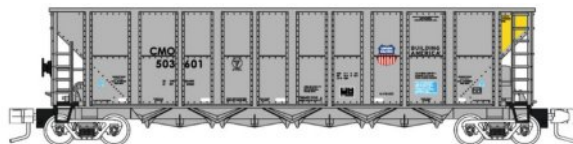

The N scale model features a die cast weight with interior detail, removable coal load, 36" machined metal wheels, and body mounted M-T compatible knuckle couplers.



Multiple road numbers are available for Union Pacific, TILX-Trinity Leasing, Norfolk Southern BNSF and Chicago & North Western.



Info: www.scaletrains.com

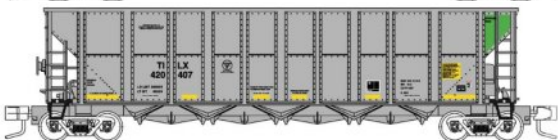

NEW STRUCTURES & SCENIC SUPPLIES



Athearn plans to release a 28' drop frame parcel trailer in the first quarter of 2025. The HO scale

model will be available decorated for UPS (United Parcel Service of America) and Roadway Package System.



Also coming in early 2025 is an N scale 28' wedge trailer. They will be available in pairs with a dolly. Decorating schemes will be Consolidated Freight, Preston and PIE.

Info: www.athearn.com



The newest HO scale structure laser-cut kit from **Berkshire Valley Models** is this elaborate Corner Drug Store (Item 2038). In addition to laser-cut wood

components the kit includes a large selection of white metal detail parts, signage, and an attractive scalloped roof. The model is designed to allow for detailing the interior using BVM interior kit (Item 2039) which is available as a separate purchase. The assembled kit has a footprint of 5.5" x 4".

Info: berkshiredesign.net



Frenchman River Model Works has introduced an HO scale craftsman kit for Spade Hardware, an aging two-story brick/stucco structure that has seen better days. The distinctive storefront panels can be assembled in two different ways.



REGISTER
(free)

[INDEX](#)

[TABLE OF CONTENTS](#)



The kit consists of cast resin walls, storefront panels, and details; window glazing material, signage and decals, roofing material, a Tichy fire escape kit, and assembly

instructions. The finished structure has a footprint of 2.5" wide by 3.75" deep. Assembly and painting are required.

Info: www.frenchmanriver.com



New items from **Monster Models** include engine house doors for both standard and narrow gauge in HO, S and O scales. The doors include hinges and are available with or without

windows. They are detailed on both sides. Assembly and painting are required.

Info: www.larkspurlaserart.com



New 1:87th scale vehicles from **Oxford Diecast** include a 1958

Edsel Citation coupe. The model features Silver Gray paint with Ember Red roof and body highlights, wide white wall tires and a continental spare mounted on the trunk. Also new from Oxford is a 1959 Plymouth Savoy sedan painted and decorated as an Oklahoma Highway Patrol cruiser.

Info: www.walthers.com



New HO scale cast resin scenic details from **Rusty Rail** include a 1934 Ford pickup abandoned in a pile of junk, a

1940 Ford Woody station wagon, and a 1947 Dodge Power Wagon. Painting and minor assembly are required.



New O scale details include a set of six roof vents. The assortment includes four cyclone vents in different sizes and two square vents.

Info: www.rustyrail.com

NEW DECALS, SIGNS AND FINISHING PRODUCTS



ICG Decals has released a new HO scale water slide decal for a Southern Pacific boxcar rebuilt

with 10' doors (Item SE27). Daniel Kohlberg developed this decal set specifically for the undecorated version of the new Tangent Yellow Stripe boxcar. The set, which will letter two cars, includes extra CAPY data, reweigh dates and locations.

Info: www.icgdecals.com

National Scale Car has released ten new HO scale water-slide decal sets. Cartograf of Italy printed the high-quality decals. Items available now include:



Shell tank cars (Item D245).



Texas & Pacific 42' flatcars (Item D246)



REGISTER
(free)

[INDEX](#)

[TABLE OF CONTENTS](#)



Oscar Mayer OMX reefers (Item D247).



Savanna & Atlantic rebuilt boxcars (Item D248).



Florida East Coast rebuilt boxcars (Item D249).



Rutland 40' flatcars (Item D250).



NYC System raised roof, rebuilt boxcars, and auto cars (Item D251).



Southern Pacific B-50-12a boxcars (Item D252).



Spokane Portland & Seattle 40' flatcars (Item D254).



Great Northern 50' rebuilt single-sheathed and PS-1 end boxcars and auto cars (Item D255).

Info: nationalscalecar.com

Get more articles like this

GIVE IT A LIKE





BRIEFLY NOTED AT PRESS TIME ...

Archer Transfer, closed since the fall of 2022, plans to reopen as soon as a new website is completed...

New items coming from **Atlas O** during the second quarter of next year include SD45 and F40PH locomotives, bi-level gallery cars, 3-bay Center flow and PS 4750 covered hoppers, 50' hi-cube boxcars, coil steel cars, Multi-Max auto carriers and a bay-window caboose. Dealer reservations close December 6, 2023 ...

Although distribution of **Broadway Limited Imports** HO scale GS-4 No. 4449 was originally limited to Factory Direct Hobbies, the specially decorated black and silver HO scale steam locomotive will now be available from all authorized BLI dealers ...

InterMountain plans to release an N scale R-70-20 refrigerator car in eight paint schemes this month. Also new is an HO scale X-29 boxcars with new road numbers for eight previously released roads, plus an all new X-29 decorated for Ferrocarril Chihuahua al Pacifico. Reservations are being accepted through December 31, 2023 for an HO scale 4785 cu. ft. PS2-CD covered hopper with correct hatch and discharge gate combinations for each of 11 paint schemes. Availability is TBA...

New HO scale Proto models coming from **Walthers** next summer include an all-new 89' Greenbrier TTX 110-ton flatcar followed later in 2024 by a Thrall 53' 15-panel steel gondola and a Santa Fe wood waycar in three 1300-series decorating schemes. Walthers Mainline models due in 2024 include a Trinity 25,000 gallon tank car and an 89' flatcar with a shielded tri-level auto rack. A Cornerstone kit is being developed for a mid-century brick and concrete freight station based on a rail facility in Lenoir, North Carolina ... ■

Get more articles like this



[REGISTER](#)
(free)

[INDEX](#)

[TABLE OF CONTENTS](#)

SELECTED EVENTS



Model Railroad Hobbyist | November 2023

NOVEMBER

Please check with any organization hosting an in-person event for the latest status of the event.

Ongoing 2023

ONLINE, Zoom, dates vary, see website. Operation Special Interest Group Meetups – limited attendance available.

Info: www.opsig.org/Virtual

Archive: www.opsig.org/Virtual/Past

ONLINE, Zoom & YouTube, Wednesday & Saturday, see Facebook page. “New Tracks” Meetup, hosted by Jim Kellow, MMR.

Info: newtracksmodeling.com

YouTube: www.youtube.com/channel/UCMA_VhPb5pjdkAYTdXLceJA

ONLINE, Facebook & YouTube, dates vary, see Facebook page. “NMRAX” organized by Gordy Robinson, Martyn Jenkins, Gert Muller, Jordan Kramer.

Info: www.facebook.com/groups/nmragroup

ONLINE, YouTube, every other Saturday. 4th Division, Pacific Northwest Region, NMRA hosts online layout tours and clinics.

Archive: www.youtube.com/c/4DPNRMovies

ONLINE, Zoom, Second Tuesdays, 8pm Eastern. "Off the Beaten Track" featuring Narrow Gauge layouts, clinics, and manufacturers.
Info: groups.io/g/NNG

AROUND THE USA, IN-PERSON, Various dates. ScaleTrains.com Road Trip.
Info: www.scaletrains.com/roadtrip

November-December 2023

CALIFORNIA, ANAHEIM, December 15-16, 2023. Super Meet 2023, sponsored by the Toy Train Operating Society – Southern Pacific Division. Brookhurst Community Center, 221 W. Crescent Ave.
Info: ttos-sp.org/thesupermeet

CALIFORNIA, CROCKETT, December 9-10, 2023. Carquinez Model Railroad Society Open House. 645 Loring Avenue.
Info: cmrstrainclub.org

CALIFORNIA, TULARE, November 18-19, 2023. California Special Train, Toy, and Model Kit Show. International Agri-Center, 4500 S. Laspina St.
Info: www.eventcreate.com/e/tularetrainshow

COLORADO, LONGMONT, December 8-10, 2023. Boulder Model Railroad Club Annual Model Railroad Expo. Boulder County Fairgrounds Exhibit Hall, 9595 Nelson Rd.
Info: www.bmrconline.org

COLORADO, LOVELAND, November 25-26, 2023. Rocky Mountain Train Show – Holiday 2023. The Ranch Events Complex, 5280 Arena Circle.
Info: rockymountaintrainshow.com/Default.aspx

INDIANA, DANVILLE, November 18, 2023. 16th annual Danville Indiana Train Show. Hendricks County Fairgrounds, Old US 36 (E Main St), 12 miles west of I-465
Info: www.cidnmra.org/services



REGISTER
(free)

[INDEX](#)

[TABLE OF CONTENTS](#)

MICHIGAN, SALINE, November 26, 2023. Rails on Wheels 2023 Train Show. Washtenaw Farm Council Grounds, 5055 Ann Arbor-Saline Road.

Info: railsonwheels.com

MICHIGAN, SHELBY TOWNSHIP, November 25, 2023. Model Train Show at the Packard Proving Grounds. Packard Proving Grounds Historic Site, 49965 Van Dyke Ave.

Info: packardprovinggrounds.org/event/trainshow

NEW YORK, ALBANY, December 3, 2023. Great Train Extravaganza, sponsored by the Hudson-Berkshire Division of the NMRA. Underneath The Egg, Empire State Convention Center.

Info: gtealbany.com

NEW YORK, HAMBURG, November 18-19, 2023, February 17-18, 2024. WNYRHS Train & Toy Show, sponsored by the Western New York Railway Historical Society. Fairgrounds Event Center, 5820 South Park Ave.

Info: wnyrhs.com

OHIO, LIMA, December 9 (or 16), 2023. Train Town Train Show & Swap Meet. Allen County Fairgrounds, 2750 Harding Highway.

Info: div3.ncrnmra.org/lima-show-and-swap-meet

OHIO, MARION, December 2, 2023. 37th Annual Model Train Show. 220 E Fairgrounds Rd.

Info: mariontrainshow@outlook.com

OREGON, PORTLAND, November 18-19, 25-26, December 2-3, 2023. 2023 Open House at the Columbia Gorge Model Railroad Club. 2505 North Vancouver Ave.

Info: cgmrc.com/events

OREGON, RICKREALL, December 2, 2023. Willamette Valley Model Railroad Show and Sale. Polk County Fairgrounds & Event Center, 502 S. Pacific Highway West.

Info: www.co.polk.or.us/fair/railroad-show-6

VIRGINIA, FREDERICKSBURG, December 9-10, 2023. Rappahannock Model Railroaders' 26th Annual Christmas Model Train Show. Fraternal Order of Eagles Lodge #4123, 21 Cool Spring Road.
Info: www.rmrailroaders.com

WASHINGTON, TACOMA, December 22, 2023 – January 1, 2024. The 27th Annual Model Train Festival. Washington State History Museum, 1911 Pacific Avenue.
Info: www.washingtonhistory.org/exhibit/trainfestival-27

Future 2024 by location

ONLINE, YouTube, March 18-21, NERx, the annual Northeastern Region, NMRA Virtual Convention.
Info: nerx.org and www.youtube.com/c/NMRAORGModelRailroading

ALABAMA, MOBILE, March 2-3, 2024. 2024 SWARM Model Train Show. Mobile Via Health, Fitness and Enrichment Center, Arlene F. Mitchell Campus, 171 Dauphin Street.
Info: Gasamuel@aol.com

ARIZONA, MESA, May 2-4, 2024. 2024 Sn3 Symposium. Sheraton Mesa Hotel at Wrigleyville West, 860 North Riverview.
Info: sn3symposium.com

CALIFORNIA, LONG BEACH, August 4-11, 2024. Surfliner 2024 NMRA National Convention. Westin Long Beach, 333 East Ocean Blvd.
Info: surfliner2024.org

COLORADO, DENVER, April 6-7, 2024. Rocky Mountain Train Show – Spring 2024. National Western Complex, 4655 Humboldt St.
Info: rockymountaintrainshow.com/Default.aspx

KANSAS, LAWRENCE, March 2-3, 2024. Lawrence Train Show, sponsored by the Lawrence Model Railroad Club. Crown Toyota Used Car Kingdom, 3400 S. Iowa St.
Info: lawrencemodelrailroadclub.org/TrainShow24.png



ILLINOIS, MACHESNEY PARK, March 16-17, 2024. Rock River Valley Train Show. Harlem High School, 9229 N. Alpine Rd.
info: www.rrvd-nmra.com

MASSACHUSETTS, WEST SPRINGFIELD, January 27-28, 2024. Amherst Railway Society Railway Hobby Show. The Eastern States Exposition Fairgrounds, 1305 Memorial Avenue.
Info: www.railroadhobbyshow.com

MARYLAND, TIMONIUM, February 3-4, 2024. Great Scale Model Train and Railroad Collectors Show & Railroad Marketplace. Maryland State Fair, 2200 York Rd.
Info: www.gsmts.com

NEW JERSEY, SEWELL, January 20-21, 2024. Railroad Days at the Margaret E. Hegan Library, sponsored by the New Jersey Southern Model Railroad Club. 606 Delsea Dr.
Info: rick773@hotmail.com

NEW YORK, HAMBURG, November 18-19, 2023, February 17-18, 2024. WNYRHS Train & Toy Show, sponsored by the Western New York Railway Historical Society. Fairgrounds Event Center, 5820 South Park Ave.
Info: wnyrhs.com

PENNSYLVANIA, PITTSBURGH, September 11-14, 2024. 44th National Narrow Gauge Convention. Doubletree by Hilton Hotel Pittsburgh – Green Tree, 500 Mansfield Avenue.
Info: www.44nngc.com

SOUTH CAROLINA, EASLEY, February 16-17, 2024. Central Railway Museum's Model Train Expo 2024. Rock Springs Church – Impact Center, 207 Rock Springs Road.
Info: www.crmha.org/trainshow

TEXAS, PASADENA (Houston), February 17, 2024. 2024 Greater Houston Train Show, sponsored by the San Jacinto Model Railroad Club Inc. Pasadena Convention Center, 7902 Fairmont Parkway.
Info: sanjacmodeltrains.org

WISCONSIN, MADISON, February 17-18, 2024. 56th Annual Mad City Model Railroad Show and Sale. Exhibition Hall, Alliant Energy Center, 1919 Alliant Energy Center Way.

Info: www.nmra-scwd.org

WISCONSIN, STEVENS POINT, January 20-21, 2024. Central Wisconsin Model Railroaders, Ltd 26th Annual Arctic Run Model Railroad Show & Sale. Holiday Inn Convention Center Hotel, 1001 Amber Avenue.

Info: cwmr_mnw@yahoo.com ■

Get more articles like this

GIVE IT A LIKE



Did you see this article?

in the **NOVEMBER 2023 MRH RUNNING EXTRA!**



Scratchbuild common fleet parts

Get full eBook now ▶

← click
here



Each eBook has 80-100 pages

RUNNING EXTRA



REGISTER
(free)

[INDEX](#)

[TABLE OF CONTENTS](#)

Make it run like a

Dream TRACKWORK BOOK

104 pages

By Joe Fugate

AUTUMN
SPECIAL

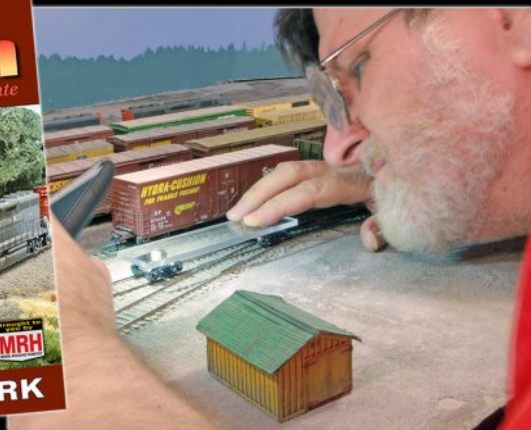
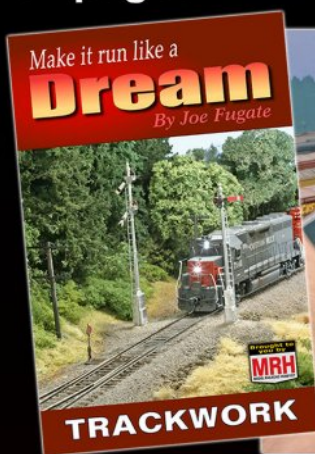

Available from the MRH Store: store.mrhmag.com

"The new bible of track laying." - L.T.

"Chapter 3 alone is worth the cover price." - B.M.

"A lot of info ... copiously illustrated.." - J.A.

Click me to

Get eBook NOW >>

~~\$14.99~~ \$9.49

Format: Landscape and Portrait
PDF

Click me to

ORDER PAPERBACK >>

~~\$31.99~~ \$27.99

FREE shipping in US!
Foreign shipping 50%

Other books in this series: ROLLING STOCK (available now) and LOCOS (mid 2024)

MRHMAG.COM

[INDEX](#)

[TABLE OF CONTENTS](#)

Windy City



Classics

F40PHM-2 LOCOMOTIVE



3D CAD renders and art are subject to revision before final production.

HEP E9 LOCOMOTIVES



Photo by Bruce C. Nelson. Courtesy of the Kevin E. Daily collection.

CLICK HERE!



Quality. Style. Spirit.™

rapidotrains.com • [youtube.com/RapidoTrains](https://www.youtube.com/RapidoTrains) • [facebook.com/RapidoTrains](https://www.facebook.com/RapidoTrains)

RAPIDO



REGISTER
(free)

[INDEX](#)

[TABLE OF CONTENTS](#)

CLICKABLE ADVERTISER INDEX

[Accu-Lites](#)
[Affordable Model Railroads](#)
[Amherst Railway Society](#)
[Atlas Model Railroad Co.](#)
[Bachmann](#)
[Berrett Hill Trains](#)
[Black Cat Publishing](#)
[Blair Line](#)
[Coffman Graphics](#)
[Crew Call with Mike Rose](#)
[Crow River Products](#)
[Digitrax \(2 page spread\)](#)
[East Coast Circuits](#)
[ESU LokSound](#)
[Fast Tracks](#)
[Great Decals](#)
[Inter-Action Hobbies](#)
[Iowa Scaled Engineering](#)
[ITLA Scale Model Inc.](#)
[Litchfield Station](#)
[LocoFi](#)
[Logic Rail Technologies](#)
[Micro-Trains Line](#)
[miniprints](#)
[Model Railroad Control System](#)
[Model Rectifier Corporation](#)
[Monashee Laser Engineering](#)
[Monroe Models](#)
[MRH Store \(1\)](#)
[MRH Store \(2\)](#)
[MRH Store \(3\)](#)
[MRH Store \(4\)](#)
[Mt. Albert Scale Lumber](#)
[NCE \(2 page spread\)](#)
[North American Railcars \(PWRS\)](#)
[The N-Scale Division](#)
[Pre-Size Model Specialities](#)
[Precision Design Co.](#)
[Proto87.com](#)

[Rapido \(1\)](#)
[Rapido \(2\)](#)
[Ring Engineering](#)
[Rock Island Hobby](#)
[Roomettes](#)
[Scale Trains](#)
[Sceniking.com](#)
[Scott Antique Markets](#)
[SiskiyouLine.com](#)
[SoundTraxx](#)
[Southern Digital](#)
[Squeaky's Trains](#)
[Streamlined Backshop](#)
[TAM Valley Depot](#)
[TrainMasters TV](#)
[Walthers](#)
[Westerfield](#)

Did you see this article?

in the **NOVEMBER 2023 MRH RUNNING EXTRA!**



Build an animated lift bridge

Get full eBook now ▶

click here

MRH **RUNNING**
EXTRA

Each eBook has 80-100 pages

Clickable "other" index
[Other – Contents](#)
[Other – Cover](#)
[Other – MRH Marketplace](#)
[Other – MRH Sponsors](#)

Coming next month in MRH ...

Thom Driggers details an undec'd bulkhead flat ...

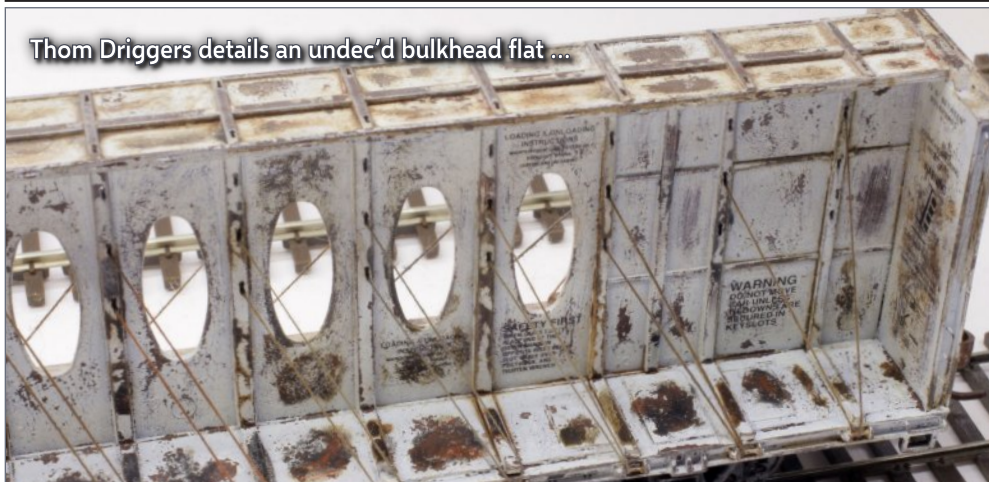

Solving intermittent brass loco power pickup issues ...



Making resin cast log bunks ...



... coming December 15th in the
December MRH

HAVING FUN WITH TRAINS
DECEMBER 2023 | FREE

MRH

MODEL RAILROAD HOBBYIST

Thom Driggers steps through ...
Finishing an undec'd bulkhead flat
BEFORE **▶ READ NOW**

ADAPTIVE EDITION TABLE OF CONTENTS



REGISTER
(free)

[INDEX](#)

[TABLE OF CONTENTS](#)

Coming next month in Running Extra ...

... all the MRH articles and ads, PLUS:

Charles Hepperle details and finishes a brass steamer ...



3rd Street Industrial district TOMA module ...

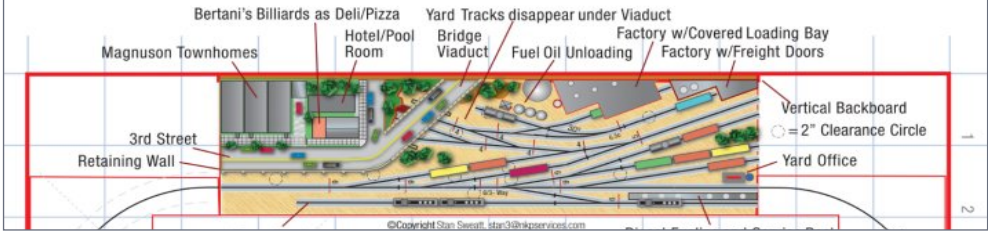

December 2023 - \$2.99

MRH RUNNING
EXTRA
Apprentice with savvy modelers

Charles Hepperle's process used to ...
Detail/finish a Santa Fe steamer
▶ **READ NOW**

◀ **BEFORE**

Also these articles:

- Lorem ipsum dolor sit amet
- Consectetur adipisicing elit morbi
- Vestibulum tempus vehicula
- Mauris tempor libero ipsum pellentesque
- Nullam porta ut arcu at lobortis

... and much more!

MRH looks at new & improved
HO and N flex track ...

... all this and much more!

SUBSCRIBE AND SAVE UP TO 80%