

HAVING FUN WITH TRAINS

JULY 2023 | FREE

# MRH

MODEL RAILROAD HOBBYIST

ALSO:

- Build an HOn3 layout: 2
- DCC car lighting circuit
- Control panel design tips
- ESU LokSound diesel install
- ... *and more inside!*

## Mike Armstrong's Rock Island

▶ READ NOW



ADAPTIVE EDITION  
*Landscape or Portrait depending on screen size*



DOWNLOAD

TABLE OF CONTENTS

# This is the screen-adaptive PDF version of MRH magazine

*This PDF will try to fill the screen. If the screen is wide enough, it displays two facing pages (emulating the old landscape format), otherwise it displays one page in portrait.*

*On mobile devices, if you change your device orientation, the PDF adapts to fill the screen with either a portrait or a landscape view as appropriate.*

## **WORKS BEST WITH ...**

- Windows: open with Acrobat or Firefox
- Mac: open with Preview, Acrobat, or Firefox
- Linux: open with Acrobat or Firefox
- Apple iPad or iPhone: open with SideBooks app (free)
- Android tablet or phone - open with SideBooks app (free)

*If you're not seeing the PDF adapt, then your PDF viewer lacks the adaptive display feature. Please use one of the recommended free PDF viewing apps listed above to get the screen adaptive behavior. Or try the Wide Edition instead.*



# SCHOOL'S OUT FOR THE SUMMER!

GET THE KIDS ON BOARD FOR FUN WITH...



## NEW GLOW IN THE DARK TRANKIDS SETS

#15 000 100 Trankids Glow in the Dark Passenger Train Set

- Powered Locomotive and First Class Battery Car
- 2 Passenger Cars and Unpowered Locomotive
- 38" x 56" oval incl. 12 pieces of Curved & 4 Pieces of Straight Track
- Remote Control operated
- Headlight, horn, bell & "Welcome Aboard" announcement

*Train and included track glow green while on board lighting illuminates the glowing track!*

## NEW GLOW IN THE DARK TRANKIDS ACCESSORIES

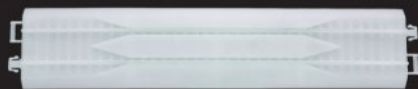

#15 000 110 - Trankids Magic Rerailer (2 pcs.)

The addition of the Magic Rerailer makes it quick and easy for little hands to get their trains back on track!



#15 000 107 - Trankids Glow in the Dark Left & Right Switch Set



#15 000 000 Trankids Passenger Train Set features:

- Amtrak® Acela® Powered Locomotive and First Class Battery Car
- Cafe Car, Business Class Quiet Car<sup>SM</sup> and Unpowered Locomotive
- 38" x 56" oval incl. 12 Pieces of Curved; 4 Pieces of Straight Track
- Remote Control operated headlight, horn, bell & "Welcome Aboard" announcement

## ORIGINAL TRANKIDS SETS & ACCESSORIES



The addition of the Magic Rerailer makes it quick and easy for little hands to get their trains back on track!

#15 000 010 - Trankids Magic Rerailer (2 pcs.)



#15 000 007 - Trankids Glow in the Dark Left & Right Switch Set

CHECK OUT THESE FUN PRODUCTS & MORE!

**CLICK HERE!**

ATLAS MODEL RAILROAD CO, INC. • 378 Florence Ave., Hillside, NJ 07205 • 908-687-0880



REGISTER  
(free)

INDEX

TABLE OF CONTENTS

# STAFF

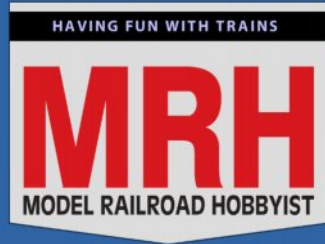

Model Railroad Hobbyist | July 2023 | #161

## Editorial Staff



Joe D. Fugate, Publisher and Editor



James Regier, Assistant Editor



Patty Fugate, Pasteup and Layout



Richard Bale, News and events



Jeff Shultz, News and events, Tech Assistant



Mike Dodd, Copy Editing

Get more issues like this



ISSN 2152-7423

V1.0 July 15

## Advertising

Les Halmos, Account Manager

Jean-François Delisle, Marketing Assistant

## Regular contributors

Eric Hansmann, Contributing editor

Jim Six, Limited Modeler column (RE)

Ken Patterson, Reporter-at-Large

## Rotating Columnists (RE)

Greg Baker, Getting Real column

Jeff Johnston, Getting Real column

Marty McGuirk, Getting Real column

Mike Rose, Getting Real column

Tony Thompson, Getting Real column

Published for the glory of God. [What's this?](#)



# MRH SPONSORS



Model Railroad Hobbyist | July 2023

## A - L



[acculites.com](http://acculites.com)



[railroadhobbyshow.com](http://railroadhobbyshow.com)



[www.atlasrr.com](http://www.atlasrr.com)



[bachmanntrains.com](http://bachmanntrains.com)



[berretthill.com/trains](http://berretthill.com/trains)



[blairline.com](http://blairline.com)



[coffmaneng.com](http://coffmaneng.com)



[deluxematerials.co.uk](http://deluxematerials.co.uk)



[www.digitrax.com](http://www.digitrax.com)



[esu.eu/en](http://esu.eu/en)



[handlaidtrack.com](http://handlaidtrack.com)



[iascaled.com](http://iascaled.com)



[litchfieldstation.com](http://litchfieldstation.com)

[Vendors: Get your clickable logo on these pages ...](#)



**REGISTER**  
(free)

[INDEX](#)

[TABLE OF CONTENTS](#)

# MRH SPONSORS | 2

## M - Z



[micro-trains.com](http://micro-trains.com)



[store.mrhmag.com](http://store.mrhmag.com)



[www.modelrectifier.com](http://www.modelrectifier.com)



[handlaidtrack.com/mt-albert-scale-lumber](http://handlaidtrack.com/mt-albert-scale-lumber)



[ncedcc.com](http://ncedcc.com)



[www.pwrs.ca/main.php](http://www.pwrs.ca/main.php)



[opsig.org](http://opsig.org)



[rapidotrains.com](http://rapidotrains.com)



[ringengineering.com](http://ringengineering.com)



[rockislandhobby.com](http://rockislandhobby.com)



[scalatrains.com](http://scalatrains.com)



[scottantiquemarket.com](http://scottantiquemarket.com)



[www.siskiyouline.com](http://www.siskiyouline.com)



[soundtraxx.com](http://soundtraxx.com)



[sodigi.com](http://sodigi.com)



[sbs4dcc.com](http://sbs4dcc.com)

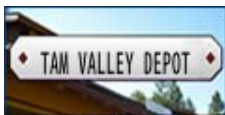

[tamvalleydepot.com](http://tamvalleydepot.com)



[train-fest.com](http://train-fest.com)



[walthers.com](http://walthers.com)

Looking for something? Check the MRH Marketplace!

MRH MARKETPLACE | 2

**When talking to hobby vendors, please remember to mention MRH.**

**Take me there!**

# NEW

from the  
**Model Railroad  
Hobbyist Store**

Running time:  
3 hrs 16 min

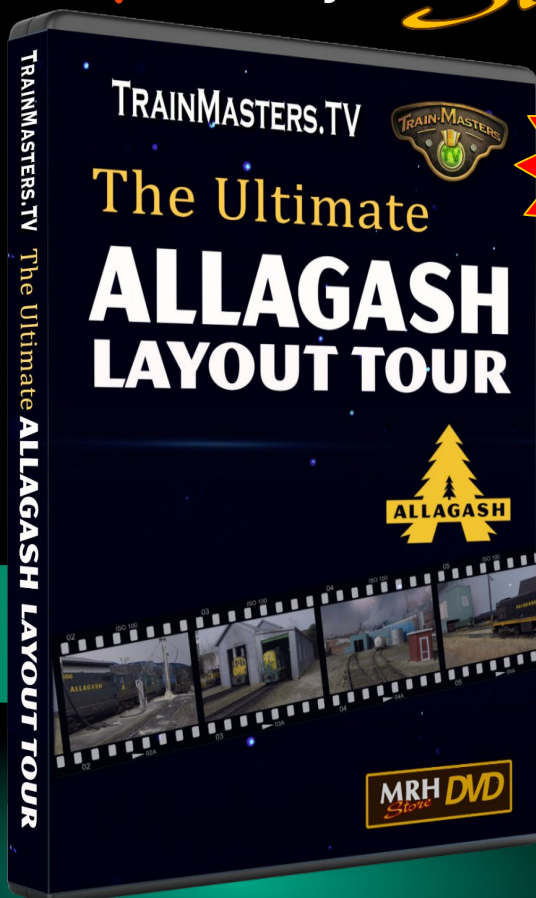

**NEW!**

Download  
~~\$19.99~~

\$9.99

DVD  
~~\$30.00~~

\$21.77

Available NOW

2-disk DVD set Available NOW

Get Video  
Download

Get  
2 DVD Set

Download in full 1080 HD

DVDs: FREE SHIPPING US  
50% OFF SHIPPING FOREIGN



REGISTER  
(free)

[INDEX](#)

[TABLE OF CONTENTS](#)



**Publisher's Musings: Selective compression / negative space ...**  
*JOE FUGATE*



**MRH Website this month: Back to the Future III loco, ...**  
*Compiled by JOE FUGATE*



**What's Neat: Building an HOn3 layout: 2, ...**  
*KEN PATTERSON*



**Electrical Impulses: DCC car lighting circuit**  
*RICHARD NAPPER*



**Mike Armstrong's Rock Island**  
*the MRH STAFF*



**Design tips for control panels**  
*SCOTT DUNLAP*



**Savvy Modeler online: ESU LokSound diesel install**  
*Compiled by the MRH STAFF*



**July 2023 news and events**  
*RICHARD BALE and JEFF SHULTZ*





# SHOP IN STOCK ITEMS TODAY

WHILE SUPPLIES LAST



GE 8500 HP "Big Blow" Turbine

N  
1:160 SCALE



EMD GP30

HO  
1:87 SCALE



GE DASH 9

HO + N  
1:87 SCALE 1:160 SCALE



GE ET44

HO + N  
1:87 SCALE 1:160 SCALE



GE Standard Turbine

N  
1:160 SCALE



Tenders

HO + N  
1:87 SCALE 1:160 SCALE



**SCALE**  
TRAINS

**SHOP NOW**

[www.ScaleTrains.com](http://www.ScaleTrains.com)

ScaleTrains • 4901 Old Tasso Rd NE, Cleveland, TN 37312

844-9TRAINS 844-987-2467 • International 423-299-3689



CLICK THIS AD

© 2023 ScaleTrains, Rivet Counter, Railroad, Road Number, and Era Specific and respective logos are trademarks of ScaleTrains.com, Inc. This product is made under trademark license from Union Pacific Railroad and CSX Transportation.



REGISTER  
(free)

[INDEX](#)

[TABLE OF CONTENTS](#)



# PUBLISHER'S MUSINGS



Model Railroad Hobbyist | July 2023



JOE FUGATE TALKS ABOUT SELECTIVE COMPRESSION AND NEGATIVE SPACE ...

**YOU CAN TELL A NEW MODELER HAS MADE THE FIRST** big transition to more savvy modeler once they realize they can't fit the entire Union Pacific into their layout space.

Selective compression is a requirement for all but the most limited of layout scope. Basically we keep the most iconic and memorable elements of the rail line we're looking to model, and then we throw out the rest.

And what we do keep, we likewise cleverly shrink it down, dropping the number of elements down, yet still retaining the overall feel for those familiar with the prototype.

My Siskiyou Line 1 layout space was about 50 feet long in its largest dimension.

In HO, that's maybe four thousand feet at 87 to 1. Imagine the futility of trying to cram the entire Siskiyou Line route from Eugene, Oregon to Roseburg, Oregon, a 60-mile distance, into a four thousand feet of distance.

## Macro and micro selective compression

Selective compression can be applied at two basic levels – at the “macro” level to tease out the signature elements of the

entire rail line we're looking to model. Then there's micro-level selective compression where we're shrinking down that rail yard by reducing the number of tracks, or we're shrinking down that massive warehouse by going from ten doors to four.

In all cases, selective compression works to disguise the fact we've removed several of the pieces. By determining and keeping the "signature" elements, we're aiming for the compressed result to still be easily recognizable as a facsimile of its prototype.

## **Selective compression examples**

Right off the bat, selective compression starts with reducing the length of the trains we're running on the layout. Instead of 100 car monsters, we're looking to model say a 20-car train, including the head-end power, mid-train helpers, and caboose.

One trick I have found when trying to decide on how long to make the selectively compressed trains has been to consider field of view. What length of train is needed to look sufficiently "long" when viewing it?

Let's say I'm focusing on the middle of a train passing by and I'm right next to it running on a shelf say less than 24" wide. If the front and the rear of the train are outside my field of view at that point, then the train feels "long" to me.

Another selective compression trick often used on model railroads is to tighten clearances. I can place that highway paralleling the rail line closer than needed in real life and it will look fine.

Another selective compression trick with regard to highways is the markings. Center dashed lines can have dashes far shorter and closer together than in real life, especially when modeling a freeway. In fact if you model the actual size and spacing of center dashed highway lines, they often just look wrong.



# EAST TRACKS

Build your own trackwork easily, quickly, and affordably.

## TRACK BUILDING SYSTEM

Tim Warris developed the Fast Tracks system in 2003 out of his garage while building his Port Kelsey Railway in HO scale. Striving for a better way to handlay accurate track, he developed a fixture to aid in building trackwork faster and easier.

CELEBRATING  
**20**  
 SINCE  2003  
 YEARS



Those first fixtures have since grown to a library of over 5,000 unique products that are focused on helping modelers build better trackwork and layouts around the world.



• Easy ordering •

shop online 24/7 • [handlaidtrack.com](http://handlaidtrack.com)

1-888-252-3895

[service@fast-tracks.net](mailto:service@fast-tracks.net)

I think part of the reason for this is because we typically see the center dashed line of a highway from a few feet off the road in our vehicle, which greatly compresses their length and spacing. We're not used to seeing highway center lines from a helicopter view.

Other things that get selectively compressed are parking lots and sidewalks. Cut and fill slopes are also generally compressed to be steeper than what would be typical on a real railroad or highway.

Another selectively compressed item that's often not obvious is trees. If you step back and look at trees along a real railroad right-of-way, you will often find the trees tower above the trains, sometimes 50-75 feet or more. Yet the typical model railroad tree is usually about 15-25 scale feet high.

Terrain contours also get selectively compressed, mainly because we just don't have the vertical space needed, especially to model mountainous regions.

A mountain slope may rise up many hundreds of feet to thousands of feet. Canyons may drop up a hundred to a thousand feet below the tracks.

Yet a three-foot mountain or canyon is considered massive on our layouts. We may also use forced perspective to have the trees and objects further up the mountain be much smaller than the ones down closer to the tracks.

And of course, there's selectively compressing structures and bridges. We reduce the number of bays, windows, doors, and floors, while still striving to still maintain the general look and feel of the structure.

On my Siskiyou Line 1, I selectively compressed a signature scene of the railroad truss bridge over the North Umpqua river. The crossing had three spans, but because of trees blocking the view, you could often just see two spans, so I reduced my model from three spans to two.



**WALTHERSPROTO.**

# WORKHORSE POWER FOR YOUR HO RAILROAD



## EMD GP9 PHASE II DIESELS

Improved hood contours & Phase II details

Proven power at every speed with a 5-pole, skew-wound can motor, 14:1 helical gears, all-wheel drive and electrical pick up.

Railroad-ready with road-specific details

### IN STOCK

**LokSound 5 Sound & DCC \$319.98 Each**

920-42713 to 42725 Series

**Standard DC \$219.98 Each**

920-49713 to 49725 Series

Available roadnames: Chicago, Burlington & Quincy\*, Grand Trunk Western, Nickel Plate Road, Southern Pacific† - Passenger Service Black Widow, Southern Pacific† - Freight Service Black Widow, Southern Pacific† - Freight Service Gray, Undecorated

**Check out the full lineup  
at [walthers.com](http://walthers.com).**

**WALTHERS®**

Support your local hobby shop • visit [walthers.com](http://walthers.com) • call 1-800-487-2467

Prices and availability shown were accurate at press time, for updates, visit [walthers.com](http://walthers.com). \*The Burlington marks are licensed marks owned by BNS Railway. †Union Pacific licensed product. © 2023 Wm. K. Walthers, Inc.



**ELECTRIC EXPRESS****COMING THIS CHRISTMAS!**

Tin Toy-style  
train set comes  
with 3D printed  
robots & robot  
part loads!



Renderings shown for representation only.



**MICRO-  
TRAINS®  
LINE**

**CLICK HERE FOR MORE INFO**

**N**  
SCALE 1:160

**Z**  
SCALE 1:220

## PUBLISHER'S MUSINGS | 4

I also cut one panel out of the girders under the track, reducing the length between bridge uprights from four panels to three. I also reduced the height of the bridge by 20% to maintain the overall proportion of the bridge, length to height.

As a result, I reduced what would have been a six-foot bridge crossing to just under four feet – almost by one third. Most people never even noticed, yet if they knew the prototype scene they recognized it immediately.

Notice we all have to selectively compress reality to varying degrees in order to get it to fit into our limited layout space. Even the most ardent prototype modeler who is a stickler for no-compromise prototype accuracy needs to remember, we're all "faking it" when it comes to the actual space required by the prototype as compared to our model scenes.



**REGISTER**  
(free)

[INDEX](#)

[TABLE OF CONTENTS](#)

# AUCTION

MODEL RAILROAD  
HOBBYIST COLLECTION  
ORIGINAL BOXES INCLUDED!



**570+ LOTS**

**CLICK HERE  
TO BID!**



## Write for MRH / Running Extra!

WE'RE LOOKING FOR  
ARTICLES, SO WRITE-UP  
WHAT YOU'VE DONE, AND  
SEND IT IN !

*How to write  
for us*

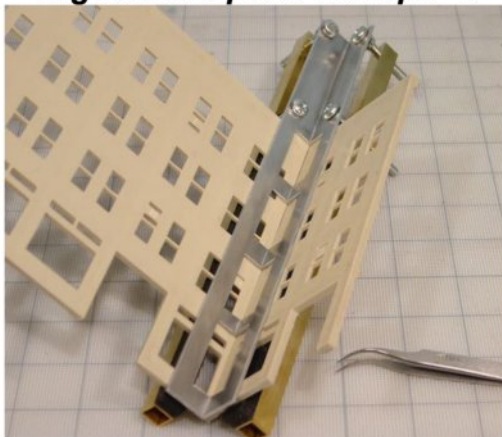
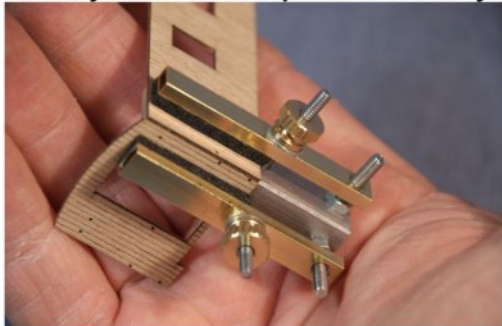
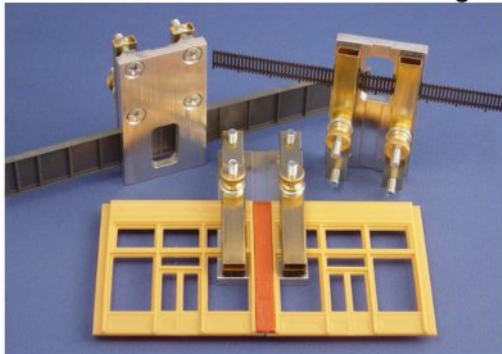

**"Right and Splice Clamps"™****Quality Tools with Superior Versatility****Essential Tools for Great Modeling**

**Coffman Graphic Solutions**  
1500 River Circle, Richmond KY 40475

**Click Here**

**Visit our new Website:**  
[www.coffmaneng.com](http://www.coffmaneng.com)

Also if I look at famous freelance layouts such as John Allen's Gorre & Daphetid or George Sellios' Franklin & South Manchester, they have selective compression and forced perspective applied repeatedly all across the layout.

Yet we're all still rightly amazed at the modeling these famous layouts have portrayed.

Rather than call this fakery, we call it modeler's license and praise modeling that displays the illusion with finesse.

## Negative space

In this issue's cover story, we discuss the concept of "negative space". I think negative space is a concept that selective compression sometimes runs roughshod over, and it is a concept that needs to be resurrected.

Negative space is basically the so-called "boring stuff" that has little to do with the railroad. It's the stuff that typically gets thrown out when we selectively



**REGISTER**  
(free)

**INDEX**

**TABLE OF CONTENTS**



BACHMANN®

HO SCALE  
HO  
SCALE

New York Central Express Reefer (Item No. 75702) and 80' Pullman Car (Item No. 13904) are available separately.

# POWER AND SPEED

## FOR THE WATER LEVEL ROUTE

### The HO Scale 4-6-4 J3a Hudson

As demand for rail travel increased in the 1920s, there was a need for faster, more powerful locomotives to pull express services along New York Central's Water Level Route. The solution was delivered by the American Locomotive Company in 1927, as the 4-6-4 Hudson entered service alongside its namesake Hudson River. The type became a symbol of both the New York Central and fast, luxury rail travel, powering renowned trains such as the 20th Century Limited and the Empire State Express for almost 30 years. Arriving with a diecast metal boiler and a wealth of separately-applied details, the Bachmann HO Scale Hudson is equipped with a TCS WOWSound® CD-quality 16-bit 44,100Hz decoder with Audio Assist™, and a Keep Alive® device for optimal performance. Sound features include user-definable whistle options, numerous mechanical effects, station announcements, and Chuffinity™ technology for appropriate load-based chuff intensity, bringing you closer to experiencing the legendary Hudson in person than ever before.



**NEW YORK CENTRAL #5407**  
(as delivered Roman lettering)  
Item No. 53601

NEW



**NEW YORK CENTRAL #5413**  
(as delivered Roman lettering)  
Item No. 53602

NEW



**NEW YORK CENTRAL #5432**  
(gothic lettering)  
Item No. 53603

NEW



**NEW YORK CENTRAL #5438**  
(gothic lettering)  
Item No. 53604

NEW

[Click to learn more](#)

#### Features include:

- DCC On Board® with TCS WOWSound® for true CD-quality audio in 16-bit 44,100Hz sound
- Keep-Alive® device that keeps your engine running during power interruptions due to dirty track or loss of electrical contact
- voice-guided Audio Assist™ programming tool for easy set-up of almost all decoder functionality
- Chuffinity™ technology for authentic load-based chuff intensity
- die-cast metal boiler with separately applied details
- all-metal chassis
- dual-mode NMRA-compliant decoder for DCC and analog operation
- operating directional headlight and reverse light
- working blackened metal side rods
- blackened metal wheels with RP25 contours
- E-Z Mate® Mark II couplers - front and rear

SHIPPING NOW! • MSRP: \$479.00 each

Bachmann Industries, Inc. • 1400 East Erie Avenue • Philadelphia, PA 19124 USA • [www.bachmanntrains.com](http://www.bachmanntrains.com)

[Click for more information.](#)



[MRHMAG.COM](http://MRHMAG.COM)

[INDEX](#)

[TABLE OF CONTENTS](#)

compress a railroad route into a layout track plan. Rather than adding something else “railroady” to the layout, a “negative space scene” takes space away from the railroad part per se, hence the term “negative” space.

But let’s hold on for a moment. One of the things I really dislike about a layout is when the front of the train is rolling into the next town when the rear of the train is still in the last town.

It’s even worse when it’s a mountain grade. It just feels off when the locos are cresting the summit and the caboose is still back at the foot of the grade. My Siskiyou Line 1 had this very situation on one side of the grade up to Rice Hill, and I hated it.

There’s another name for negative space: running space between towns. Modeling those rural scenes that are so typical alongside 90% of the railroads in North America just feels correct, so we need to balance out selective compression by adding back in some negative space in our layout scenes.

In fact, a well-done negative space scene on a layout can become a signature scene in its own right.



1. The Knox Farm scene on Mike Confalone’s Allagash is a great example of how “negative space” that’s “mostly nothing” can become a signature scene in its own right.





Make it run like a

# Dream TRACKWORK BOOK

104 pages

*By Joe Fugate*

SUMMER  
SPECIAL

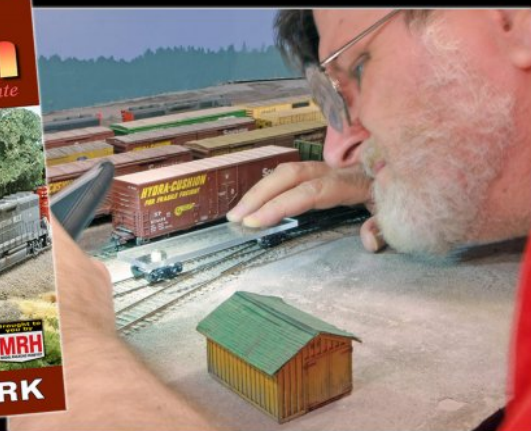
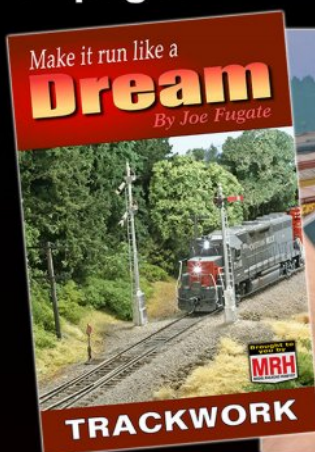

Available from the MRH Store: [store.mrhmag.com](http://store.mrhmag.com)

"The new bible of track laying." - L.T.

"Chapter 3 alone is worth the cover price." - B.M.

"A lot of info ... copiously illustrated.." - J.A.

Click me to

Get eBook NOW >>

~~\$14.99~~ \$9.49

Format: Landscape and Portrait  
PDF

Click me to

ORDER PAPERBACK >>

~~\$31.99~~ \$27.99

FREE shipping in US!  
Foreign shipping 50%

Other books in this series: **ROLLING STOCK** (available now) and **LOCOS** (end 2023)

[MRHMAG.COM](http://MRHMAG.COM)

[INDEX](#)

[TABLE OF CONTENTS](#)

# THE DOME LOUNGE



# CLICK HERE



Quality. Style. Spirit.™

[rapidotrains.com](http://rapidotrains.com) • [youtube.com/RapidoTrains](https://www.youtube.com/RapidoTrains) • [facebook.com/RapidoTrains](https://www.facebook.com/RapidoTrains)

RAPIDO



REGISTER  
(free)

[INDEX](#)

[TABLE OF CONTENTS](#)

One of the great examples that I think of here is the iconic Knox Farm scene on Mike Confalone's layout [1]. There's basically nothing there except a big pasture and a barn and farmhouse in the distance.

## The survey has ended

Our 2023 Reader Survey has ended. Next month in my editorial we will announce the drawing winners, and we will begin reviewing the survey results with you.

Along the way, we'll compare the results with past surveys to see what hobby trends there might be.

It's also convention season and we're attending several conventions this summer. If you're an MRH reader, stop by and say hello! ☑

**Did you see this article?**

*in the* **JUNE 2023 MRH RUNNING EXTRA!**



**Non-flaking handrail paint**

**Get full eBook now ▶** ← *click here*

Each eBook has 80-100 pages



Get more articles like this

**GIVE IT A LIKE**



# Every little bit helps!

Registered MRH readers  
get **another** 10% off with  
the coupon code here:



Reveal my  
coupon code now!

[click here](#)

That's right, on top of our  
other sales and discounts, use  
this coupon code to get  
**YET ANOTHER 10% off!**



Summer's  
comin' ...



**TMTV sale offers**

[click here](#)

Model  
Railroad  
Hobbyist  
Store

**MRH Store sale offers**

[click here](#)



**REGISTER**  
(free)

[INDEX](#)

[TABLE OF CONTENTS](#)





## LAST ISSUE LIKES

Most liked articles in [June 2023 issue](#) of *MRH* are:

- 1st** Dean Ferris' Oregon Joint Line
- 2nd** Modeler's survey of glues: 3
- 3rd** Publisher's Musings: More than just the free magazine

Most liked articles in [June 2023 issue](#) of *Running Extra* ...

- 1st** From summer to autumn on the Cass County
- 2nd** Limited Modeler: Life's hobby lessons
- 3rd** Operating steam throttle you can customize, part 2

**If you want more of this type article, then like the article!**  
Click the *Give us a like* or *comments* button on each article and press the like button on the article's forum page if you want to see more articles like these. ■

Get the latest Model Railroading News, Tips, Reviews & Opinions

**CHECK  
IT OUT!**



**Our iTunes feed has changed search for  
"Crew Call with Mike Rose" to receive the latest episodes!**

**[www.themodelrailroadpodcast.com](http://www.themodelrailroadpodcast.com)**

Host:

Mike Rose: [www.mrhobby.com](http://www.mrhobby.com)

**Don't Miss our Monthly Interviews  
& Product Announcements**



In

**MRH****RUNNING  
EXTRA**

July issue ...

**TABLE OF CONTENTS | RUNNING EXTRA**

July 2023

**RUNNING  
EXTRA****Publisher's Welcome: Stripping fine decoder wires**

JOE FUGATE

**Limited Modeler: Pick-a-year layout operation**

JIM SIX

**Getting Real: A question of color**

JEFF JOHNSTON

**Finding decoder install examples**

JOE FUGATE

**Scratchbuilding roadway signs**

MICHAEL ANTEAU

**3D-printed Schnabel car and transformer load**

JEAN-YVES MAZZOLENI and JOËL LESAGE

**Ah-Hah Moment: More cool superglue hacks**

JOE FUGATE

**Buy July eBook - \$2.99****85 pages**[store.mrhmag.com](http://store.mrhmag.com)*Also includes  
165-page MRH  
in the back!***REGISTER**  
*(free)*[INDEX](#)[TABLE OF CONTENTS](#)

Best of the

# MRH FORUM

Forum

MRH  
mrhmag.com

THIS  
MONTH

Model Railroad Hobbyist | July 2023

Compiled by **JOE FUGATE**



## The Back to the Future III locomotive?

New *MRH* forum member **javiercairo8** started a thread about the Back to the Future III steam locomotive. He's building a model of the DeLorean and the locomotive ... follow this fascinating thread!



[View the full thread on the MRH website](#)

► **MRH'S MONTHLY GREAT MODELER POSTS**



1. *MRH* forum member **TimGarland** has a blog about his new Seaboard Central layout – it features many posts about his layout progress, and includes a number of videos of the layout in operation.

## The New Seaboard Central HO Model Railroad

*MRH* forum member **TimGarland** bought a new house in 2022 and started a layout blog on the *MRH* forum journaling the progress on this new layout.

Tim started with getting his space organized and developing a new track plan. He also brought pieces of his old layout with him when he moved to the new house, so he started out with a leg-up on getting things running.

“This layout should support one to four operators. I use the ProtoThrottle, so I like to run sessions with two man crews, an engineer and conductor.”

Check out the full discussion for all the details.

[View the full thread on the MRH website](#)



**REGISTER**  
(free)

[INDEX](#)

[TABLE OF CONTENTS](#)



Second Weekend, Every Month!

## Scott Antique Markets

featuring

### ANTON'S ANTIQUE TOY & TRAIN SHOW

2023 Dates

~~Feb. 9 - 12~~      **Sep. 7 - 10**

~~Apr. 6 - 8~~      **Nov. 9 - 12**

Atlanta Expo Centers

3650 & 3850 Jonesboro RD SE  
Atlanta, GA 30354

For Full Schedule & Coupons  
Visit our website.

[www.scottantiquemarkets.com](http://www.scottantiquemarkets.com)

ADVERTISEMENT

**Lasercut structures. Highway,  
storefront and billboard signs.**

Neat ag customer for your railroad:  
**Farmers Fertilizer Supply**



Established 1993...

## Blair Line

ADVERTISEMENT

## Shed new light on your railroad

**NEW**

**PLATFORM/  
YARD LIGHTS**



**NEW**

**STADIUM/  
PARKING LOT  
LIGHTS**



Plus a full line of vintage thru modern lighting for  
model railroad layouts

**RIH**  
Rock Island Hobby

Realistic scale accessories:  
automobiles, lights, figures,  
scenery, military actions rail  
cars and more.

Click for details: [www.rockislandhobby.com/collections/all-scales](http://www.rockislandhobby.com/collections/all-scales)

## Siskiyou Line

Professional Grade Railroad Materials

Protect your locomotives & carry them safely.



1 Box \$39.95

Free shipping in Continental U.S.

[SiskiyouLine.com](http://SiskiyouLine.com)

HO Loads,  
Cars and Materials  
Proudly Made In The U.S.A.

*Mention that you saw our ad on  
MRH and NMRA magazine!*

2. Every so often, someone will post something on an *MRH* forum thread that reminds us all there's a lot of excellent modeling going on out there. This model photo by *MRH* forum member **AVT** (Anthony T.) shows an excellent eye for scenery. He posted this photo on a thread by **NorthWoods Bill** about his rock mold technique. Anthony posted this photo to illustrate how rock molds can make convincing scenery. We can't wait to see the final scene, it's already some fantastic work.



## Great large rock molds

*MRH* forum member **NorthWoods Bill** (William R.) started a thread about how to use larger rock molds to get some great rock-work for your scenery.

“Recently I came across a post on this forum about Bragdon rock molds. I knew about Woodland Scenics and [another vendor’s molds], but nothing else. I had no idea a company making rock molds as incredible as those made by Bragdon even existed. This post highlights a casting I made this afternoon hoping it may make even more modelers aware of them.”

Follow the entire rock mold discussion on this thread.

[View the full thread on the \*MRH\* website](#)



[REGISTER](#)  
(free)

[INDEX](#)

[TABLE OF CONTENTS](#)





**24TRAINS.TV** *It's all about trains*



*All things train related,  
whenever, wherever.*



**[WWW.24TRAINS.TV](http://WWW.24TRAINS.TV)**

**On 24TRAINS.TV you can find:**

videos | travel reports | magazines | vlogs

model railways | workshops | documentaires | holidays

[MRHMAG.COM](http://MRHMAG.COM)

[INDEX](#)

[TABLE OF CONTENTS](#)

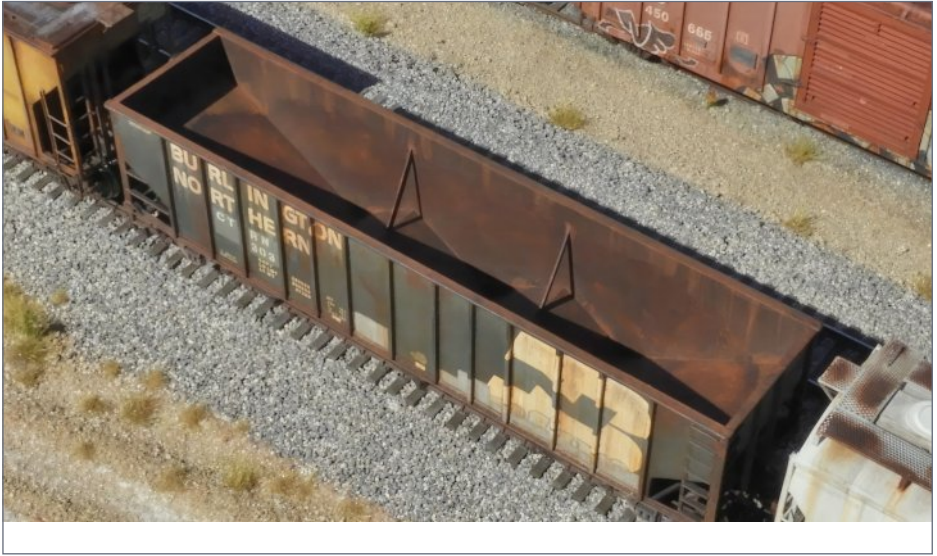

3. *MRH* forum member **Terrence510** (Terrence B.) posted this amazing photo of his hopper car model.

## Show us your hoppers

*MRH* forum member **CNW Chet** (Chet G.) started a forum thread after the “show us your \_\_\_” theme, this time hoppers.

These “show us” threads usually have some amazing work and a few surprises – this thread has been especially so.

There been well over 100 hopper photos posted on this thread and many are just as amazing as [3] above. Many have remarked that this thread completely rocks and it’s loaded with eye-popping photos of some fantastic modeling.

Check out the full thread – and prepare to be totally and completely blown away.

[View the full thread on the \*MRH\* website](#)



[REGISTER](#)  
(free)

[INDEX](#)

[TABLE OF CONTENTS](#)

## Weekly photo fun thread ...

Each week, our forum has a weekly photo fun thread. It's always a delight to see photos of our forum members' modeling.

View the full thread on the *MRH* website



4. *MRH* forum member **Terrence510** (Terrence B.) posted this image of his tank car model photographed on an outside diorama. Someone posted they'd like throw a rock at it just to hear the ping ... it's *that* real looking!



5. *MRH* forum member **Mark Mathu** posted this impressive photo of a club member's Santa Fe GE Dash 8 model. Mark used his iPhone8 to take several photos at different focus settings and then did focus stacking to get the final image.

Get more articles like this

GIVE IT A LIKE





Agrium | PotashCorp before...

...after **Nutrien**  
Feeding the Future™**Merger Completed Forming Nutrien, a Leader in Global Agriculture**

SASKATOON, Jan. 2, 2018 /CNW/ - Nutrien Ltd. (Nutrien) (TSX and NYSE: NTR) today announced the successful completion of the merger of equals between Agrium Inc. (Agrium) and Potash Corporation of Saskatchewan Inc. (PotashCorp), creating the world's premier provider of crop inputs and services. Nutrien has the largest crop nutrient production portfolio combined with an unparalleled global retail distribution network that includes more than 1,500 farm retail centers. With nearly 20,000 employees – and operations and investments in 14 countries – the company is committed to providing products and services that help growers optimize crop yields and their returns.

**Nutrien (POTX) - National Steel Car Potash Service 4300 cu.ft. 3 Bay Covered Hopper**48 road numbers,  
available exclusively at:**Pacific Western Rail Systems****HO****N****Marine Industries  
4550cuft 4 Bay  
Cylindrical Hopper****First time ever available in HO!**

A couple of years ago a customer asked us at a large Train Show why we didn't like Canadian National. When we explained we did not have any reason to dislike Canadian National, we asked why he had that impression. "Well you are not making any of the Hawker Siddeley Cylindrical Hoppers in CN with large Noodle graphics".

To which we replied "That's because Hawker Siddeley didn't make any Cylindrical Hoppers for CN (4550 cuft) with large Noodle graphics".

The customer then showed us images of what he thought were Hawker Siddeley 4550 cu ft Cylindrical 4 Bay Hoppers with CN Noodle Graphics. We then explained, the images he was showing us were not Hawker Siddeley built cars, they were built by Marine Industries in Quebec.

About 30% of the 4550 cu ft Cylindrical Hoppers were built by National Steel Car (NSC), and 40% were built by Hawker Siddeley (HS) and the balance were built by Marine Industries Limited (MIL). Many modelers confuse the HS car with the MIL car. Although similar they are very different, "If you know what to look for when closely examining the cars".

**Remember, these cars have never been available before in HO Scale.**

In test marketing customers have asked us to run 12 road numbers for five of the paint schemes. All the rest we will produce 6 road numbers. We will also do 6 cars equipped with Toggle Lock Pneumatic Gravity Gates! (see close up image above)

**HO****N****Pacific Western Rail Systems****NORTH AMERICAN RAILCAR CORPORATION****REGISTER**  
(free)**INDEX****TABLE OF CONTENTS**



# WHAT'S NEAT

column



Model Railroad Hobbyist | July 2023

KEN PATTERSON COVERS THIS MONTH:

- PART 2 OF A 3X8 HON3 LAYOUT THAT STARTED AS A SIMPLE RUN BY
- INSTALLING SOUND ON A BLI STEALTH LOCOMOTIVE
- BACHMANN'S TYLER HANEY SHOWS OFF NEW AND UPCOMING PRODUCTS



*click to play video*

PHOTOS AND VIDEO OF SUPERB MODELS

**THIS MONTH KEN CONTINUES A SERIES ON HOW HE BUILT** a 3x8 HO<sub>n</sub>3 run-by video and photo diorama and then turned it into a layout. Broadway Limited sent Ken one of the new SD40 Stealth locomotives and had him install a speaker and SoundTraxx Econami decoder. Bachmann's Tyler Haney drops in via Skype to show some upcoming HO scale products.

To see all the modifications Ken made to the layout, how he installed sound in the BLI Stealth SD40, and the upcoming products from Bachmann, click on the video link at the beginning of the article.



## Building a 3x8 foot layout



1. To start converting the run-by diorama into a layout, Ken adds a third layer of foam and routs out a slot along the side of the layout to hold the anchors for the oak fascia.



[REGISTER](#)  
*(free)*

[INDEX](#)

[TABLE OF CONTENTS](#)



2. Oak plywood is soaked with water and shaped to fit the sharp curve at one end of the layout.



3. Using several new turnouts and sections of track, the future track plan is expanded with a yard, industry, turntable, and roundhouse.





4. At the opposite end of the layout Ken begins modifications that will allow him to add a trestle scene.



5. To expand the area available for the roundhouse, Ken replaces an entire section of foam in the middle of the layout.





6. To control the power directed to the various industry and yard tracks, Ken built Plexiglas control panels with switches.



7. Using a hot knife, Ken carves holes in the foam to hold the control panels.



8. The new track is glued into place and weathered with spray paint.



9. Ken wraps up this segment by installing the control panels.



**REGISTER**  
*(free)*

[INDEX](#)

[TABLE OF CONTENTS](#)

## Installing sound in a BLI Stealth Locomotive



10. BLI sent Ken a new Stealth SD40 in Santa Fe paint, a SoundTraxx Econami DCC decoder, and a speaker designed for the SD40. And then they told him to show us how to put it together.

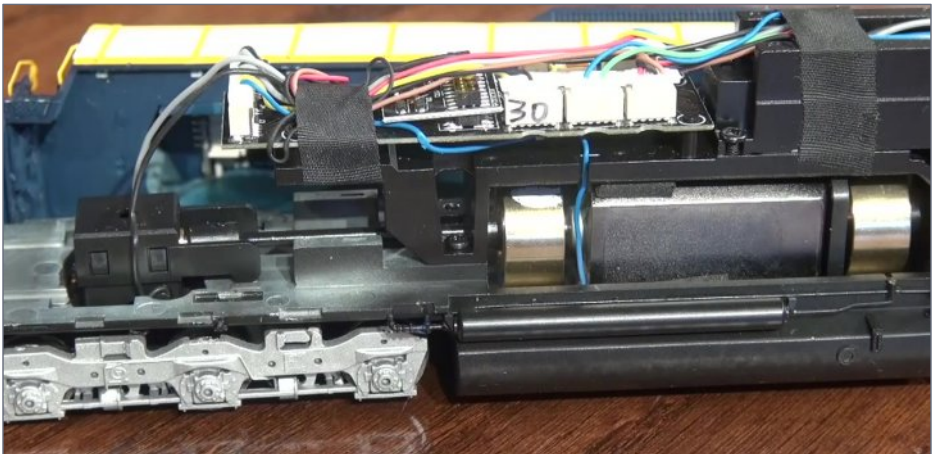

11. The locomotive comes with a 21-pin dummy plug that allows it to be used on DC layouts, and a space between the circuit board support and the drive line for the speaker.





12. After installing the speaker and Econami decoder, Ken tests it on his layout. Soundtraxx decoders frequently include a blue status LED that lights up to indicate they are powered up.



13. After reinstalling the shell, Ken took the locomotive out for a spin.



**REGISTER**  
*(free)*

[INDEX](#)

[TABLE OF CONTENTS](#)



## Tyler Haney shows off some upcoming products from Bachmann



14. Tyler shows the first test sample of the upcoming EMD BL2 locomotive in HO scale.

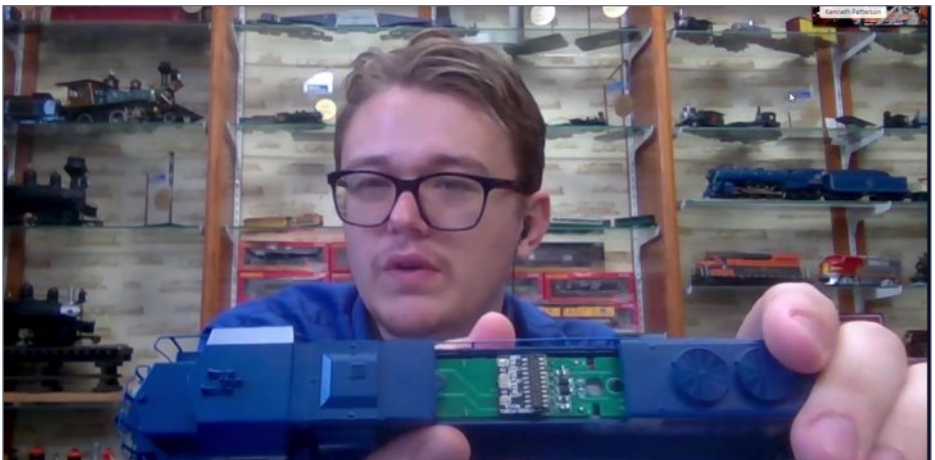

15. Bachmann is updating the electronics in its locomotives to incorporate the NMRA 21-pin decoder socket, as seen on this upcoming Missouri Pacific GP38-2.



16. Tyler also showed samples of the Sound Value SD40-2s in Conrail Quality and Santa Fe Kodachrome.



17. Bachmann has redesigned the HO scale PCC cars to include DCC and sound, as well as lowering the chassis and improving the look of the trucks. This model represents a series of PCC cars that SEPTA painted for the Bicentennial, with each trolley wearing the name of one of the original 13 colonies. Standard SEPTA and two unlettered paint schemes inspired by other PCC car operators will also be included in this run. ■

Get more articles like this

GIVE IT A LIKE



REGISTER  
(free)

[INDEX](#)

[TABLE OF CONTENTS](#)



# The 2023 Texas Express is around the corner!!!

Come for the HO/HOn3 scale Bear Creek & Bayou Railroad of Leo & Lorrie Palitti and lots of other great layouts, then stay for the huge FreemoN Operations Roadshow, rail tours, operating sessions, clinics, banquet speaker Spencer Christian, and so much more!!!

SUPERCHARGED - HIGH SPEED



# TEXAS



# EXPRESS

**AUGUST 20-26**

Dallas  
Fort Worth **TEXAS**

**CLICK TO REGISTER** *today!!!*  
nmra National Convention 2023TEXASEXPRESS.COM

# Digit

## Introducing the UT6 & for Digitrax Comp



- **Compact size for easy one-hand**
- **Color 1.5" LCD Screen**
- **Full numeric keys for easy Loc**
- **Fine speed control with a large**
- **Removeable LocoNet® cord**
- **Forward/Reverse toggle switc**
- **Off/On switch, uses AA or BP6**

Find out more @ [www.](http://www.)



REGISTER  
(free)

[INDEX](#)

[TABLE OF CONTENTS](#)





# UT6D Utility Throttles Complete Train Control!

Handed operation

**UT6**

Utility Throttle

**\$105.00 MSRP**

Automotive selection

**UT6D**

Duplex Utility Throttle

**\$170.00 MSRP**

Encoder knob

Hand with Braking

**View all features and *more*  
on our website!**

2400MH batteries

[digitrax.com/throttles/](http://digitrax.com/throttles/)

# Dependable **Wireless** Radio Control!



*... and **so** much more!*

**GET THE DETAILS ►**

*click here*

**RE RING**<sup>TM</sup>  
ENGINEERING



REGISTER  
*(free)*

[INDEX](#)

[TABLE OF CONTENTS](#)

# DCC track power supply for cabooses and passenger car lighting

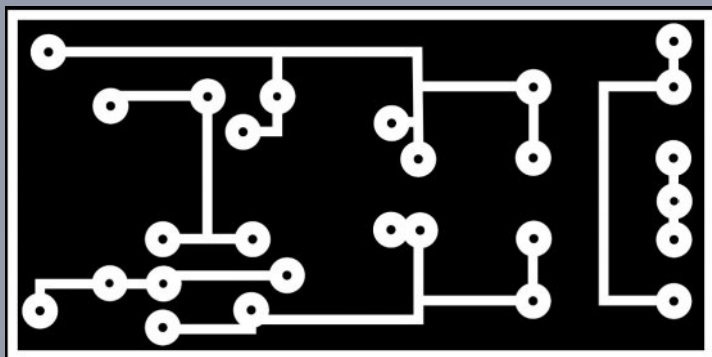

Electrical  
Impulses

1. Build your own constant lighting circuit using this simple PC board design.

Model Railroad Hobbyist | July 2023



**RICHARD E. NAPPER, MMR** SHOWS US A STEADY POWER SUPPLY FOR LIGHTS ...

**WHEN USING DCC**, many of us like to light our cars and cabooses. You could go to the expense of installing a DCC decoder, or you can build a simple, decoder-free lighting power supply for less.

I have designed a small circuit board that will fit in HO scale cabooses and passenger cars to power circuits directly from DCC track power for caboose marker lights and interior lighting. The voltage is adjustable from 1.25 V DC to 15 V DC, with up to 150 mA current. "My preference is using LEDs, but this circuit will also run 1.5 V bulbs.

Here is the parts count for one 25 mm x 50 mm circuit board:



# Southern Digital

[WWW.SODIGI.COM](http://WWW.SODIGI.COM)

*Celebrating 28 Years serving you*

## Over 180 Decoders to pick from!

We have all sizes and shaped decoders from Z-Scale to G-Scale, motor only, sound only, motor+sound plus stationary decoders.



### Digitrax



### Soundtraxx



### TCS



### NCE

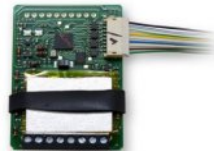

86 N-Scale Mobil Decoders to pick from  
17 N-Scale Sound + Motor to pick from  
7 Stationary Decoders to pick from

22 HO Mobile decoders to pick from  
56 HO Sound + Motor to pick from  
2 O/G Scale Motor + Sound to pick from

## DCC Conversions, Service & Support

E-mail: [sales@sodigi.com](mailto:sales@sodigi.com) (770) 929-1888



REGISTER  
(free)

[INDEX](#)

[TABLE OF CONTENTS](#)



**STREAMLINED BACKSHOP**

Sales ... Service ... Solutions ...



# ZIMO MS Sound ?

Learn more ...

[WWW.SBS4DCC.COM](http://WWW.SBS4DCC.COM)



ADVERTISEMENT

## Great control in a tiny package



**Original  
Touch Toggles**

- Touch Toggle™ plug in controls
- Bright clear indication
- Easy setup
- Flexible system

Stall Motors, Twin-coils,  
Power, and Servos

Now for Tam Valley Depot  
and MRservo too!



**BERRETT  
HILL  
TRAINS**

Made in the USA



What will they think of next?

[www.berretthillshop.com](http://www.berretthillshop.com)

- (4) 1N4001 diodes, Digi-Key 3372-1N4001TB-ND
- (1) 470 uF, 25V radial lead the electrolytic capacitor, Digi-Key 1189-1869-ND
- (1) LM317LZ voltage regulator, Digi-Key 497-1573-5-ND
- (1) 240 ohm 1/4 Watt resistor, Digi-Key 240QBK-ND
- (1) 5K board-mount potentiometer, Digi-Key 490-2983-ND
- (1) 25mm x 50 mm circuit board, PCB, or perf board

The schematic for the full circuit can be seen in [1].

## SETTING IT UP ON PERF BOARD

You can build this circuit on a small piece of perforated board (“perf board”). Insert the component leads through the holes in the board and bend them slightly to secure the components in place. Use canopy glue to hold the potentiometer.

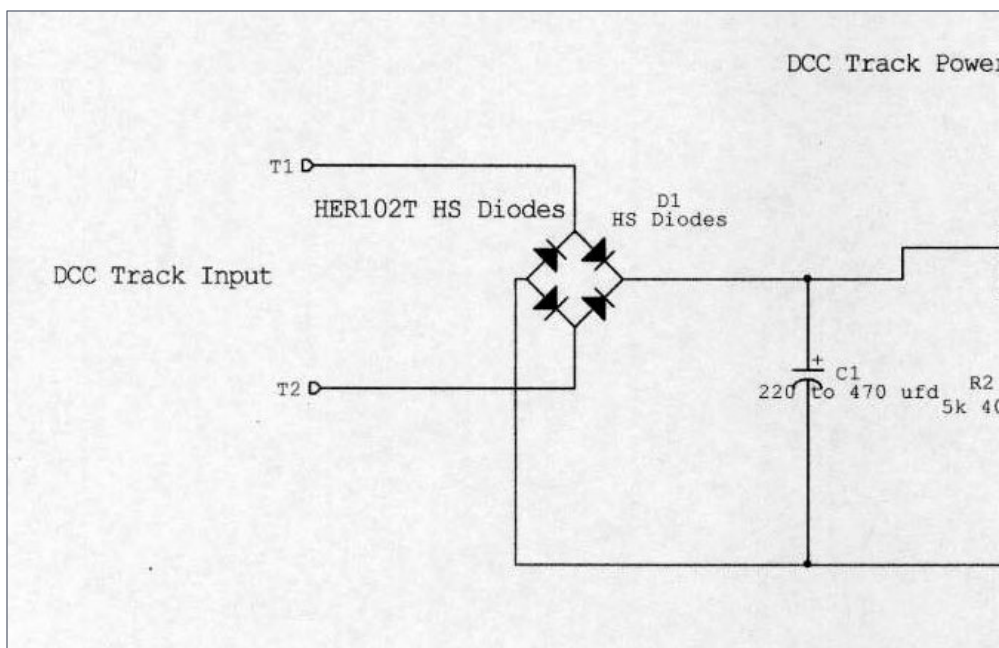

REGISTER  
(free)

[INDEX](#)

[TABLE OF CONTENTS](#)

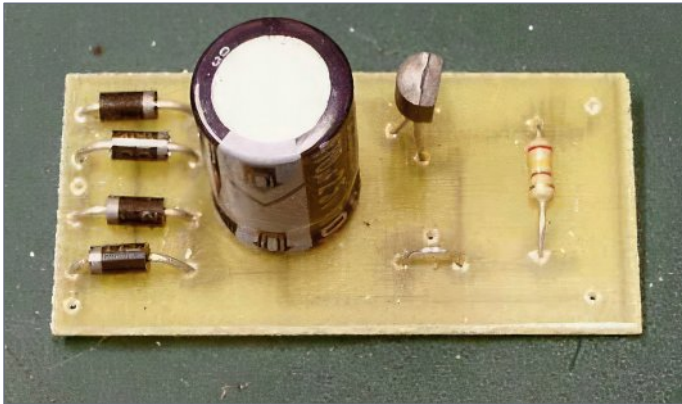

2. Here are photos of a finished circuit board wired for 1.25 VDC output for use with the 1.5 VDC blubs.

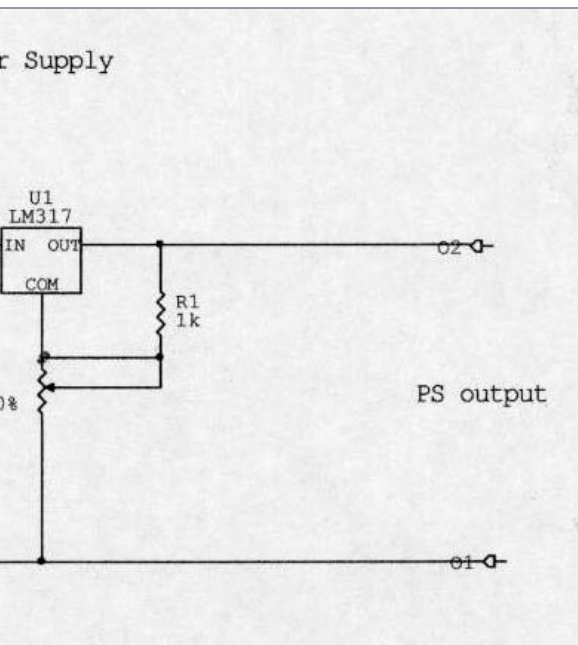

1. The circuit schematic.

## HOW TO MAKE YOUR OWN CIRCUIT BOARD

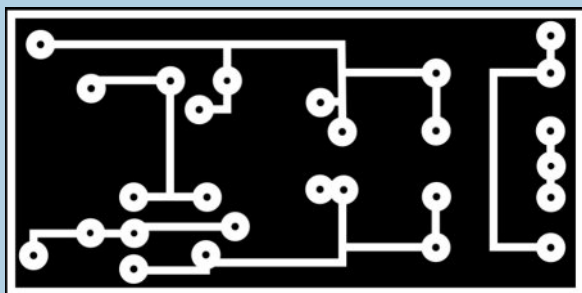

3. Full-size negative artwork for the 1x2" circuit board.

By Michael Dodd

A printed circuit board (PCB) is the best option to install and connect components for an electronics project, especially if you need several copies. Here's what you need to know to make your own.

### The basic process

A PCB starts with a material known as *copperclad*, which is a fiberglass (most common) or phenolic substrate with a thin layer of copper bonded to it. Be sure to use boards with copper on only one side ("single-sided"), not double-sided boards with copper top and bottom.

A wiring *layout* is applied to the copper to create a resist pattern. Then the board is immersed in *etchant* that dissolves the copper everywhere there is no resist, leaving just the wiring.

After etching, the board is washed and scrubbed to remove the resist from the copper traces.

When dry, holes for component leads are drilled, and the PCB is ready for parts.





# Home Field Advantage



Did you know that SoundTraxx keeps our manufacturing domestic by designing and building all of our decoders at our facility in Durango, Colorado? Since 1990, we have been committed to crafting quality products, strengthening our national economy, and creating local jobs.

When you buy SoundTraxx decoders, you support building American-made goods and get the industry's best customer support. And our products aren't just good – they're excellent!

**SOUNDTRAXX**  
www.soundtraxx.com

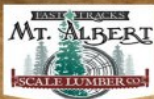

Introducing

THE

# LUMBER STORE



## ROTATING STORAGE RACK

On its own, or fully loaded with Mt. Albert Scale Lumber!

[handlaidtrack.com](http://handlaidtrack.com)

1-888-252-3895



ESU

Close enough, is no longer good enough

LOK  SOUND  
EST. 1999

- High Fidelity Sound Quality
- Superior Motor Control
- Overflowing with Lighting Outputs
- Ultimate Variety of Sounds

[www.loksound.com](http://www.loksound.com)



REGISTER  
*(free)*

[INDEX](#)

[TABLE OF CONTENTS](#)

## Etchant

Copperclad is etched using *ferric chloride* (most common) or *ammonium persulphate*. Ferric chloride etches slower, and leaves a dark orange stain on everything it touches. Ammonium persulphate is clear.

## Layout

Usually an article (like this one) will include a black-and-white image of the PCB wiring layout for you to photocopy or print. Read the next section to learn how to apply it to the copperclad board.

First be sure of two things:

- Is the layout “positive” or “negative?” The pattern applied to the copperclad must be etched so the wiring traces and pads remain, and are not etched away! Follow the instructions for the method you’re using (next section).
- Is the layout correct for the “wiring” side of the PCB. Usually components are mounted on the top of the PCB, with the wiring on the bottom, but this isn’t always true. Inspect and understand the layout before you proceed.

## Applying the layout to the board

There are several methods to apply the wiring layout to copperclad board:

- **Photo negative.** Lay a black-on-clear negative on copperclad that is coated with a layer of resist sensitive to ultraviolet (UV) light. Hold the negative in place with a sheet of glass, and expose to a UV light for several minutes, or to direct sunlight for 20-30 minutes. Then “develop” the resist by immersing it in a special solution, and rubbing gently with a small sponge. The resist that

## HOW TO MAKE YOUR OWN CIRCUIT BOARD *CONTINUED ...*

was struck by UV light remains, while the remainder dissolves away.

Instructions for exposing and developing should be included with the photosensitive copperclad. They're usually inside the light-tight plastic holding the copperclad.

The author of this article used a laser printer to print **two** copies of the layout onto transparent overhead projector material, then stacked them together on the copperclad. This technique reduces light transmission through not-quite-opaque toner on one sheet.

Photosensitive copperclad has become hard to find. Mouser Electronics lists several on this page: [www.mouser.com/c/tools-supplies/prototyping-products/copper-clad-boards/?b=MG%20Chemicals&product=Pre-Sensitized%20Boards](http://www.mouser.com/c/tools-supplies/prototyping-products/copper-clad-boards/?b=MG%20Chemicals&product=Pre-Sensitized%20Boards).

- Iron-on. All Electronics sells Techniks Press and Peel material: [www.allelectronics.com/item/tek-5/techniks-press-peel-pc-board-kit/1.html](http://www.allelectronics.com/item/tek-5/techniks-press-peel-pc-board-kit/1.html). You use a photocopier or laser printer to transfer your layout to a special film, then *iron the design directly onto the copperclad*. Peel off the film, and the board is ready for etching.

This method eliminates the hassle of exposing and developing photosensitive copperclad. Plus, bare copperclad is more readily available than the photosensitive version.

- Resist pen. For simple circuits, you can simply draw your own wiring layout directly on bare copperclad using a pen whose ink is resistant to the etchant. Sometimes a Sharpie permanent marker works, or you



Make LocoNet wiring extremely simple!



**PM42**  
breakout  
board



**BDL168**  
Multi-zone  
breakout board



**SE8C**  
breakout  
board



**BDL168**  
Single-zone  
breakout board



Now Offering SNAPS! in packs of 6 or 12 pieces! [CLICK TO LEARN MORE ...](#)

**TamValleyDepot.com**



Home of the  
Frog Juicer

**Dual  
Frog Juicer**



Automatic DCC Polarity  
Reverser can be used to:

- Power Two Frogs
- Crossovers
- Crossings
- Automatic Reverser for  
Turntables
- Wyes, Loops
- Circuit Breaker

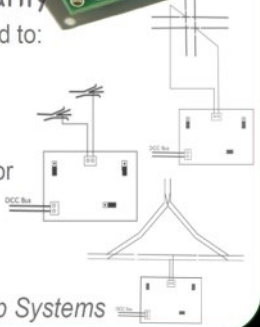

Use with 2-10 Amp Systems



Experience a revolution in  
trackside sound!

Coming **this** July.



Iowa Scaled Engineering  
[iascaled.com](http://iascaled.com)



**S T A T I O N**

*We carry your favorite DCC products!*

**NCE | Digitrax | Speakers | RailPro**

**SoundTraxx | Train Control Systems**

**ESU LokSound | Tam Valley Depot**

**[www.LitchfieldStation.com](http://www.LitchfieldStation.com)**

**[sales@litchfieldstation.com](mailto:sales@litchfieldstation.com)**

**623-298-7355**



**REGISTER**  
*(free)*

[INDEX](#)

[TABLE OF CONTENTS](#)

can buy pens with special ink for this purpose. Search eBay for “Anti-etching PCB Circuit Board Ink Marker” to find these. (Read carefully; most I’ve seen ship from overseas, and shipping might add to the cost.)

## **Etching and cleanup**

Search the internet for articles on making your own PC boards, and read about how to use your etchant of choice.

***Cover work surfaces and wear eye protection and nitrile gloves when using either etchant.***

Be sure to wash the board thoroughly when done, then scrub it gently with fine steel wool to remove the resist and leave clean bare copper suitable for soldering.

## **Drilling**

The final step is to drill holes for component leads. Fiberglass dulls regular drill bits rapidly, so consider buying carbide bits designed specifically for PCB material. An eBay search for “carbide bit pcb” will turn up dozens of listings showing 50 bits for about \$15.

You can use a pin vise to drill holes (slowly) by hand, or chuck the bit in a motor tool (e.g., Dremel). Secure the PCB so it doesn’t slide, and drill from the wiring side through to the non-copper side.

Use fine sandpaper to remove copper burrs after drilling.

## **Conclusion**

Making PCBs is a multi-step but straightforward process. You decide if it’s worth the effort, based on the number of boards you need. ■

This little power supply on a circuit board will easily fit into an HO scale caboose or passenger car. Have fun! ☑

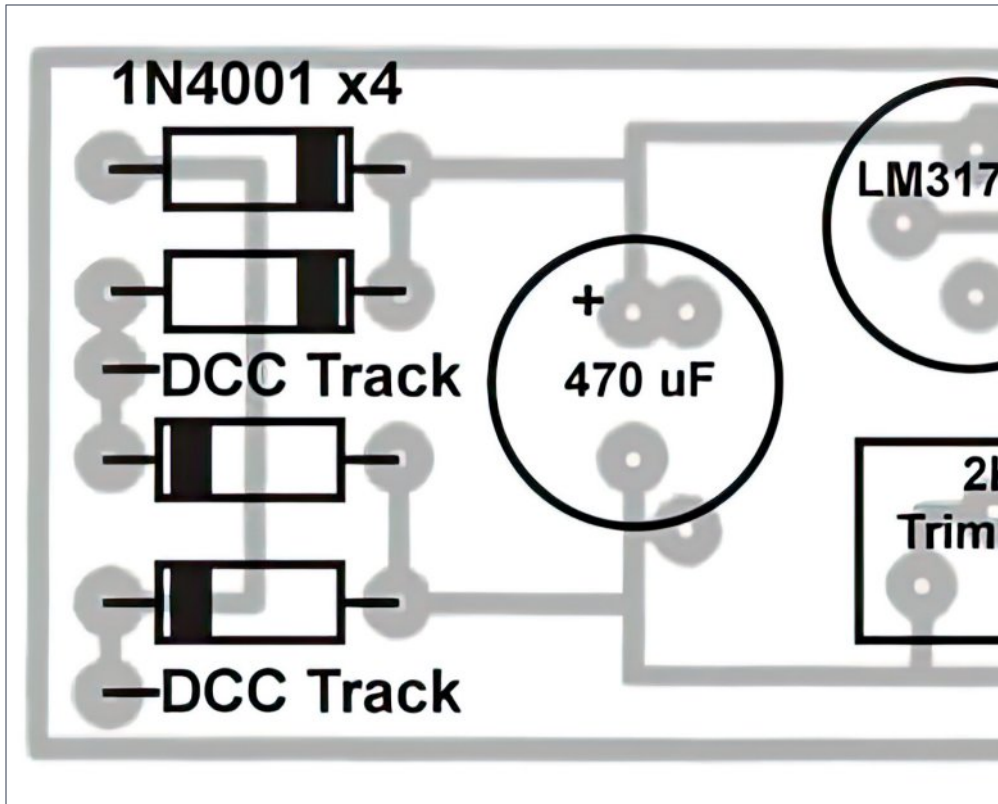

4. Component layout for the circuit board.



## RICHARD NAPPER



*Sadly, Richard Napper passed away a few years ago. This article is still quite*

*useful, so we're publishing it in memory of Richard's love of the Frisco and his passion for our great hobby. Thank you for giving back to the hobby, Richard; you are missed! ■*

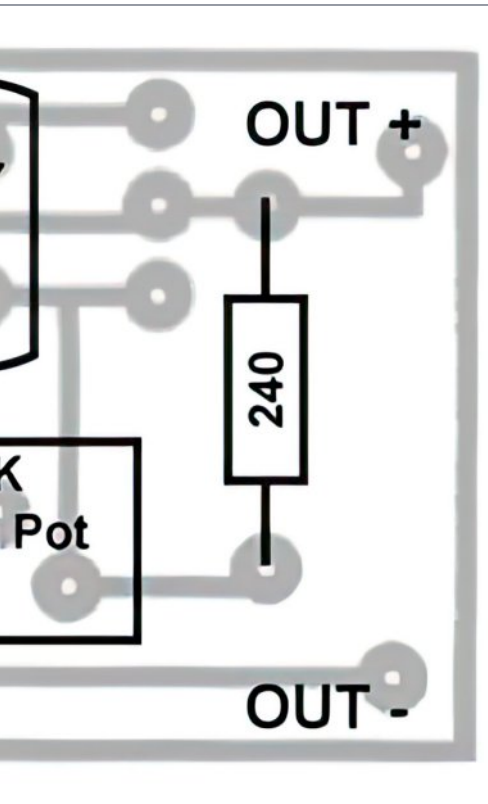

Get more articles like this

GIVE IT A LIKE



# From first train set to railroad empire...

*Our complete line of DCC products  
grows with you. Discover the fun!*

- Designed and manufactured in the U.S.A.
- Preferred for ease of use and ergonomic design
- Unlimited scalability for any size model railroad
- Plug-and-play means more time running trains
- Great customer service and excellent support



## See your dealer



REGISTER  
*(free)*

[INDEX](#)

[TABLE OF CONTENTS](#)



## Visit our new and improved web site for all your DCC needs!

- Get the latest new product announcements
- Watch our detailed how-to videos
- Browse the all-new Information Station
- Enjoy secure online sales, day or night!

Visit **ncedcc.com**



# MRH MARKETPLACE



## CROW RIVER PRODUCTS



### "O" SCALE KIT 337

#### STEAM POWERED THREE DRUM WINCH

Provides Three Lines For Clam Shell Buckets Etc.

On Board Two Cylinder Steam Engine.

This Winch will be included in our upcoming Dredge Kit

"O" Scale Kit 338 Due out this Fall

Price 70.00

Made in USA

HO & O Scale Machinery, Derricks,  
Engines, Hardware & Waterfront Models  
Pawtucket, RI 02861 Tel 401-723-0065  
[www.crowriverproducts.com](http://www.crowriverproducts.com)

## REAL TRACK SCALED DOWN!

Home of the only prototypically accurate  
Turnout Kits, Fixtures and Track Parts for HO  
and Proto:87.

Scale Spikes, Tie Plates, Real Wood Ties and  
Bulk Rail in codes 83, 70, 55 and 40

[PROTO87.COM](http://PROTO87.COM)



[BackdropsOnly.com](http://BackdropsOnly.com)

At Checkout Enter code MRH-20

To Get 20% Off All Backdrops

[CLICK HERE FOR BACKDROPS](#)

[BackdropsOnly@gmail.com](mailto:BackdropsOnly@gmail.com)

or Call 800-320-5057



REGISTER  
(free)

[INDEX](#)

[TABLE OF CONTENTS](#)



**REVOLUTIONIZE THIS**

**O-HO-N SCALES**

**CLICK HERE**

**PROMO CODE TENOFF**



**Squeaky's Trains**

10% Off Sitewide! Use Coupon Code MRHQ223 at Check Out!

(Certain items & S/H excluded)

Let's play with trains!

Offering:  
Walters, SoundTraxx, NixTrainz, RailPro, Woodland Scenics, Bar Mills, and many more Railroadng Supplies!

**SqueakysTrains.com**



**WEATHERING POWDER**

**MONROE MODELS**

**www.monroemodels.us**



*click to learn more!*

**East Coast Circuits**  
Innovating Your Model Railroad Layout

**ECU**

P.O. Box 25412  
Providence, RI 02905

Lighting Circuits For Your Layout

Random Lighting Circuit - Burning Fire Circuit  
Traffic Light Circuit - Crossing Signal Circuit

Custom Lighted Vehicles  
HO & O Scale Emergency Vehicles  
HO & O Scale Trucks & Cars

Eastcoastcircuits.com      Eastcoastcircuits@gmail.com

Come visit our booth in Grapevine, TX at the National Train Show (Aug 25-27)

Product demos and show discount!

Please visit our website and online store!

**LOGIC RAIL™ TECHNOLOGIES**

info@logicrailtech.com      (281) 251-5813      www.logicrailtech.com



**PRECISION DESIGN CO.**

**CUSTOM DECALS FROM YOUR OWN ART IN JUST ONE DAY**

**PDC.CA**

FULL COLOR & SOLID WHITE

**W** GOLDEN AGE LINE

**WESTERFIELD**

MODELS, LLC

**NEW KIT: 11001 N&W BATTLESHIP GON**



**ALSO X23/R7 LADDERS**

**westerfieldmodels.com**

## **ITLA** 10yrs **Scale Models Inc.**

**Laser Cut Wood  
Kits**



**Modular Designs  
Multiple Footprints**

CLICK TO VISIT OUR WEBSITE ...  
[www.itlascalemodels.com](http://www.itlascalemodels.com)

**THE N-SCALE DIVISION** Since 1992

Top Quality **N-SCALE** Discount Prices

American - European - Japanese - DCC/Sound

**KATO**  
PRECISION RAILROAD MODELS

**MICRO-TRAINS**  
LINE

**Fleischmann**

**TRIX**

**ESU**

**SOUNDTRAXX**



**HUGE SALE ON ALL ATLAS FREIGHT CARS**  
100's TO CHOOSE FROM - SHOP US TODAY!

[nscaledivision.com](http://nscaledivision.com)

**Model Railroad Control Systems** Geoff Bunza Project Boards • DCC Occupancy Detectors  
CMRInet Compatible Nodes • Layout Telephone Systems • RFID Switchlist Generator • Switch Machines and Drivers



**PRE-SIZE**  
MODEL SPECIALTIES

P.O. Box 6 Paonia, CO 81428  
Ph. 970 527 4586  
Made in The USA

Cast resin items for All Scales.  
Tunnel portals, bridge piers, abutments,  
culverts, and retaining walls.  
Trackside details and sage brush tree  
armatures.

"FREE SHIPPING see website for details"

**WE'RE BEHIND YOU ALL THE WAY**

**Sceniking**.com  
*...nothing compares...*  
Click to learn why!

## **Great Decals!**<sup>TM</sup>

FEC, Interstate, Virginian  
Railway, & L&N Titles  
After Hours Graphics Line  
Coupler Gages and More  
In O, S, HO, and N Scales



**MONASHEE** **CLICK HERE**  
**LASER**  
**ENGINEERING**  
MANUFACTURING RAILROAD  
STRUCTURES. **FALL SALE** STOCK MODEL KITS



**REGISTER**  
*(free)*

[INDEX](#)

[TABLE OF CONTENTS](#)

INTER-ACTION  
Hobbies

ZOLTAR  
SPEAKS

Your  
Wish is  
Granted!



Kit O-5037

[www.interactionhobbies.com](http://www.interactionhobbies.com)

The image shows a colorful, ornate Zoltar Speaks kit. It features a central figure of Zoltar, a character with a large, ornate headpiece and a mustache, set within a decorative frame. The frame is topped with a golden dome and has intricate patterns. The background is a dark, textured surface.

Please  
tell your  
buddies  
about us!

Hobby Marketplace  
Ads are Economical  
and Effective.

*Click to learn more ...*

WE RELY ON WORD-OF-  
MOUTH TO GROW AND A  
BIGGER CIRCULATION  
MEANS MRH IS MORE  
LIKELY TO STICK AROUND  
FOR A LONG TIME TO  
COME!

LOOK  
at what's new at  
Black Cat this month

Click here for  
our website

CPR 3 D printed  
CPR 36' DS box car kits  
by twenty Models includes  
castings, etchings & decals



Black Cat Publishing  
(204)489-5005  
[ajfergus@mymts.net](mailto:ajfergus@mymts.net)  
[blackcatdecals.com](http://blackcatdecals.com)



The image shows a brown CPR 36' DS box car. The car has "CANADIAN PACIFIC" and "CPR 161057" printed on its side. It is a detailed model of a freight car, shown from a side-on perspective. The background is a plain, light-colored surface.



# Mike Armstrong's Rock Island

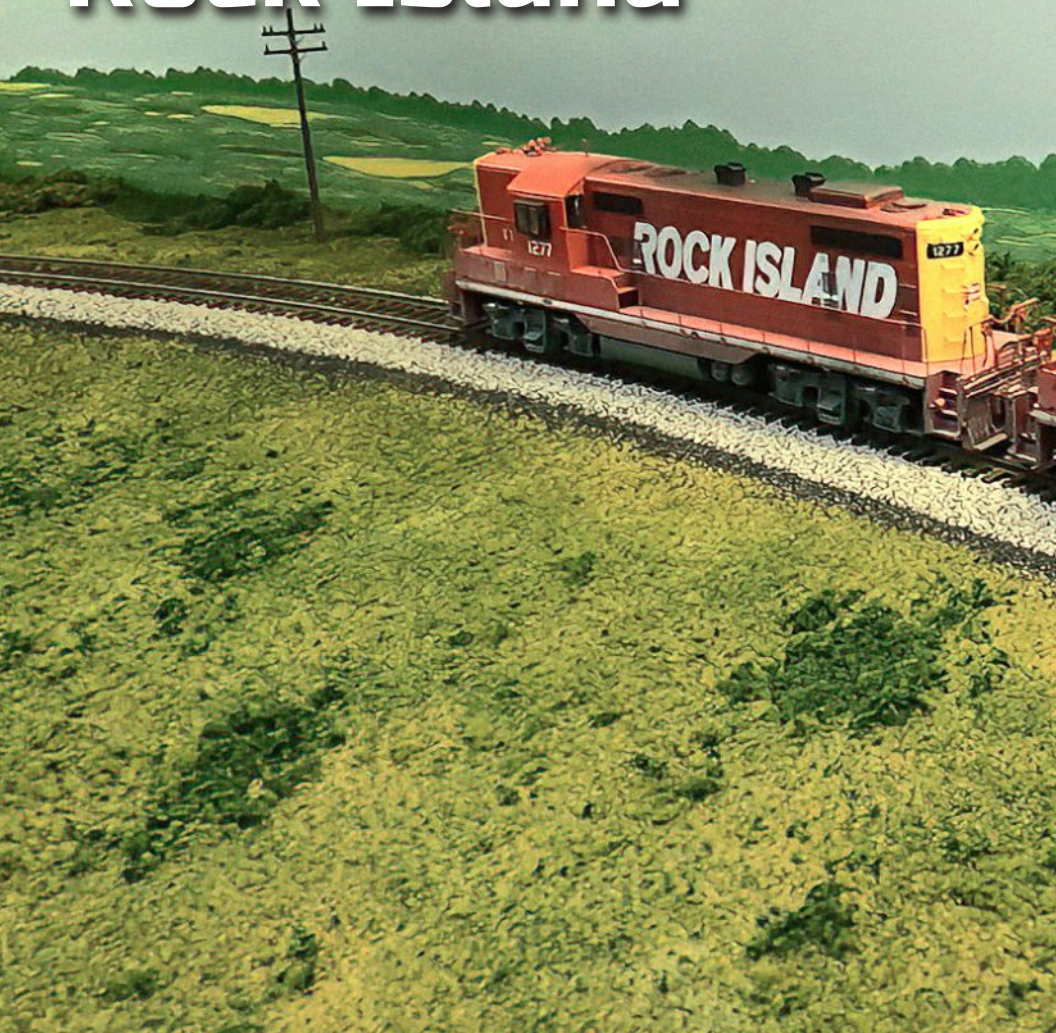

JOE FUGATE VISITS THIS DOUBLE-DECKED  
DALLAS/FORT WORTH AREA LAYOUT ...



REGISTER  
*(free)*

[INDEX](#)

[TABLE OF CONTENTS](#)





1. One of the outstanding aspects of Mike Armstrong's Rock Island is the way he has captured this iconic Midwest railroad. Rather than jam the room full of track, Mike used a lot of "negative space" to give the trains some decent running distance between towns.



**MIKE ARMSTRONGS' LAYOUT IN THE GREATER DALLAS/FORT WORTH AREA WILL** be open for tours during August 2023 as part of the 2023 Texas Express NMRA National Convention. To learn more about this convention and/or to register, please visit this website: [2023texasexpress.com](https://2023texasexpress.com)

I visited Mike and toured his layout in late February 2023, taking photos and video. We sat down and talked about his journey in the hobby and the process of designing and building his fascinating HO scale layout.

**MRH: Mike, how did you get started in the hobby?**

**Mike Armstrong:** I've been interested in model railroading for as long as I can remember. I got an HO train set at age six, which was my first introduction to the hobby. And it just grew from there.

I've had model railroads my entire life. The first four weren't much to look at because I built them in my pre-teen and teen years. The ones after that just got better and better. So, I've always had an interest in model railroading.

**MRH: What layout number is this, then?**

**Mike:** This is layout number eight.

**MRH: That's a good number of layouts, so you have a lot of hobby experience under your belt. Tell us more about that journey.**

**Mike:** I had model railroads when I was in junior high and high school. Then it was off to college, and I didn't have a layout during those years. After that, I started my career with the railroad.





2. Mike's layout fills a roughly 30x40-foot space with two decks. A helix on each end connects the decks. The lower deck is at about 40 inches off the floor, and the upper deck is about 20 inches above that, at 60 inches.

I started with the Burlington Northern, and early in my career I moved around quite a bit, so I wasn't able to establish a layout. But by the time we moved to Kansas City in 1986, I was able to build a basement layout of sorts.

When we relocated to Denver, I built a layout in Denver. Then when we relocated to Texas, Texas doesn't have basements, but we did have a third stall of a garage that was 10 by 20, and I built a layout there.

A few years ago, we moved into this home we're in now, and I built what I call my retirement project.

**MRH: Tell us more about this current layout space.**

**Mike:** I model the Rock Island railroad from Minneapolis-St. Paul to Kansas City, running over that territory on two levels.

Somebody walking into the layout room will see a 40-inch lower level and a 60-inch upper level. As you walk around the room looking at the layout, you'll notice that those two levels remain separated by about 20 inches all the way around the room until they get to the helixes.

On either side of the entranceway sit two helixes. Those helixes take the train from one level to the next level.

**MRH: What's the radius of the helixes? What's the grade and how many tiers in them?**

**Mike:** I have the two helixes, and both have two tracks in them. One track is 73" diameter (36.5" radius), the other track is 67" diameter (33.5" radius), and they're both identical. The grade within the helix is approximately 2%. It does get just a tad bit sharper as you exit the helix, but I call it a 2% grade.

There are four turns (five tiers) to get the train from one level to the next.



3. While Mike's layout is basically flat, he does have the occasional cut, slight fill, or bridge over a river bed. The track remains essentially flat, but the terrain undulates here and there.





## **MRH: Why the Rock Island?**

**Mike:** I grew up on the Rock Island in central Iowa in a little town called Nevada (pronounced, Nuh-vay-dah). That was in the 1960s when the Rock Island was a going concern. We had a couple of passenger trains each way per day through town. Freight also came through Nevada – the town had an active station with an agent that handed train orders up to the trains!

This all really left an impression on me, and I saw the Rock Island as a really neat railroad. Sadly, it no longer exists, but I want to memorialize it with my model railroad.

I'm modeling what's known today as the "spine line." The Rock Island called it the Mid-Continent route, and it ran from Minneapolis-St. Paul all the way down through Kansas City to Houston and Galveston.

I model the Minneapolis-St. Paul to Kansas City portion.

**MRH: Interesting. The Layout Design Special Interest Group (LDSIG) has found often the most satisfying layout comes from modeling the prototype that got you interested in railroading as a kid.**

**Mike:** That's certainly how it worked for me.

**MRH: Are you freelancing, proto-freelancing, or faithfully modeling the prototype? How true to the prototype is your layout?**

**Mike:** I'm trying to model the prototypical the Rock Island, realizing that a number of the scenes in the towns aren't exactly the way the town was laid out. The stations that Ollie Millhouse built are spot-on accurate.

Given the compressed space that we have to work in, it isn't exactly as the eye would see it on the real thing. One scene I have tried to stay fairly true to is at Clear Lake Junction, where the Iowa Terminal Railroad crosses the mainline – which is actually the Chicago Great Western at that location [14, 15].

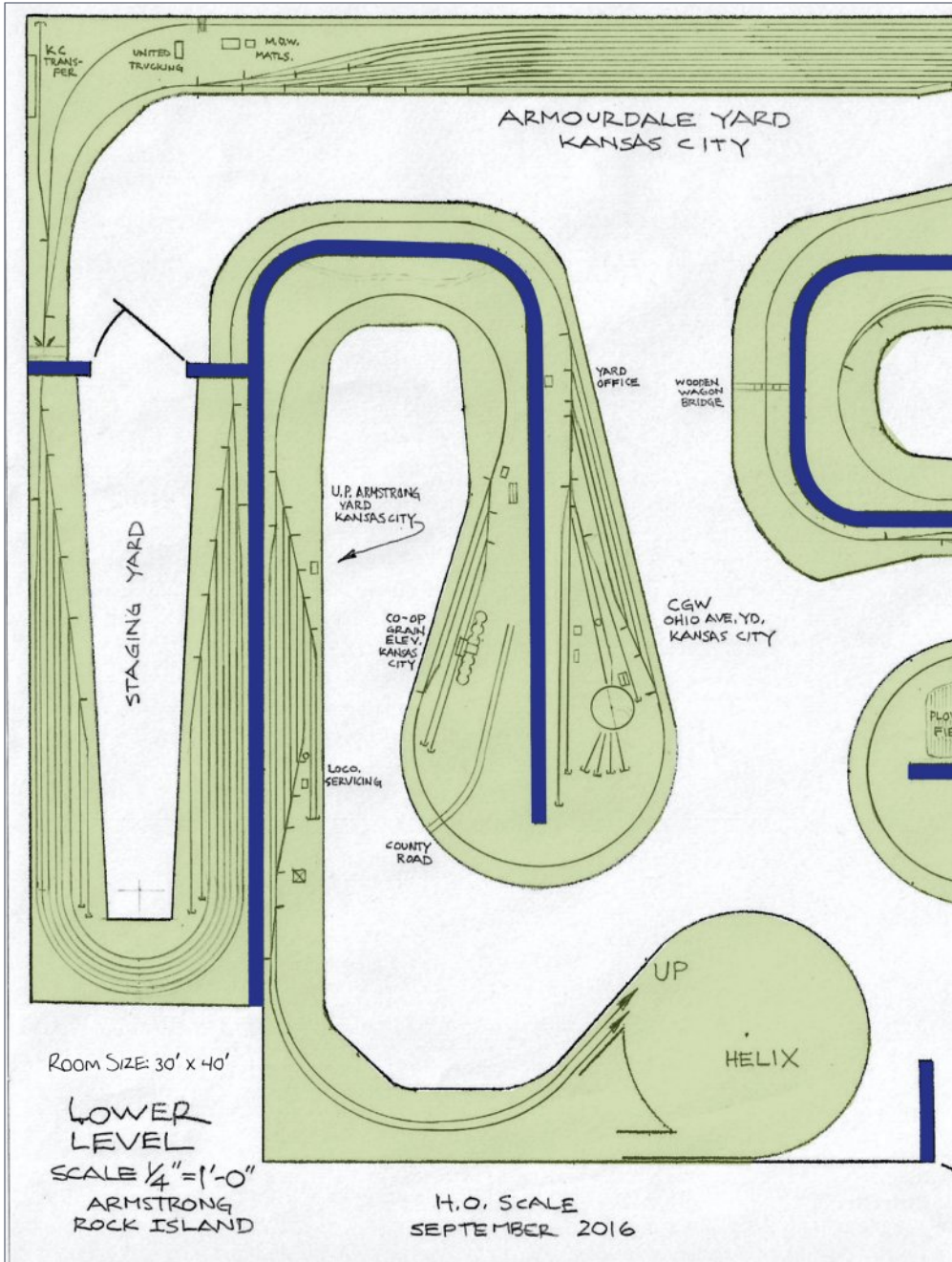

REGISTER  
(free)

[INDEX](#)

[TABLE OF CONTENTS](#)

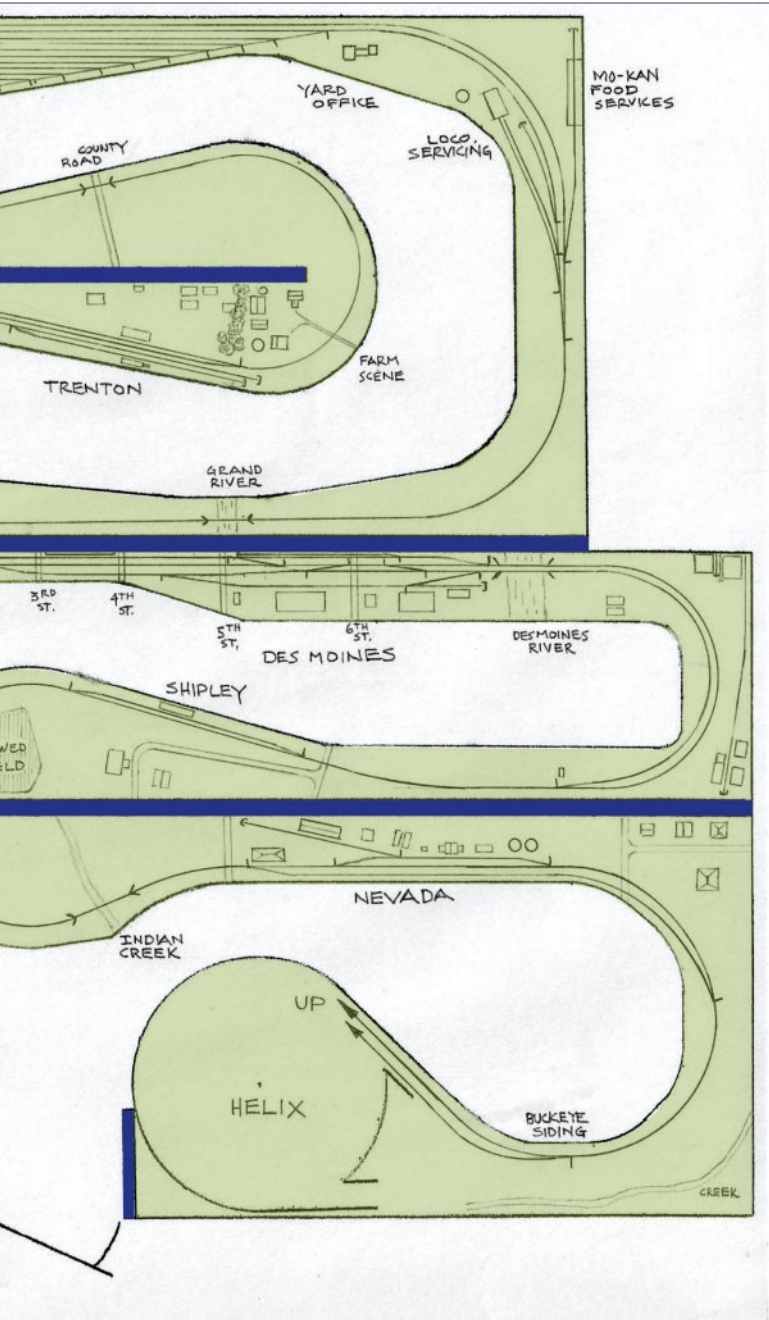

4. Track plan for the Rock Island lower deck (nominal height, 40").



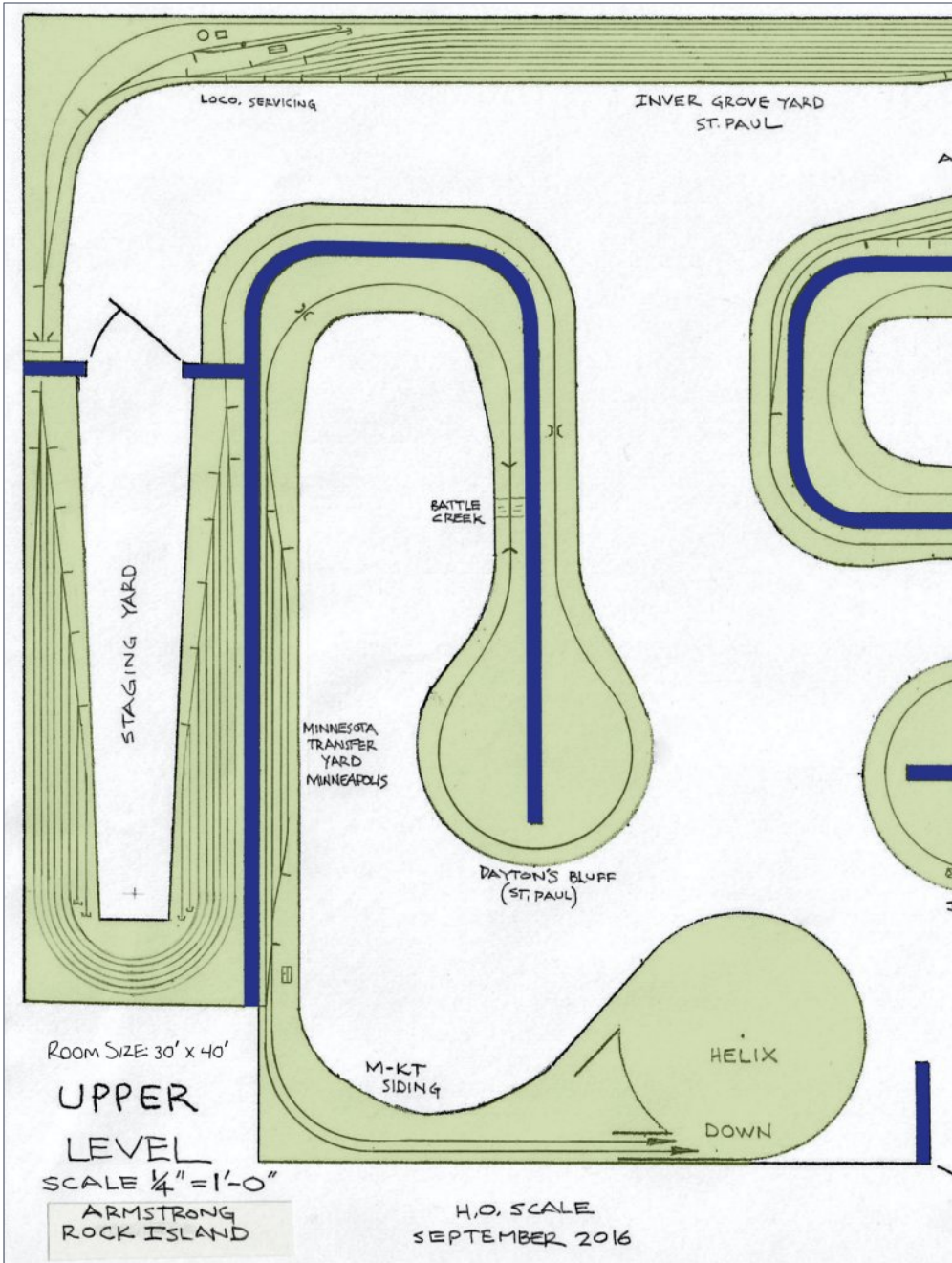

REGISTER  
(free)

[INDEX](#)

[TABLE OF CONTENTS](#)



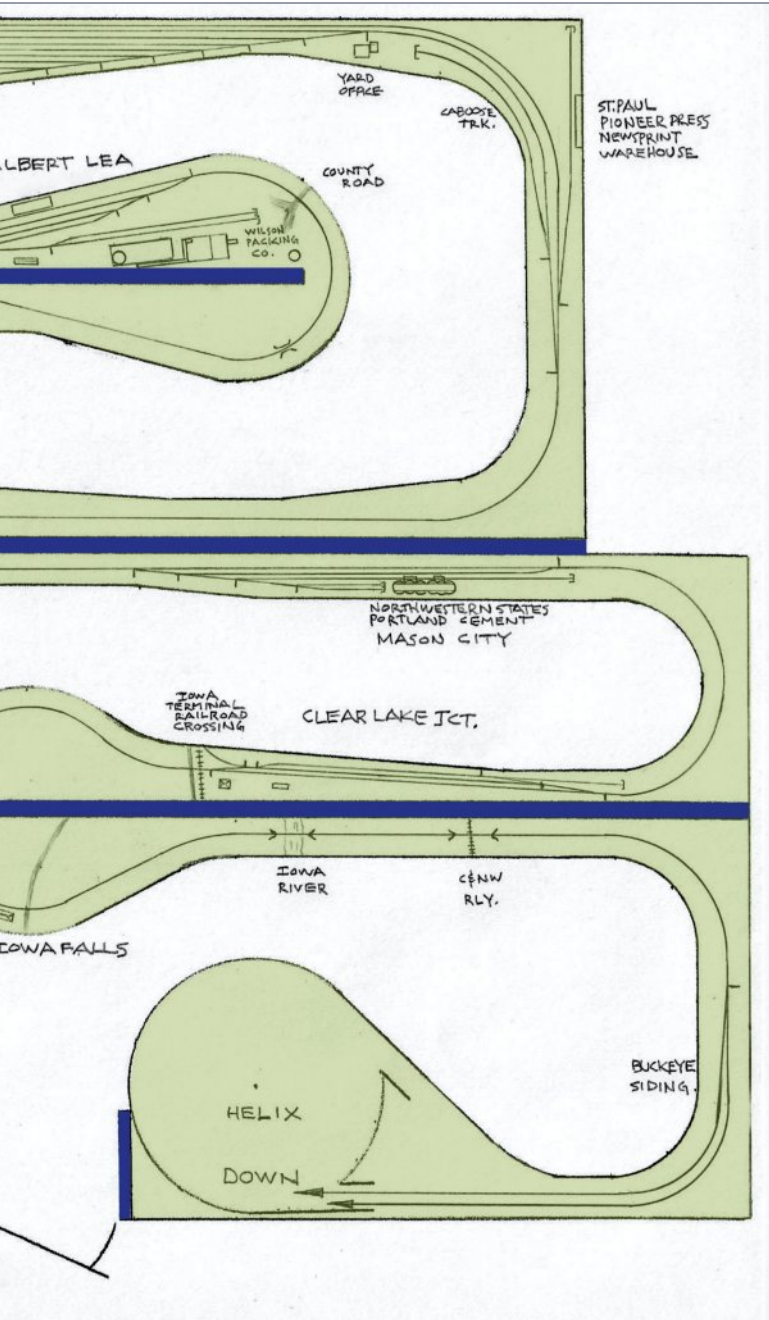

5. Track plan for the upper deck (nominal height, 60'').



The Rock Island had trackage rights over the Chicago Great Western, and I tried to model that little scene as accurately as possible. And I did the same thing at Nevada, Iowa, because I grew up there, so I'm very familiar with that.

I've tried to accurate, but it's not a hundred percent, that's for sure.

## **MRH: So how did you develop your track plan?**

**Mike:** I started with the room dimensions when we built our home. I designed the interior walls so the builder would finish the layout space walls. I had a pretty good idea what I wanted to do for a track plan.

I recall seeing in the pages of *Model Railroader* David Barrow's layout down in Austin, Texas. I always admired the configuration of his model railroad – the way it used peninsulas and how the track made its way around the room.

I took David's concept and applied it to my model railroad, deliberately designing the track routing to give me long open runs between towns. Because I had a good idea of what I wanted up front, the track plan just kind of flowed into place.

## **MRH: When did you start construction?**

**Mike:** We built our home in 2007, moved in that August, and I started construction in the fall.

I started with the helixes, which I figured would be the most difficult part. I built those right away and then continued around the room from there. I pretty much had the layout to a point I would call complete by the 2015-16 time frame.

So, there was a nine-year period when I diligently worked on the layout to get it to the point where it became a fairly complete model railroad.

**MRH: Did everything go as you expected, and did it progress as fast as you wanted?**





6. A train rolls into Nevada (nuh-vay-duh), Iowa, Mike's representation of the small town where he grew up. The kid on the bicycle in front of the depot is Mike.



7. As the train rolls on through Nevada, the signal drops from green to red. Compare the signal here to [6].

**Mike:** I've built several layouts before, and this is layout number eight. The other seven layouts were a springboard to this one because I learned many lessons about what to do and what not to do.

One of the things I picked up on with my last layout was soldering. I was never any good at soldering. I finally used my last layout to help me hone those skills, preparing me for when I built this larger layout.

It's amazing what you learn on your previous layouts. The one thing I would tell my fellow modelers is, do not get frustrated when building a layout. There may be more to follow, and you'll just get better and better as you go.

When I built this railroad, things went pretty well for the most part. I didn't hit many glitches. I had learned enough on my other layouts that I had a solid plan for this one.



8. One of the clever aspects of Mike's scenery is how he often it slopes down from the railroad. This simulates the fill the track is laid on, which is often the highest thing for miles in the flat Midwest.



REGISTER  
*(free)*

[INDEX](#)

[TABLE OF CONTENTS](#)





9. Mike has several bridges on his layout, most crossing streams, rivers, or roads. This one, however, crosses the Chicago & North Western rail line along the Iowa River.

I knew exactly what I wanted to do, and things progressed well, schedule-wise. I pretty much hit the time frame I wanted to for completion.

I enjoyed the construction portion, cutting and placing the lumber – that’s probably one of my favorite parts of construction. The electrical was fun too as it got the trains running, but I don’t enjoy the electrical as much as I do the woodworking portion.

**MRH: Your extensive layout-building experience speaks to a concept we call the *chainsaw layout*. Get started building – build something, gain that layout building experience as soon as you can, *don’t wait*.**

**As you found, with seven layouts under your belt, by the time you got to number eight, it came together smoothly. You knew what you wanted and then you just went and did it.**

**Mike:** Yes, that's exactly right, that's just how it worked for me.

**MRH: What brand of track are you using?**

Mike: I used Micro Engineering code 83 on the main line and code 70 on the non-mainline tracks. I did use a little bit of code 55 as well. The code 55 has nice light profile that looks very realistic, but I was selective about where I used it.

I used Atlas Code 100 in both helixes and in the staging yard because those are portions people don't see much. They're not like the scenic portion of the railroad. So, I used a cheaper flex track there and have had good results with it.

I use Walthers turnouts for the mainline turnouts, and on the non-mainline turnouts, I use Micro Engineering turnouts, a very good product. The Micro Engineering are all hand-thrown using the built-in center-over spring, with just a couple of exceptions. I have a couple of non-mainline turnouts that are hard to reach, so I did power those.

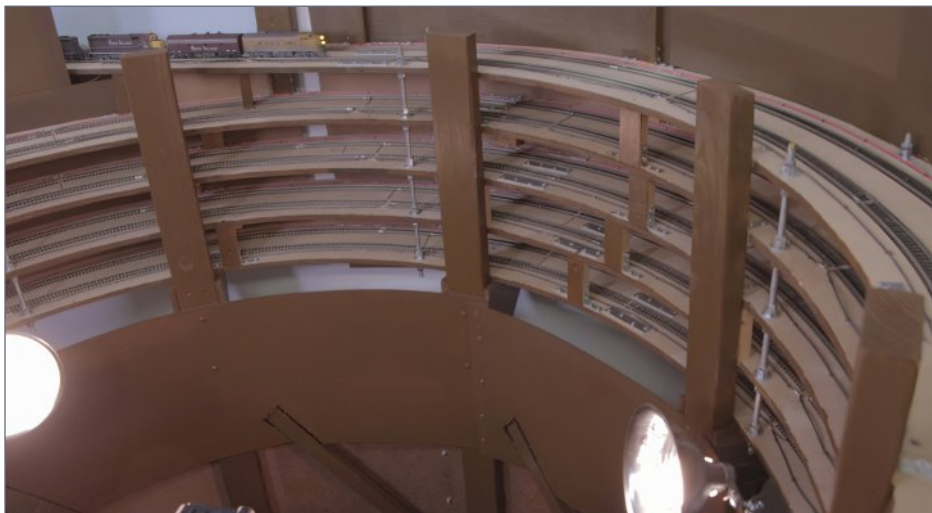

10. Mike has two five-tier helixes on his layout, one at each end of the run. The grade in each helix is about 2%.



REGISTER  
*(free)*

[INDEX](#)

[TABLE OF CONTENTS](#)

All the mainline turnouts (there are 67, I believe) are powered with the Tortoise By Circuitron. As for non-mainline turnouts, I don't have the exact number, but it's probably in the 70 range.

**MRH: That's interesting, because my Siskiyou Line layout was about half the size of your layout, and it had about the same number of turnouts. That says the maintenance load on my old layout and on your layout are probably very similar. How many feet of main line do you have?**

**Mike:** My main line run is 777 feet. But I have two large helixes, which eat up a lot of that run [*an estimated 170' by our calculation, leaving right at 600' of mainline run. - ed.*]

But there's a good bit of run in each helix – the train disappears for several minutes in those helixes. So anyway, that's what I've got for mainline trackage.

**MRH: What's the ruling grade? Is it in the helix?**

**Mike:** Yes, the ruling grade is in the helix, and that's a 2% grade.

On the visible portion of the layout, I have two locations where I have incorporated a very slight grade. Some 98% of the visual portion of the layout is flat.

However, I do have 0.6% grade in two locations. One is a sag and the other is a crest, and they're very discreet. If you look down the length of the peninsula, you can see the grade. But just standing and looking straight at the layout, you don't really see it.

A 1% grade on a real railroad is one that's starting to pull hard. So, a 0.6% is not a little grade. Any grade on a real railroad is a big deal. The 2% for me in the helix was as rough as I wanted to go.

**MRH: What would you say the greatest challenge was in doing this layout?**

**Mike:** The greatest challenge for me building this layout was the ballasting. It was a large effort, and it took me several tries to get a process I liked. I say that because I like ballasted track to look fairly clean, and it took a while to get a method that worked for me.



11. Mike runs a train through Nevada, Iowa on the lower level. Mike grew up in Nevada, and his layout keeps his memories of the Rock Island in the region alive when it was still a vibrant railroad.

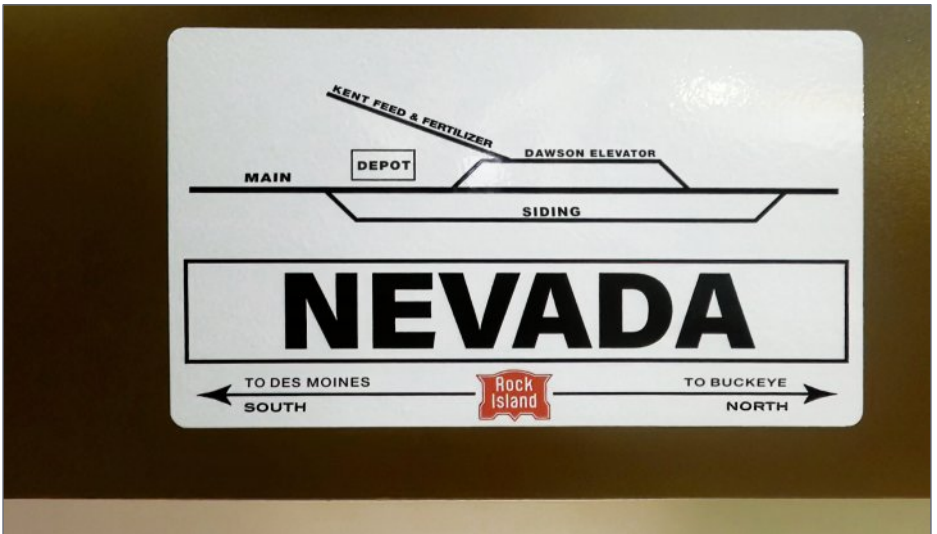

12. Each of the layout towns has a nicely formatted and informative sign such as this one at Nevada [11].



REGISTER  
*(free)*

[INDEX](#)

[TABLE OF CONTENTS](#)



But once I got into a rhythm, I could do a six-foot stretch, for example, in an evening. But the ballasting was just a tedious process.

**MRH: Even though things went quite well for you in building the layout, were there any surprises, anything that you didn't anticipate?**

**Mike:** Putting up the backdrops on my two main yards – Inver Grove Yard in St. Paul and Armourdale Yard in Kansas City – caught me off-guard. I used a backdrop scene offered by Scenic King, who makes very nice backdrops.

I had studied the methods for applying the backdrop scene to the wall. A lot of people just trim it to size, spray the back, and then put it in place.

I didn't have enough arms and hands to do that. Instead, I went through a process of rolling it out onto poster board to give it some rigidity, then glued it to the poster board. From there I could take the sections of poster board and apply the adhesive to the back, then set it in place.

This is the one thing that got my wife involved. I needed another set of hands, even when doing it this way. She helped me place those backdrops on the backside of my two major yards. That to me was a surprise and it took me a while to figure that one out.

You'd think it should be real simple, but it wasn't!

**MRH: What do you like most about this layout?**

**Mike:** I like that this layout has the capability to run continuous – this is possible because I have connected both ends of the staging yards on each level.

I like to come to the train room and start running a train, just relaxing, and watching it roll around the railroad. I like all the open spaces. I've tried to create negative space on the layout so long trains can just run through open country – and I get a lot of enjoyment out of that.



J. Fugate

## NEGATIVE SPACE

Mike mentions “negative space” in this interview – so what is this negative space?

Put simply, negative space is a layout scenery area that’s not crammed full of track, structures, and the like. In fact, it’s the reverse – there’s basically “nothing there” as far as the railroad is concerned. On a layout, it’s unused space in between scenic landmarks, layout design elements, and signature scenes. Rather than *adding* something “railroady” to the layout, it *takes away from it* per se, hence the term “negative” space.

Generally, you model negative space as the rural scenery that’s so typical of what real railroads run through. This space seldom gets modeled on many layouts because it’s seen as “wasted space” and we struggle already trying to find enough square footage to add all the scenes we want to our layouts.

Negative space scenes often get compressed out as part of the selective compression process when we plan a layout. It’s all that boring stuff between the interesting parts of a railroad.

Operationally, negative space has little value to a model railroad other than lengthening the run. It has no track – no industries; most typically “lots of nothing.” But putting one or more negative space scenes onto your layout can add realism because such “empty rural space” is 90% of what’s next to most real railroad tracks. When modeled well, a good negative space scene often becomes a signature area of a layout in its own right.

Mike has modeled a lot of “negative space” on his layout by putting a fair amount of rural space between towns. That not only lengthens the run, but lends a more realistic “feel” to a layout that’s modeling a Mid-western route like the Rock Island. ■





## 13. Two trains meet in M-K-T siding on the upper deck.

### **MRH: What do you like least about this layout?**

**Mike:** I'm least enthused about the lighting on the lower level. At the time, I installed the lower deck lighting back in the 2008-2009 time frame. LED lighting wasn't common, so I ended up placing some 99 of these 18" fluorescent under-cabinet lights beneath the upper level.

It works, but it's fluorescent lighting. What I have seen others do with LED lighting is much better. I am occasionally having to change out those fixtures and bulbs. At some point, I may just take it all out and put in LED lighting, but that's down the road, if at all.

### **MRH: If you had it all over all to do over again, would you do any of it differently?**

**Mike:** I don't think I would do anything differently. I do know people who have had good results laying the track right on the foam board. I've used three-quarter-inch plywood and some Homasote, and I've been pleased with that.

So, I don't know that I would do anything different. I'm very pleased with what I've come up with.

**MRH: OK. So how did you pick the deck heights?**

**Mike:** I established 40" for the lower and 60" for the upper. I did a little bit of research using Tony Koester's book on double-deck layouts. As I recall, the book said 17 to 20 inches is ideal for separation.

I just followed that recommendation and it has worked out well. My wife, however, doesn't care much for the upper level because it's a little high for her. She is approximately 5'-5", and I'm 6'.

But as I told her, I built the railroad for me, and she agrees with that. So, I established those levels based some testing I did, and on Tony Koester's book.

**MRH: So, what control system do you use and why?**

**Mike:** I use Digitrax, and the duplex wireless radio control. I have a command station and four boosters around the layout,



14. This is Clear Lake Junction, where the Iowa Terminal Railroad crosses Mike's modeled mainline. On the prototype, this is the Chicago Great Western mainline at this location – the Rock Island had trackage rights over the CGW here.







**15. Another view of Clear Lake Junction. Mike endeavored to model this as true to the prototype as possible.**

and I chose Digitrax about 2009. It was readily available and seemed to have a good track record. I have had reasonably good luck with that system.

**MRH: What kind of decoders do you use and why?**

**Mike:** I use mostly the SoundTraxx Tsunami decoders. I really like the Tsunami2. I have a few LokSound decoders as well. I find that the Tsunami decoders are very user-friendly, very easy to program.

When I go into JMRI and I speed-match locomotives, I find that the Tsunami and Tsunami2 especially are very nice to work with. Speed-matching and setting up the sound in JMRI with the Tsunamis is quite easy.

I use stay-alive in all my locomotives as well.

**MRH: Are you using SoundTraxx Current Keepers? You build your own, or are you using Train Control Systems?**

**Mike:** I've installed keep-alives in all my locomotives, and I really like the TCS Keep Alives. I have some SoundTraxx Current Keepers and have them installed as well. But primarily I use the TCS KA1, KA3, and KA4s. I really like the KA4s. They've been very reliable.

**MRH: What's your least-favorite part of working on a layout and how do you motivate yourself to do it anyway?**

**Mike:** I'd say my least favorite part of working on the layout is the electrical portion. The layout wiring is complete, and I don't really have too many electrical problems. I do pull maintenance occasionally on my signal system.

I'm finding that the signals drop occasionally as a kind of errant drop. I've done some research and found there's an electrical filter you can build using capacitors and resistors. You put it into a little harness, and then solder that onto the control circuitry of the signal. This seems to make for more reliable operation of the signal.

But my least favorite part of doing the layout is the electrical work.

**MRH: So, tell us more about your signaling system.**

**Mike:** I've got an ABS signal system. I have signals at nine locations, with two signals at each location for a total of 18.

I use Tomar target signals, and I use LogicRail electrical circuit boards for operating the signals. In my particular installation I'm using photocells, and I've placed the photocells such that the signal system reacts much like an ABS signal system would.

I also have operating grade crossing signals as well. I have a set crossing gates at Nevada that operate. I picked up those crossing gates many years ago and the outfit is no longer in business. They also use photocells. They've been reliable.

**MRH: Do the gates use Tortoises?**

**Mike:** No, the mechanism was provided with the gates. I don't recall the brand, and I believe the vendor is no longer in business.

**MRH: What are your thoughts on layout size, can a layout be too big?**





**16. Right up front at the south end of Inver Grove Yard is the caboose track. Since Mike models 1965-1974, cabooses are still in regular use on trains. In the back is the St. Paul Pioneer Press Newsprint warehouse.**

**Mike:** I think a layout can be too big in terms of being overwhelming to maintain. We often talk about completing a layout, and I'm proud to say I believe mine is pretty much completed. But it's never finished – there's always something more to do.

Mine is big enough, and I find it manageable to keep up with. But I do think if I were much bigger, it could become a bit of a headache. So, everybody has to figure out what's right for them.

This has worked well for me, but do remember when you build the layout and start operating, there's going to be ongoing maintenance with that layout.

**MRH:** We have found layout complexity matters more than layout size when it comes to layout maintenance. The single component that most adds complexity to your layout is turnouts. Your layout here is big, but it's not all that complex

because you have a lot of single track between towns without many turnouts.

**If you can become an expert on turnouts, building them (if you're into doing that), installing them, maintaining them, wiring them – then 90% of your layout maintenance is keeping those turnouts running smoothly.**

**If you have a derailment, 90% of them will be at turnouts.**

**Mike:** We had a saying on the real railroad that the best, the cheapest turnout to maintain on the railroad is no turnout at all. Turnouts were one of our highest-cost items to maintain. Turnouts were a pain in the rear – those frogs and those points.

People may not think it's much, but boy, they take a beating, and they wear badly from all the loads rolling over them. So, no turnout is the best turnout [laughs].

**MRH: What scenery techniques do you use?**

**Mike:** I used cardboard strips along with hot glue and staples to build a web. Then I covered that with plaster cloth. Once the plaster cloth set up, I used joint compound over the top of that, and smoothed it out.

Then I used flat black or flat brown latex paint, and applied Woodland Scenics primarily ground foam and ground cover. I would drench it in the diluted white glue. I've had good results with that.

There's a couple of places where I used Woodland Scenics' Mold-A-Scene material, a plaster type material that you mix to an oat-meal consistency. You put it in place to create some rock formations and whatnot. I found that worked pretty well, too.

**MRH: How do you build your trees?**

**Mike:** The trees on my layout are primarily Woodland Scenics trees. I haven't built any of my own trees from scratch, they're all Woodland Scenics trees.







17. Directly below the Inver Grove St. Paul caboose track [16] is the Amourdale Kansas City yard engine-servicing facility. The massive Mo-Kan food services facility looms over the scene in the back.

**MRH: What time of year are you modeling?**

**Mike:** The season that I model is generally summertime, late spring-summer.

As to the era, it's from 1964 to 1974. The sixties were a decent decade for the Rock Island. The seventies not so much, although the early seventies weren't too bad. But by the mid-seventies, the Rock Island was having a rough time.

**MRH: What kind of locomotives do you use?**

**Mike:** I've got every brand and type of locomotive. I have a couple of Atlas yellow-box units that I've dolled-up. I have a lot of other Atlas units, I have Athearn Genesis, and a lot of Life-Like Proto2000 units, plus I've got some Kato units. I've had good luck with most of them.

I did have to do a bit of tuning on some of them because the electrical pickup on certain brands isn't as good as others. I think my

favorite as far as reliability are the Atlas locomotives – I've had especially good luck with those.

## **MRH: What brands of rolling stock do you use?**

**Mike:** My rolling stock is all across the board. I've got a lot of Athearn blue box from many years ago. I still have some of my equipment from the 1960s that I got in my first train sets. And I still operate those today.

I have a lot of Kadee cars I've acquired over the years. I also have many Walthers cars, many Athearn Genesis cars, and a lot of Atlas cars. I'm pleased with most of them.

I do want to mention Accurail shake-the-box type kits. *(This is an old-time hobby joke; the idea is these kits are so simple you can just "shake the box" and they will come together. – ed.)*

I think Accurail kits are some of the best models; everything fits together so well. The coupler height is always correct and they're es-



18. The 11-track Armourdale yard runs almost the full length of a wall on the lower deck.



**REGISTER**  
(free)

[INDEX](#)

[TABLE OF CONTENTS](#)

pecially good-looking. Their lettering is generally quite accurate. So I have developed a fondness for Accurail kits over the years.

**MRH: Tell us about the structures on the layout: scratchbuilt, kitbash, or what?**

**Mike:** The structures are a combination of scratchbuilt structures and models right out of the box – with the latter being mostly Walthers-type models.

A friend of mine, Ollie Millhouse, built seven of my stations. All I did was provide Ollie with the drawings, and he did the rest. He's a master craftsman when it comes to structures, and did a beautiful job on them.

I built a number of Walthers kits and some of their miniature scenes. I'm thinking of the Design Preservation Models (DPM) kits.

**MRH: What about your bridges?**

**Mike:** I've got a number of bridges. I've got a couple of timber bridges that are Walthers kits. I also have some through plate girder bridges from Central Valley that I adapted to fit the space. I've had to do some slight kitbashing with several of the bridges.

**MRH: Do you host regular operating sessions?**

**Mike:** I've had a couple of operating sessions, and I hope to have one before June of this year. Typically, 10 to 13 people will attend an operating session, and it'll last about three hours.

In the past, I have not had a dispatcher. I pretty much use a hybrid train order/track warrant form, and the operators get their train direction from that. But the upcoming operating session, I want to have a dispatcher giving train orders/track warrants to the operators.

During a typical operating session, I'm the trainmaster or roadmaster. I walk around and help people with any questions they have about the layout, such as where a certain track is that they're supposed to switch. So, I walk around, make sure everything's going OK, and that nobody's having any serious problems.

I do run a train during an op session on rare occasions. But typically, with the number of operators we have, I let them operate as much as possible, and I just stand by, observe, and help out with any problems.

**MRH: How much to you like HO? Would you ever consider doing a layout in a different scale or gauge?**



19. Mike has one of the nicest staging arrangements we've seen on any layout. All the staging is double-ended, and staging for both decks sits in the open, in one closet-style room. Mike has convenient storage units with cars and locomotives at his fingertips.



**REGISTER**  
*(free)*

[INDEX](#)

[TABLE OF CONTENTS](#)



**Mike:** I grew up with an HO train set being my first real train set. I will say that prior to the HO, my father had picked up an S scale (I think it was an AC Gilbert) train set. It had a circular piece of track, and it was neat.

But once I got the HO bug, I pretty much stuck to it. As far as going to another scale, I'm an avid HO scale man. I can't see myself changing.



**MRH: What is your philosophy on doing a layout well? For example, how do you narrow the focus?**

**Mike:** My idea of doing a layout well is to make a good plan up-front and good drawings of what exactly you want to build. Realize you need to be flexible because you probably will run into situations where something isn't a real good fit – it's too cluttered, or too crowded, and want to avoid that.

I think the key is to always develop a really good plan, but remain flexible.

**MRH: What advice would you give to someone just starting out in the hobby?**

**Mike:** Take advantage of the great assortment of products that are out there. You

don't have to go big. Just start with a small layout.

I started out with a four-by-eight sheet of plywood and built an oval track with a couple of side tracks for industries. I had as much fun with this layout as with anything later.

But for somebody who wants to do more than that, do it. It doesn't need to be a really large layout. Just build a size you're comfortable with.

Don't be intimidated, and reach out to others in the hobby who can help you with things you may not know how to do. You'll find out pretty quickly you really can do it.

Once you get into some of the woodworking techniques, start laying track, and doing some of the simple wiring, you'll find that you



20. Mike uses his track schematic labels in staging as well. Off to one side, he has kill switches for the power to each of the tracks. He says this helps eliminate problems with idling locomotives making noise or drawing current.



REGISTER  
(free)

[INDEX](#)

[TABLE OF CONTENTS](#)

really enjoy it. Enjoy the adventure! Today's a great time to do the hobby, there's so many great products out there today that weren't available 20 or 30 years ago.

**MRH: You will have this layout on tour during the convention this summer, right?**

**Mike:** My plan is to have the layout available for tour. I think it's on Wednesday of that week. And I'm also looking at having the Layout Design SIG group tour the layout.



**MRH: What do you hope the convention-goers that come see this layout get out of the visit?**

**Mike:** I hope that anybody who looks at the layout during the convention will walk away with an appreciation for what the Rock Island Railroad was all about. I do hope they'll also realize model railroading can be done by anybody who's interested in doing it.

I don't consider myself a great "professional" model railroader. I've learned the hobby from the ground up through eight different layouts.

I hope people are entertained by the visit and that they see something that leaves them walking away saying: "that's a nice model railroad."

**MRH: Mike, we've really enjoyed visiting your layout, and our fellow modelers can take it from us - the convention-goers are in for a real treat this August. ☑**

Get more articles like this

GIVE IT A LIKE



# What's new on TMTV

Some recent shining examples ...



Touring the Texas Western club layout



Mike Mackey's Texas  
& St. Louis

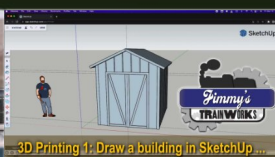

3D printing: Draw a  
building in SketchUp



Ultimate Allagash  
Railway layout tour

## Watch now ...

Buy individual episodes or get unlimited access as a member



[www.trainmasters.tv](http://www.trainmasters.tv)

Registered MRH reader?

**SAVE 10%**  
click here



**REGISTER**  
(free)

[INDEX](#)

[TABLE OF CONTENTS](#)



# DESIGN TIPS FOR CONTROL PANELS



1. Summit Tower panel for the Hudson, Delaware and Ohio (HD&O).

Model Railroad Hobbyist | July 2023



**SCOTT DUNLAP** GIVES INSIGHT  
FOR SUCCESSFUL CONTROL PANEL DESIGN ...

**DESIGNING A LAYOUT INVOLVES MORE THAN JUST LOCATING TRACKS**, structures, and scenic features. The needs of operators are equally important. How easy will it be to move around? Do the controls make sense? Is the layout enjoyable to operate?

Control panels can have a great impact on the overall success of any model railroad. Their locations can determine where people will tend to congregate and how well traffic will move through the layout room. Well-designed control panels improve operators' experiences, while poorly designed panels cause frustration.

Over the years I've have seen well over 800 model railroads and operated on over 150. I have developed a good sense about what works with control panel design, and I'd like to share my thoughts with you.

The control panels used as examples in this article are from the HO scale layout of The Model Railroad Club in Union, NJ. The newest panels are about 30 years old, and many are considerably older. They were installed during the era of conventional DC cab control, and their designs reflect that.

The club operates approximately 50 times a year, and runs trains for the public most Saturdays, during open houses, and on other special occasions. The panels have received quite a workout over time, and look worn. Despite their appearance, they continue to perform well, and most are expected to remain in service for many years to come.

The layout includes three fictional railroads: the Class 1 Hudson, Delaware and Ohio, the interurban and traction Trenton Northern (TN), and the Rahway River short line. Each railroad interchanges with the others, but has its own operating crew, procedures, and control panels.

The layout was converted to DCC several years ago, so future control panels will likely look very different than the ones in place now.

OK, let's get to the design tips.

### INCLUDE CONTROL PANELS IN LAYOUT DESIGN

This first tip is the most important. Too often the design and placement of control panels is not considered until the end of the process. This big mistake could lead to real problems.

### FUNCTIONAL, NOT FANCY

You can add as many bells and whistles as you like, but your panels should work properly, be well-designed, and clearly



labeled. Including important information such as town names and tower designations will help orient your operators. Indicating railroad East and West (or North and South if your prototype runs that way) will be particularly helpful, especially if some or all the panels have East to the left and West to the right.

The Summit Tower panel for the Hudson, Delaware and Ohio (HD&O) [1] may appear confusing at first glance, since there are a lot of lights and buttons, but it is easy to learn. Let's take a closer look.

The row of square white buttons at upper-left operates the phone system that allows the tower man to communicate with the HD&O dispatcher, the towers to the east and west, the Rahway River Railway (there's an interchange here), and the mainline engineers.

The black rotary dials and buttons were used to select cabs before the conversion to DCC. Future panels will not need these.

The blue buttons are used to kill the power to specific sections of track. These are also a throwback to DC operation that will not be used in the future.

The red buttons on the track diagram control the turnouts, and are illuminated to indicate the switch position. The yellow lights indicate occupancy. The green buttons will be used to control signals in the future. The row of red buttons along the bottom are for electromagnetic uncoupling ramps that have yet to be installed.

**Please click on the ads to  
support  
*Model Railroad Hobbyist!***

## MAKE CONTROL PANEL DESIGN CONSISTENT

Once you find a good design, stick with it throughout the layout. There's no need to reinvent the wheel. A consistent design not only will look better, but will make all the panels easier to learn.

These four sample control panels on the TN share a consistent design, are done in the railroad's colors, and include the line's logo [2-5].



2. Bernardsville control panel (TN).

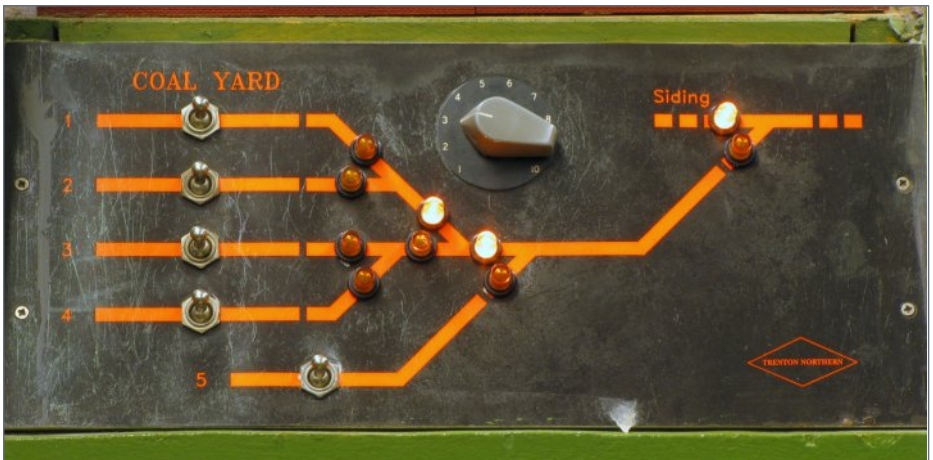

3. This TN panel controls access to the coal yard.







4. The Trenton express control panel.

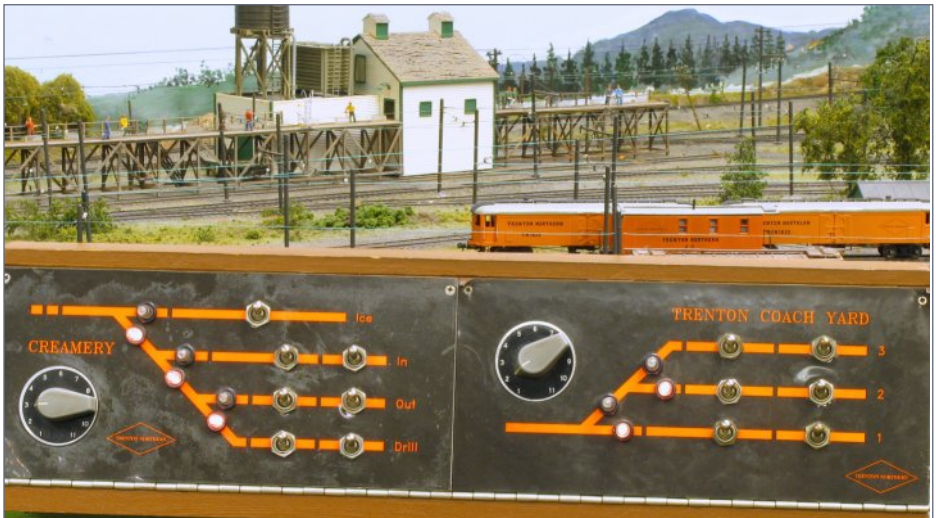

5. The control panels for Trenton Creamery and Trenton Coach Yard.

## MAKE THE CONTROL PANELS ERGONOMIC

The best angle to mount a panel varies depending on its height off the floor, and whether it is designed to be operated while seated or standing. If the panel is to be operated while standing, then operators' eye level may also be a consideration.

Since there is no consistency in operator heights, some compromise is needed. Thankfully, perfection is not required; getting close is good enough. Consider some of these examples [6-8].

Get more articles like this

GIVE IT A LIKE



6. The Trenton Northern's Dispatcher's panel. The wrap-around design makes all the displays easy to see and the controls easily accessible.



REGISTER  
*(free)*

[INDEX](#)

[TABLE OF CONTENTS](#)



7. Back to the HD&O, we see the panel for the Pittsburgh engine facility. It faces up at a near-perfect angle for the operator, who is usually standing.



8. The Gilberton Panel is the largest serving the HD&O, and one of the largest at the club. In addition to Gilberton, site of a major freight yard and passenger station, the panel also handles the town of Ashland (left). At one time it also served a hidden staging yard.



This Gilberton panel [8] is angled 20 degrees back from vertical. At its height, 45 degrees would have been more desirable, but this would have meant sacrificing layout space or encroaching upon a busy aisle. The extra-large track diagram helps to make up for the less-than-perfect viewing angle.

Panels designed to be operated while seated should be high enough that the operator's legs can fit easily underneath. This may seem obvious, but is not always considered [9].

## PLACE CONTROL PANELS IN LINE WITH PORTION OF THE LAYOUT BEING CONTROLLED

Many layouts have controls mounted all along the fascia, essentially making it one large, continuous control panel. This



9. The Ringoes control panel on the TN is usually operated while seated. While it is high enough, its lack of space for the operator's legs makes it uncomfortable to operate.





makes it easy to keep the controls in line with the layout functions they control, and works especially well when the fascia is high enough for easy viewing.

However, the fascia control panel works best with a limited number of tracks and switches. In yards, terminals, and other areas with higher track concentration, conventional panels still work better.

Sometimes, the area controlled is too vast for ready visibility from the control panel. This is the case with Gilberton on the HD&O [8]. The use of repeater control panels can improve the situation with better sight lines and access [10].



10. This repeater control panel for Gilberton provides better sight lines and access than the main control panel can.

## AVOID PLACING CONTROL PANELS IN THE AISLE

When a control panel intrudes into an aisle, it takes away from the aisle space. This is especially important to remember when aisles are narrow.

All the club's panels are built into the layout. Many are disguised into the backs of structures, which makes them almost invisible when viewed from the opposite side [11-14].

## CONSIDER SPATIAL RELATIONS BETWEEN PANELS

When panels are mounted too close together, it leads to overcrowding. Operators using two panels mounted across the aisle from each other can block the aisle.

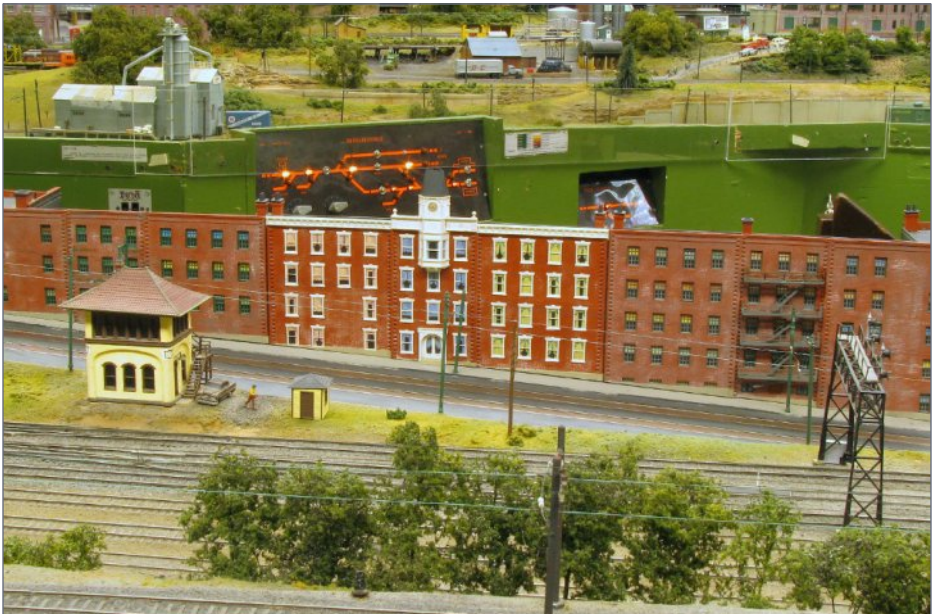

**11. The Summit Tower control panel hides behind this row of buildings.**



12. Bellefonte repeater panel is behind Delco Battery. I was a member of the club for close to two years before I finally realized the Delco Battery building resembles a car battery.



13. A blocked aisle between Gladstone and Gilberton. Fortunately, the aisle is wide enough that the operators (Bob Nalbone at left, me at right) still have the comfort of personal space.





The town of Gladstone on the HD&O is on the opposite side of an aisle from Gilberton. One operator can easily reach both panels when we are shorthanded, but the aisle is completely blocked when each panel has its own operator. A different location for one of them would have prevented this problem [13].

On multilevel layouts, mounting a panel for the upper level directly above a panel for the lower level can create the same problem. Unfortunately, in the case of a multilevel layout, widening the aisles would not help with the operators' personal space.

## BE CREATIVE!

Sometimes, you need a control panel after the layout is already in place. One technique we've used is to find buildings large enough to fit a control panel and make the needed modifications [14, 15].



14. This is an ordinary brick factory next to a quarry in Ashland.



REGISTER  
(free)

[INDEX](#)

[TABLE OF CONTENTS](#)



## CONCLUSION

Even with careful planning and adherence to good design principles, it may not be possible to locate every panel perfectly, mounted at just the right height and angle. Compromise is inevitable. Including the control panels in the early design, as opposed to relegating them to afterthoughts, will help achieve superior results. ☑

Get more articles like this

GIVE IT A LIKE



## SCOTT DUNLAP



Scott was a member of The Model Railroad Club, Inc. of Union, NJ for over thirty years. His other previous clubs include the Baltimore Society of Model Engineers and the Dekalb Model Railroad Club. Scott relocated to Roswell, GA in 2021 and is currently a member of the North Atlanta Rail Barons as well as the NMRA and the LDSIG and OPSIG interest groups.

Scott's favorite railroads include the Baltimore and Ohio, the Pennsylvania, and the Atlantic Coast Line. ■

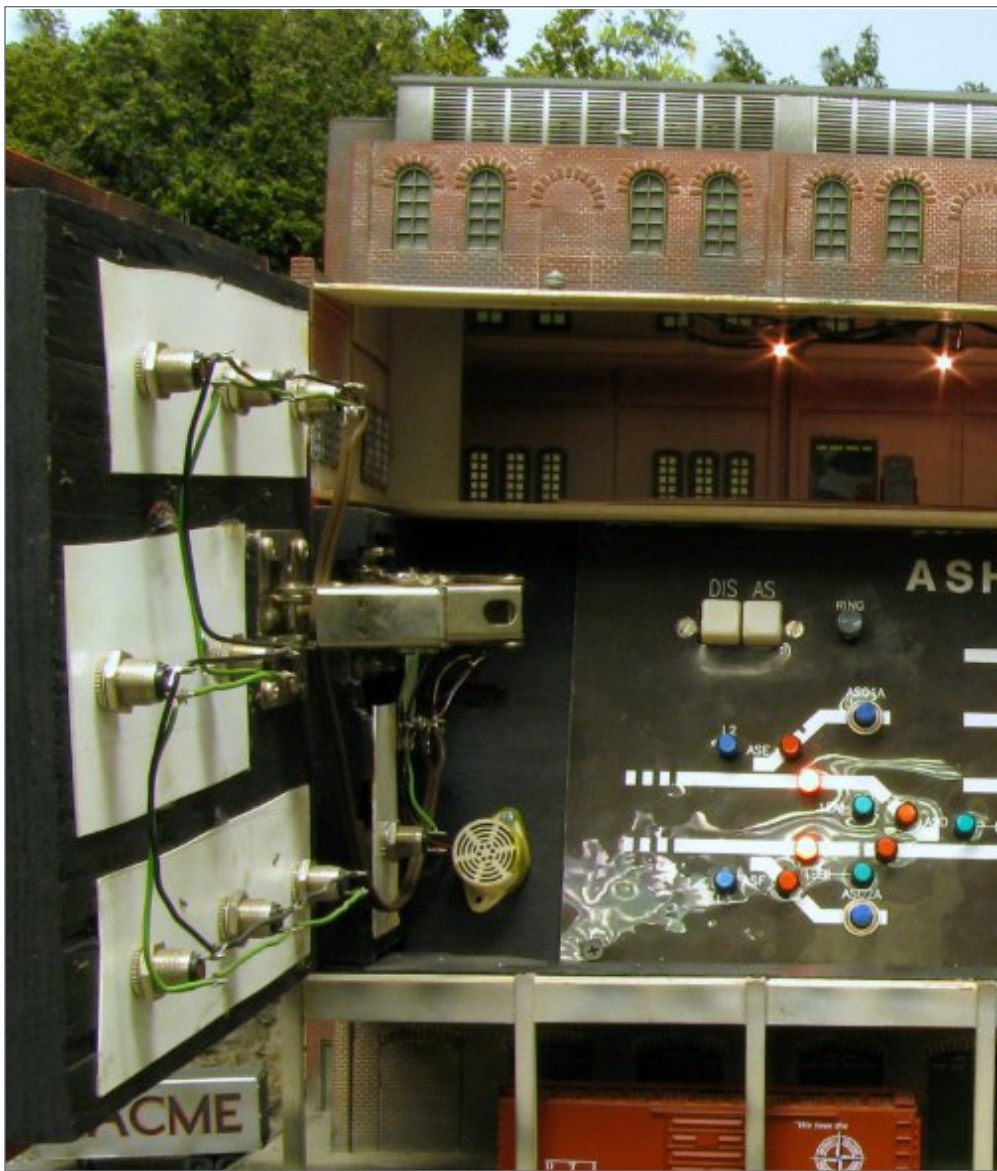

15. Opening the brick factory reveals the control panel that handles the Ashland quarry sidings. Club member Paul Preuss added the control panel long after the building's installation. The design is a favorite among members and guests.



REGISTER  
*(free)*

[INDEX](#)

[TABLE OF CONTENTS](#)

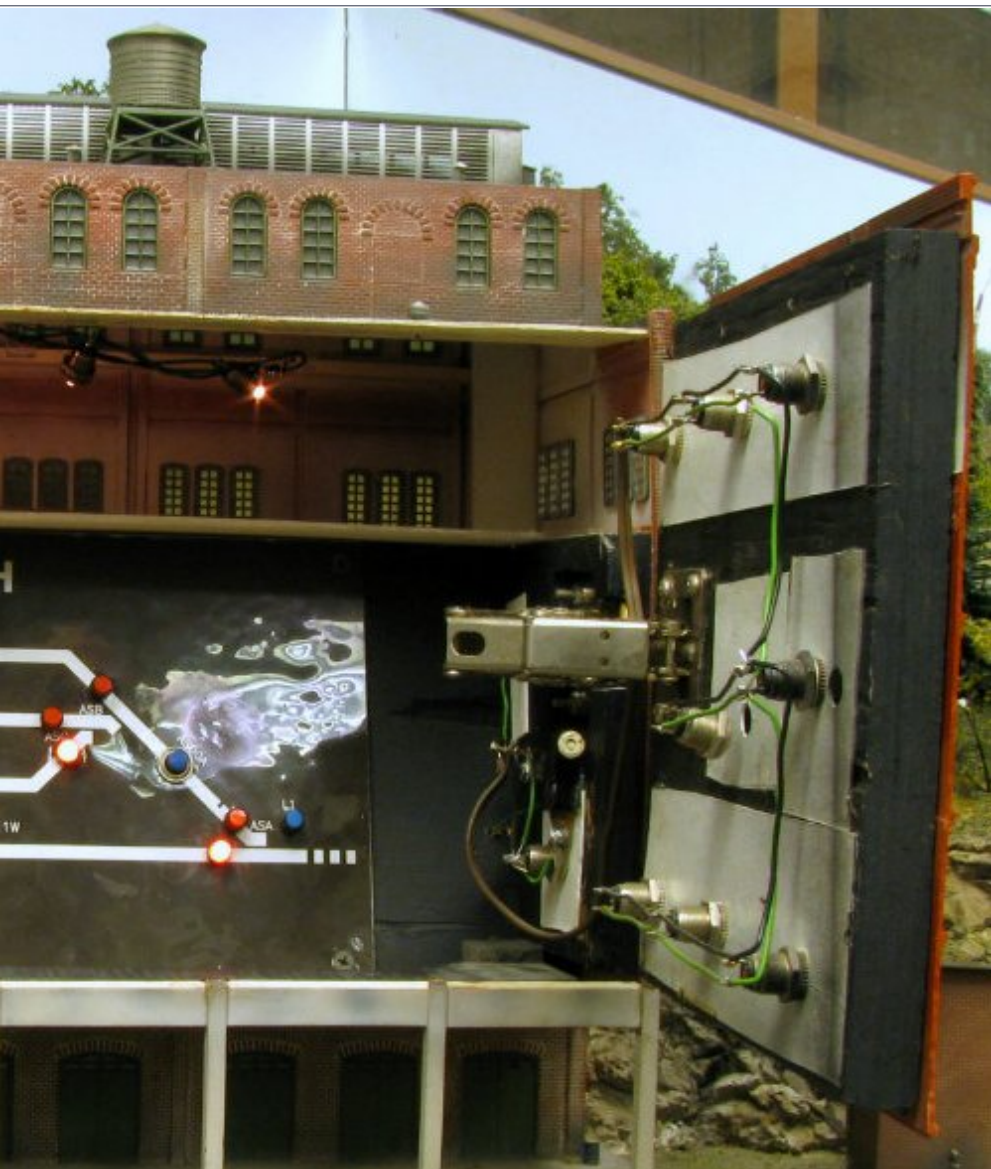

Get more articles like this

**GIVE IT A LIKE**





**MRH helps you  
avoid breaking  
the bank!**

**SPECIAL DEAL:**

*Subscribe now and get  
the next 12 issues plus*

**ALL 52 BACK ISSUES!**

**\$29.99**

**2.99 per 250+ pgs**

**Get MRH  
Running Extra**

[click here](#)



**REGISTER**  
*(free)*

[INDEX](#)

[TABLE OF CONTENTS](#)



# SAVVY MODELER *Online*



Get more articles like this

GIVE IT A **LIKE** 

Model Railroad Hobbyist | July 2023

 **Play this**

Watch on



**WATCH  
THE  
VIDEO**  
click here

## Proto2000 SD7 Loksound V5 Decoder install

In this 1 hour video, YouTuber **Solo Contracting** shows step-by-step how he installs a LokSound V5 decoder into an HO diesel.

While the video runs for an hour, there's a lot of good techniques shown. This is a great illustration of how to use a Decoder Buddy board to simplify a 21-pin sound decoder install. Makes the process pretty much just solder on the wires, plug in the decoder, and you're off.



 **GREAT MODELER VIDEOS ON THE WORLD WIDE WEB**

# 43rd National Narrow Gauge Convention



Tim Bain photo

## *A Mile High & Three-Foot Wide*

**AUGUST 30 - SEPTEMBER 2, 2023**

**IN DENVER, COLORADO**

**LEARN MORE ►**



**REGISTER**  
*(free)*

[INDEX](#)

[TABLE OF CONTENTS](#)

# JULY NEWS

column



Model Railroad Hobbyist | July 2023

**RICHARD BALE AND JEFF SHULTZ**  
REPORT THE LATEST HOBBY  
INDUSTRY NEWS ...



## INDUSTRY NEWS

### **ExactRail is ScaleTrains Latest Acquisition**

ScaleTrains has completed the acquisition of Utah-based ExactRail, a producer of prototypically accurate HO and N scale rolling stock. ExactRail was co-founded in 2009 by financier John Pestana and toolmaker Chris Clune. Chris Brimley, who was appointed president of ExactRail in 2022, has joined ScaleTrains and will oversee the transition of ExactRail products into the ScaleTrains family. This will include marketing ExactRail products through hobby dealers. Previous ScaleTrains acquisitions include the purchase of MTH's line of HO and S scale products in late 2020. In June 2022 ScaleTrains acquired the assets of N scale manufacturer Fox Valley Models from founder Matt Gaudynski. ScaleTrains was established in 2015 by four former Athearn employees including Paul Ellis, Mike Hopkin, Joe Olvera, and Shane Wilson who continues as president of the Tennessee-based company ...

### **Palomarez Joins InterMountain**

Chris Palomarez has joined InterMountain Railway where he will be involved in product development, planning and research.

**THE LATEST MODEL RAILROAD PRODUCTS, NEWS & EVENTS**

Palomarez' extensive experience in the hobby includes research and product development at Microscale and product development and later brand manager at Athearn ...

## N Scale Vehicle Awards

Officials at the National N Scale Convention held in Reno, Nevada in June have announced the winners of the 19th Annual N Scale Vehicle of the Year award.



The winner was Rapido Trains for their GM New Look transit bus. The Enhanced N Scale Vehicle of the Year Award went to Showcase

Miniatures for their Pierce Class pumper truck. MRH extends congratulations to both Rapido and Showcase Miniatures.

---

## NEW PRODUCTS FOR ALL SCALES

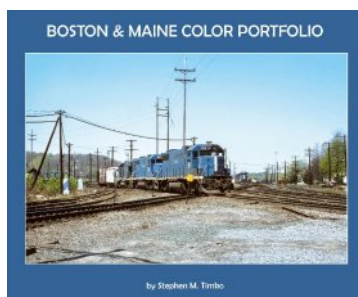
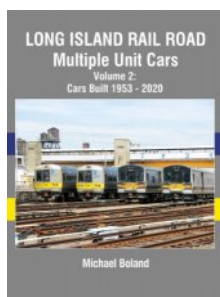

**Morning Sun** has published volume two of *Long Island Railroad Multiple Unit Cars*. Author Michael Boland continues the history of the vast fleet of MU cars

owned by the LIRR including the Pullman-Standard fleets of 1955 and 1963, MTA cars from 1968, the Metropolitans and the M3s, M7s, and M9s of 2020. The hardbound book has 128 mostly color pages.

Also new from Morning Sun is a 96-page *Boston & Maine Color Portfolio*. Stephen Timko has assembled a fascinating selection of photos of the Route of the Minuteman dating from the last of steam to the Guilford era. Switch engines, passenger units, covered wagons, and modern diesel road power are all covered.



REGISTER  
(free)

[INDEX](#)

[TABLE OF CONTENTS](#)



Cabooses, passenger trains, and RDCs each have a chapter.

Info: [www.morningsunbooks.com](http://www.morningsunbooks.com)

---

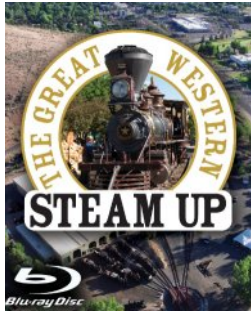

**Railroad Showcase** has produced *The Great Western Steam Up* on Blu-Ray disc or streaming. Celebrating the 150th anniversary of the completion of the Virginia & Truckee RR, the Great Western Steam Up was a gathering of many vintage steam locomotives at the Nevada State Railroad Museum in Carson City, Nevada on July 1-4, 2022. The video documents the events of the Steam Up,

including nine engines in steam, the history of the Virginia & Truckee Railroad, and the development of the Nevada State Railroad Museum. Bonus features of the Blu-Ray include firing of the 1875 wood burning 4-4-0 "Inyo," an interview with Ed Dickens of the Union Pacific steam program, and extended interviews with the participants in the Steam Up.

Info: [www.rrshowcase.com](http://www.rrshowcase.com)

---

## CLUB CARS



The St. Louis **Gateway** 2020/2022 NMRA National Convention has a remaining stock of convention cars

available for purchase. Two HO scale car types are available, the 2020 ExactRail Bethlehem 4-bay coal hopper with load decorated for the Missouri Public Service Company featuring a Ready Kilowatt figure and the 2022 Tangent GATX 1917-design 8,000-gallon Tank Car with a custom convention logo decal sheet and a road number that was not made commercially available.

Both cars are available singly or in 3-packs, with different road numbers available for the ExactRail car and the same number



for all the Tangent cars. To purchase or for questions contact Brad Joseph at [clincs.gateway2022@gmail.com](mailto:clincs.gateway2022@gmail.com) or 618-779-8899.

Info: [www.facebook.com/gatewayrollingstock](https://www.facebook.com/gatewayrollingstock)

---

## 0 SCALE PRODUCT NEWS



**Atlas O** has scheduled a second quarter 2024 release for a new production run of ACF 50' 6" boxcars. The Trainman series model represents one of the more than 5,000 prototypes ACF began building in 1974. Spotting features include non-terminating corrugated ends, 10' Youngstown sliding doors, and a diagonal paneled roof. The car does not have a running board and the brake wheel is at a lowered position.



The model comes with contemporary roller-bearing trucks with rotating bearing caps. Both 2-rail and 3-rail versions of the model will be available.



Road names will be Railbox (large logo), Guilford (Maine Central), Rock Island, GATX-Warwick, BKTY-Union Pacific and Santa Fe.

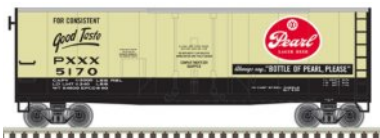

Additional O scale models coming from Atlas O during the second quarter of 2024 include this Trainman series 40' plug door boxcar decorated for beer service.



**REGISTER**  
(free)

[INDEX](#)

[TABLE OF CONTENTS](#)



Beer brands represented in this release will be Falstaff, Lucky Lager, Pearl, Stroh's, Pabst and Old Milwaukee.



Atlas O has recently released several new O scale models including RSD-7/15 diesel locomotives, Amtrak P42 Genesis locomotives and a group of

Amfleet passenger cars.



Road names for the RSD-7/15 are Chesapeake & Ohio, Duluth, Missabe & Iron Range, Pennsylvania, Santa Fe and

Canadian Pacific. Although the majority of the items in this release are sold out at the factory, participating Atlas dealers may have some of these items available.

Info: [shop.atlasrr.com](http://shop.atlasrr.com)

---

## HO SCALE PRODUCT NEWS

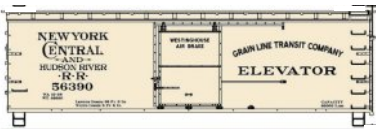

New HO scale car kits coming from **Accurail** include a 3-car set of 36' New York Central & Hudson River double-sheathed wood boxcars.

Each model in the 3-car set has a different number. Single cars are also available.



Scheduled for release later this year is a 40' wood reefer decorated for Nickel Plate Lackawanna Dairy Line. The HO scale model is based

on a prototype reefer built in 1928.



This 50' Soo Line boxcar with exterior posts, 10' plug doors and welded steel sides, displays a build date of 5-70.

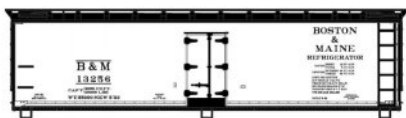

Accurail's kit for this HO scale 40' Boston & Maine wood refrigerator car follows a prototype built in May 1923 with ice bunkers at each end and 4' swing doors. All Accurail HO scale car kits come with Accumate knuckle couplers and appropriate trucks with Delrin wheelsets.

Info: [www.accurail.com](http://www.accurail.com)

---



R. Bale

## EMD SD70ACe

EMD developed the SD70 series of diesel-electric locomotives to counter GE's popular Dash 9-44CW.

More than 5,700 SD70 units have been produced since production began in 1992, with most being SD70M and SD70MAC models. The SD70ACe is the successor to the SD70MAC with several design changes to comply with emission standards. The SD70ACe engine features fewer components in the inverter and functions with 15 percent lower internal pressure to significantly reduce emissions. Tier 2 versions of the SD70ACe are rated at 4,300hp. Subsequent Tier 3 models are rated at 4,500hp.

**Athearn** plans to release upgraded versions of Genesis SD70ACe/SD70M-2 diesel locomotives in November 2024. The HO scale models will be available with road specific details for Union Pacific, Norfolk Southern, Southern Pacific, Progress Rail, New Brunswick Southern, and Susquehanna, Providence & Worcester.



Three Union Pacific road numbers will be available with variations in front

ditch lights, antennas and a modernized inverter cabinet. All will feature the UP shield on the nose.



**REGISTER**  
(free)

[INDEX](#)

[TABLE OF CONTENTS](#)





In 2012, Norfolk Southern unveiled a group of 20 locomotives painted to honor their predecessor roads. Athearn's Norfolk Southern Heritage group will include SD70ACE models decorated for NS/Savannah & Atlanta, NS/Erie, NS/Jersey Central, and NS/Penn Central. The Heritage units will have high-mounted headlights and front and rear ditch lights.



Two Southern Pacific SD70ACE units will be in this release. Road number 814 is an early EMD production unit equipped with high headlights and a non-isolated cab.



Four former Norfolk Southern SD70M-2 locomotives were acquired by the New York, Susquehanna & Western Railway in late 2020. The units were initially placed in service wearing standard NS black paint with a small NYSW patch on the cab. The units were repainted in NYSW's yellow and black scheme in early 2023.



Athearn's November 2024 production schedule includes three New Brunswick Southern SD70M-2 locomotives. The former NS units have been repainted in three slightly different green paint schemes for NBS, Maine Northern, and Eastern Maine. All have front and rear ditch lights and display small Canadian and American flags on the nose. Additional road names in this release include Providence & Worcester Railroad, and Progress Rails, an Alabama-based subsidiary of Caterpillar.



Athearn's November 2024 production schedule includes a Genesis EMD MP15AC switch engine. The HO scale model is based on a group of switch engines

EMD built between 1975 and 1984. The AC suffix indicates an MP15 fitted with an alternator and rectifier instead of the usual DC-generator system. Two Union Pacific road numbers will be available in this release.



Three Southern Pacific road numbers will be available with SP-style cab number boards and slight variations in lights and bell location.



Soo Line acquired a group of Milwaukee Road MP15AC's in the mid-1980s. Spotting features include a small fuel tank. Athearn will offer three Soo Line road numbers.



Three MP15AC units decorated for the GMTX lease company will be included in Athearn's late 2024 release. Two of the GMTX switchers are ex-Soo/ ex-MilwRd locomotives with small fuel tanks and ratchet brake handles. The third GMTX unit, #333, is an ex-SP locomotive with a large fuel tank, a brake wheel and SP-style number boards. An MP15AC decorated for New York & Atlantic will be included in the November 2024 release.

Athearn SD70ACe/ SD70M-2 and MP15AC models mentioned in this report will be available with and without sound. Sound units will come with a factory installed DCC decoder and SoundTraxx Tsunami2 sound.



This 60' high-cube boxcar is included in Athearn's November 2024 production schedule.



The HO scale model is based on a 100-ton prototype built by International Car Co. Road names will be B&O-Chessie System, CSX, Louisville & Nashville, Missouri

Pacific, Rock Island, and Norfolk & Western. A minimum track radius of 22" is recommended for this 60' car.



Fifty-foot steel reefers with ice bunkers are included on Athearn's November 2024 production schedule. Models decorated for Santa Fe, Santa Fe MOW, Western Fruit Express, Wilson, and Fruit Growers Express with have freight-style roller-bearing trucks.

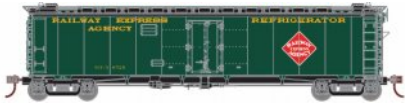

A car decorated for Railway Express Agency will be equipped with Commonwealth high-speed equalized trucks. Additional details include separately applied end tack boards and door latch bars, photo-etched brake platforms, wire grab irons, and positionable Santa Fe-style reversed ice hatches with etched hatch stops.



Athearn has included a 48' container in its November 2024 schedule.



Decorating schemes will be Allied, American President Lines, ATSF/BN, Burlington Northern, Canadian National, and CP Rail. The models will be sold in 3-packs with individual numbers.

Info: [www.athearn.com](http://www.athearn.com)

---

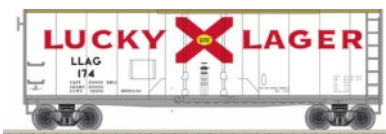

Atlas' production schedule for the second quarter of 2024 includes a group of HO scale 40' plug door boxcars.



Each of the Trainman cars will be decorated for familiar brands of American beer including National

Bohemian, Old Style, Falstaff, Lucky Lager, Pabst, and Old Milwaukee.



separately applied uncoupling levers and trainline hoses, etched metal cross over platforms and 100-ton trucks with 36" machined metal wheels.

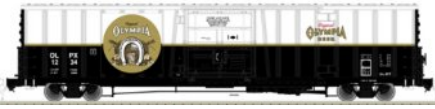

Decorating schemes will include Lone Star, Olympia, Pabst and Schaefer.



Completing Atlas's series of beer schemes is a group of HO scale 50' flatcars with two trailers.



The sets will include Falstaff trailers on an ATSF flatcar, Ballantine/EL, Hoffman/CNJ, Old Milwaukee/MilwRd, Pearl/TXTC, Rainer/GN,

Schaefer/TTX ,and generic BEER/Conrail.

Info: [shop.atlasrr.com](http://shop.atlasrr.com)

---



**Bowser** plans to release a new production run of HO scale Baldwin diesel road switchers this month. The release includes AS-16, A-S616, A-S416 and DRS-4-4-1500 and DRS-6-6-1500 units.



Four-axle AS-16 units will be available decorated for Erie, Erie-Lackawanna, and Baltimore & Ohio.



DRS-4-4-1500 models based on a four-axle 1500hp prototype will be available decorated for Soo Line and Durham & Southern Railroad.



**REGISTER**  
(free)

**INDEX**

**TABLE OF CONTENTS**





A six-axle DRS- 6-6-1500 will be available for Soo Line, Duluth, South Shore & Atlantic and the Union Railroad.



Baldwin pushed the prime mover up to 1600hp in the AS-616 unit and equipped it with a motor on each of the six unevenly spaced axles. Bowser will offer the AS-616 correctly decorated for Milwaukee Road, Chesapeake & Ohio, Baltimore & Ohio, Penn Central, Pittsburgh & West Virginia Railroad, and Duluth, South Shore & Atlantic.



Completing this release will be a Baldwin AS-416 unit with A1A-A1A trucks decorated for Norfolk Southern. Features on all the Bowser models in this release include correct MU hoses, air hoses, windshield wipers, operating headlights, window glass, can motors with flywheels, blackened nickel silver wheels and knuckle couplers. The ready-to-run models will be available with LokSound (sound and DCC) or for analog DC (DCC-ready) with a 21-pin connector for easy installation of an aftermarket decoder.



Bowser is accepting pre orders through August 11, 2023, for a new production run of Pennsylvania Railroad class N-8 cabin cars.

Bowser's HO scale model is based on the 200 prototype N-8 cabin cars built by PRR at its Altoona shop in the early 1950s.

Models displaying a circle Keystone will be available decorated for PRR's New York Region, Eastern Region and Central Region. Central and Western Region cars with a circle Keystone will have a Trainphone antenna on the roof.



Models with a Shadow Keystone will be available for the Philadelphia Region. Lake and Pittsburgh Region cabin cars with a Shadow Keystone will have Trainphone antennas.



An N-8 cabin car with a plain Keystone will have a Trainphone antenna and a yellow cupola.



Models decorated for Conrail and Penn Central will be included in this release.



R. Bale

## HIGHWAY TRAILERS

Common highway trailers are generally categorized as Plate Wall or Sheet and Post trailers. The terms refer to the construction of the trailer walls. Sheet and Post

trailers have wood or metal posts with sheets of wood or metal between them. This type of construction offers more strength and durability, but sacrifices an inch or two on internal width of the trailer. The few extra inches can make a significant difference as shippers are doing everything they can to cut costs. The internal posts can also be problematic for orderly loading of palates. It is also difficult to clean trailers with internal posts which makes them unsuitable for hauling some food products. Plate Wall trailers have smooth wall interiors supported by external posts. This makes them an inch or two wider inside, easier to load and easier to clean. However they are generally less sturdy than Sheet and Post trailers. The choice between Plate Wall or Sheet and Post construction often depends on the type of lading to be hauled. The maximum external width of trailers in the United States is 102 inches.



New models under development at Bowser include a 53' Plate Wall

highway trailer. The HO scale Executive Line model will be available unlettered with bodies painted black, blue, green, red, white and yellow. Pre orders are being accepted through August



**REGISTER**  
*(free)*

[INDEX](#)

[TABLE OF CONTENTS](#)

11, 2023 with delivery planned for fall 2024.

Info: [bowser-trains.com](http://bowser-trains.com)

---

Get more articles like this

GIVE IT A LIKE



R. Bale

## BERKSHIRE 2-8-4 STEAM LOCOMOTIVES

Beginning in the early 1920s shippers began to demand faster freight service which at that time was dominated by 2-8-2 Mikados that were known for their reliable power -- but not for their speed. Speed would come from larger drive wheels and a larger fire box that could provide greater steam heating capacity. A four-wheel trailing truck would be required to support a bigger fire box. The result was a 2-8-4 wheel arrangement. Lima Locomotive Works built the first 2-8-4s in 1925 for the Boston & Albany which used them successfully through the Berkshire Mountains – which gave the wheel arrangement its name. Subsequent users included Nickel Plate, Pittsburgh & Lake Erie, Chesapeake & Ohio, and Pere Marquette railroads. All were generally similar in appearance.



An exception was twenty-five 2-8-4 class T-1 Berkshire's Lima delivered to the Boston & Maine Railroad in the mid-1920s. They had a circular Coffin feedwater heater tank mounted on the front of the smoke box. In 1945

B&M sold 17 of its distinctive Berkshires to the Santa Fe and Southern Pacific railroads.



Broadway Limited has announced plans to deliver two HO scale versions of Boston & Maine Class T-1a 2-8-4 Berkshire steam locomotives this fall. Four road numbers will be available with 4-wheel tender trucks, and two numbers with 6-wheel tender trucks. Both versions will also be available painted but unlettered.



HO scale versions of Union Pacific 4-8-8-4 Big Boys are also coming from Broadway Limited later this year. This release will include three numbered Class-1 Big Boys, two numbered Class-2 Big Boys, and an unpainted model of each. BLI will include two models of #4014 as it appears today with slight paint variations based on the timeframe.



Additional versions include two models of the Big Boy in UP's two-tone gray paint scheme – one with aluminum lettering and one with yellow lettering. This is a fantasy paint scheme as the real Big Boy never received this scheme.

Both the B&M Berkshires and the UP Big Boys will be equipped with Paragon4 Sound/DC/DCC with smoke and GoPack capacitors. The models will also be available in BLI's DC no-sound Stealth Series. Stealth models are DCC-ready for installation of an aftermarket DCC decoder.

Info: [www.broadway-limited.com](http://www.broadway-limited.com)



Centralia Car Shops has released an HO scale UP-type cupola caboose in a variety of liveries including five yellow Union Pacific schemes.



**REGISTER**  
(free)

[INDEX](#)

[TABLE OF CONTENTS](#)





Additional road names include Great Western, two green MOW cars, and a UP in box car red.



Centralia has also released Southern Pacific class C-40-4 bay-window cabooses in six SP schemes.



Centralia cabooses feature an injection molded plastic body, wire and etched metal parts, metal wheel sets and metal knuckle couplers.

Info: [www.intermountain-railway.com](http://www.intermountain-railway.com)

---



**ClassOneModelWorks.com** has announced a second run of HO scale Monon 48' exterior post

containers in a Norfolk Southern Triple Crown paint scheme. Available in two-packs, there are six new road numbers available. Info: [classonemodelworks.com](http://classonemodelworks.com)

---



**InterMountain Railway** has released two new HO scale GE Evolution series Tier 4 ET44 diesel locomotives to its dealers.

Road names include Navajo Mine Railroad in two numbers. Both units are former GE demonstrators with the same road numbers. Road specific details include an early square exhaust stack and an antenna dome on the cab roof.



ET44 diesel units decorated for Kansas City Southern are available in eight road numbers. KCS details include a Type 2 PTC antenna

array, triple intake grilles behind the cab and a modified exhaust stack with angled sides for increased clearance. The HO scale models are available with an ESU non-sound decoder

(a DC plug option is available on request) and with factory-installed ESU sound decoders.



InterMountain has also released an HO scale model of a Gunderson FMC exterior post wood chip gondola. The HO scale model is available decorated for Apache Railway, Willamette & Pacific, Southern Pacific, two Montana Rail Link schemes and three different Burlington Northern schemes.



Additional HO scale models recently released by InterMountain are a series of Bathtub coal gondolas. Six numbers each are available for CP Rail–Ontario Hydro, DREX ex-CP, DREX, ex-Procor, MLMX-Sims Metal, and MWCX-ex CP.



InterMountain is booking reservations through August 31, 2023 for a new production run of an HO scale GE U18B light road switcher. The model is based on 1800hp light road switcher built by General Electric in the early 1970s.



Road names will be Maine Central (Eagle scheme), Maine Central (two Guilford schemes), Seaboard Coast Line, Pickens (with Blomberg trucks recycled from a trade-in), CSX (ex-SCL), and CSX (MOW scheme). The models will come with a factory installed ESU sound decoder or ESU non-sound decoder. A DC plug will be available on request.

InterMountain is booking reservations through July 31, 2023



for an HO scale 1958 cu. ft. twin-bay covered hopper car. Features include an etched metal roof walk, wire grab irons, wire brake rigging, 33" machined metal wheels and Kadee couplers.



**REGISTER**  
*(free)*

[INDEX](#)

[TABLE OF CONTENTS](#)

Cars with open end cages will be available in six numbers decorated for Illinois Central, Union Pacific, Frisco, Chicago & North Western, Conrail, Chesapeake & Ohio, and GACX-Boraxo. This production run will include a Burlington Northern car with closed sides. Availability is TBA.

Info: [www.intermountain-railway.com](http://www.intermountain-railway.com)

---



**Jacksonville Terminal Company** has announced new 53' 8-55-8 corrugated steel containers in HO scale for pre-order. The 8-55-8 containers have Inter-Box Connecting (IBC) pins in scale ISO 40' locations for compatibility with other containers, prototype matching fronts and door styles, and separately applied door rods.



The containers are available in 3-packs, with one release of a Milestone container scheme available as a single. Other road names include Matson, UMAX, Estes, C.H. Robinson, and Florida East Coast.

Info: [jtcmmodeltrains.com](http://jtcmmodeltrains.com)

---



The latest release from **Kadee** is a 40' PS-1 boxcar decorated for the New York New Haven & Hartford Railroad. The HO scale model is stenciled for a car repainted in 11-52 and shopped in 5-54.

Kadee's model is an accurate reproduction of a prototype built by Pullman-Standard in 1947. Like the prototype, Kadee's HO scale version features 7' seven-panel Superior sliding doors and Bettendorf-type plain-bearing trucks.



Details include a see-through Apex running board and brake step, individual grab irons, ladders, and stirrup steps. The ready-to-run model comes with Kadee Magna-Matic metal delayed-action couplers.

Info: [www.kadee.com](http://www.kadee.com)

---

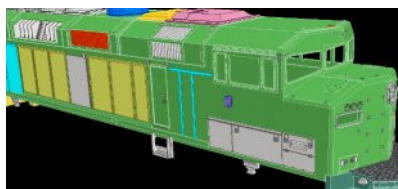

**Maple Leaf Trains** is preparing a 3D printed body shell for an HO scale GO Transit F59PH.

Availability is TBA. In addition to the main body shell, the kit will include formed wire grab irons,

handrails, lift rings and several clear optional detail parts including headlights, classification lights, ditch lights, and platform lights, The shell is designed for application on an Atlas GP38/GP40 chassis which requires some minor modification.

Info: [www.mapleleaftrains.com](http://www.mapleleaftrains.com)

---



**Moloco** is accepting non-funded reservations for another run of its HO scale 50' RBL boxcar as built

by Pacific Car & Foundry beginning in 1959. Moloco models in this run will have double plug doors filling a 16' opening. Road names include CSS-Chicago South Shore & South Bend Railroad. The model is based on a prototype built in 11-64.

Two numbers will be available.



This release includes Southern Pacific and SSW-Cotton Belt cars that were both built 10-64 with Evans DF-B bulkheads. An

undecorated car will also be available.



Moloco is also taking reservations for a re-run of an HO scale 50' PCF RBL boxcar with a single 10' offset plug door. Two new numbers will

be available for the NIRX-Chicago & Illinois Midland car. Items in this report are expected to be available in 2024.

Info: [www.molocotrains.com](http://www.molocotrains.com)

---

**Rapido** is booking advance reservations for a second release of its well-regarded HO scale North American Bilevel Commuter



REGISTER  
(free)

[INDEX](#)

[TABLE OF CONTENTS](#)





Cars. Road names on this new release include ACE-Altamont Commuter Express, CalTrain, Coaster, FrontRunner, GO Transit, Rail Runner and Sounder. Undecorated models will also be available.



Variations depending on the road name and series being modeled include smooth or riveted sides, four or five windows on the lower level, different size tinted windows and single or dual cab front windows. The cars will be equipped with inside-bearing trucks with roller-bearing axles and metal wheelsets.



The underbody and car interior feature Rapido's usual attention to detail. Full lighting features will be available.



Rapido is preparing final tooling for an HO scale Canadian National 5304 cu. ft. boxcar. The HO scale model accurately replicates a prototype with a combination sliding and plug door developed by NSC in the 1970s.



Created from both field research and original prototype blueprints, Rapido's HO scale version features separate door posts and door latches, correctly formed

uncoupling levers, etched details, factory installed grab irons, a fully-detailed underframe, and 100-ton Barber S-2 trucks with metal wheels.

Paint schemes will include CN (as-delivered with green door), CN (late 1980s repaint), CN (1986 Expo scheme), CN



(North American) and unlettered painted BCR.



Also under final development at Rapido is a model of a NSC 3294 cu. ft. Canadian Pacific mechanical reefer. The HO scale model faithfully represents the prototype NSC built for CP beginning in 1966.



Rapido's HO scale version will have separate door posts and door latches, uncoupling levers, individual grab irons, wire stirrup steps, a fully-detailed underframe, Rapido semi-scale metal knuckle couplers and 100-ton Barber S-2 trucks with metal wheels. The trucks will have electrical pickup for modelers wishing to add a reefer sound unit which will be available as a separate purchase.



Some of the real cars were repainted into the classic CP Rail Multimark scheme, but the majority retained their as-delivered red script schemes. Paint schemes available on Rapido's HO scale model will be CPR script, CPR late script, CP Rail Multimark and painted but unlettered. The order deadline is mid-September, 2023.



Rapido plans to make a new release of its HO scale GMD-1 light road switcher with new road numbers and two new paint schemes. When delivered in the late 1950s the 1900 series GMD-1s were used in commuter and other short-run passenger services. They were later used in light freight service with some remaining active until the late 1990s.



**REGISTER**  
(free)

[INDEX](#)

[TABLE OF CONTENTS](#)



Canadian National created the 1400-series rebuilds in 1989. Most of the upgrades were internal with the principal spotting feature being ditch lights and a larger 2,000

gallon fuel tank. CN retired the last of the 1400s in 2021.



Liveries planned for this second release include CN 1400 (stripe scheme), CN 1900 (noodle scheme with black cab), CN 1900 (noodle scheme with red cab), CN

1900 (green scheme). Two additional schemes – Waterloo Central and Oregon Pacific RR – are conditional releases pending receipt of sufficient advance reservations.



All GMD-1s in this release will be available for DC/no sound and with DCC ESU V5 sound decoders. Delivery is planned for 2024 with a pre-order deadline of October 16, 2023.

Info: [www.rapidotrains.com](http://www.rapidotrains.com)



ScaleTrains is booking reservations through July 31, 2023 for a Thrall 86' high-cube boxcar with double plug doors. The HO scale model is based on a prototype Thrall introduced in 1964. Availability of the model is planned for January 2024.



Both Operator and Rivet Counter models will be available decorated with five

unique road numbers each for Wabash, Frisco, Denver & Rio Grande Western, Chicago & North Western, Southern and Santa Fe.



The Rivet Counter model represents an as-built version of the prototype with a running board, full

height ladders and an etched stainless steel Apex crossover platform. The brake wheel and housing are positioned high on the end. The Rivet Counter models will come with 70-ton ASF trucks with 33" machined metal wheels.



Operator series models represent modified prototypes that have had running boards removed,

ladders shortened and the original trucks upgraded with Barber S-2 100-ton trucks with 36" wheels. Operator models have simplified lettering and lack grab irons and other add-on details. A detail kit (SXT 81985) with grab irons, uncoupling levers and trainline hoses is available as a separate purchase.



ScaleTrains' second run of HO scale GP30 locomotives will include ATSF, B&O, CB&Q, Conrail, Cotton Belt, Southern,

and Southern 2601 as it is at the North Carolina Transportation Museum.



The models feature LED front, rear, and side walkway lights, road number and era specific details such as light packages, and

Southern high short hoods that are set up to run long hood forward. Preorders are due by Monday July 31, 2023, with delivery this winter.



The first new ExactRail Platinum car from ScaleTrains is the HO scale Pacific Car & Foundry 7633



[REGISTER](#)  
(free)

[INDEX](#)

[TABLE OF CONTENTS](#)



appliance boxcar. Created in 1975, the 60' high cube boxcars were rated at 70-tons. Roadnames in the first run include original owners Milwaukee Road, Missouri Pacific, Texas & Pacific, and Western Pacific. Former Milwaukee Road cars repainted for CP Rail and Western Pacific and Missouri Pacific cars patched or repainted to Union Pacific have also been announced. The car will also be available as an undecorated kit.



The car will be equipped with Kadee #156 couplers in a narrow-style draft box that includes shank wedges, striker casting, and nut

and bolt details. The model features wire coupler cut levers, separately applied air hoses, and drop-down brake rigging, and the Barber 70-ton S-2 trucks are equipped with CNC-machined metal wheelsets.



R. Bale

## USRA TWIN-BAY HOPPER

At the beginning of World War I, serviceable freight cars were in short supply. To solve the problem, the federal government nationalized the railroads under the United States Railway Administration (USRA).

Among the initial responsibilities of the USRA was to establish six basic freight cars designs. The final designs included a 30' twin-bay open hopper car rated at 50-tons. It had a capacity of 1,880 cubic feet. The car had eight flat panel sides supported by exterior posts. In 1918 orders for a total of 25,000 steel hoppers were spread between six car builders. Most were delivered with Andrews 2D-F3 trucks. The USRA all-steel twin bay hopper car proved to be a fundamentally sound design. After the war, the American Railroad Association (ARA) adopted the USRA design and upgraded its capacity to 55-tons. Thousands of copies were built with many remaining in service through WWII.



Fox Valley brand name. It will be produced from tooling acquired from M.T.H. The ready-to-run model is composed of over 100 individual parts. The original M.T.H. model received very good reviews for prototypical accuracy when it was introduced in 2011.



The USRA model will come with correct Andrews-type trucks with 33" machined metal wheels and plastic Type E knuckle couplers. Individually applied details will include wire grab irons, and cast stirrup steps, end ladders, handbrake and underbody brake system.



Road names will be Northern Pacific, Pennsylvania Railroad, Colorado & Southern (Burlington Route), CC&O-Clinchfield, Canadian National and Baltimore & Ohio.



53' corrugated dry containers with an expected release date of December 2023.



Decorating schemes will include FedEx, Hub Group (with roof logo), Schneider, Schneider 30th Anniversary, J.B. Hunt Intermodal, J.B. Hunt/CIMC, Twin Logistics, XPO Logistics and YRC. The models will be available in singles and in 3-packs.

Info: [www.scaletrains.com](http://www.scaletrains.com)

Get more articles like this

GIVE IT A LIKE



REGISTER  
(free)

[INDEX](#)

[TABLE OF CONTENTS](#)



New items coming from **Walthers** this fall include this 50' bulkhead flatcar. The HO scale Proto series model is based on a prototype built by the Canadian Car & Foundry. Three road numbers each will be available for Algoma Central, BCOL-British Columbia Railways, BCIT-British Columbia Railways, Indiana Harbor Belt, DWC-Duluth, Winnipeg & Pacific, and Montana Rail Link. Two Canadian National schemes will also be available.

The model features a die-cast frame with separately applied ladders and factory installed grab irons. The ready-to-run model comes with appropriate trucks with 33" machined metal wheelsets.



Walthers is quoting a September 2023 release date for an 81' eight-axle depressed center flatcar. The heavy die-cast model rides on four 100-ton trucks with 36" machined metal wheels.



The Mainline series model will be available decorated for Burlington Northern, TTX, WECX-Westinghouse Electric, Chicago & North Western, KRL-Kasgro Rail, Norfolk Southern.

Info: [www.walthers.com](http://www.walthers.com)



Info: [www.walthers.com](http://www.walthers.com)



---

## N SCALE PRODUCT NEWS



**Athearn** is developing an N scale version of a 50' steel refrigerator car with ice bunkers. The models are scheduled for release in November 2024.

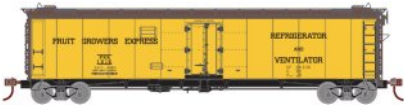

Models will be available decorated for Santa Fe, Santa Fe MOW, Western Fruit Express, Wilson, Fruit Growers Express and Railway Express Agency. Details include screw-mounted trucks, Santa Fe-style reversed ice hatches, separate brake rigging and McHenry operating spring couplers.



Athearn has included a 48' container in its November 2024 schedule.



Decorating schemes for the N scale containers will be Allied, American President Lines, ATSF/BN, Burlington Northern, Canadian National, and CP Rail.



The models will be sold in 3-packs with individual numbers. Info: [www.athearn.com](http://www.athearn.com)



**Atlas'** N scale production schedule for the second quarter of 2024 includes a group of 40' plug door boxcars.



Each of the Trainman models will be decorated for familiar brands of American beer including Falstaff, Lucky Lager, Pearl, Pabst and Old Milwaukee.

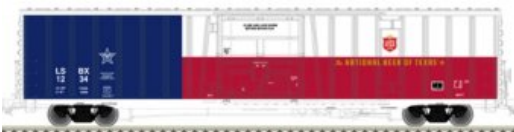

Also scheduled for release during the second quarter of 2024 is an N scale BX-177 boxcar. The Master

series model will have separately applied uncoupling levers and trainline hoses, etched metal cross over platforms and 100-ton trucks with 36" machined metal wheels.



**REGISTER**  
(free)

[INDEX](#)

[TABLE OF CONTENTS](#)





Decorating schemes will include Lone Star, Olympia, Pabst and Schaefer.

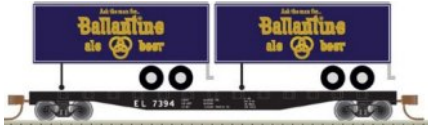

Completing Atlas' series of beer decorating schemes is a group of N scale 50' flatcars with two trailers.



The sets will include Falstaff trailers on a ATSF flatcar, Ballantine/EL, Hoffman/CNJ, Old Milwaukee/MilwRd, Pearl/TXTC,

Rainer/GN, Schaefer/TTX, and BEER/Conrail.

Info: [shop.atlasrr.com](http://shop.atlasrr.com)

---



DCC ready Baldwin 2-8-0 Consolidation locomotives are now available in N scale from **Bachmann Trains**. The

ready-to-run DC powered locomotive features a DCC socket, operating headlight, a hidden drivetrain, E-Z Mate Mark II couplers, and separately applied details such as the bell, whistle, pop valves, handrails, builders plate, and sanding lines. Roadnames available are Erie, Frisco, and Pennsylvania.



Also available are DCC Econami Sound Value equipped 2-8-0 Consolidations, with factory

sound that includes multiple whistles, bells, chuff sounds, air pumps, and dynamos with cylinder cocks. Other standard Econami sounds are also included in 16-bit polyphonic sound. Road names available with Econami Sound Value decoders are New York Central, Western Pacific, Union Pacific, and Southern.

Info: [shop.bachmanntrains.com](http://shop.bachmanntrains.com)

---



**Broadway Limited** has introduced a series of 40' N scale stock cars that are available with or without sound.

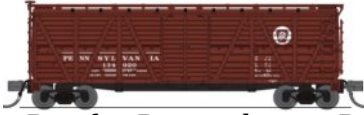

Cars decorated for Santa Fe, Chicago, Burlington & Quincy; Chicago North Western, Canadian Pacific, Northern

Pacific, Pennsylvania Railroad and Union Pacific are available with sounds of cattle, mules or sheep.



The same road names are also available without sound. Cars decorated in five fantasy schemes

with patriotic and holiday sounds are also available.

Info: [www.broadway-limited.com](http://www.broadway-limited.com)

---



R. Bale

## EMD SD40-2 DIESEL LOCOMOTIVE

The SD40-2 was one of EMD's most popular locomotives. During its 17 year production run that began in 1972, EMD produced nearly 4,000 of the 3,000hp SD40-2s. Although higher-horsepower locomotives were available, the reliability and versatility of the SD40-2 made it one of the best-selling models in EMD's history. The SD40-2s principal improvement over the SD40 was its modular electronic control systems. A variety of low front noses ranging from 81" to 123" in length housed additional electronic gear along with a more commodious toilet for crew members.



**InterMountain** is working on an N scale SD40-2 diesel locomotive for delivery in 2024.

The 3,000hp SD40 series was an exceptionally popular locomotive for EMD. The Dash 2 variation, introduced in early



REGISTER  
(free)

[INDEX](#)

[TABLE OF CONTENTS](#)

1972, featured HT-C high-traction trucks and a new modular electronic control system.



InterMountain's N scale version of the SD40-2 will feature flashing ditch lights. Road names include Santa Fe,

Canadian Pacific, Milwaukee Road, CSX, Union Pacific, FURX (ex-BN patch), G&W Marquette Rail and Iowa, Chicago & Eastern. Advance reservations are being accepted through July 31, 2023.



An ACF twin-bay covered hopper car is expected from InterMountain in 2024. Advance reservations for the N scale model will close August 31, 2023.



Decorating schemes include Norfolk & Western, Chicago & North Western, Burlington Northern, BNSF (new image), Great Northern, CEFX, HLMX

(ex-MKT) and Union Pacific.

Info: [www.intermountain-railway.com](http://www.intermountain-railway.com)



New N scale models recently released by **Micro-Trains Line** include this PS-2 twin-bay covered hopper decorated for Southern Pacific. The model represents one of 450 all-welded prototypes

delivered to SP in 1957. Like the prototypes, the model rides on Bettendorf-type plain-bearing trucks.



The prototype of this insulated plug door boxcar with Bettendorf-type trucks was built in 1967. Micro Trains N scale version of the 50'

prototype is decorated for Illinois Central.



This Micro Trains N scale model is based on a 50' boxcar built by Pullman-Standard in 1962 with

offset double-doors.

Info: Contact a Micro Trains dealer.

---



R. Bale

## GE AC4400CW DIESEL LOCOMOTIVE

The AC4400CW, sometimes referred as AC44CW, is a 4,400hp diesel electric locomotive built by GE Transportation Systems between 1993 and 2004. A total of 2,834 were produced. Similar in appearance to the Dash 9-4CW, the AC4400CW is equipped with AC traction motors instead of DC, with a separate inverter for each motor. Early AC4400CW units were delivered with Hi-Adhesion trucks. Later the AC4400CW became the first GE locomotive to offer an optional self-steering truck, which was designed to improve adhesion while reducing wear on the railhead. Some railroads including CSX, ordered the AC4400CW locomotives with 20,000 lb. extra weight to increase tractive effort. As a result of more stringent emission requirements that became effective in January 2005, GE replaced the AC4400CW with the ES44AC.



diesel electric locomotive.



The Rivet Counter models will be equipped with LED headlights, ditch lights and number boards. Individual factory-applied details include wire grab irons, trainline hoses, MU cables, uncoupling levers, windshield wipers, mirrors, sunshades and brake wheels.

**ScaleTrains** is planning an early 2024 release date for a new N scale GE AC4400AC

Get more articles like this

GIVE IT A **LIKE**



REGISTER  
(free)

[INDEX](#)

[TABLE OF CONTENTS](#)





Road names on the initial release will be BNSF (Gullwing cab, Heritage II scheme), Canadian Pacific (Beaver), Canadian Pacific (Beaver with carousel logo), CSX (YN2), CSX (YN3) and Ferrosur.



Additional road names will be Southern Pacific (Bloody nose), Southern Pacific (Bloody nose with Sunset logo), Union Pacific (Yellow sill stripe), Union Pacific (Red sill stripe, high cab-mounted number boards), and Union Pacific (ex-SP with yellow sill stripe).



DCC sound equipped locomotives will have an ESU LokSound 5 Micro decoder. An early 2024 release date is planned.



ScaleTrains has announced plans to release a new N scale Pullman-Standard 4427 cu. ft. covered hopper car this fall. The model is currently in production and will be the first former ExactRail model released by ScaleTrains.



The 1960s-era freight car will be available in six road names including TDLX-Cargill, TLDX-Peavey, Far-Mar-Co, Rock Island, Northern Pacific and Milwaukee Road. The models will have factory installed Micro-Trains #1015 couplers and equalized 100-ton ASF Ride-Control trucks with machined metal wheelsets.



Additional details include individually applied air hoses, bell crank, brake appliances and photo-etched stainless steel roof walk and brake platform.



ScaleTrains is preparing another production run of N scale CIMC 53'

corrugated dry containers with an expected release date of December 2023.

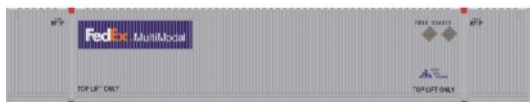

Decorating schemes will include FedEx, Hub Group (with roof logo),

Schneider, Schneider 30th Anniversary, J.B. Hunt Intermodal, J.B. Hunt/CIMC, Twin Logistics, XPO Logistics and YRC. The models will be available in singles and in 3-packs.

Info: [www.scaletrains.com](http://www.scaletrains.com)

---

## NEW STRUCTURES & SCENIC SUPPLIES



**Atlas** has announced details on new vehicles scheduled for release during the second quarter of 2024. Both N and HO scale editions of Ford Fairmont

station wagons will be available. Automotive colors include Jade Metallic, Medium Chestnut, black, Light Chamois, Medium Blue, Silver Metallic and Dark Cordovan Metallic.



An HO scale Ford F-350 Crew Cab pickup truck will be available in white, black, Safety Yellow, Safety

Orange, and a red fire truck scheme. Police pickups in black and in white will also be available. Some of the F-350 pickups will have utility beds.

Info: [shop.atlasrr.com](http://shop.atlasrr.com)

---

**Berkshire Valley Models** has released a kit for an O scale horse-drawn RFD mail wagon. The kit is composed of white-metal castings and laser-cut wood. Assembly and painting are required.



REGISTER  
*(free)*

[INDEX](#)

[TABLE OF CONTENTS](#)



A horse and a driver are available as a separate purchase.

Info: [www.berkshirevalleymodels.com](http://www.berkshirevalleymodels.com)



**Frenchman River Model Works** has introduced a 1:48 scale kit for a sidewalk basement entrance. The kit depicts stairs descending into a stone lined entrance with a door. The nicely detailed item can be used for a variety

of applications from a speakeasy, dance club, apartments, and tattoo parlor – even a model railroad club meeting in a basement of a downtown brick building. The basement door has a window making it suitable for an interior scene with lighting.

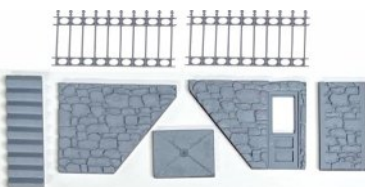

The kit includes resin walls, stairs and floor, two resin wrought iron fence sections, window glazing and instructions. Signs are included for live music, tattoo parlor, antiques, fallout shelter and model railroad club meeting.

Info: [www.frenchmanriver.com](http://www.frenchmanriver.com)



New 1:87 scale vehicle models from **Oxford Diecast** include this 1957-58 Cadillac

Eldorado sedan in sandalwood beige with a silver roof.

Also new from Oxford is a 1956 Ford Thunderbird decorated in Fiesta Red over Raven Black. Details include a Continental-style spare on the trunk and fat white wall tires.

Info: [www.walthers.com](http://www.walthers.com)



**Minifer**, a France-based producer of structure kits, has released an HO scale kit for a European-style Art deco two-story residence. The name of the kit is Le Pavillon de Neuilly. The kit is composed of laser-cut cardboard and wood. Illustrated instructions are available to download.

The assembled model has a footprint of 3.74" x 3.54".

Info: [www.minifer.fr](http://www.minifer.fr)

---



**miniprints** has released a 3D printed model in HO, S, and O scales of the classic Sheffield

Handcar, including a figure positioned to operate it. Inspired by the handcar owned by the Colorado Model Railroad Museum in Greeley, Colorado, the car pump handle moves up and down and the wheels rotate on the model. Used by railway service personnel, the light weight of the handcar allowed it to be placed on and taken off the rails at any location. The model pictured is the HO scale version and is approximately 1-1/8 inches long.

Info: [miniprints.com](http://miniprints.com)

---



**Showcase Miniatures** has released two new HO scale kits for a Chevrolet Kodiak/

GMC Topkick truck including a bare chassis and a propane tank truck. The kits come with two grilles allowing modelers to assemble either the Chevy or GMC version of the truck. The kit consists of a 3D printed cab, vacuum formed windshield



and etched stainless and pewter metal details.

Info: [www.showcaseminiatures.net](http://www.showcaseminiatures.net)

---



New scenic items coming from **Walthers** includes a kit for an HO scale two-story house under construction. The all-new laser-cut kit uses real wood with prototypical dimension and natural wood color. The assembled model has a footprint of

approximately 3.40" x 4.40". Availability is scheduled for winter 2024.

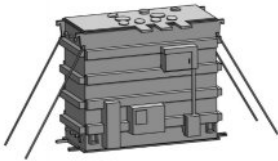

Also new is a kit for a large industrial transformer. The item is suitable as an HO scale flatcar load or as an industry detail. The kit consists of injection molded gray plastic parts. Assembly and painting are required.



The newest addition to Walthers extensive line of HO scale track items is a 36" section of Code 83 FlexTrack with narrow wood ties. The reduced dimensioned ties make the track suitable for branch lines and in yards. A 6" length of Code 83 to Code 70 transition track is also available from Walthers.

Info: [www.walthers.com](http://www.walthers.com)

---

## NEW DECALS, SIGNS AND FINISHING PRODUCTS

Dan Kohlberg of **ICGdecals** has released five new sets of water slide decals for Illinois Central and Illinois Central Gulf covered hopper cars. The decals are specifically designed for use on Tangent's HO scale GATC 4700 cars that replicate a prototype that received several different paint schemes during its service life. Decal sets are available for the as-delivered scheme, as repainted in orange in 1972, the ICG repaint period from 1972 to 1977, the 1977-1978 small ICG logo period, and the simplified 1978-83 repaint.

Info: [www.icgdecals.com](http://www.icgdecals.com)

---



## BRIEFLY NOTED AT PRESS TIME ...

**ScaleTrains** has purchased a partnership stake in Virtual Railfan, which has over 100 livestreaming cameras along rail lines throughout the United States and into Canada. During a recent interview with Ray Arnott on the Around the Layout podcast, ScaleTrains president Shane Wilson indicated that this partnership would allow them to expand 'outside of the model railroading box.'

Info: [scaletrains.com](http://scaletrains.com)

**Jacksonville Terminal Company** has announced several paint schemes for their 40', 48' and 53' N scale containers. Schemes include two special Labor Day schemes, schemes for NRail, JTC 5th Anniversary, and Modern Santa Fe in the Visionary line, and nine different roadnames in their standard line.

Info: [jtcmodeltrains.com](http://jtcmodeltrains.com) ■

---



### DISCLAIMER .....

The opinions expressed in this column are those of the writer and do not necessarily reflect the opinion of Model Railroad Hobbyist or its sponsors. Every effort is made to provide our readers with accurate and responsible news and information, however, neither Model Railroad Hobbyist or the writer of this column can be held responsible for any inaccuracies or typographical errors that may inadvertently appear in this column.



**REGISTER**  
*(free)*

[INDEX](#)

[TABLE OF CONTENTS](#)

# SELECTED EVENTS



Model Railroad Hobbyist | July 2023

JULY

***Please check with any organization hosting an in-person event for the latest status of the event.***

## Ongoing 2023

**ONLINE, Zoom**, dates vary, see website. Operation Special Interest Group Meetups – limited attendance available.

Info: [www.opsig.org/Virtual](http://www.opsig.org/Virtual)

Archive: [www.opsig.org/Virtual/Past](http://www.opsig.org/Virtual/Past)

**ONLINE, Zoom & YouTube**, Wednesday & Saturday, see Facebook page. “New Tracks” Meetup, hosted by Jim Kellow, MMR.

Info: [newtracksmodeling.com](http://newtracksmodeling.com)

YouTube: [www.youtube.com/channel/UCMA\\_VhPb5pjdkAYTdXLceJA](http://www.youtube.com/channel/UCMA_VhPb5pjdkAYTdXLceJA)

**ONLINE, Facebook & YouTube**, dates vary, see Facebook page. “NMRAX” organized by Gordy Robinson, Martyn Jenkins, Gert Muller, Jordan Kramer.

Info: [www.facebook.com/groups/nmragroup](http://www.facebook.com/groups/nmragroup)

**ONLINE, YouTube**, every other Saturday. 4th Division, Pacific Northwest Region, NMRA hosts online layout tours and clinics.

Archive: [www.youtube.com/c/4DPNRMovies](http://www.youtube.com/c/4DPNRMovies)

**ONLINE, Zoom**, Second Tuesdays, 8pm Eastern. “Off the Beaten Track” featuring Narrow Gauge layouts, clinics, and manufacturers.

Info: [groups.io/g/NNG](https://groups.io/g/NNG)

**AROUND THE USA, IN-PERSON**, Various dates. ScaleTrains.com Road Trip.

Info: [www.scaletrains.com/roadtrip](https://www.scaletrains.com/roadtrip)

## July-August 2023

**ARIZONA, PRESCOTT**, July 29, 2023. Beat the Heat Model Train Swap Meet, sponsored by the Central Arizona Model Railroad Club. Embry-Riddle Aeronautical University, 3700 Willow Creek Road.

Info: [camrrc.com/bth](https://camrrc.com/bth)

**CALIFORNIA, CROCKETT**, August 26-27, September 10, October 14-15, December 9-10, 2023. Carquinez Model Railroad Society Open House. 645 Loring Avenue.

Info: [cmrstrainclub.org](https://cmrstrainclub.org)

**COLORADO, DENVER**, August 30-September 2, 2023. 2023 National Narrow-Gauge Convention. Crowne Plaza Denver Airport Convention Center, 15500 E 40th Ave.

Info: [www.43nngcdenver.com](https://www.43nngcdenver.com)

**ILLINOIS, COLLINSVILLE**, July 28-29, 2023. St. Louis Railroad Prototype Modelers Meet. Gateway Convention Center, 1 Gateway Center Drive.

Info: [www.stlrpm.com](https://www.stlrpm.com)

**KANSAS, OVERLAND PARK**, July 27-29, 2023. 2023 Mid-Continent Region Convention. Holiday Inn, US69 & 87th St.

Info: [www.mcor-nmra.org](https://www.mcor-nmra.org)

**INDIANA, FRANKLIN**, August 5-6, 2023. Franklin Train Show, sponsored by the Central Indiana Division/NMRA. Johnson County Fairgrounds, 250 Fairground St.

Info: [www.cidnmra.org](https://www.cidnmra.org)



**REGISTER**  
*(free)*

[INDEX](#)

[TABLE OF CONTENTS](#)



**MASSACHUSETTS, ORLEANS**, July-August 2023, Wednesday Evenings. Nauset Model Railroad Club Annual Summer Open House. Rear of Hilltop Plaza, 180 Rte 6A.

Info: [nausetmodelrrclub.com](http://nausetmodelrrclub.com)

**OHIO, MARION**, August 12, 2023. Summerail 2023 + Railroad Show and Sale. Palace Theater, 276 W Center St.

Info: [www.summerail.com](http://www.summerail.com)

**OHIO, VAN WERT**, July 29-30, 2023. 20th Annual Van Wert Railroad Heritage Weekend. Van Wert County Fairgrounds, 1055 S Washington St.

Info: [www.vwrrhw.com](http://www.vwrrhw.com)

**PENNSYLVANIA, MOUNT UNION**, July 14-16, 2023. Central Pennsylvania Shortline RPM. Bricktown Museum, 300 West Small St.

Info: [meet.pennsyrr.com](http://meet.pennsyrr.com)

**TEXAS, GRAPEVINE (Dallas Area)**, August 20-26, 2023.

NMRA National Convention, Gaylord Texan Resort & Convention Center, 1501 Gaylord Trail.

Info: [www.2023texasexpress.com](http://www.2023texasexpress.com)

**TEXAS, GRAPEVINE (Dallas Area)**, August 25-27, 2023.

National Train Show, Gaylord Texan Resort & Convention Center, 1501 Gaylord Trail.

Info: [www.nationaltrainshow.org/2023/ntsdfw.html](http://www.nationaltrainshow.org/2023/ntsdfw.html)

**WYOMING, EVANSTON**, August 4-6, 2023. 25th Annual Evanston Roundhouse Festival, sponsored by the Hostlers Model Railroad Club and Roundhouse Restoration, Inc. 1440 Main Street.

Info: [hostlers.info](http://hostlers.info)

## Future 2023 by location

**CALIFORNIA, CROCKETT**, June 24-25, August 26-27, September 10, October 14-15, December 9-10, 2023. Carquinez Model Railroad Society Open House. 645 Loring Avenue.

Info: [cmrstrainclub.org](http://cmrstrainclub.org)

**CONNECTICUT, VERNON**, October 29, 2023. Vernon Train Show, sponsored by the Amherst Railway Society. Vernon Center Middle School, 777 Hartford Pike.

**GEORGIA, ATLANTA**, September 7-10, November 9-12, 2023. Anton's Antique Toy & Train Show. Atlanta Expo Centers, 3650 & 3850 Jonesboro Rd SE

Info: [www.scottantiquemarkets.com](http://www.scottantiquemarkets.com)

**GEORGIA, CARTERSVILLE**, September 14-17, 2023. Cartersville Express, 2023 South East Region Convention. Clarence Brown Conference Center, 5450 Ga-20.

Info: [2023serconvention.org](http://2023serconvention.org)

**ILLINOIS, NAPERVILLE**, October 27-28, 2023. Naperville RPM. Northern Illinois University Conference Center, 1120 E Diehl Rd.

Info: [www.rpmconference.com](http://www.rpmconference.com)

**INDIANA, DANVILLE**, November 18, 2023. 16th annual Danville Indiana Train Show. Hendricks County Fairgrounds, Old US 36 (E Main St), 12 miles west of I-465

Info: [www.cidnmra.org/services](http://www.cidnmra.org/services)

**INDIANA, FT. WAYNE**, October 19-22, Fort Wayne Rails, 2023 North Central Region Convention. Holiday Inn Purdue Fort Wayne, 4111 Paul Shaffer Dr.

Info: [div3.ncrnmra.org/fort-wayne-rails-2023](http://div3.ncrnmra.org/fort-wayne-rails-2023)

**MARYLAND, HUNT VALLEY**, September 13-16, 2023. Mid-Atlantic RPM, Delta Hotels Baltimore Hunt Valley, 245 Shawan Road.

Info: [www.marpm.org](http://www.marpm.org)

**MASSACHUSETTS, TAUNTON**, September 17, 2023. 20th Annual Old Colony Model Railroad Club Model Railroad Show and Sale. Taunton Holiday Inn, Myles Standish Blvd, Myles Standish Industrial Park. Exit 9 from Route 495.

Info: [oldcolonyrailroadclub.com](http://oldcolonyrailroadclub.com)

**MASSACHUSETTS, WEST SPRINGFIELD**, January 27-28, 2024. Amherst Railway Society Railway Hobby Show. The Eastern States Exposition Fairgrounds, 1305 Memorial Avenue.

Info: [www.railroadhobbyshow.com](http://www.railroadhobbyshow.com)



**MISSOURI, KIRKWOOD**, October 14-15, 2023. 32nd Annual Greater St. Louis Metro Area Train Show. Meramec Community College Gym, Geyer Road & Big Bend.

Info: [mvns.railfan.net/ShowFlier.htm](https://mvns.railfan.net/ShowFlier.htm)

**MISSOURI, SEDALIA**, November 4, 2023. 12th Annual Sedalia Rails Train Show in Liberty Park.

Info: [www.facebook.com/funtrains](https://www.facebook.com/funtrains)

**NEW MEXICO, ALBUQUERQUE**, November 9-12, 2023. Rails along the Rio Grande, Rocky Mountain Region Convention.

Info: [rnr-nmra.org](https://rnr-nmra.org)

**OHIO, CAMBRIDGE**, October 22, 2023. Fifth Annual NMRA Buckeye Division Train Show. Pritchard Laughlin Center, 7033 Glenn Hwy.

Info: [div6-mcr-nmra.org/trainshow.html](https://div6-mcr-nmra.org/trainshow.html)

**OHIO, WEST CHESTER (Cincinnati)**, October 14-15, 2023. 55th Annual Div 7 NMRA Fall Train Show. Lakota West High School, 8940 Union Centre Blvd.

Info: [www.cincy-div7.org](https://www.cincy-div7.org)

**OHIO, MARION**, October 12-14, 2023. Central Ohio RPM. Marion Union Station, 532 West Center Street.

Info: [www.facebook.com/groups/438383252883060](https://www.facebook.com/groups/438383252883060)

**OREGON, PORTLAND**, October 7, 2023. Bridgetown Railroad Prototype Modelers Meet, Airport Shilo Inn, 11707 NE Airport Way.

Info: [www.brpmm.com](https://www.brpmm.com)

**PENNSYLVANIA, ALTOONA**, October 19-22, 2023, Round the Curve to Altoona, 2023 Mid-Eastern Region Convention. Altoona Grand Hotel, 1 Sheraton Drive.

Info: [mer2023.org/index.html](https://mer2023.org/index.html)

**PENNSYLVANIA, HAMBURG**, September 15-17, 2023. Anthracite Railroad Modelers Meet XI. Reading Railroad Heritage Museum, 500 S. Third St.

Info: [readingrrmm.com](https://readingrrmm.com)

**UTAH, WEST LAYTON**, November 3-5, 2023. The Inter-Mountain Train Expo. Davis Convention Center, 1651 North 700.

Info: [intermountaintrainexpo.com](http://intermountaintrainexpo.com) ■

Get more articles like this

GIVE IT A LIKE



in the **JANUARY 2023 MRH RUNNING EXTRA!**

## Did you see this article?



### Building self-aligning modules

Get full eBook now ▶

← click here



Each eBook has 80-100 pages

## **RUNNING** EXTRA



**REGISTER**  
(free)

[INDEX](#)

[TABLE OF CONTENTS](#)



# WEATHER

*like a pro.*

(No airbrush  
required!)

Go from this ...



To this ...



**Volume 1:  
Freight cars**

**Volume 2:  
Diesel locomotives**

Click me to  
**LEARN MORE ...**

“Simple, effective, and a lot quicker than  
an airbrush ...” - *Koos F.*

DVD or Digital download - From the MRH Store: [store.mrhmag.com](http://store.mrhmag.com)

# THE M420!

**HO  
SCALE**



**ORDER DEADLINE:  
JULY 17<sup>TH</sup>, 2023**

# CLICK HERE



Quality. Style. Spirit.™

[rapidotrains.com](http://rapidotrains.com) • [youtube.com/RapidoTrains](https://www.youtube.com/RapidoTrains) • [facebook.com/RapidoTrains](https://www.facebook.com/RapidoTrains)

**RAPIDO**



**REGISTER**  
*(free)*

[INDEX](#)

[TABLE OF CONTENTS](#)

# CLICKABLE ADVERTISER INDEX

[Accu-Lites](#)  
[Atlas Model Railroad Co.](#)  
[Bachmann](#)  
[BackdropsOnly.com](#)  
[Berrett Hill Trains](#)  
[Black Cat Publishing](#)  
[Blair Line](#)  
[Coffman Graphics](#)  
[Crew Call with Mike Rose](#)  
[Crow River Products](#)  
[Designs by Schonfelder](#)  
[Digitrax \(2 page spread\)](#)  
[East Coast Circuits](#)  
[ESU LokSound](#)  
[Fast Tracks](#)  
[Great Decals](#)  
[Inter-Action Hobbies](#)  
[Iowa Scale Engineering](#)  
[ITLA Scale Models](#)  
[Litchfield Station](#)  
[Logic Rail Technologies](#)  
[Micro-Trains Line](#)  
[miniprints](#)  
[Model Railroad Control System](#)  
[Monashee Laser Engineering](#)  
[Monroe Models](#)  
[Motleys Asset Disposition Group](#)  
[MRH Store \(1\)](#)  
[MRH Store \(2\)](#)  
[MRH Store \(3\)](#)  
[Mt. Albert Scale Lumber](#)  
[National Narrow Gauge Convention](#)  
[NMRA National Convention](#)  
[NCE \(2 page spread\)](#)  
[North American Railcars \(PWRS\)](#)  
[The N-Scale Division](#)  
[Pre-Size Model Specialities](#)  
[Precision Design Co.](#)  
[Proto87.com](#)

[Rapido \(1\)](#)  
[Rapido \(2\)](#)  
[Ring Engineering](#)  
[Rock Island Hobby](#)  
[Roomettes](#)  
[Scale Trains](#)  
[Sceniking.com](#)  
[Scott Antique Markets](#)  
[SiskiyounLine.com](#)  
[SoundTraxx](#)  
[Southern Digital](#)  
[Squeaky's Trains](#)  
[Streamlined Backshop](#)  
[TAM Valley Depot](#)  
[24 Trains TV](#)  
[TrainMasters TV](#)  
[Walthers](#)  
[Westerfield](#)

**Did you see this article?**

in the **JUNE 2023 MRH RUNNING EXTRA!**



**Finding a better  
hot cutter for foam**

**Get full eBook now ▶**

*click here*

**MRH**

**RUNNING  
EXTRA**

Each eBook has 80-100 pages

---

Clickable "other" index

[Other – Contents](#)

[Other – Cover](#)

[Other – MRH Marketplace](#)

[Other – MRH Sponsors](#)

# Coming next month in MRH ...

Jerry Hoverson's Rocky Mountain Central & Colorado Pacific ...



Doing all manner of signs on buildings ...

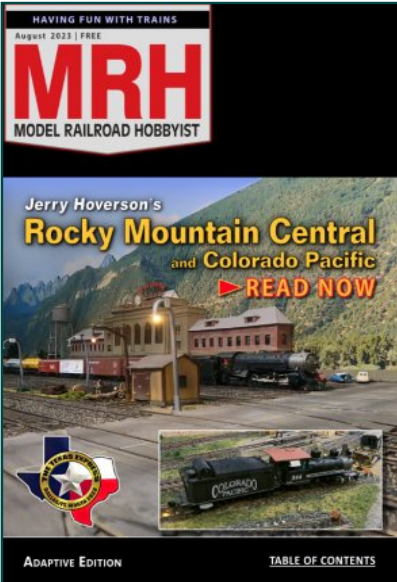

Building a self-actuated coupler ...



... coming August 15<sup>th</sup> in the August MRH



**REGISTER**  
(free)

[INDEX](#)

[TABLE OF CONTENTS](#)



# Coming next month in Running Extra ...

... all the MRH articles and ads, PLUS:

Jeff Johnston does a small steamer sound install ...



Timothy Dudley is on the move again with a new layout module ...



August 2023 - \$2.99

**MRH** **RUNNING**  
EXTRA  
Apprentice with savvy modelers

Jeff Johnston does a ...  
**Small steamer sound install**



**Also these articles:**

- Lorem ipsum dolor sit amet
- Consectetur adipiscing elit morbi
- Vestibulum tempus vehicula
- Mauris tempor libero ipsum pellentesque
- Nullam porta ut arcu at lobortis

... and much more!

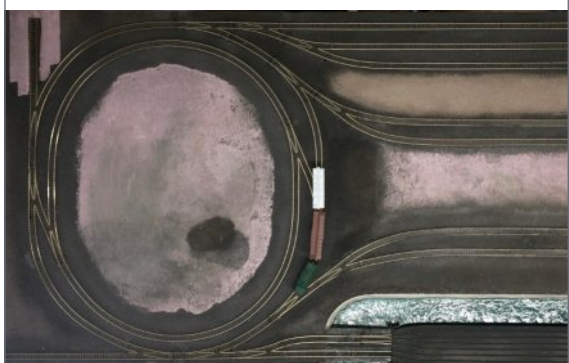

Let's model the NY Bronx Terminal ...

... all this and much more!

**SUBSCRIBE AND SAVE UP TO 80%**