

HAVING FUN WITH TRAINS

DECEMBER 2020 | FREE

MRH

MODEL RAILROAD HOBBYIST

ALSO:

- Realistic ops for the rest of us
- Install a TCS track speedometer
- Custom circuit boards for modelers
- LED strip lighting for your layout
- ... and more inside!

Make your own stone ballast

Any scale, any color [▶ READ NOW](#)



ADAPTIVE EDITION
Landscape or Portrait depending on screen size



DOWNLOAD

[TABLE OF CONTENTS](#)

This is the screen-adaptive PDF version of MRH magazine

This PDF will try to fill the screen. If the screen is wide enough, it displays two facing pages (emulating the old landscape format), otherwise it displays one page in portrait.

On mobile devices, if you change your device orientation, the PDF adapts to fill the screen with either a portrait or a landscape view as appropriate.

WORKS BEST WITH ...

- Windows: open with Acrobat or Firefox
- Mac: open with Preview, Acrobat, or Firefox
- Linux: open with Acrobat or Firefox
- Apple iPad or iPhone: open with SideBooks app (free)
- Android tablet or phone - open with SideBooks app (free)

If you're not seeing the PDF adapt, then your PDF viewer lacks the adaptive display feature. Please use one of the recommended free PDF viewing apps listed above to get the screen adaptive behavior. Or try the Wide Edition instead.

AVAILABLE FOR PRE-ORDER IN DECEMBER 2020 FROM



BALTIMORE & OHIO*

ATLAS MASTER® N & HO SCALE S-4 LOCOMOTIVES



SOUTHERN PACIFIC



PENNSYLVANIA

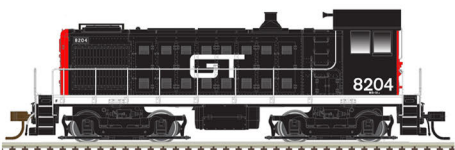

GRAND TRUNK WESTERN



CP RAIL



BOSTON & MAINE



SANTA FE

CLICK HERE!

**GUARANTEE YOUR
PRE-ORDER TODAY!**

*CSX LICENSED PRODUCT

PRODUCTS BEARING THE SOUTHERN PACIFIC MARKS ARE REPRODUCED UNDER TRADEMARK LICENSE FROM THE UNION PACIFIC RAILROAD COMPANY.

FOR MORE INFORMATION OR TO LOCATE A DEALER, PLEASE VISIT WWW.ATLASRR.COM.
ATLAS MODEL RAILROAD CO., INC. • 378 Florence Ave., Hillside, NJ 07205



REGISTER
(free)

[INDEX](#)

[TABLE OF CONTENTS](#)

STAFF

HAVING FUN WITH TRAINS

MRH
MODEL RAILROAD HOBBYIST

Model Railroad Hobbyist |

December 2020 | #130

Editorial Staff



Joe D. Fugate, Publisher and Editor



Patty Fugate, Pasteup and Layout



Richard Bale, News and events



Jeff Shultz, News and events, Tech Assistant



Mike Dodd, Copy Editing



RATE THIS ISSUE

ISSN 2152-7423

Advertising

Les Halmos, Account Manager

Jean-François Delisle, Marketing Assistant

Regular contributors

Eric Hansmann, Editor-at-Large

James Regier, Editing Assistant

Jim Six, Limited Modeler column

Ken Patterson, Reporter-at-Large

Rotating Columnists

Jack Burgess, Getting Real column

Marty McQuirk, Getting Real column

Nick Muff, Getting Real column

Mike Rose, Getting Real column

Tony Thompson, Getting Real column

Rob Clark, Imagineering

Dave Meek, Imagineering

Ray Dunakin, Imagineering

Issue password: Dec2020

Published for the glory of God. [What's this?](#)

MRH SPONSORS



Model Railroad Hobbyist | December 2020

A - L



acculites.com



railroadhobbyshow.com



archertransfers.com

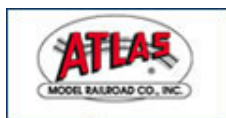

www.atlasrr.com



bachmanntrains.com

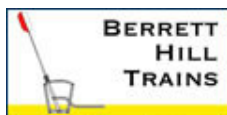

berretthill.com/trains



blairline.com



coffmaneng.com



deluxematerials.co.uk



www.digitrax.com



trackplanning.com



esu.eu/en



handiaidtrack.com



iascaled.com



litchfieldstation.com

[Vendors: Get your clickable logo on these pages ...](#)



REGISTER
(free)

[INDEX](#)

[TABLE OF CONTENTS](#)

MRH SPONSORS | 2

M - Z



micro-trains.com



store.mrhmag.com



ModelTrainTechnology.com



www.modelrectifier.com



handiaidtrack.com/mt-albert-scale-lumber



ncedcc.com



nra2021.com



www.pwrs.ca/main.php



rapidotrains.com



ringengineering.com



roometteslighting.com



scaletrains.com



soundtraxx.com



sodigi.com



sbs4dcc.com



tamvalleydepot.com



trainfest.com



walters.com



woodlandscenics.com

Looking for something? Check the MRH Marketplace!

The advertisement grid for MRH Marketplace | 2 features several categories of products and services:

- CG Models**: HAND MADE HO & N LOADS, CG MODEL TRAINS.COM
- CG Model Trains**: Make your model railroad track come alive, NEW HOBBY TRAINS, www.mrhmag.com
- CG Model Trains**: miniprints, Custom quality custom figures, www.miniprints.com
- CG Model Trains**: INTERACTION, www.interactionmodels.com
- CG Model Trains**: Portables Train Station, www.portabletrainstation.com
- CG Model Trains**: Great Decals™, F&W, L&N Titles, After Hours, Christmas, Leaflet, Coupler Gages and More in O, G, HO, and N Scales, www.mrhmodels.us
- CG Model Trains**: Precision Design Co., CUSTOM DECALS FROM YOUR OWN ART IN JUST ONE DAY, PDC.CA, FULL COLOR & SOLID WHITE
- CG Model Trains**: WESTERFIELD, NEW KIT: AT&SF F&W-EL-1, www.westerfieldmodels.com
- CG Model Trains**: Monogram, L&N, www.monogram.com
- CG Model Trains**: Precision Design Co., CUSTOM DECALS FROM YOUR OWN ART IN JUST ONE DAY, PDC.CA, FULL COLOR & SOLID WHITE

Take me there!



Publisher's Musings: Exhibition layouts

JOE FUGATE



ALL SCALES

MRH Website this month: O scale narrow gauge fun, ...

Compiled by JOE FUGATE



ALL SCALES

What's Neat: Install a TCS speedometer, ...

KEN PATTERSON



ALL SCALES

Custom circuit boards for modelers

EARL HACKET, JR.



ALL SCALES

Make your own stone ballast, any scale, any color

JOE FUGATE



ALL SCALES

Ops for the rest of us: easy, realistic, fun!

DOUG MATHESON

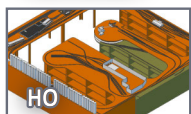

HO

BNSF Witchita 24x24 layout design

DEREK DUNCAN



HO

First Look: East Coast Circuits fully lit police car

JEFF SHULTZ



ALL SCALES

Savvy Modeler online: Easily straighten music wire

Compiled by the MRH STAFF



December 2020 news and events

RICHARD BALE and JEFF SHULTZ



REGISTER
(free)

INDEX

TABLE OF CONTENTS

TABLE OF CONTENTS | RUNNING EXTRA

December 2020

Publisher's Welcome: Neat & tidy DCC installs

JOE FUGATE

Limited Modeler: Building with Layout Design Elements

JIM SIX

The story of modeling six switchers

MIKE ROSE

Prepping cars for layout operation

JAMES EAGER

Pine Ridge Railroad #42 restoration

TOM HOKEL

The Ultimatum Sander

JEFF PALMER

Building a VIA Rail passenger combine

MARC SIMPSON

Ah-Hah Moment: Safe shelf liners for rolling stock

JOE FUGATE

In



RUNNING EXTRA

This month ...

Buy December eBook - \$2.99

106 pages

store.mrhmag.com

ARRIVING
MARCH 2021

THE DEFINITIVE ES44 GEVO

(Actual Rivet Counter Model Shown)



Preorder Now



This product is made under trademark license from General Electric (GE).
© 2020 ScaleTrains.com, Inc. / ScaleTrains.com - Rivet Counter, and
respective logos are trademarks of ScaleTrains.com, Inc.
ScaleTrains.com, Inc. 7598 Highway 411 Benton, TN 37307
844-9TRAINS 844-987-2467 International 423-299-3689



HO
1:87 SCALE

Scene and photography
by Ken J Johnson
Preproduction model shown

 REGISTER
(free)

[INDEX](#)

[TABLE OF CONTENTS](#)

PUBLISHER'S MUSINGS



Model Railroad Hobbyist | December 2020

JOE FUGATE DISCUSSES LAYOUT LIGHTING WITH LED STRIPS ...



WHEN I STARTED DISMANTLING

MY OLD SISKIYOU LINE 1 (SL1) layout a couple years ago, I felt quite excited at my newfound freedom on my next layout, Siskiyou Line 2 (SL2).

Layout construction options now exist here circa 2020 that didn't exist when I started SL1 in 1991 and I could now explore the latest and greatest tech. One of these new tech innovations that's come about is LED strip lighting.

Shopping for LED strips

The first question with LED strip lights: how much light do I need to get a well lit layout space?

LED strip vendors measure light output in lumens, so some conversion to incandescent lights can be helpful. For example, if a 5 meter (16.4ft) LED strip listing says it's 300 lumens per meter, what does that really mean?

Looking at table [1], I can see 300 lumens per meter equals roughly 30 watts of incandescent light per meter. In other words, that sounds rather dim – but is it really?

Let me throw in another consideration as well – the distance of the light from the layout surface. If you remember your high school science class, light drops off with the square of the

1. Table of lumens to much more familiar incandescent light bulb watt equivalents.

Comparing light to energy					
Lumens	220+	400+	700+	900+	1300+
Incandescent	25w	40w	60w	75w	100w

distance. Actually there's another term for this intensity of light on a surface – it's called a lux.

As a minimal illumination level on your layout surface, start at ~500 lux. If you want more details to be visible, aim more for ~1000 lux. More on how to compute lux in a bit.

For my layout, I like to use a shadowbox type of construction, with the viewing window being about 13 -15 inches or so.

ADVERTISEMENT

SOLAR SYSTEM SERIES



COMING THIS SPRING!



CLICK HERE FOR MORE INFO

REGISTER (free)

[INDEX](#)

[TABLE OF CONTENTS](#)

2021 will see the dawning of a bigger and better Walthers National Model Railroad Build-Off

Entering lets you

Push out of your comfort zone.

Strike out in a new direction.

Let your mind wander to unexplored creative horizons.

*(oh, and there's that thing
about winning oodles of cash.)*

COMING SOON!

▲ Brandon Lepley of Lewisburg, PA created this stunning entry for the 2020 NMRBO contest.

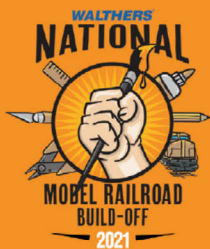

Give a Walthers Gift Certificate to your favorite modeler – the perfect start to creating that winning NMRBO entry.

Planning your entry starts now with a visit to your local hobby shop in person or online to stock up on the tools and supplies that'll turn your ideas into a modeling masterpiece!

Watch for complete contest details and kit packs coming soon.

WALTHERS

©2020 Wm. K. Walthers, Inc.

Making changes is easy with SoftTrak[®]!

Automatically optimizes geometry between track ends and segments, with or without easements or S-curves.

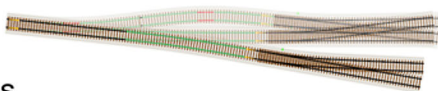

Click here!

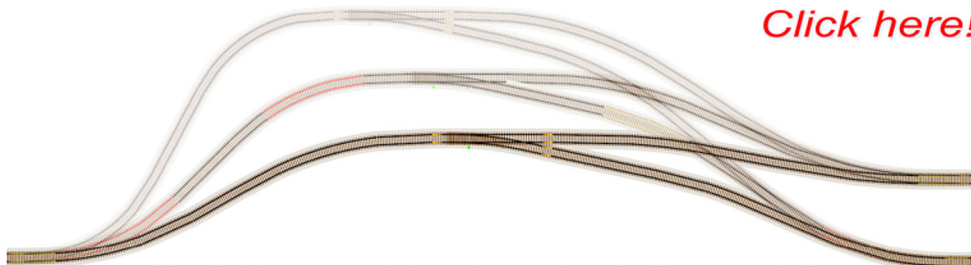

New! Move or rotate a turnout and all connected SoftTrak moves with it, showing radius problems in red. *Refining your design has never been easier!*

3rd Plant 3D CAD
The ultimate track planning software

El Dorado
SOFTWARE
www.TrackPlanning.com

PUBLISHER'S MUSINGS | 3

That may sound small, but if I have the layout height at 50" minimum, then the bottom of the valance comes to 65". Higher deck heights can see the bottom of the valance move to 70" or more in short order.



2. My SL2 TOMA modules on display, with an estimated 1000 lux of light.

If I take that 300 lumens and compute the lux at 14" using the lumens to lux calculator here [dmslighting.com/tools/il-luminationconverter.html], I get about 1000 lux, nice and



REGISTER
(free)

[INDEX](#)

[TABLE OF CONTENTS](#)

**LARGE
SCALE**

The Original
BACHMANN BIG HAULERS

NEW D&RGW™ #170 – FLYING GRANDE
Item No. 91801

Large Scale 4-6-0: Arriving DCC and Sound-Ready

The Backbone of the Big Haulers® Line Returns with New Tooling & Features

Bachmann is excited to announce the return of the 4-6-0 steam locomotive to the *Big Haulers®* line. Featuring a completely retooled tender body with more prototypical details along with metal gears and a durable Pittman® motor, the new ten-wheeler has more pulling power for your Large Scale layout. This locomotive arrives DCC and sound-ready with an advanced nonproprietary plug-and-play circuit board to accommodate the control system of your choice, including conventional DC power, NMRA/NEM DCC, and/or RC operation. Visit your favorite hobby retailer and take one home today!

Features include:

- powerful and durable Pittman® motor
- completely retooled tender body with more prototypical details and coal load
- advanced nonproprietary plug-and-play circuit board to accommodate the control system of your choice, including conventional DC power, NMRA/NEM DCC, and/or RC operation
- factory-installed speaker for easier installation of aftermarket sound systems
- metal gears
- die-cast lead truck
- metal detail parts including: handrails, piping, siderods, and wheels
- separately applied domes and smokestacks
- finescale backhead detail
- LED headlight and back-up light
- smoke unit



D&RGW™ #176 – BUMBLEBEE
Item No. 91803

NEW



PAINTED, UNLETTERED – BLACK
Item No. 91804

NEW



CHRISTMAS NP&S® #1225
Item No. 91805

NEW

Arriving March 2021
MSRP \$999.00 each



Bachmann Industries, Inc. • 1400 East Eric Avenue • Philadelphia, PA 19124 USA • www.bachmanntrains.com

[Click for more information.](#)

MRHMAG.COM

[INDEX](#)

[TABLE OF CONTENTS](#)

bright, actually! To see what this looks like in real life, here are my TOMA modules [2] at the last National Train Show – looks plenty bright to me! So that 300 lumen LED strip works fine.

Notice if I put this LED strip instead behind a valance that's hanging from an eight-foot ceiling, the strip now sits at least 40" above the layout surface for a layout that's at 50" from the floor.

Using the lumens to lux calculator again, I get a bit less than 100 lux, which is way too dim!

It's important to not only know the lumens of output from the LED strip, but to also know how far the light will need to travel to get to the layout surface. Using lumen/lux math, you can pretty much nail the look you're after.

Avoid waterproof strips

You can get LED strips that have a waterproofing plastic coating so they can be used safely outdoors.

However, various modelers have reported the waterproof coating will yellow over time as the heat from the LEDs cause it to change color. Yes, the LEDs don't put out a lot of heat, but with the coating being right on top of the LEDs, what heat there is builds up and yellows the coating.

That yellowing will change the light color of the LED strip, which isn't good news. Long story short: avoid LED strips that have a waterproof coating.

LED strips have what's called an IP (ingress protection) rating. You want an IP of 20 or less to avoid the waterproof coating. An IP of 65 or more has the waterproof coating, so avoid those.

What's a good LED color?

LED strips also come in different color temperatures such as warm white, cool white, and so on. A more precise description of light color uses Kelvin temperature ratings.



Ready to run sound decoder equipped locos, but not ready for DCC?

Tech 6 is the answer

Tech 6 runs standard DC locos and with the push of a button, runs any DCC sound decoder equipped loco, unleashing up to 28 sounds and light functions



Handheld available, not included, allows you to walkaround your layout while operating up to 6 decoder equipped locos, or one standard DC loco. Tech 6 ... *there's nothing else like it.*

**GET THE
DETAILS
HERE**



M O D E L R E C T I F I E R C O R P O R A T I O N

360 Main Street, Suite 2, Matawan, NJ 07747 • Phone: 732-225-2100 • www.modelrectifier.com

FOUNDED BY ROY C. GELBER

■ Train Controls

■ Model Railroad Accessories

■ Plastic Model Kits

■ Scenery

■ Educational Kits

MRHMAG.COM

[INDEX](#)

[TABLE OF CONTENTS](#)

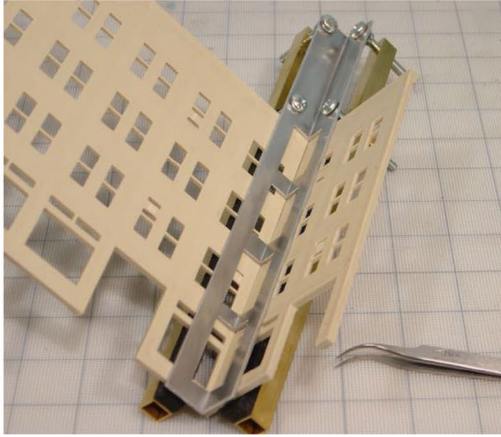
"Right and Splice Clamps"™

Quality Tools with Superior Versatility

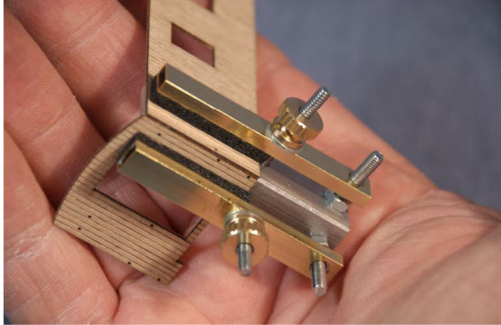

Essential Tools for Great Modeling

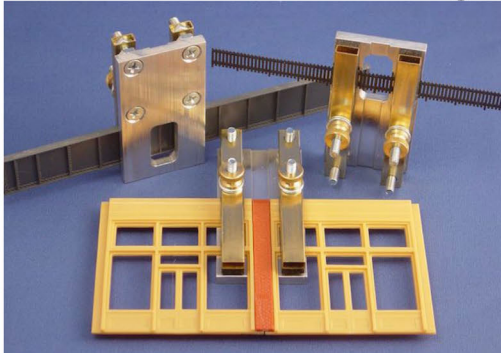

Coffman Graphic Solutions
1500 River Circle, Richmond KY 40475

Click Here

Visit our new Website:
www.coffmaneng.com

A standard incandescent light bulb has a color temperature of about 2700K. See chart [3] for a comparison of the different lighting colors.

Halogen lights come in at about 3200K.

Warm white fluorescent tube bulbs run about 3500K, and cool white fluorescents come in at around 4200K.

Light at around 4000K is considered "neutral white" or "daylight."

Moving up to "crystal white" fluorescent bulbs, their color approaches 5000K. I call it "hospital light" because an area lit with light of this color makes me feel like I'm in a hospital. For me, it's an uninviting light color to use for a layout space.

If you're not sure, 4000K is a good safe light color to aim for.

I personally prefer a warmer white color, say about 3000K. This color feels like a warm summer day to me - which I find gives a quite pleasant look to the layout.



REGISTER
(free)

INDEX

TABLE OF CONTENTS

FAST TRACKS



Build your own trackwork easily, quickly, and affordably.

TRACK BUILDING SYSTEM

★★★★★
Precision milled pockets accommodate PC Board ties that are soldered to the rails.

★★★★★
Track slots ensure perfect alignment while soldering the rails to the PC Board ties.

Each turnout fixture can be used to construct both right and left turnouts that are DC and DCC compatible.

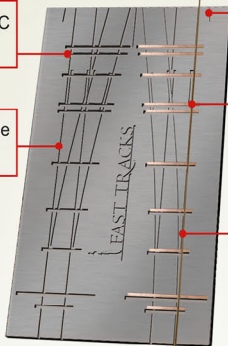

★★★★★
Guard rail forming grooves are provided to precisely shape the guard rails.

★★★★★
PC Board ties are soldered to the rails using a standard 35 watt soldering iron.

★★★★★
Rails are inserted into the fixture right side up, making it easy to confirm alignment.

★ Fixtures are machined out of a solid piece of high grade 6061 aluminium stock and will last for thousands of uses.

Turnouts are built using pre-cut PC Board ties dropped into pockets cut into the fixture.



Held in precise alignment, rail is then soldered in place onto the ties.

The Fast Tracks PointForm tool makes it fast and easy to file perfect frog and switch points for the turnout.



Just insert the rail into the tool and file.

Finishing the turnout is simple with QuickSticks laser cut wood ties.



Simply glue the soldered trackwork to the wood ties, break off the frets, and your turnout is ready to be installed onto your layout!

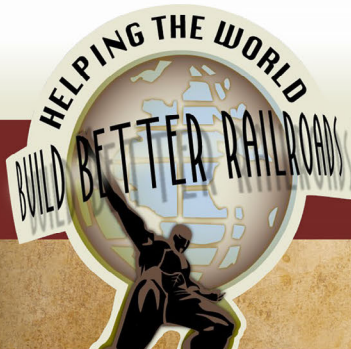

All Fast Tracks track fixtures and tools are NMRA compliant



• Easy ordering •

Earn Waypoints with every purchase

shop online 24/7 handlaidtrack.com

1-888-252-3895 service@fast-tracks.net



3. Light color diagram showing the different Kelvin (K) temperatures of light.

I just feel happy inside when I look at 3000K layout lighting. It's a tad more blue than 2700K incandescents, which look too orange to me. I know Tony Koester said he liked the more bluish daylight color on his previous Appalachian layout because it brought out the greens and increased the sense of being up in the high mountains.

While I'm discussing light color, one notion I've seen thrown around has been using RGB LED strips since you can program those to be any color you want. You can literally have a red sunset look, to a blue moonlight look, all the way to a white light look or anything in between.

In fact, RGB LED strips don't produce a very smooth white light, it's always got a tinge of color to it, especially in photographs. You can run a second strip of RGB LEDs along the valance with a consistent white LED strip. Then use dimmers to control the mix of white light with other colors such as red or blue to get special looks.



HO MODELERS: RESTRICTED ACCESS!



CLICK HERE FOR INFORMATION

CHOOSE YOUR CAB



PRE-PRODUCTION ARTWORK SHOWN

CLICK HERE



REGISTER
(free)

[INDEX](#)

[TABLE OF CONTENTS](#)

I've just scratched the surface

I've just scratched the surface here regarding all the considerations needed to get great layout lighting using LED strips. The strips don't cost too much, especially if you shop online, so get a strip or two and try them out for yourself.

I'm also planning to do a much more in-depth video on Train-Masters TV about LED strip lighting. I will delve into all the different considerations such as double row LED strips, LED color rendering index (CRI), and how to pick a good power supply for your LED strip lights.

I encourage anyone who is using LED strip lights to post their experiences in the reader comments for this article. The collective wisdom you all have can be extremely helpful to the rest of us trying to decide on the best way to go with our layout lighting.

See you online!



A handwritten signature in black ink, appearing to be "John".

Did you see this article?



Neat & tidy DCC
install tricks

In **MRH** **RUNNING**
EXTRA

Get the December eBook now

[click here](#)

Did you see this article?



Archival shelf
liners to prevent
equipment damage

In **MRH** **RUNNING**
EXTRA

Get the December eBook now

[click here](#)



Every little bit helps!

Registered MRH readers get **another** 10% off with the coupon code here:



Unwrap my coupon code now!

[click here](#)

That's right, on top of our holiday discounts, use this coupon code to get **ANOTHER** 10% off the holiday sale price!



Merry Christmas!



TMTV sale offers

[click here](#)



MRH Store sale offers

[click here](#)



REGISTER
(free)

[INDEX](#)

[TABLE OF CONTENTS](#)



LAST ISSUE'S RATINGS

The three top-rated articles in the [November 2020 issue](#) of *Model Railroad Hobbyist* are:

4.7 First Look: miniprints

4.6 Truck painting “jig”

4.6 November 2020 News

Issue overall: 4.6

Please rate the articles! Click the reader comments button on each article and select the star rating you think each article deserves. We depend on these ratings to help us determine which articles to publish, so your rating matters! ■

Get the latest Model Railroading News, Tips, Reviews & Opinions

**CHECK
IT OUT!**



**Our iTunes feed has changed search for
“Crew Call with Mike Rose” to receive the latest episodes!**

www.themodelrailroadpodcast.com

Host:

Mike Rose: www.mrhobby.com

**Don't Miss our Monthly Interviews
& Product Announcements**



NORTH AMERICAN RAILCAR CORPORATION
NORTH AMERICAN RAILCAR CORPORATION

ACCURACY AND DETAIL IN SCALE

Attention Model Railroaders!

National SteelCar 5092 cuft Combo Door Box Cars!

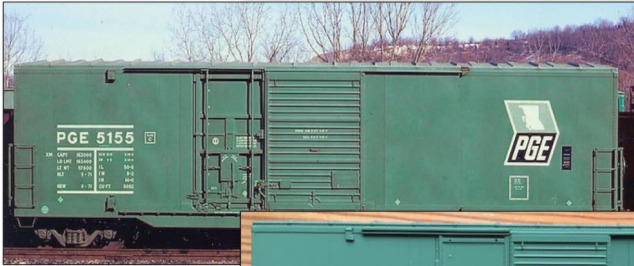

HO \$39.98 USD

N \$29.98 USD

Anticipated Delivery Date: April 2021

To place your orders Click Here

Exclusive to: **Pacific Western Rail Systems**



REGISTER
(free)

INDEX

TABLE OF CONTENTS

Best of the

MRH WEBSITE

Website

MRH
mrhmag.com

THIS
MONTH

Model Railroad Hobbyist | December 2020

Compiled by **JOE FUGATE**

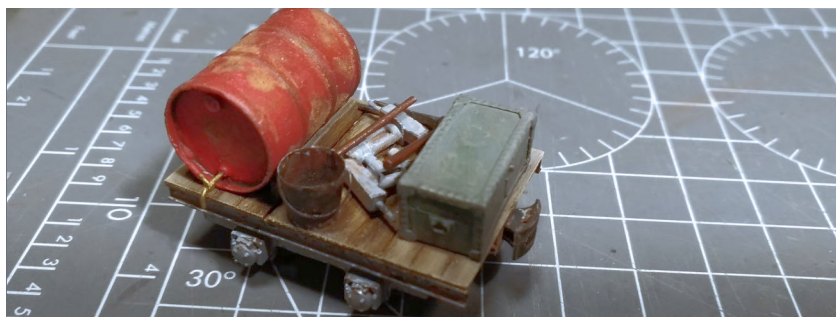

O scale narrow gauge fun

MRH forum member **pby_fr** (Pierre-Yann Bridé) has a long-running blog about his micro-TOMA module that he's doing:

"Yes it is O scale, narrow gauge. More exactly 0e, similar to On30 but with a scale of 1/43.5 (French/British O scale).

I like O scale, especially for the level of detail I can build on the model. I never was able to something like that in HO."

Go have a look and follow along to enjoy some great modeling in a small space!



[View the full thread on the MRH website](#)

▶ **MRH'S MONTHLY GREAT MODELER POSTS**



1. Greg Baker has been experimenting with how to make conifers that have a more realistic needle texture.

Making conifers that have needles

MRH forum member **Mountaingoatgreg** (Greg Baker) decided to explore making more realistic conifers that have a true needle texture:

“I have been honing my skills in regards to making fir trees. I am working on it, I want to make sure I can get consistent results before declaring victory. Once I have mastered my methods I will work on write up. They are getting better.

The paint is still wet on this one, it will still need a bit of a trim when it dries, but this one, this is looking right.”

Check out Greg’s thread to see how it’s coming!

[View the full thread on the MRH website](#)



[REGISTER](#)
(free)

[INDEX](#)

[TABLE OF CONTENTS](#)



Model Train Technology®

Fiber Lighting Controller III - 16 Ports (with Power Supply)



16 Port FIBER CABLE Animation controller can power and animate up to 16 separate single fiber lights. Power, Control and Animate your Fiber Cable. The LSC III replaces over a dozen separate special effects boards costing over \$100!

\$145.00 – \$155.00

Built-in DCC Decoder



NEW!! – Fiber Lighting Dongle™

Connect Fiber Lighting to our LED Scene Controller to Mix and Match LEDs And Fiber

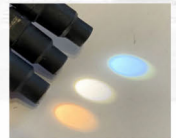

support@modeltrainman.com | (407) 242-5436

ModelTrainTechnology.com



2. Bob Morningstar shows his own spray paint booth and then asked other forum members to share their solutions.

Finding the perfect home made spray booth

Forum member **bobmorning** (Bob Morningstar) describes his approach to making a spray booth:

“I used a plastic storage container tipped on its side, a bright white under kitchen cabinet LED light unit, and a inexpensive bathroom ventilation fan. The 3" ducting is stored in a storage caddy until I extend it out the basement door.

I don't shoot oil based paints (Floquil) any longer, so the lack of an "explosion proof" fan is not a factor.”

Bob then went on to ask for others to share what they have done: many have posted their home made booth designs.

If you're thinking of making your own spray booth, this thread has some great ideas for making one inexpensively.

[View the full thread on the MRH website](#)



REGISTER
(free)

[INDEX](#)

[TABLE OF CONTENTS](#)



Where prototype modeling, operations & technology converge ...

Join us in Santa Clara, California for NMRA's national convention featuring clinics, layout tours, contests, and a great keynote speaker. Enjoy a superior climate, world-famous local attractions and fellowship with your friends.

www.nmra2021.com



LET'S GET LIT!

"If light is in your heart,
you will find your way home."

~ Rumi



Roomettes

Bring Your Structures to Light

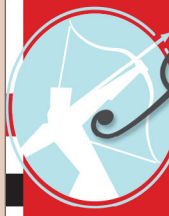

Archer

FINE TRANSFERS
PROUDLY SERVING MODEL BUILDERS SINCE 1989

THE ORIGINAL

SURFACE DETAILS™

WE NOW HAVE MORE THAN 130 SHEETS OF RIVETS, LOUVERS, TREADPLATE, WELD SEAMS AND MORE CAST ONTO MICROSCALE CLEAR DECAL FILM

LOW SHIPPING:

**DOMESTIC USA ORDERS
\$2.80**

**INTERNATIONAL ORDERS
\$9.95**

CLICK HERE TO VISIT OUR WEBSITE!



MADE IN THE USA

Archer Fine Transfers • PO Box 1277 • Youngsville, NC 27596 • USA
(919) 570-1026 • info@archertransfers.com • archertransfers.com

Lasercut structures. Highway, storefront and billboard signs.

Neat as customer for your railroad:
Farmers Fertilizer Supply



WHAT'S NEW?



Established 1993...

Blair Line

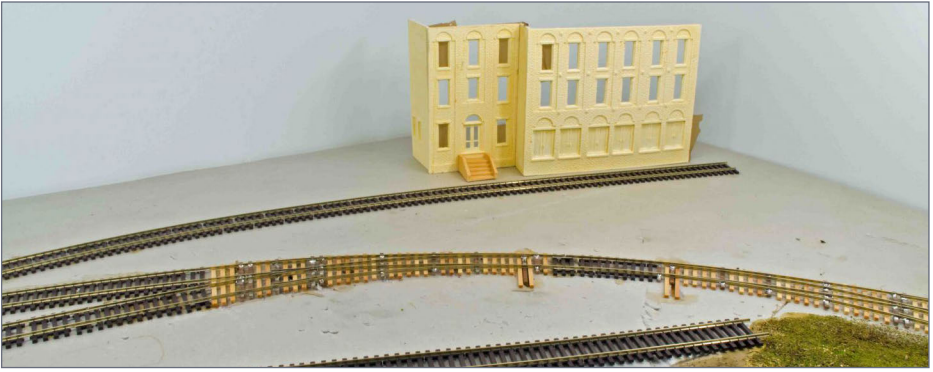

3. Here's a before and after shot of a Cornhill Town urban scene being developed by Rob Clark.

Developing an urban scene, step-by-step

MRH forum member **fernpoint** (Rob Clark) chronicles the process building his Cornhill Towb urban scene on his *MRH* blog.

"I would like a lot more buildings arranged in an interesting fashion (I love Earl Smallshaw's approach), but downtown Chicago it ain't, so I have to be inventive in a very small space."

Visit Rob's blog and follow the progress, step-by-step!

[View the full blog on the *MRH* website](#)



REGISTER
(free)

[INDEX](#)

[TABLE OF CONTENTS](#)

Latest *MRH* Weekly photo fun thread

Every week, a new Weekly Photo Fun thread appears. It's frequently loaded with inspiring photos of great modeling ...

View the full thread on the *MRH* website



4. Forum member [rjthomas909](#) posted a photo of his new Baldwin Frisco diesel, complete with DCC sound. On the bottom, Mark Mathu posted this fantastic lumberyard scene.



RATE THIS ARTICLE

TMTV's *NEW* Backshop Clinic is here!



All about clearances (more than you think!)

BACKSHOP CLINIC

One viewer commented: "I've long used the NMRA gauge, but I never realized all of the different things that were determined by the gauge."

Also recently added new videos ...



Establish a realistic roster



Allagash Carthage Turn



Curves, easements, super-elevation

Watch now ...



7 day rental: 1.99 | buy: 2.99

Or become a member and get unlimited access (500+ videos)



www.trainmasters.tv

Registered MRH reader?

SAVE 10%
click here



REGISTER
(free)

[INDEX](#)

[TABLE OF CONTENTS](#)

WHAT'S NEAT

column



Model Railroad Hobbyist | December 2020



KEN PATTERSON'S COLUMN THIS MONTH ...

- Installing a TCS Trainspeed1
- Using glue to glue coal loads, glue ground foam, and glue ballast
- Merry Christmas!



WHAT'S NEAT!
MODEL RAILROADING
install a train
Speedometer

MRH November 2020 show

PHOTOS AND VIDEO OF SUPERB MODELS

ON THIS MONTH'S WHAT'S NEAT VIDEO, Ken shows how he installed a Train Control Systems (tcsdcc.com) Trainspeed1 speedometer using Deluxe Materials (deluxematerials.co.uk) Ballast Magic and Ballast Bond to glue down ballast, as well as using it to glue some other things.

Installing the Trainspeed1 Speedometer



1. Ken installs a TCS Trainspeed1 speedometer (tcsdcc.com/1547) on his River Diorama in the first segment. Here he uses a caliper to measure out the 7.283" that equals 1/100th of a scale mile in HO scale.



RATE THIS ARTICLE



REGISTER
(free)

[INDEX](#)

[TABLE OF CONTENTS](#)

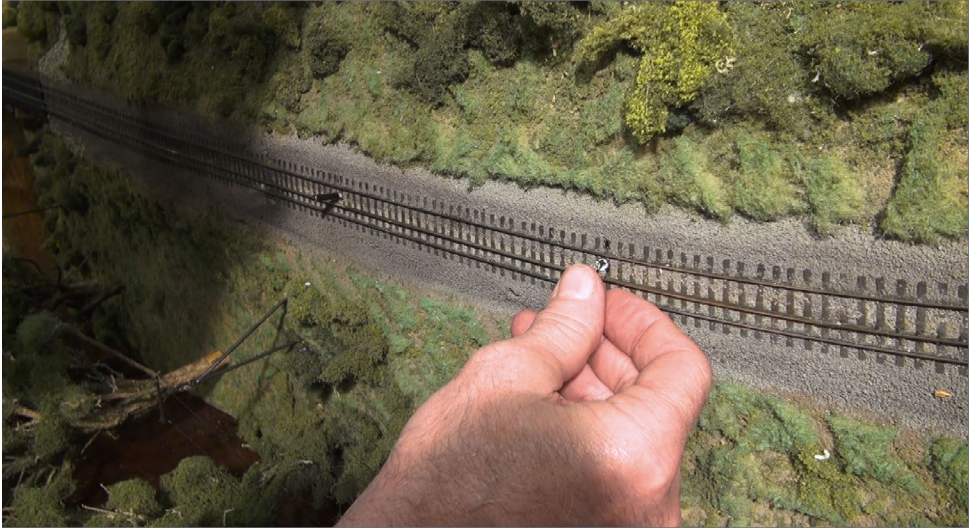

2. Ken installs the sensors between the rails. The speedometer can be used with Z, N, TT, HO, OO, S, O, and G (1:24) scales and with sensor separations of 1/25, 1/50, 1/100 (factory default) and 1/200 of a mile. Kilometers are also supported.

Did you see this article?



The story of modeling six switchers ...

In **MRH** **RUNNING** **EXTRA**

Get the December eBook now

[click here](#)



Also see the "What's neat this week" weekly video podcast!

WATCH NOW >>



3. The display on the speedometer is nearly as thick as the plywood Ken uses as the fascia for his layout. Cutting and filing the correct sized hole was easy.

Did you see this article?



Prepping cars for layout operation

In **MRH** **RUNNING**
EXTRA

Get the December eBook now

[click here](#)

Did you see this article?



Upgrading Mikado #42 into a G&D look-alike

In **MRH** **RUNNING**
EXTRA

Get the December eBook now

[click here](#)



Also see the “What’s neat this week” weekly video podcast!

WATCH NOW >>

 REGISTER
(free)

[INDEX](#)

[TABLE OF CONTENTS](#)



4. Ken spray painted a faceplate for the speedometer, using dry transfer letters for the MPH. The second hole is for an on/off switch. To finish up he repainted the entire fascia with a layer of high-gloss polyurethane.

**Please rate and/or
comment on the articles
in MRH magazine!**

**That helps us better know how to bring
you the most helpful articles possible.**

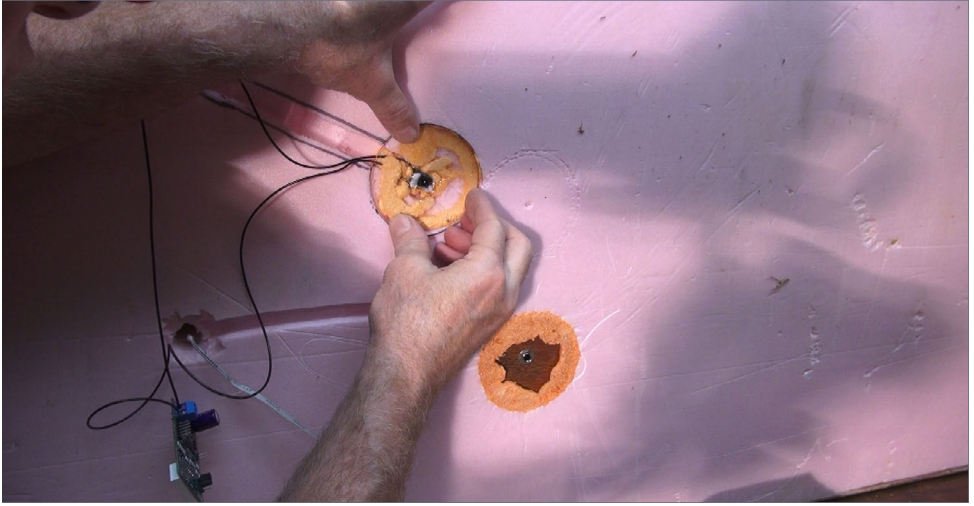

5. Ken salvaged a power socket from an unused electronic device and connected it to the speedometer to make the power connection detachable. Ken excavates the foam bottom of the module for the wire runs and connections so that the bottom will lay flat when he returns it to the layout. Here he uses Great Stuff foam to secure the power socket.

Did you see this article?



A great work-bench tool: the Ultimation sander

In **MRH** **RUNNING** **EXTRA**

Get the December eBook now

[click here](#)



Also see the “What’s neat this week” weekly video podcast!

WATCH NOW >>

 **REGISTER**
(free)

[INDEX](#)

[TABLE OF CONTENTS](#)

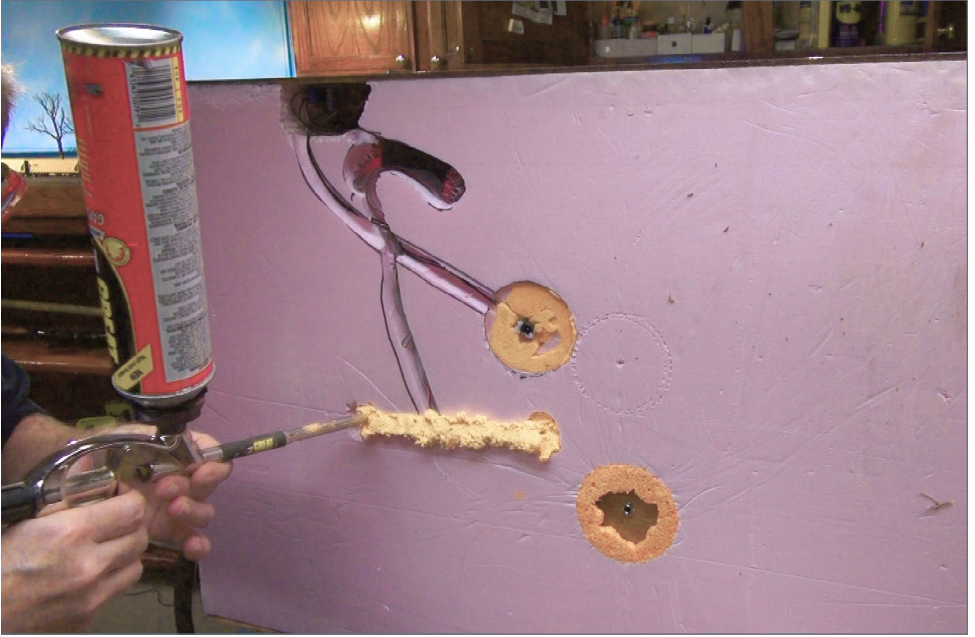

6. Ken fills in the trenches he excavated in the foam with Great Stuff expanding foam.

Tell your friends about MRH!

We depend on word-of-mouth to grow
... if you don't share us, we don't grow



7. After the foam cures, he uses a saw to cut the excess foam off flush with the base of the module.

★★★★★
RATE THIS ARTICLE

Remember to click on the ads!



Also see the “What’s neat this week”
weekly video podcast!

**WATCH
NOW >>**



REGISTER
(free)

[INDEX](#)

[TABLE OF CONTENTS](#)



8. With the module reinstalled on the layout and the power plugged in, it's time for the speedometer to earn its keep.

Did you see this article?



**Modeling a VIA Rail
passenger combine**

Get the December eBook now ← click here

In **MRH** **RUNNING**
EXTRA

Did you see this article?



**Archival shelf liners to prevent
equipment damage**

Get the December eBook now ← click here

In **MRH** **RUNNING**
EXTRA



Bonding rocks and trees with Ballast Magic and Ballast Bond



9. Ken shows how to use Deluxe Materials Ballast Magic powder adhesive to glue ballast down, and then goes on to demonstrate a couple of other uses for it.

Did you see this article?



Neat & tidy DCC install tricks

Get the December eBook now ← click here

In **MRH** **RUNNING** **EXTRA**



Also see the “What’s neat this week” weekly video podcast!

WATCH NOW >>



10. Here Ken has mixed the Ballast Magic with pulverized coal to add a layer of real coal to the top of the molded plastic load, then mists it with water to activate the adhesive.



**DID YOU KNOW
MRH REGISTERED
READERS GET
FREE BONUSES?**

CLICK TO REGISTER NOW - IT'S FREE!



11. Two hours later the coal was solidly attached to the plastic load, without spilled glue damaging the weathering.



Please include a phone number when emailing us if you need a reply!

(Just in case your spam filters eat our email response ...)



REGISTER
(free)

[INDEX](#)

[TABLE OF CONTENTS](#)



12. Ken also demonstrates how he used the Ballast Magic dry adhesive to glue Woodland Scenics ground foam onto a SuperTree. After two hours the ground foam was firmly attached to the tree armature.

Did you see this article?



Layout design using LDEs
(layout design elements)

Get the December eBook now ← click here

In **MRH** **RUNNING**
EXTRA



Also see the “What’s neat this week”
weekly video podcast!

**WATCH
NOW >>**



13. For those who prefer liquid adhesives, Deluxe Materials also has Ballast Bond, which has a wetting agent built into it.

To get more MRH ad-funded pages, please click on the ads.



Also see the “What’s neat this week” weekly video podcast!

WATCH NOW >>



REGISTER
(free)

[INDEX](#)

[TABLE OF CONTENTS](#)



14. Ken demonstrates how to use the Ballast Bond on real rock ballast. The two sections to his right are real rock on the end and Woodland Scenics ballast in the middle, both of which were mixed with Ballast Magic. The Ballast Magic sections were solidly dry in two hours, and Ballast Bond section soon thereafter. Watch the video for how Ken does everything step-by-step.

Did you see this article?



The story of modeling six switchers ...

In **MRH** **RUNNING**
EXTRA

Get the December eBook now

[click here](#)



RATE THIS ARTICLE

From first train set to railroad empire...

*Our complete line of DCC products
grows with you. Discover the fun!*

- Designed and manufactured in the U.S.A.
- Preferred for ease of use and ergonomic design
- Unlimited scalability for any size model railroad
- Plug-and-play means more time running trains
- Great customer service and excellent support



See your dealer



REGISTER
(free)

[INDEX](#)

[TABLE OF CONTENTS](#)



Visit our new and improved web site for all your DCC needs!

- Get the latest new product announcements
- Watch our detailed how-to videos
- Browse the all-new Information Station
- Enjoy secure online sales, day or night!

Visit **ncedcc.com**



**WE MAKE
DCC FUN!**



S T A T I O N

Your one stop shop for:
Digitrax, NCE, Speakers,
SoundTraxx, ESU LokSound,
Train Control Systems (TCS),
Tam Valley Depot (TVD),
& More!

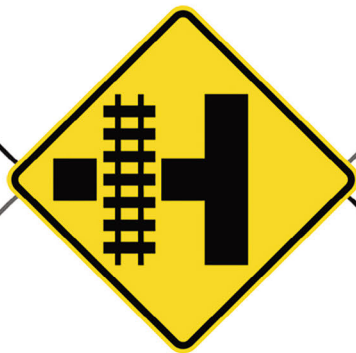

www.LitchfieldStation.com
sales@litchfieldstation.com
623-298-7355



REGISTER
(free)

[INDEX](#)

[TABLE OF CONTENTS](#)

Custom circuit boards

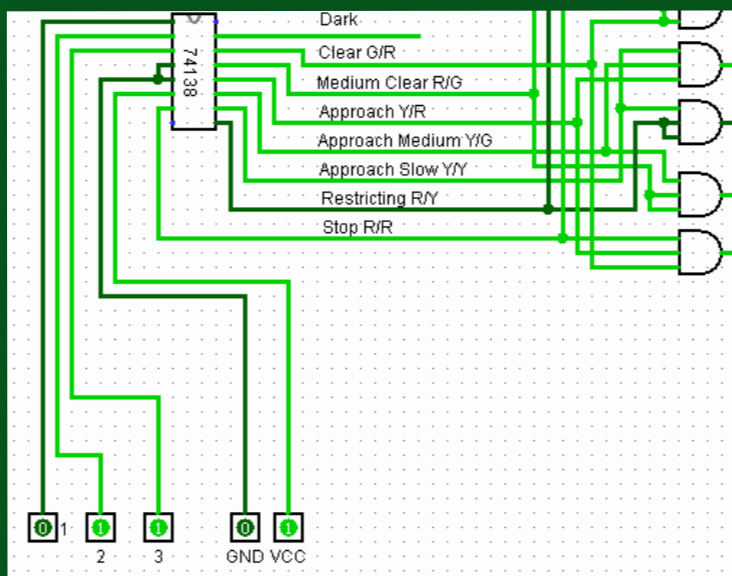

Electrical
Impulses

Model Railroad Hobbyist | December 2020



EARL HACKETT JR. DESIGNS SMALL CIRCUIT BOARDS ...

AFTER READING COMMENTS IN THE JANUARY ISSUE ABOUT DOCUMENTING WIRING and Eagle from Cadsoft (currently owned by AutoDesk), I wanted to share how easy and inexpensive professional quality circuit boards can be produced. If I'm only going to build a single circuit, I'll sometimes hardwire it on a prototyping board. If multiple boards are needed, a custom PC board is the only way to go.

CIRCUIT DESIGN

The first step is to design the circuit and make sure it works as planned. For this I use a little circuit design program called Logisim. It was created by Professor Carl Burch at Hendrix College as an aid in teaching digital circuit design. It's a free download at the Sourceforge website. Google Logisim and you will get plenty of links. Unlike many free programs, Logisim is very capable. It has tri-state components so you can even design a complete computer. If a component is not in the library, you can easily create it by copying the logic diagram from the component data sheet. Professor Burch left Hendrix College some years ago and is no longer supporting Logisim. Development has been taken over by a group of Swiss institutions. The latest version is Logisim Evolution and is available at [Github.com](https://github.com).

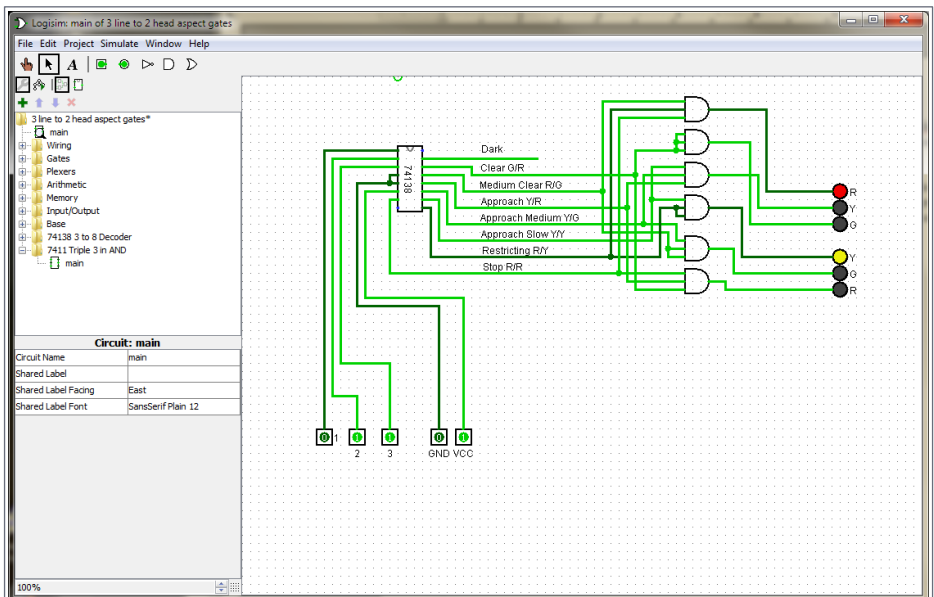

1. A circuit design for signals using a 74138 integrated circuit (IC) chip.

A simple circuit can be created to produce the 1952 C&O aspects for a three-head signal [1]. The 74138 is known as a “decoder.” It accepts a three-bit binary number and activates one of eight outputs that correspond that number. In my circuit [1] these outputs correspond to individual signal aspects (e.g., red/green).

The 74138 is one of many digital integrated circuits in libraries available as free downloads. They are all shown as 74nn series, but you can use whichever family you prefer – LS, HC, HCT, etc.

I've shown the logic portion of the circuit as individual gates. This allows maximum flexibility when designing more complicated circuits. Once you know the circuit works, you can replace the individual gates with ICs, in this case a pair of 7411 triple 3-input gates.

Logisim assumes you know to hook up the GND and VCC pins on the ICs so they are dummy pins in the models. GND and VCC inputs are needed to enable some chips such as the 74138.

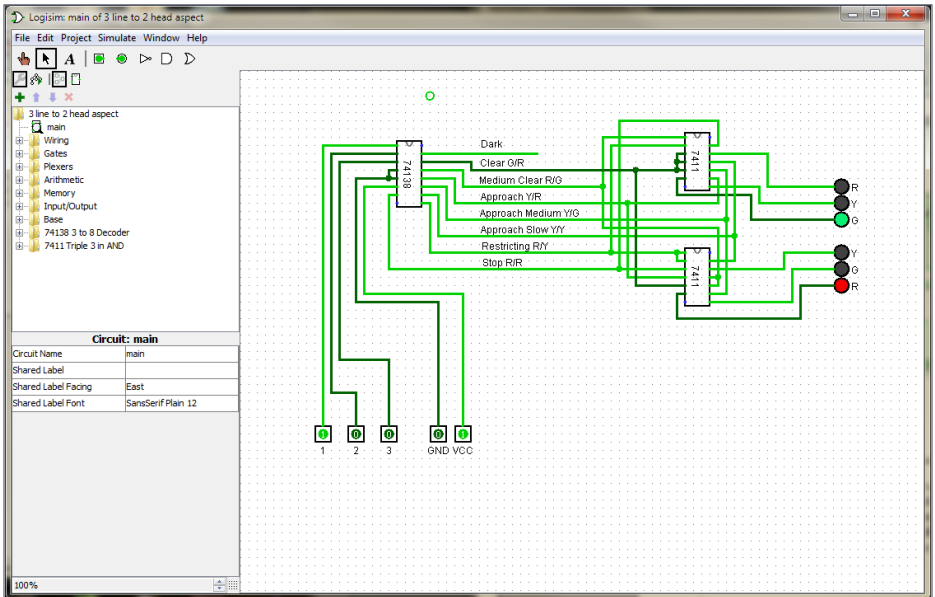

2. Six gates have been replaced with a pair of 7411 ICs.

Drawing [2] is the circuit schematic, which you can test to see if it still has the desired behavior. Once you are satisfied with the design it's time to design the circuit board.

CIRCUIT SCHEMATIC

I like using Eagle v7.3 to design the boards; newer versions may have a slightly different interface. Eagle Lite is a free download of the full program. The only limitation is the board size, about 3" x 4". That doesn't sound like much, but I've crammed as many as a dozen ICs into these small boards. Keeping the board as small as possible also minimizes cost.

Complex ICs like the 74138 are presented in Eagle as a logical image. ICs containing only individual gates are presented as individual gates. This allows you to swap logical gates between physical ICs and swap pins on individual gates to simplify the wiring layout. This is an important feature when wiring a

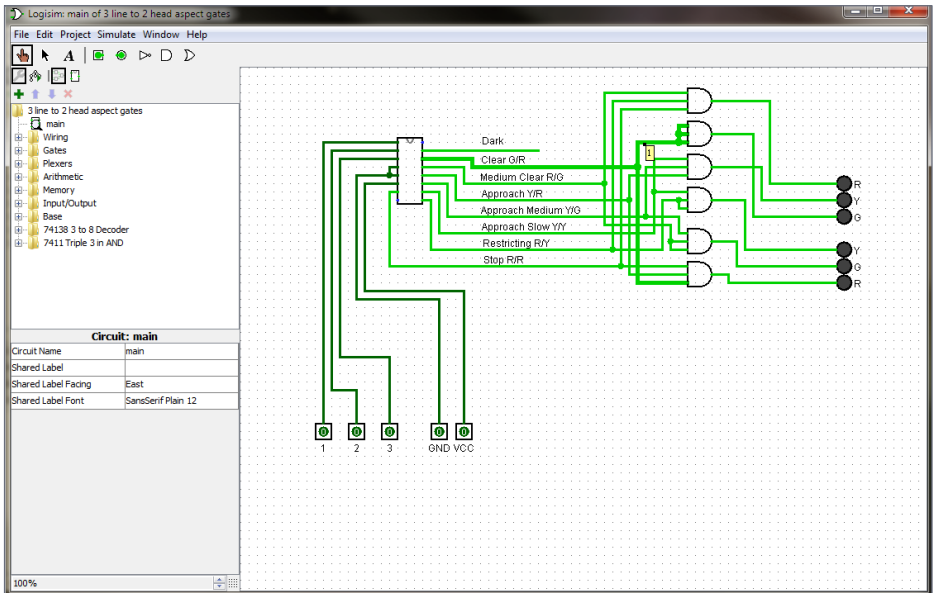

3. Clicking on a wire in the Logisim design software highlights the path.

Great control in a tiny package



**Original
Touch Toggles**

- Touch Toggle™ plug in controls
- Bright clear indication
- Easy setup
- Flexible system

Stall Motors, Twin-coils,
Power, and Servos

Now for Tam Valley Depot
and MRservo too!

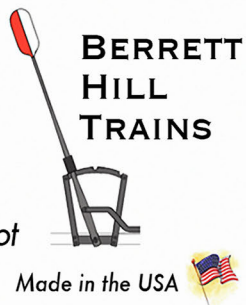

What will they think of next?

www.berretthillshop.com

ADVERTISEMENT

ADVERTISEMENT

TamValleyDepot.com



**Home of the
Frog Juicer**

Our best-selling
Micro Switch Machine

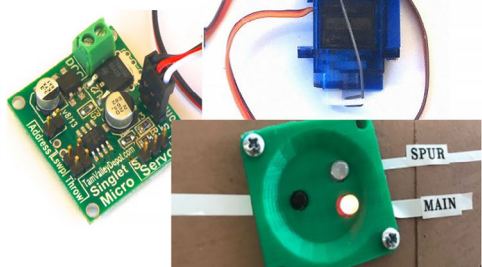

3D Printed Switch Machines and
Fascia Controllers now available



**MAKE YOUR
HOLIDAY
DREAMS
COME TRUE...**

complex logic circuit. We'll switch back to the original Logisim gate format to generate the circuit in Eagle.

A handy feature of Logisim is that when you click on a wire, the entire net is highlighted [3]. This makes it easy to copy the circuit from Logisim into Eagle.

You will need to experiment to learn how the libraries work in Eagle. The biggest problem is finding the desired component. Most libraries have easily understood names, but some are not; headers are in “pinhead” and resistors etc. are in “rcl.” Otherwise

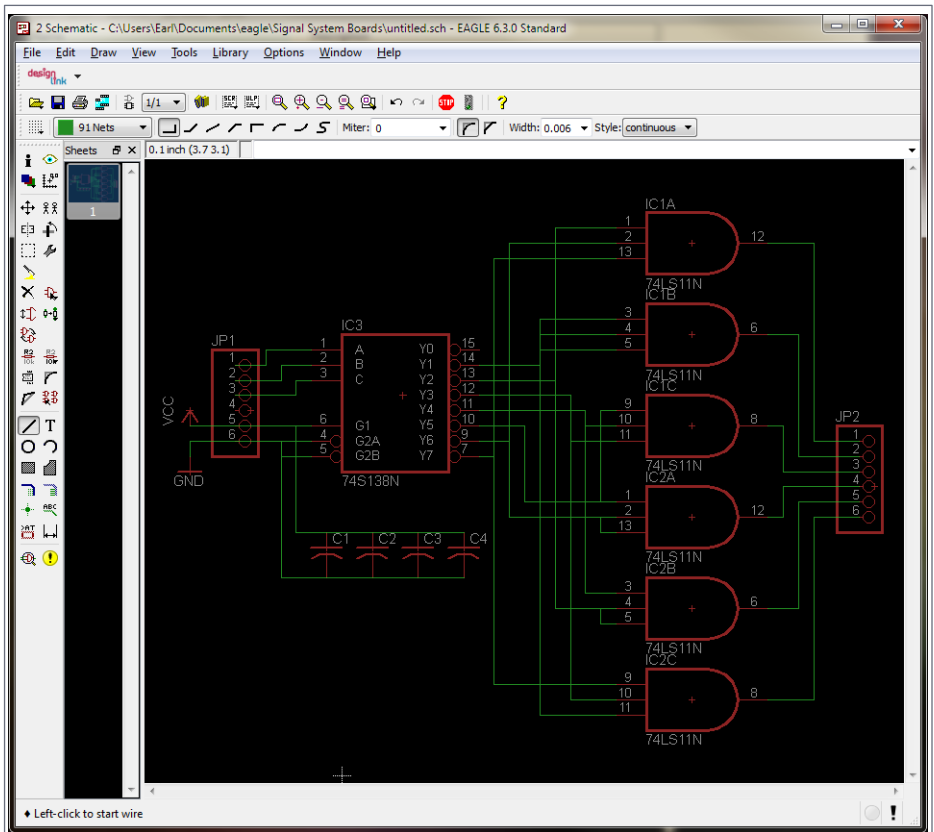

4. The circuit schematic created in Logisim is copied into Eagle to prepare for making the circuit board.

END OF TRAIN DEVICE

NEW SAFETY GREEN



**Bright Red
Flashing Light!**

**Installs in minutes!
No freight car
modification required!**

Patented Technology - US Patent 7,549,609

Does not affect Load!

↓ Car without Load ↓

↓ Car with Load ↓



**Click Here to
Learn More**

**RE RING™
ENGINEERING**

ADVERTISEMENT

Make LocoNet wiring extremely simple!



**Suitcases belong in your baggage cars,
not under you layout!**

**Check out the DCC Vampire II ...
this guy does the job of two suitcase
connectors!
And really holds the connection good
too!**



CLICK NOW TO DISCOVER THE AMAZING VALUE!

Dealer Inquiries Accepted

the interface is like other Windows programs. The Logisim circuit easily copies into an Eagle schematic [4]. The Logisim LEDs and input pins have been replaced with headers that can interconnect with cables going to the physical hardware. I've added filter capacitors that are not on the Logisim schematic but are necessary for reliable operation of the real circuit.

DESIGNING THE CIRCUIT BOARD

Now comes the fun part, converting the schematic to a circuit board. You just click the 5th button from the left on the top bar

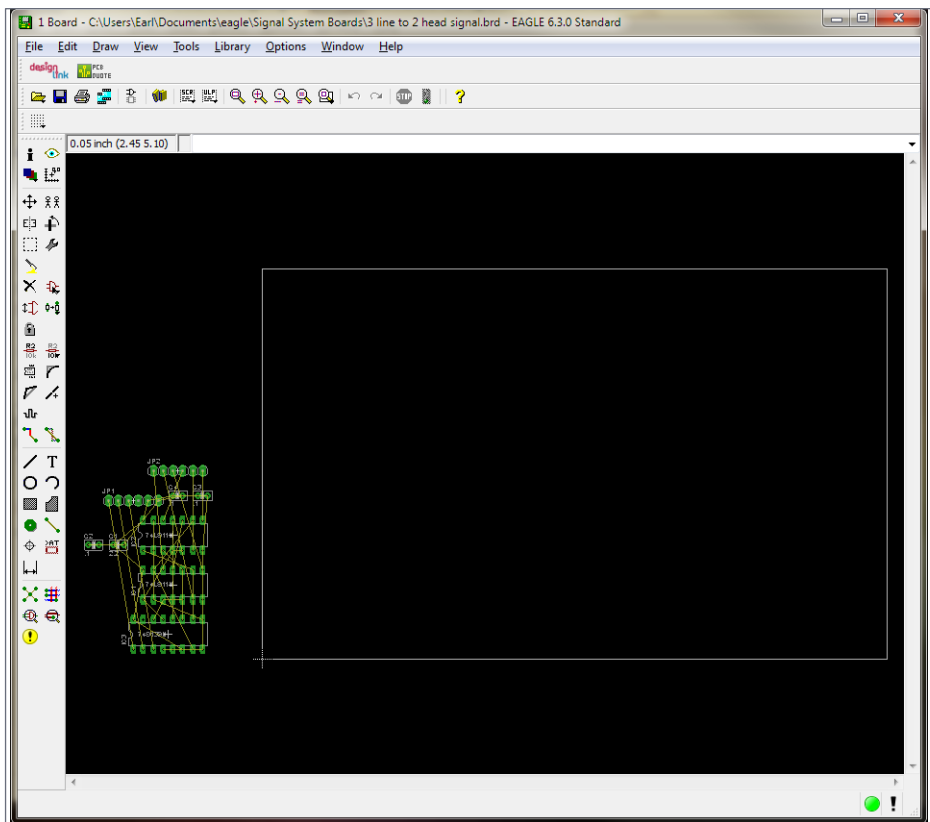

5. The Eagle software positions the components and creates a circuit board outline at the click of a button.



[REGISTER](#)
(free)

[INDEX](#)

[TABLE OF CONTENTS](#)

Your ad here could
reach 65,000+
for as low as \$222
a month.

Click to learn more ...

www.SBS4DCC.com



SOUNDTRAXX

NCE
The Power of DCC



DCC Specialties
INNOVATION FOR DCC



ACCUTRACK II
SPEEDOMETER

SPROG DCC
the DCC Programmer and Control Family

Digital plus
by Lenz

TAM VALLEY DEPOT
Great Electronics for Great Model Railroads

TEAM DIGITAL, LLC
Improving the world of DCC

N - HO - HO_n3 Scale Trains

ADVERTISEMENT



Introducing
T-H-E
LUMBER STORE

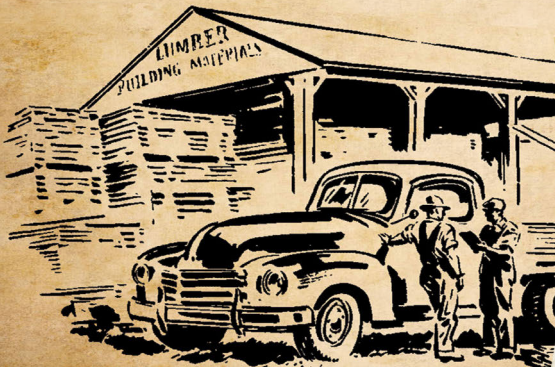

ROTATING STORAGE RACK

On its own, or fully loaded with Mt. Albert Scale Lumber!

handlaidtrack.com

1-888-252-3895

MRHMAG.COM

[INDEX](#)

[TABLE OF CONTENTS](#)

and Eagle creates the board outline and loads the parts off board for you to position [5].

That's a big board for such a small circuit so we'll shrink it. The next thing to do is position the components on the board. You can play around with them to minimize wires crossing each other. In this case I'll put the header connections on either end of the board. Eagle comes with an autorouter; software that automatically runs the wiring traces for you.

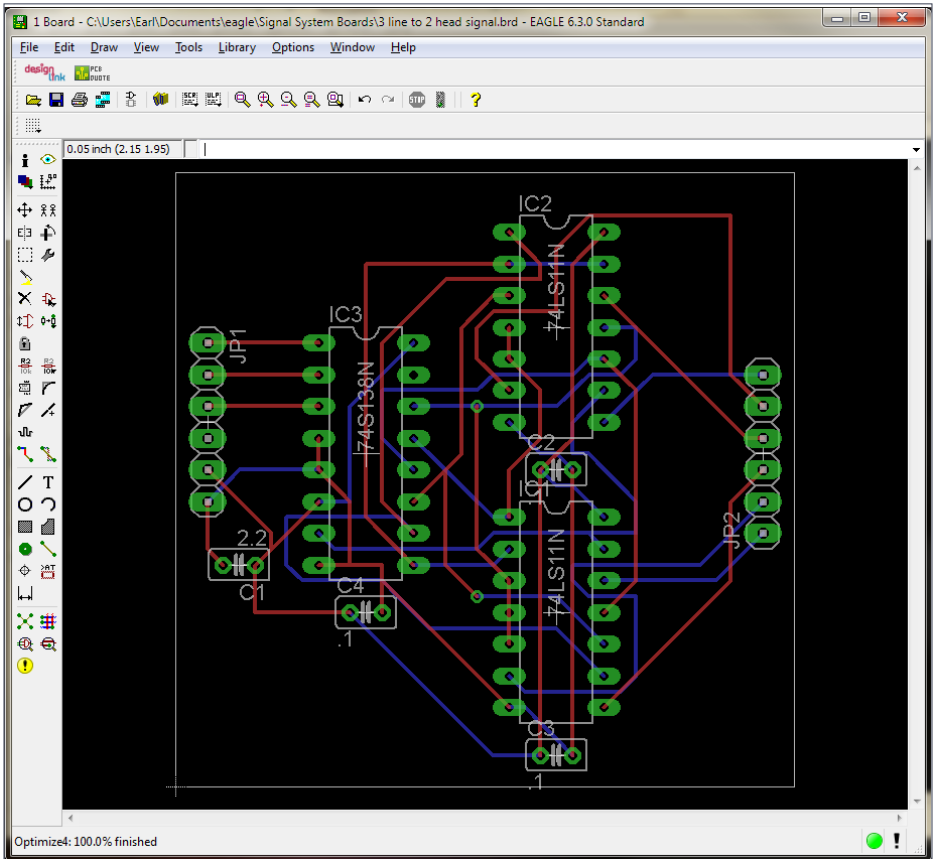

6. The components are positioned on the circuit board to minimize wire crossings. Connections are made with the Autorouter feature.

RailProTM**NEW
TECHNOLOGY****RE RING**TM
ENGINEERING

DCC + RADIO CONTROL

HO Scale Locomotive Module

**ULTIMATE
SERIES
SOUNDS****TRUE
MOTION
TECHNOLOGY****LIGHT
EFFECT
EDITOR**

New Sound Technology and Mathematical Model Motion Control + more!!!



+

Equals
"DUAL MODE"
Control by DCC +
Radio Control**Click Here to
Watch Video**For more information visit our Internet site: www.RingEngineering.com

ADVERTISEMENT

Tsunami2 MEETS N-Scale!

Finally, you can get the Tsunami2 features you have been wanting in your N-Scale locomotives!

We are excited to introduce a Plug and Play Tsunami2, N-Scale decoder and installation kit. The new TSU-KN1 is designed to fit into Kato N-Scale E, F-units, PA and P42 locomotives.

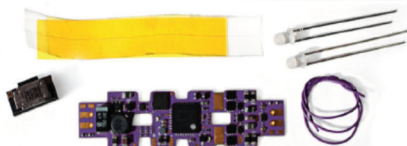

Get an easy install and the amazingly realistic sounds and features that all Tsunami2 decoders have to offer.

Shop at soundtraxx.com or your local retailer today!



Southern Digital

WWW.SODIGI.COM

Celebrating 28 Years serving you



New Items from Digitrax just in time for the Holidays



Evolution Express Duplex Radio
List \$645, Your Price \$516



Evolution Express
List \$460, Your Price \$365



DT602D Radio Throttle
List \$260
Your Price \$208



UT6D Radio Utility Throttle
List \$170
Your Price \$136



DT602 Super Throttle
List \$195
Your Price \$156



UT6 Utility Throttle
List \$105
Your Price \$84



UR93 Duplex Receiver
List \$125
Your Price \$99.95



BD4N Block Detector
List \$36
Your Price \$29



BXPA1 Auto Reverser
List \$49
Your Price \$39



**Ni-MH Battery for
DT602 or UT6**
List \$12
Your Price \$9.60

DCC Conversions, Service & Support

E-mail: sales@sodigi.com (770) 929-1888



REGISTER
(free)

[INDEX](#)

[TABLE OF CONTENTS](#)

Thanks, autorouter. That's one ugly circuit board [6], but it works. I prefer to hand wire my boards so the traces follow logical patterns. I use slightly heavier traces than the autorouter and all traces between pads are on the top (red) surface so there is less chance of a solder short than if no solder mask is used. This makes it easier to troubleshoot a circuit problem later. I also like to keep the trace length between the 0.1uF filter capacitors and the VCC and Ground

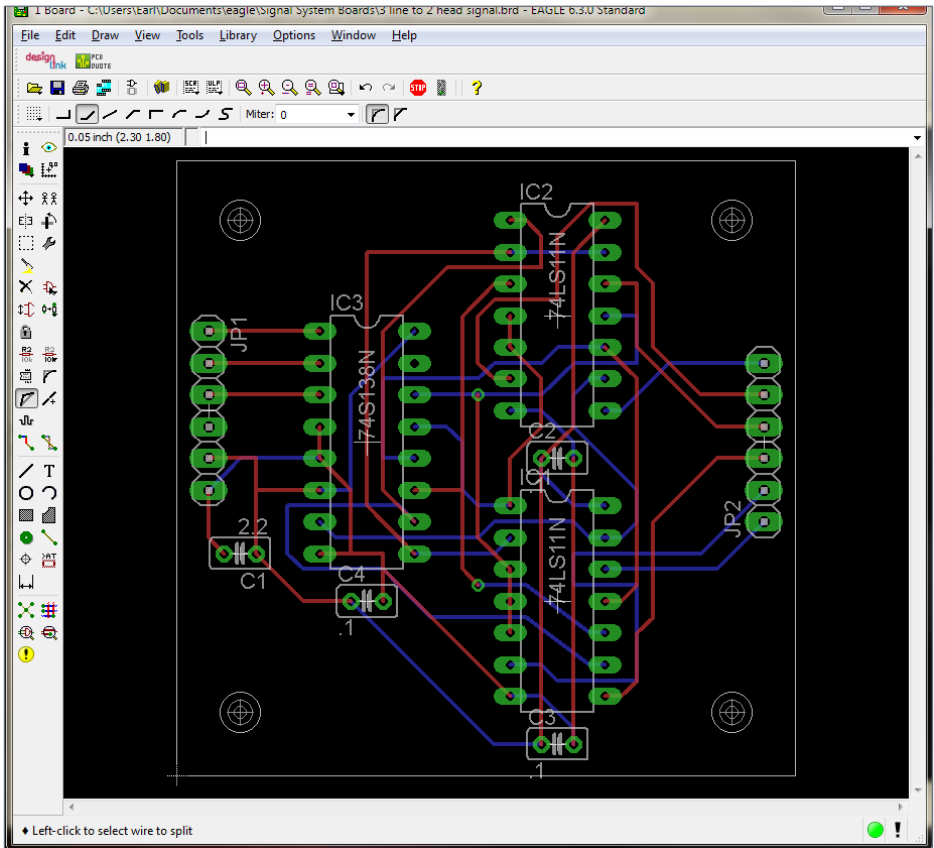

7. The connections to the solder pads are cleaned up. Four 0.125" mounting holes for #4 machine screws have been added. The board design is now ready to be sent to a PC fabrication shop.

Don't settle for all your locos
sounding the same!

ESU now has **OVER 100**
"LokSound" files to choose from!

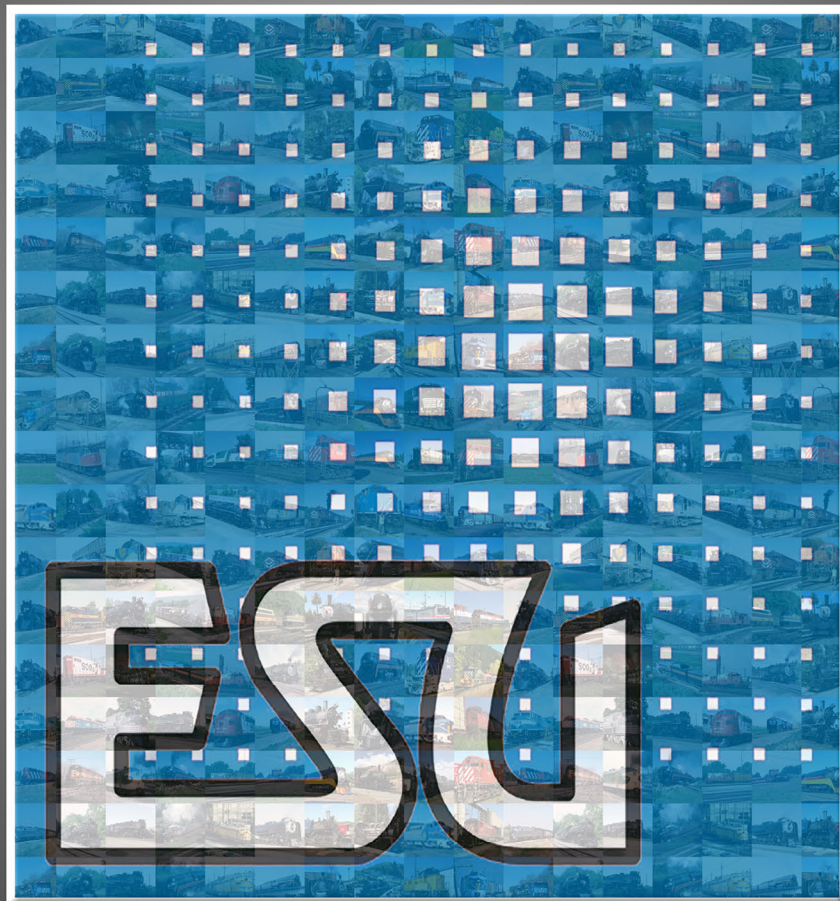

Because "Close Enough" is no longer
"Good Enough"

LokSound.com



[REGISTER](#)
(free)

[INDEX](#)

[TABLE OF CONTENTS](#)

pins to its IC as short as possible. The autorouter doesn't understand this and sometimes makes a mess.

Of the inexpensive off-shore board shops, Pcbcart (pcbcart.com) has the best combination of low price, quality, and customer service. Many shops, including Pcbcart, request you send the Gerber files used to create the artwork for the board. Eagle generates these files in the CAM processor under the files tab. You should ask the board shop which version of the files they prefer. When ordering from overseas, the board cost is low, but transportation costs are high – air freight across the Pacific. On small orders transportation can cost as much as the product. You should compare total costs with some North American suppliers. I have used both Advanced Circuits (pcbnet.com) and Accutrace (pcb4u.com).



RATE THIS ARTICLE

EARL HACKETT JR.

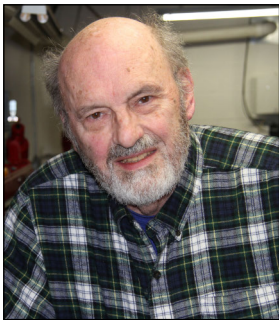

Earl has lives on the East Coast, and has been fascinated by trains from childhood.

Earl is a retired DuPont chemist, and very loosely models the Chesapeake & Ohio from Ronceverte to Allegheny summit in October 1952. He scratch-builds almost everything and is constantly experimenting with different materials and techniques. He has a collection of metal and wood working machines and to him it's more about the journey than the destination. ■



Zephyr Express, the Fast Track to Digitrax Complete Train Control

- **3.0 Amp LocoNet Command Station, Booster, & Throttle**
- **Color 2.4" LCD Screen**
- **Large Backlit Keypad**
- **Runs up to 20 Loco addresses and throttles**
- **Integrated USB Computer Interface**
- **Control lights and sound with 29 functions**
- **Simple Set-Up with Easy to read display**

Find out more @ www.digitrax.com/dcs52



REGISTER
(free)

[INDEX](#)

[TABLE OF CONTENTS](#)

Introducing



\$235.00 MSRP

MRH MARKETPLACE



NEW LOADS ADDED
MONTHLY



CLICK
HERE

HAND MADE
HO & N LOADS

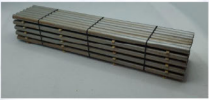

CGMODELTRAINS.COM

**Make your model railroad
layout come alive.**

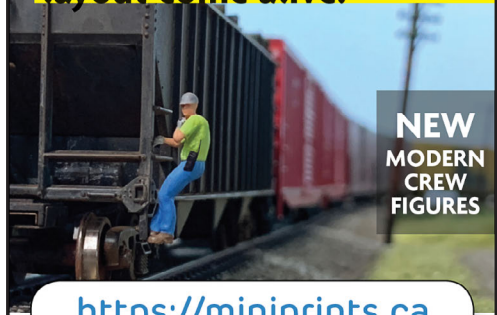

**NEW
MODERN
CREW
FIGURES**

<https://miniprints.ca>

Craftsman-quality custom figures
N, HO, S and O Scales

mini prints
it's the little things that matter the most

click to learn more!

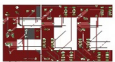

East Coast Circuits
Innovating Your Model Railroad Layout

P.O. Box 25412
Providence, RI 02905

Lighting Circuits For Your Layout

Random Lighting Circuit - Burning Fire Circuit
Traffic Light Circuit - Crossing Signal Circuit

Custom Lighted Vehicles
HO & O Scale Emergency Vehicles
HO & O Scale Trucks & Cars

Eastcoastcircuits.com

Eastcoastcircuits@gmail.com

Out with the old, in with a NEW generation!



Signal Animator/2
Block Animator/2
Grade Crossing Pro/2



New features, improved detection!

Please visit our website and online store!

LOGIC RAIL™
TECHNOLOGIES

info@logicrailtech.com

(281) 251-5813

www.logicrailtech.com

INTER-ACTION
Hobbies

Rail and Tie Craftsman Kits

**When Details
Matter!**



Kit HO-3106

Portable Train Station

www.interactionhobbies.com



REGISTER
(free)

INDEX

TABLE OF CONTENTS

LOOK
at what's new at
Black Cat this month

Click here for
our website

CPR

reweigh data every
month in 5 year blocks:
CPR#1945RW- 1945-1949
CPR#1950RW- 1950-1954
CPR#1955RW- 1955-1960
CPR#1970RW- 1970-1974

Black Cat Publishing
(204)489-5005
ajfergus@mymts.net
blackcatdecals.com



**NEW KIT: AT&SF
Fe-Q/Fe-R/Fe-V**



westerfieldmodels.com

Humancity Junction

Model Railroad Videos | Tutorials, Reviews, Interviews, Hangouts

YouTube Channel Sponsored By

CMR Products | 7% off on House Brands

Iron Planet Hobbies | 10% off and Free
Shipping in the USA

Use Discount Code "HUMAN"

Please visit us out at www.humancityjunction.com

MONASHEE

LASER

ENGINEERING

MANUFACTURERS OF FINE RAILROAD
STRUCTURES AND ROLLING STOCK MODEL KITS

**COME VISIT US
CLICK HERE**



P.O. Box 6 Paonia, CO 81428

Ph. 970 527 4586

Made in The USA

Cast resin items for All Scales.

Tunnel portals, bridge piers, abutments,
culverts, and retaining walls.

Trackside details and sage brush tree
armatures.

"FREE SHIPPING see website for details"

Great Decals!™

FEC, Interstate, Virginian
Railway, & L&N Titles
After Hours Graphics Line
Coupler Gages and More
In O, S, HO, and N Scales



**WEATHERING
POWDER**

**MONROE
MODELS™**

www.monroemodels.us

MOUNTAIN SUBDIVISION HOBBIES

www.modelrrsupply.com

FREE USA SHIPPING OVER \$49.00

MRH Readers save with code:

MRHMAG19

click me!

Pursuing
Excellence



THE TRAINMASTER, LLC

Detailed Craftsman Kits

www.TheTrainMaster.com



Model Railroad Control Systems

Geoff Bunza Project Boards

DCC Occupancy Detectors

CMRnet Compatible Nodes

Layout Telephone Systems

RFID Switchlist Generator

Switch Machines and Drivers

Click Here 

Your ad here could reach 65,000+ for
as low as \$58 a month.

Click to learn more ...

Have you seen these popular blogs on the MRH website?



Tom Johnson's L&IN

485,000 reads

CLICK TO READ IT NOW 



Ken Glover's Shelf Layout

206,000 reads

CLICK TO READ IT NOW 



REGISTER
(free)

[INDEX](#)

[TABLE OF CONTENTS](#)

Floquil/PollyScale stash running out?



MRH has mapped the old familiar colors to readily-available acrylic paints.



MRH's Floquil / PollyScale Paint Equivalents Conversion Chart - 1

Floquil / PollyScale Color (approx.)	Model Number	Yulex/Moncler	WOOX/Max	Notes
Primer Gray	MR 4763	VWA 71505	16-12	
Engine Black	MR 4888	ML 20038 VWA 71321	16-01	
Stream Flower Black	MR 4952	VWA 71657	16-44B	
City Black	MR 4793	VWA 71621	16-44*	
Weathered (Chemical) Black	MR 4950	ML 20032 VWA 71484	16-05	
Reflex Gray	MR 4887 MR 4941	VWA 71045	16-04	
Reflex White	MR 4872	ML 20004 VWA 71035	16-02	
Grass Black	MR 4883	ML 20002 VWA 71036	16-03	
Cobaltum Red	MR 4827 MR 4831	MR 4833 with 20% black pigment VWA 71043 VWA 71042	16-08	

*Indicates a close but not exact match. All WOOX/Max paints are a sampling finish.
 *Yulex Model Art series. ML 20002 and ML 20003 series are the closest equivalent.
 *Yulex Moncler series. Reflex Gray is a shade lighter than the old PollyScale Reflex Gray.
 *Yulex Moncler series. Cobaltum Red is a shade lighter than the old PollyScale Cobaltum Red.
 *Color 4833 has pigments that give it a close match to the old PollyScale Cobaltum Red. Add a bit of medium to get some gloss.

MRH's Floquil / PollyScale Paint Equivalents Conversion Chart - 2

Floquil / PollyScale Color (approx.)	Model Number	Yulex/Moncler	WOOX/Max	Notes
Tuscan	MR 4050*	VWA 71506	16-15	
Reflex Orange	MR 4882*	VWA 71043	16-09	
Reflex Yellow	MR 4879	VWA 71038	16-10	
Roof Brown	MR 4864	ML 20009 VWA 71349	16-16	
Railroad Te Black	MR 4885	ML 20003 VWA 71484	16-06* Closest match... See MR 4827 for 16-04	
Rail Brown	MR 4708*	ML 20001 VWA 71039	16-13	
Rust	MR 4825	ML 20005 VWA 71037	16-12	
Concrete	MR 4876	VWA 71242*	16-11*	
Agate Concrete	MR 4875	ML 20007 VWA 71043	16-09*	Closest match... See MR 4827 for 16-04

*Indicates a close but not exact match. All WOOX/Max paints are a sampling finish.
 *Yulex Model Art series. ML 20002 and ML 20003 series are the closest equivalent.
 *Yulex Moncler series. Reflex Orange is a shade lighter than the old PollyScale Reflex Orange.
 *Yulex Moncler series. Reflex Yellow is a shade lighter than the old PollyScale Reflex Yellow.
 *Yulex Moncler series. Roof Brown is a shade lighter than the old PollyScale Roof Brown.
 *Yulex Moncler series. Railroad Te Black is a shade lighter than the old PollyScale Railroad Te Black.
 *Yulex Moncler series. Rail Brown is a shade lighter than the old PollyScale Rail Brown.
 *Yulex Moncler series. Rust is a shade lighter than the old PollyScale Rust.
 *Yulex Moncler series. Concrete is a shade lighter than the old PollyScale Concrete.
 *Yulex Moncler series. Agate Concrete is a shade lighter than the old PollyScale Agate Concrete.
 *Yulex Moncler series. Cobaltum Red is a shade lighter than the old PollyScale Cobaltum Red.

MRH Registered Readers: Download your FREE Post-Floquil acrylic painting eBook

**Want a hardcopy version?
 Post-Floquil acrylic painting guide: \$16.99 (MRH Store)**

Making your own ballast



1. I took this photo in Kansas City from the walkway over the railroad tracks near Union Station. Note the variation in ballast colors and textures. The closest track looks like a medium grain tan-gray with debris and color stains. The next track looks lighter and more unkept, with a finer grain. The “high iron” looks much better kept, but the darker tan-gray grain looks much more coarse.



[REGISTER](#)
(free)

[INDEX](#)

[TABLE OF CONTENTS](#)

Joe Fugate shows how you can make your own stone ballast for any scale and any color ...



BACK WHEN I WAS DEVELOPING MY ZIP BALLASTING PROCESS, I found that some hobby ballast isn't made from stone but from crushed walnut shells. This ballast tends to be rather light-weight and will easily "float" in liquid ballast glue mixtures.



I know you can buy real stone ballast from a number of vendors such as Arizona Rock and Mineral, but I wanted to see if I could make my own stone ballast from fine sand. I also thought if I could find a very light whitish sand, I might be able to make it any color I needed.

Sand tends to be fairly inexpensive, so I thought I might be able to make a lot of stone ballast for a quite affordable price.

START WITH THE PROTOTYPE

It's best not to work from your imagination on this, but like all good modeling, use prototype references. Take photo [1], notice how much variation you can see in the ballast across just three side-by-side tracks in Kansas City.

The third track from the left with the best manicured ballast also has the most coarse looking grain. The leftmost track has what looks like a mix of dirt and fine ballast, with some very coarse stone randomly mixed in here and there.

Finally, the second track from the left has a consistently fine light-colored ballast with the least manicured look. All that in just one location in Kansas City!

So how large are real railroad track ballast aggregate grains supposed to be? I did some research to find out.

In [2], you can see the various AREA ballast grading sizes from coarse to fine. The more coarse sizes such as AREA 3 seem to



have been used more on mainlines in the past (prior to 1970). The finer sizes such as AREA 4 appear to be used more consistently for mainlines today (after 2000).

Studies done by the railroads have shown ballast that's more varied in size but not too large tends to have a longer service life. In the past before these studies, railroads used more consistently larger ballast sizes in general.

The finest ballast sizes, AREA5 and AREA57, tend to be used mostly in yards and on industry spurs.

Also note, these are "nominal" ballast sizes, which means a few of the stones may be slightly outside the bounds of the sizes shown, especially on the small end. For instance, AREA4 may actually have a small number of 1/2" stones mixed in, making the total mix more like 1/2" - 1-1/2" in size.

It also seems in the classic railroad era (before 1970), the ballast tended consistently toward the large end for the mix. That means AREA3 likely had more 1-1/2" and fewer 1" stones on the bottom end, making classic era ballast mostly 1-1/2" - 2" ballast stones.

Grading	Smallest	Largest
AREA 24	3/4"	2-1/2"
AREA 25	3/8"	2-1/2"
AREA 3A	1/2"	2-1/2"
AREA 3	1"	2"
AREA 4A	3/4"	2"
AREA 4	3/4"	1-1/2"
AREA 5	3/8"	1"
AREA 57	3/16"	1"

2. American Railway Engineering Association (AREA¹) ballast size specifications, in order from coarse to fine.

1. AREA merged into the American Railway Engineering and Maintenance-of-Way Association in 1997 and is now known as AREMA.

For modeling purposes, I've simplified table [2] down into what I'm calling "Classic" and "Modern" era ballast sizes in [3]. I'm defining classic as pre-1970 and modern as since the year 2000. If you're modeling an era in between 1970 and 2000, then either ballast size works, just take your pick.

Prototype ballast size		
Classic	1-1/2"	2"
Modern	1/2"	1-1/2"

3. For modeling purposes, we can simplify [2] to just these era-specific ballast sizes.



4. Now that we know the various prototype ballast grain sizes, we can see from this 1990's photo along the SP Siskiyou Line that the ballast looks to be about 3/4" to 1-1/2" or AREA4.



PROPER MODEL BALLAST SIZE

Now that we know the size of prototype ballast, let's see what size that translates into for modeling.

Let's start with HO. Two inches in HO is about 0.020" and half an inch in HO is about 0.005." So for the classic era, we're looking at ballast grains from 0.015" to 0.020" – and for the modern era, we're looking at ballast grains from 0.005" to 0.020."

Since I'm doing stone ballast, then we're talking about a fine sand with grains at 0.020" and below, but not so fine they just look like powder.

In fact, back in the 1970s, the NMRA Bulletin published a study done of ballast grain size and which size "looked right." The study found that especially in the "small scales" (HO and smaller), fully scale ballast grains at 1" and below start to look like powder and not like gravel when viewed from the aisle.

The NMRA Bulletin article made the case that slightly oversized ballast (2-4") actually has a more realistic granular texture and looks less like just a gritty powder.

Getting the right sand granule size

I found it easiest to get the proper ballast granule size by using sifters intended for mineral panning.

Mesh	Max	Avg	Min	Z	N	HO	S	O
20	0.050	0.040	0.034	9"	6-1/2"	3-1/2"	2-1/2"	2"
30	0.033	0.029	0.026	6-1/2"	5"	2-1/2"	2"	1-1/2"
40	0.025	0.022	0.020	5"	3-1/2"	2"	1-1/2"	1"
50	0.020	0.018	0.017	4"	3"	1-1/2"	1"	3/4"

5. Various sifting mesh sizes have these granule sizes that they pass. The right shows the approximate scale size in inches. The light orange boxes represent the size sweet spot (see text).



6. I bought this set of mineral sifters to use for sifting the various bags of sand to get the granule size I needed. The numbers 20, 30, 40, and 50 give the mesh-per-inch screen size, with larger numbers being a smaller screen mesh.

I bought a set of mineral sifters on Amazon in various mesh sizes listed in this table [5] (see the end of the article for a shopping list). I computed the approximate scale granule size represented by each mesh size and from there I could decide how to sift the sand to get a ballast size that looked best.

In setting the “ideal” granule size, I used the idea that slightly oversize actually looks better – so I marked those sizes with a light orange color on the table.

I had previously used Woodland Scenics fine ballast and I checked it with the sifters and found it’s all about 40 mesh, or ever-so-slightly smaller than ideal for HO (again, the “slightly oversize looks better” finding in the NMRA Bulletin article).



I'm aiming more for 30-mesh and smaller with my homemade ballast, which per table [5], hits the light orange sweet spot size. Notice after 1970, railroad ballast studies revealed a broader range of granule sizes actually helped the ballast have a longer service life.

In terms of the mesh sizes, then ballast granules that sift through 30-50 mesh will fall within the 1-1/2" to 2-1/2" range, slightly oversized but big enough to look like gravel and not powder in HO. Anything that doesn't fall through the 30 mesh sifter is too large and gets set aside for general scenery use and discarded as HO track ballast.

If you're modeling in a scale other than HO, then just use table [5] to determine the size that's correct for your scale. With N scale for example, I'd go with sand granules that pass through a 40 mesh sifter.

Finding the right sand source

With a target sand granule size in mind, I began searching for a good inexpensive sand source. Since I know I'd like to color the sand myself, I research coloring sand enough to know my best sand should be a very light buff or off-white color.

I started looking online for sand sources. I first checked the DIY home hardware stores like Home Depot and Lowes.

I found I could not trust the photos of the product to be accurate (which is too bad). For example, I found some Sakrete play sand on the Lowes website that appeared to be a fine buff colored sand [7] per the bag photo.

Once I got a bag (\$5, so it's literally dirt cheap), it turns out to be more of a darkish warm gray fine gravel than the buff colored sand on the bag [8]. Not at all the light colored fine sand I had hoped I was getting!

7. The photo on this bag image for Sakrete play sand (from a Lowes online listing) looks like a fine buff-colored sand. However, see [8] for the actual color and granule size.



8. The Sakrete play sand on the left came from Lowes and does not at all match the online item listing as to color or texture. It's more of a warm gray fine gravel than the fine buff-colored sand on the bag [7]. On the right, CleanBurn silica sand from Amazon did turn out to be the promised off-white color, with a consistent fine sand texture.

After looking at many sand samples from a lot of different sources, I finally settled on the sand sources I list in [9]. I also computed the cost per ounce. By comparison, commercial model railroad ballast sells for about 40-50 cents per ounce.

I have verified the color and granule size of these various sand products to make sure they're suitable for ballast using the methods I present in this article.

MAKE YOUR OWN BALLAST | 9

Product	Quantity	Color	Mesh	Price	Cost per oz	Source	Suggested scale
Firepit silica sand	10 lbs	light tan	20-40	\$33.00	\$0.21	Home Depot	O, S
CleanBurn silica sand	12 lbs	off-white	30-50	\$18.00	\$0.09	Amazon	HO, N
Santastic play sand	25 lbs	bright-white	40-50	\$19.00	\$0.05	Amazon	N, Z

9. Best commercial sources for sand that can be used to make ballast you can color as needed. See the shopping list link at the end of this article for specific links for purchasing.

COLORING THE BALLAST

Now comes the most fun part, coloring the ballast to the rock color we want!

I did a lot of research online and found a number of ways to color the sand. One method uses latex paint, but I don't like that method because it makes the sand granules larger and more rounded.

The other method I found online uses Rit dye to color the sand granules. After trying it, I find it's very effective [10, 11].



10. Here I show some examples of the ballast colors I've made using Rit dye. From left to right: original off-white sand, light sandstone, medium brown, light cool gray, and medium warm gray. The track in the background has the light gray ballast glued in place.



11. It's also possible to make the ballast quite dark starting with the off-white sand. In this case, I am aiming to make a very dark cinder ballast. From left to right: dark warm gray, fresh black cinder, and weathered cinder ballast.

Dye colors the sand nicely without obscuring the angular shape of the sand granules and it doesn't increase the granule size.

I buy the Rit liquid dye and make a concentrated ink using 70% isopropyl alcohol. With the dye colors shown [12, 13] plus some dry powdered pigments (more on that later), I can make all the ballast colors I show in this article and more.

You may be surprised that I'm using Navy blue as one of the dye colors. Actually, that allows me to make a cool gray tone. If I want to warm the gray tone up, I can use the Sandstone or the Cocoa brown dye with the gray pigments.

One important concept to keep in mind here: don't just do one batch of sand with a single color. The most realistic ballast comes from making a blend of several colors of similar shades.

For example, I make a basic medium cool gray, a medium neutral gray, and a medium warm gray batch. Then I blend them all together to get a very natural looking ballast. If I just use a single color batch, the sand tends to look less realistic and a bit "plastic."

Blending various similar tones looks much better. In some cases prototype ballast has a salt & pepper look – you can get that by blending much darker and much lighter batches together.





12, 13. To color the ballast I use Rit liquid dye. These colors shown here give me the color ranges I show in this article: Charcoal grey, Pearl grey, Navy blue, Sandstone, and Cocoa brown. I mix the dyes with 70% isopropyl alcohol to make a concentrated “ink” for coloring the sand.



★★★★★
RATE THIS ARTICLE



14. I mix these dye solutions in 30ml dropper bottles. For most I mix 50% dye to 50% isopropyl alcohol (IPA). For the Navy blue, I am using that more as a tint, so I mix it 25% dye to 75% IPA.

Making the dye solution

I mix the dye solution in 30ml dropper bottles I bought on Amazon (see end of article for shopping list).

For most of the dye solutions, I mix 50% dye and 50% isopropyl alcohol (IPA) and I shake the bottle thoroughly. With the Navy blue dye, I want to use that more as a cooling tint than to make blue ballast, so I mix that 25% dye and 75% IPA.

Before each use, I shake the dye bottle vigorously to make sure the dye is mixed well with the IPA.

Dying the sand

Let me describe the basic sand dying process, then I will give a couple actual examples so you can see the process of matching colors in action.

I put a half cup of the off-white sand [15] into a 1 gallon plastic ziplock bag. Then I dribble say 50 drops of the basic color I'm



15. I measure out about half a cup (4 oz) of sand in a Pyrex measuring cup. Note: I have my own measuring cup in my workspace so I don't risk getting residue from my modeling materials into our food!



16. I pour the sand into a 1 gallon zip lock freezer bag and then dribble at least 50 drops of dye solution at a time onto the sand. Then I seal the zip lock on the bag so nothing will spill out on the next step.



17. I knead and shake the sand in the bag until the dye gets thoroughly distributed into the sand. I repeat this process with more dye until I get the sand to the color I want. Then I spread the damp sand out onto a paper towel and let it air dry.



after, such as Charcoal grey [16] and then knead and shake the sand until the color covers all the sand.

If the sand hasn't reached my target color, then I repeat the process. I add more dye and do more kneading to darken the sand color still further until I reach my desired ballast color.

I do 40-50 drops of dye solution at a time, and I often end up using a total of 150-200 drops of dye to get my target color.

Once I am happy with the sand color, I pour the damp sand out onto a paper towel and let it dry overnight.

Making several similar colors: Real railroad ballast actually has subtle color variations and isn't all one uniform color. So to enhance the realism, I make several batches, varying the color formula slightly.

On one batch I might add 50 drops of Navy blue to make a cool grey and then on the next batch use 50 drops of Cocoa brown to make a warm gray.

After all the sand has dried, I blend the similar colors together to get a more realistic subtle variation to the granule color.

Let's look at a couple examples to see how I go about matching the ballast color.

Example 1: Siskiyou Line ballast

Because I model the Southern Pacific Siskiyou Line in southern Oregon, I wanted to match the ballast for my chosen prototype.

The first step when matching scenery elements on a given prototype is to collect reference photos [18, 19, 20].

I know of modelers who may take some ballast stones from their chosen prototype, for example, and try to match that. I've also seen modelers take paint chips from their prototype and try to match that on their models.





18, 19, 20. Work from prototype photos to create your ballast colors. Color balance can vary between photos, so use several like I'm doing here. My prototype Siskiyou Line ballast is a medium gray color with a bit of yellow or tan hues mixed in. Notice in the bottom right photo, the ballast looks a bit darker and a little more blue-gray. I'm aiming for a ballast color that's a good blend between all the shades of gray you see here – sort of the “happy medium.”

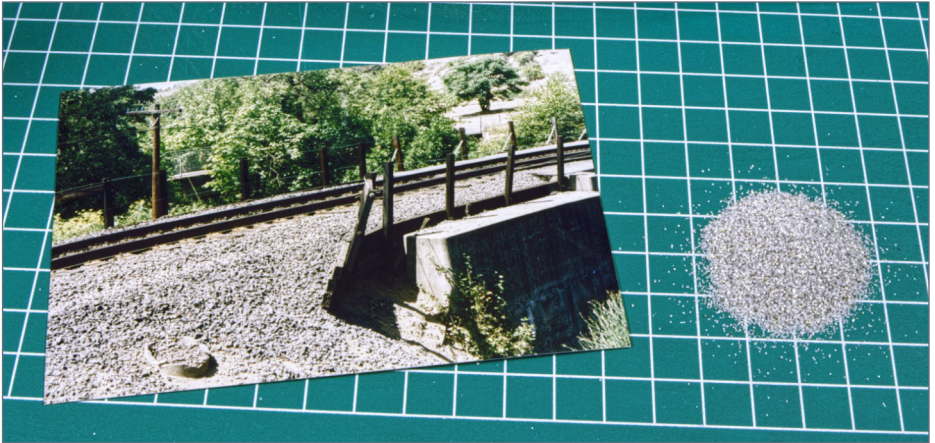

21. Using my reference photo, I matched the ballast color to how it appears in a sunlit photo. With commercial ballast, you can get into the ballpark as to color but it's an approximation only. With this method, I matched my prototype ballast color with pinpoint precision under my layout lighting. It doesn't get any better!

Such an approach doesn't work well because our indoor lighting tends to be a lot more yellow and less intense than outdoor lighting. As a result, anything we bring into the layout room will look a lot darker and more orange that it looks outside.

So how do we deal with the light color and intensity difference? We somehow need to make the color of what we're doing indoors look like it's outdoors.

The best way to solve this problem is to use reference photos that look good to us and are reasonably similar in white balance. Here's how it works.

If we take a photo that shows our reference prototype outside and we match the photo color when viewing the photo under our layout lighting, in effect, we're making that thing look like it's outdoors while under our layout lighting – which is exactly what we want!



If you want to match prototype coloring, that's how to do it – match good white-balanced photos of your prototype when viewed under your layout lighting [21].

I made several batches of ballast with each half-cup batch being slightly different colors. I put about 100 drops of Charcoal grey as my base color. Then I made the following variations:

Batch 2 variation: 100 drops Charcoal grey, then 100 drops Sandstone (tan-grey).

Batch 3 variation: 150 drops Charcoal grey, then 50 drops Navy blue (cool slightly darker grey).

Batch 4 variation: 150 drops Charcoal grey (slightly darker grey).

Once all the batches had dried, I mixed them all together to get the ballast you see in [21].

Example 2: “Weathered cinder” ballast

As an experiment, I wanted to see if I could make dark cinder ballast with this method. Since I'm starting with off-white sand, I wanted to see how dark I could get with the ballast color.



22. As a reference for a very dark cinder-like ballast, I chose the Denver & Rio Grande mainline as the prototype.

23. I also found this closeup reference photo of cinder stone ballast by doing an online search.



For my prototype, I selected the Denver & Rio Grande Western mainline, so I searched on Google to locate some photos [22]. I also searched online and found this closeup reference photo for cinder stone ballast [23].

As you can see in [11], I was able to make very dark cinder stone ballast. Here's how I did it.

Batch 1: To get a basic dark stone color, I used 400 drops of Charcoal grey dye.

Batch 2: I used the same dye formula as batch 1, but I also added 50 drops of Cocoa brown.

Batch 3: I used the same dye formula as batch 1, but I added 50 drops of Navy blue.

Note: I apply the drops 50 at a time, knead and mix in the color into the sand, then do another 50 drops, and so on.

Once all these batches were dry, I mixed them together to get the blend you see in [24].

To me, cinder ballast has a dark dusty look, so I added 1 teaspoon of dry black powder pigment to a half cup of my blended

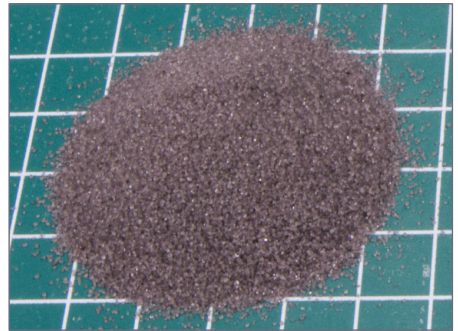

24. My dark warm grey ballast blend. See text for details.

dark ballast in a plastic jar, then shook vigorously to get this quite jet black ballast [25]. Then I mixed equal parts of the dark grey blend with the jet black mix to get the dark weathered cinders in [26]. I could make it even lighter by mixing in more dark grey blend.



25. My fresh black cinder mix. See text for details.

Notice you can also mix in a dab of the dry powdered pigments I've discussed in my zip texturing articles to tweak the tone and look of the ballast to some degree. See the Sep/Oct 2010 issue and the Nov/Dec 2010 issue of MRH magazine for more:

- mrhmag.com/magazine/mrh-2010-SepOct/zip_texturing_resurrected
- mrhmag.com/magazine/mrh-2010-NovDec/weathering_powers

Concluding thoughts

I'm quite pleased with the results of my experiments in making and coloring my own stone ballast. Using these methods, it's possible to get ballast for most any scale in the right texture and color from O scale to Z scale. ✓

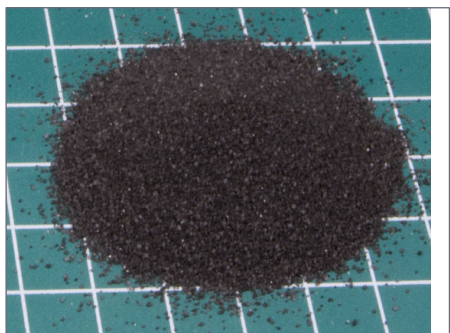

26. My weathered black cinder blend. See text for details.

SHOPPING LIST

To get a shopping list for the items mentioned in this article, visit this link:

<http://mrhmag.com/magazine/mrh2020-12/make-own-ballast>



RATE THIS ARTICLE



It's all about trains

*All things train related,
whenever, wherever.*

**TRY
24TRAINS.TV
2 WEEKS
FOR FREE**



WWW.24TRAINS.TV

On 24TRAINS.TV you can find:

videos | travel reports | magazines | vlogs

model railways | workshops | documentaires | holidays



REGISTER
(free)

[INDEX](#)

[TABLE OF CONTENTS](#)

Ops for the rest of us

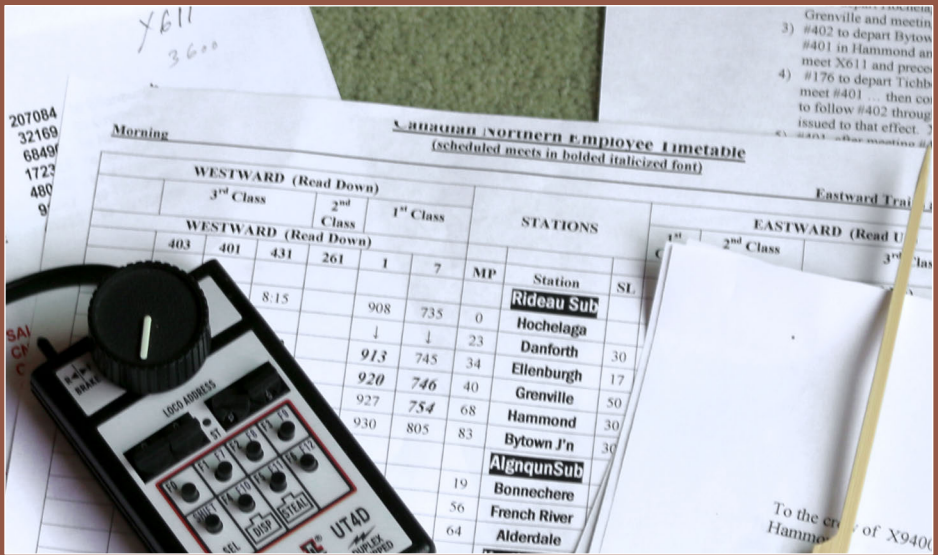

Model Railroad Hobbyist | December 2020



DOUG MATHESON DIPS HIS TOE INTO PROTOTYPE OPERATION ...

MRH RAN A SURVEY IN 2018 WHICH REVEALED ABOUT 75% of their readers enjoyed operations on their model railroads. Some 50% of all MRH readers expressed the desire for a straightforward approach, with little to no paperwork. MRH calls this reader preference “lightweight ops” or “operations light.”

WHAT IS OPERATIONS LIGHT?

The idea of running trains instead of doing paperwork sounds appealing. However, it's basically just the opposite of "operations heavy" or heavyweight ops. Heavyweight ops describes a world filled with TT/TO rule books, employee timetables, complex car routing schemes, and arcane dispatching mechanisms.

Heavyweight ops has its basis in the prototype practices developed over the years for the safe and expeditious movement of rail traffic. Railroading without rules is a dangerous business, and these rules made running trains a lot safer and more efficient.

But getting to lightweight ops requires a *vast simplification* of what the real railroads did.

In this series, I present a foundation for a simple and relatively paperless approach to enjoying operations. At the same time, I

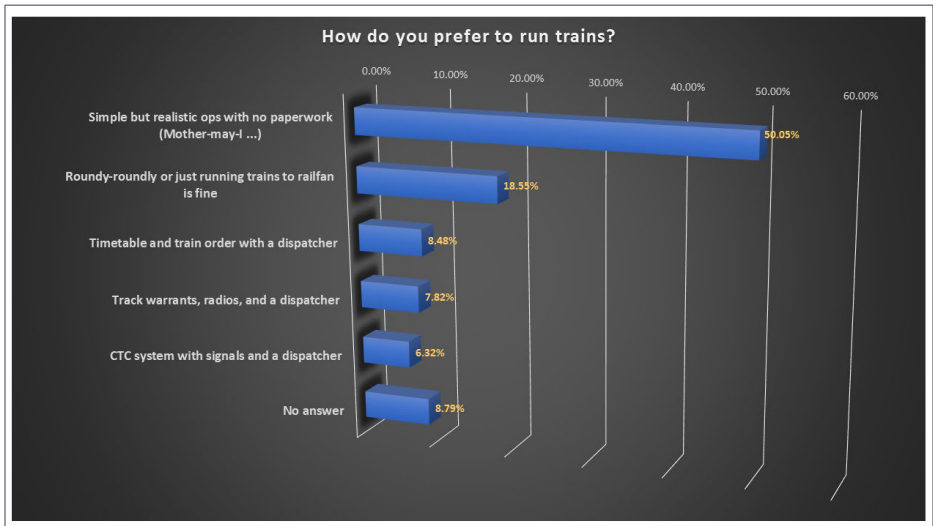

1. The MRH survey of 2018 show most readers want a simple paperless approach to operations.



provide a path forward for those who may want to evolve toward a more realistic “heavyweight ops” environment from simple beginnings.

A WORKING DEFINITION OF OPERATIONS LIGHT

The *MRH* survey defined heavyweight ops as the existence of a formal dispatching mechanism to identify what was light and what was not. While this works for a brief survey, I believe the

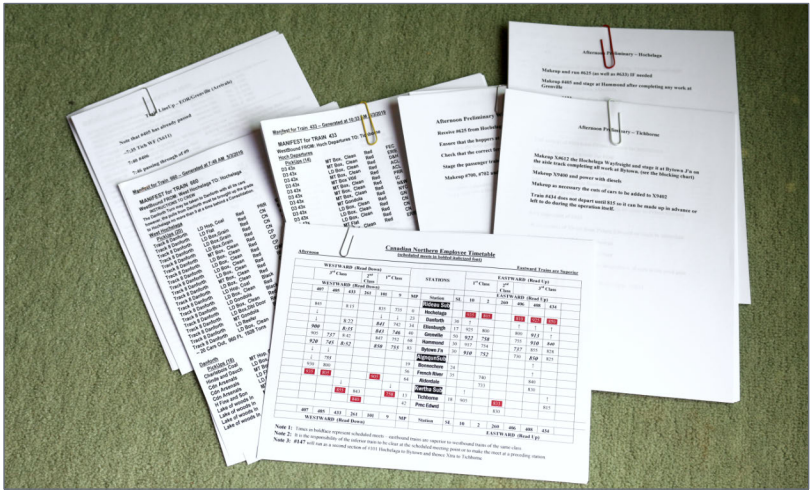

2. Tom Hood’s Canadian Northern is an example of heavy-weight ops. Each operating session requires generating more than 150 fresh pages to guide operators. This includes the timetable plus switchlists for each operator on the mainline. Yard crews require switchlists and lineups to guide their work. And in addition, Tom has trains staged on the layout for startup, which also need train orders for the layout’s Timetable/Train Order environment. Additional documentation includes a set of instructions for the crews who stage the layout the week before an operation. All this paperwork and any paperwork created during the ops session (such as train orders and the dispatcher’s trainsheet) are exactly what operations light is trying to avoid.

best approach to operations light involves more than simply saying no formal dispatching mechanism has been implemented.

I see operations light vs. heavyweight ops as a continuum:

1. Complexity of the layout: Size by itself does not define light or heavy operations, but does influence it – as layouts become larger, the complexity grows and the ops become heavier.

2. Numbers of trains operating simultaneously: Not the actual number so much as the degree of interaction between trains matters here. Of course, the more trains running, the greater the potential number of interactions. This ties back to the dispatching mechanism focus of the *MRH* Survey.

3. Car-forwarding: How you define the movement of cars influences the level of paperwork. Simple schemes with minimal paper fit the operations light approach while complex implementations of car cards or computer generated switch-lists sit at the other end. In-between sit a large number of approaches involving simplifications of the complex parts.

4. People and the relationship to prototype fidelity: Larger crew sizes drive more operation complexity. This complexity increases if the layout owner wants crews to perform their roles more the way prototype crews carried out their duties.

GENERAL APPROACH

Given a working definition of operations light, let's discuss operations in general here in Part 1. Later in this series, I delve into these further topics:

Part 2: Two example model railroads that qualify as running with operations light.

Part 3: Developing a model railroad transportation plan: What trains move when and/or in what sequence.



Part 4: Car-forwarding options, from paperless to limited paper.

Part 5: An evolutionary path to more complex operations.

OPERATIONS – WHAT IS IT?

Pioneers in operations (1940s through to ca. 1980): Model railroad operation has often been described as “a simulation of the purposeful movement of goods/people by rail.” A simulation carried out live, as opposed to on a computer, is essentially a role-play as a cooperative non-competitive game.

In the pioneering days of model railroading in the 1940s, Frank Ellison defined operations as a stage play where the trains are the actors.

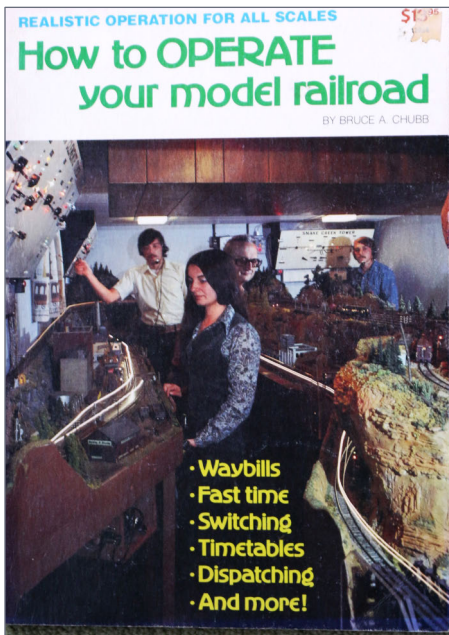

3. Bruce Chubb wrote the definitive work on model railroad operations almost 50 years ago. Although it is somewhat dated from a technological viewpoint, the great majority of Chubb’s thoughts remain as relevant today as when first written. Many others made valuable contributions to the development of operations in the hobby during the 60s and 70s – John Allen and Allen McLelland come immediately to mind – but none left the written legacy that Bruce Chubb did. Chubb made other innovations to the hobby including

developing CMRI as a standard interface between a computer and a railroad. He remains active in the hobby and his model railroad, the Sunset Valley Oregon System, continues to stand among the best-known for the operations sessions hosted.

Bruce Chubb made this concept central to his writings on operations. In his 1977 book, *How to Operate Your Model Railroad*, on p 37, Chubb wrote, “A railroad without trains would be like a movie without actors.”

In an era of cab control, both Ellison and Chubb seem to be right. The trains perform as the actors in a play set on the stage of the model railroad – with the operators controlling them from afar using cab control almost like puppets on a string. The march of technology gave us command control in the 1980s, and by 2000, DCC became the dominant control method.

Layout design evolved to keep step with control changes and now operators move *along with* their trains using handheld throttles. This slow crawl of technology has led to new ways of thinking about the simulation of the operation of a railroad that our model empires represent.

Operations thinking evolves (from 1980 to the present): Think about the effort we put into building a piece of equipment or a structure. We try to make it as accurate as possible as a static object. But since our models can actually move, we incorporate them into a grand animated diorama: the model of a transportation system.

Further, as we bring this animated diorama come to life, we model the jobs of those who worked in the real world. Essentially, the notion of the trains being the actors in an elaborate play has given way to the idea that *we the operators are the actors in a role-play* or simulation of a transportation system.

Tony Koester articulated this notion of role-playing in his 2003 book, *Realistic Model Railroad Operation*. He wrote at length about this, prefacing it with the remark (on p. 9), “We’ve discovered that what railroaders did or do for a living is often as fascinating to emulate as the train movements themselves.”

The 2017 OpSig publication, *A Compendium of Model Railroad Operations*, builds further on the role-playing idea. In chapter 3, Jim Providenza extended the cast of role-players to include many new



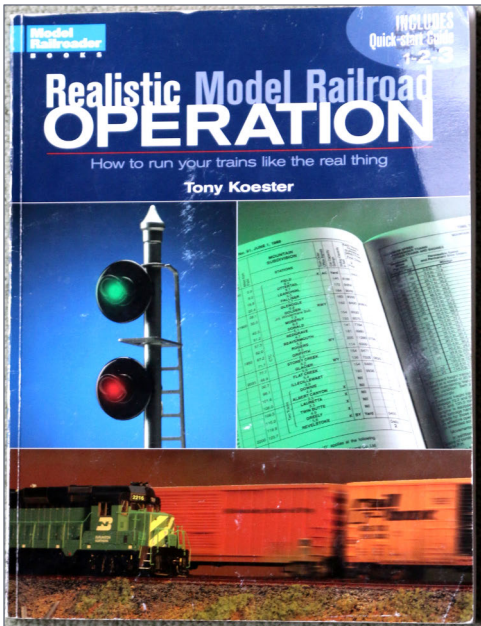

4. Tony Koester was among the first to elaborate on the notion of role-playing railroad employees, a notion he set forth in his book. Tony takes a more philosophic approach in his book, being less prescriptive than the earlier work by Bruce Chubb. Nonetheless, Tony's book represents another step in the evolution of model railroad operations.

possible characters from the direct operation of a real train. He agreed with Tony Koester, writing, "We work hard and long on our layouts to create the conditions that allow those operating on them to experience the challenges and rewards of professional railroading."

THAT SOUNDS COMPLEX!

The concept of model railroad operation as a role-play can be as complex as you want. The simulation can be at a high level with a focus on the operation of a single train through your modeled scene.

Complexity gets side-stepped to allow a lone operator to act as an engineer in an idyllic environment.

Or the layout, ops simulation can become so detailed that a modeler can calculate if the railroad is turning a profit, modeling all manner of jobs from train engineer to senior management.

The point of this is simple: you create the role-play you want and you decide its complexity.

You decide which jobs to model and you decide how detailed to make the role-playing for your actors.

Almost universally, model railroaders want their hands on the throttle – we like to run our trains! In that sense, the engineer’s job invariably becomes a primary role of our simulation. For some modelers, just handling a heavy train on a steep grade can keep them happy, and we have to admit, you do need a certain skill to handle such a train.

Many modelers seem to prefer a more complex simulation for their ops role-playing. But as the guys involved with heavyweight ops confess, jobs unrelated to the movement of a train rarely are the model railroad operator’s first choice.

Those unrelated jobs tend to be clerical in nature. While the real railroad *requires* station agent/operators, yard clerks, and similar positions to keep the railroad running smoothly, most of us (as evidenced in the *MRH* survey) prefer our simulations to be high level enough to avoid most of the clerical side.

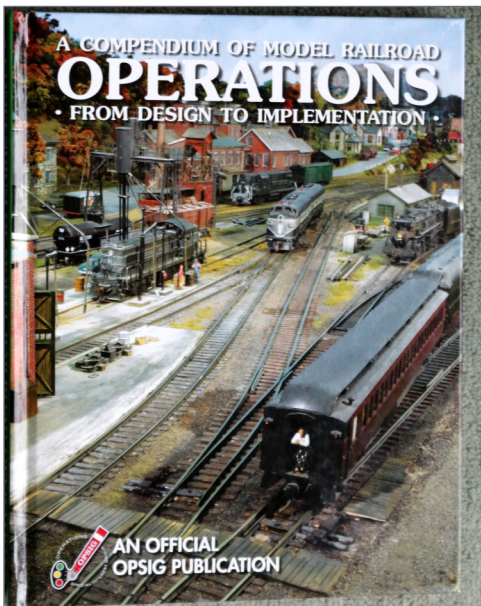

5. Editor Phil Monat pulled together a group of experienced operators to each write a chapter in this book. It represents, in 2017, a collection of current thinking about model railroad operations. It is not an easy read for a beginner, but for someone with some experience, it provides a valuable reference to all ops-related topics.



REGISTER
(free)

[INDEX](#)

[TABLE OF CONTENTS](#)

RAILROADING AS YOU LIKE IT

Obviously, most operators welcome the positions of engineer and conductor, and as such they form the central part of the role-play in an operations light environment. A *footboard yardmaster* – that is, a yardmaster who runs his own switcher – would also be a desirable role to portray.

From there, the roles become increasingly specialized. Ranked in order of popularity, dispatcher seem to come first, after which the roles such as a yard clerk or station agent become less desirable. Depending on your motivation, the size of your railroad, and the numbers of crew you want, you must decide how detailed you want the role-play to be. You decide which jobs to staff, and which real railroad functions can be ignored.

WHERE DO YOU BEGIN?

Playing baseball won't be enjoyable until a player learns to catch and throw the ball. Similarly, hockey cannot be played until a player learns to skate. In the same vein, role-playing model railroad operations won't be very enjoyable until a modeler masters a few basic skills.

Looking at the “purposeful movement of goods/people by rail,” a train does this by picking up goods or people and delivering them to another place. Our constraints of time, money, space, and skill mean we model part of this train movement and use staging or other means to suggest the unmodeled remainder.

The train originates somewhere, moves to “an action point or points,” performs some actions, and then departs. These actions are executed over and over by engineers and conductors operating a train:

1. Meeting or passing another train
2. Picking up or setting out one or more cars on a trailing-point spur
3. Making a runaround move

4. Picking up or setting out one or more cars on a facing-point spur

Experienced operators know these tasks by heart. A beginner to operations should study these simple moves – a tutorial called *Model Railroading 101* at slideplayer.com/slide/4536724.

Another resource with switching tips can be seen at www.youtube.com/watch?v=20U9c2_t6o4.

WHAT HEAVYWEIGHT OPS LOOKS LIKE

The following pictures briefly show what a heavyweight ops session looks like [6,7].

For many of us, handling all this paper may not be a pleasant experience – we don't relish being loaded down with all this stuff when we just want to just have fun operating trains.

Expectations can run high for operators such as Pierre to play their role with fidelity to prototype practice. Such an expectation can put operators into a high pressure environment that's quite uncomfortable.

Operations light is aimed at preserving the enjoyment of operations and avoiding most of the heavyweight ops pressures.

RIVET-COUNTERS IN OPERATIONS TOO

Rivet-counters inhabit more than just the world of model building. They exist in the operations world too – they're critical of everything from the simulation details to how "professional" the actors may play their role.

Just as in the model building side of the hobby, some good-natured rivet-counting raises our awareness of accuracy and can be helpful. But harsh and legalistic rivet-counting comes across as pompous and misguided – it effectively discourages modelers from taking part in what can otherwise be a very enjoyable part of the hobby.



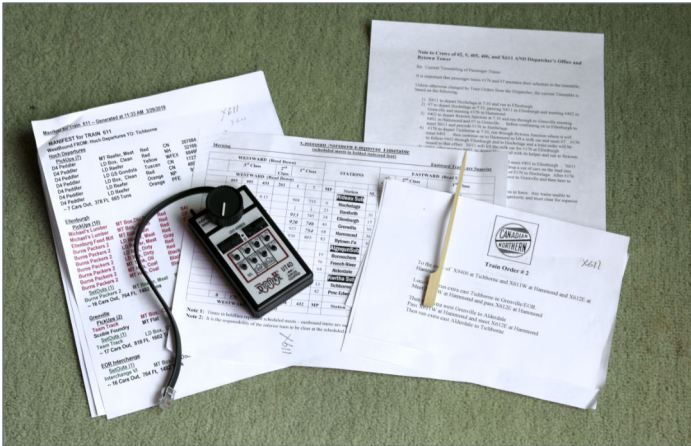

6, 7. Operator Pierre Lamontagne is well-dressed for his role, wearing an apron with multiple pockets. He is expected to carry (clockwise from left) his switchlist, the timetable, special instructions, train orders, an uncoupling pick, and most importantly, his handheld throttle.

Consider the frequently leveled criticism by the experienced heavyweight ops guys that “Ted over there on X3410 failed to do xyz correctly.” The rivet-counter then spells out how *they* think a real railroad employee on a certain railroad in a certain era would have done xyz.

As our hypothetical lone operator with train X3410, we expect Ted to play a variety of roles.

First, we expect him to act as the engineer and drive that train, operating his loco just as the real engineer would have.

Next, we expect him to be the conductor, keeping in mind all the car setouts and pick ups to be made – all while keeping in mind the schedule for all other trains on his part of the railroad.

At the same time, we expect Ted to act as the head end and tail end brakeman, aligning switches and handling the couplers.

Ted has to carry his throttle, his car cards or switchlist, an employee timetable, and any train orders or track warrants, an uncoupling pick, a pencil, sometimes an FRS radio – and if he is lucky and has a free hand, his drink.

The fast clock keeps whirling while Ted works in a crowded, noisy, narrow aisle, typical of most layouts.

So what horrifying error did Ted make? Ted forgot to dim his headlight while making a meet!

Belittling Ted about his “oversight” won’t leave him in a good frame of mind. In fact, Ted may decide participating in a realistic model railroad op session just isn’t worth it!

There is no place in operations light for such rivet-counters. They need to realize being so harsh is not helpful. If they can’t adjust their approach, it may be best to not invite them to op sessions.

When you organize your ops sessions, be specific. Define your role-play character activities based on the importance you put on your ops simulation outcome. It can help to not be too idealistic.



LOOKING FORWARD TO THE NEXT PART ...

Despite the challenges we face around getting realistic operation, take hope. Effective methods do exist to simplify ops processes and guide us in developing a lighter-weight ops plan. Exploring lightweight ops methods is something we all can be thinking about.

Stay tuned for Part 2. I want to show you two well-conceived model railroads and the operations light approach they take. We will be visiting Bruce Chandler's Fn3 and Mike Hamer's HO layout – and take a close look at their inspiring simplified approach to operations.



RATE THIS ARTICLE



8. Bruce Chandler built the Jackson and Burke, an Fn3 railroad in his back garden. *Photo courtesy of Bruce Chandler*



9. Mike Hamer models Boston and Maine on a modest HO layout.



Did you see this article?



Prepping cars for layout operation

Get the December eBook now

← *click here*

In



RUNNING
EXTRA



REGISTER
(free)

[INDEX](#)

[TABLE OF CONTENTS](#)

DOUG MATHESON



Doug authored a chapter in the OpSIG (Operations Special Interest Group) publication, *A Compendium of Model Railroad Operations*.

Doug has been participating in ops sessions for decades. He has also presented NMRA clinics on ops, organized ops sessions for a number of owners of large model railroads, and served on a model railroad as a dispatcher using Timetable and Train Orders, and on another layout using the Occupancy Control System (Canada's version of Track Warrants). These all fit into the more heavyweight category of prototype-based operations.

At the same time, Doug has built and operates a very modest HO scale layout. He has also long modeled in Fn3 in the garden, including running live steam.

Doug thanks Bruce Chandler for his help in allowing his Jackson and Burke RR to be used as an example and inspiration for this article. N scale modeler Mike Dawson provided insightful comments on operations in a scale where reporting marks are difficult to read. A big thanks also to a number of Doug's fellow members of the NMRA (Niagara Frontier – St Lawrence Division) who offered many suggestions and edits along the way. These include Alex Binkley, Mike Hamer, Chris Lyon, and Peter Nesbitt. In particular, Mike Hamer also allowed his Boston and Maine RR to serve as an example.

Besides operations, Doug's other railroading interests include the history of passenger travel by rail, and the historical development of signaling systems.

Doug retired from Canada's federal public service and lives in a rural area south of Ottawa, Ontario. ■

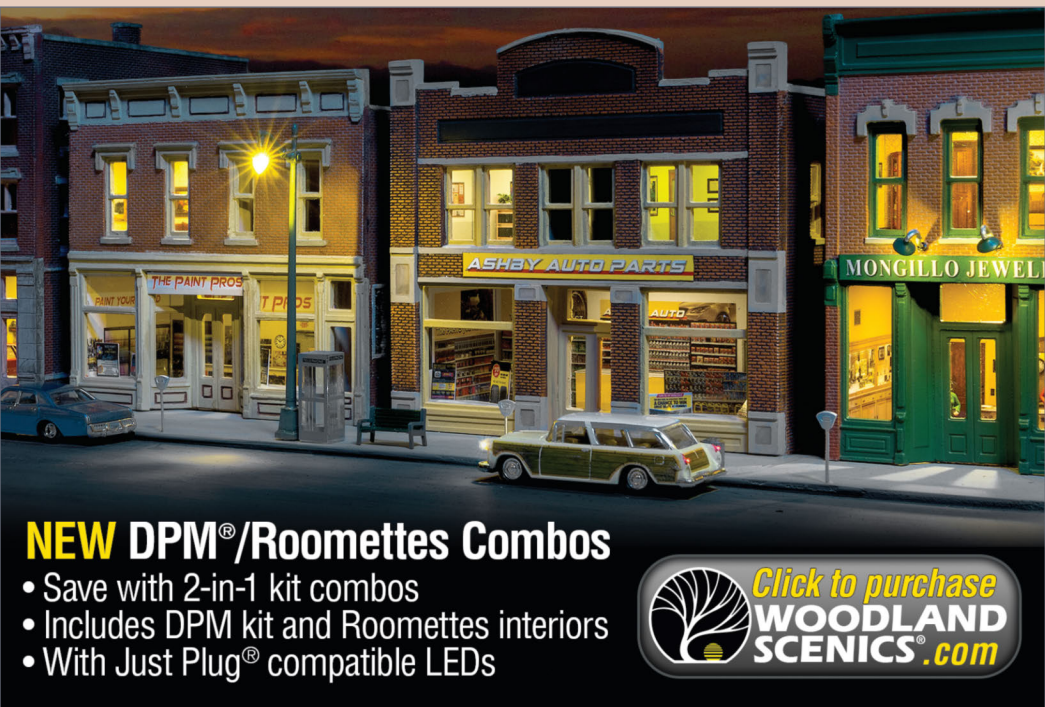

NEW DPM®/Roomettes Combos

- Save with 2-in-1 kit combos
- Includes DPM kit and Roomettes interiors
- With Just Plug® compatible LEDs



Click to purchase
**WOODLAND
SCENICS®.com**

Use our custom
Google search on the
MRH website to find
topics of interest

CLICK TO FIND OUT MORE



REGISTER
(free)

[INDEX](#)

[TABLE OF CONTENTS](#)

BNSF - WICHITA, KANSAS



Model Railroad Hobbyist | December 2020



DEREK DUNCAN FITS THIS
CONTEMPORARY LAYOUT INTO A 24'x24'
SPACE ...

I WAS IN THE PROCESS OF DESIGNING A 14" X 12' MODULAR SHELF layout to incorporate the Bel Aire Buzzi Unicem cement distribution facility, when *MRH* presented the "California Basement" Challenge. I chose the 2-Car garage version so that I could incorporate the Buzzi Unicem module into the layout, and thus the 24' x 24' constraint. To make my

BNSF - WICHITA, KANSAS | 2

railroad viable, I needed a reason for Buzzi Unicem to exist on my layout, so I took the real reason the facility exists in Bel Aire, Kansas. Buzzi Unicem supplies cement to multiple concrete mixing plants in the Wichita and surrounding communities. Wichita is the largest city in Kansas (most of Kansas City is in Missouri), and there is a lot of construction going on all the time. I chose one of these cement mixing

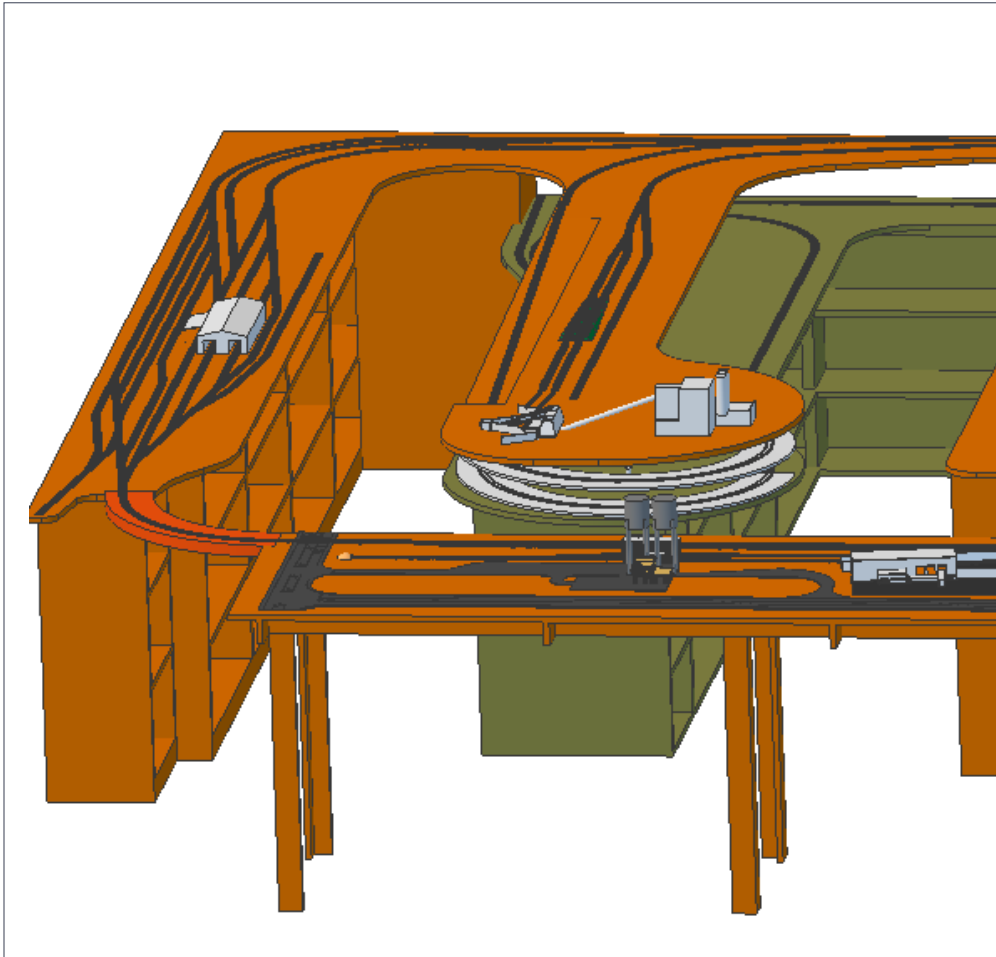

1. Side view.



REGISTER
(free)

[INDEX](#)

[TABLE OF CONTENTS](#)

BNSF - WICHITA, KANSAS | 3

plants (Andale Ready-Mix) to make Buzzi Unicem a useful industry on my layout.

Just having these two industries wasn't enough reason for this railroad. Having lived in Wichita for 30+ years, I started to think of what other industries would make interesting activities to ship-by-rail-to, and ship-by-rail-from. Another Industry in "The Air Capital of the World" is Spirit Aero Systems that makes 737

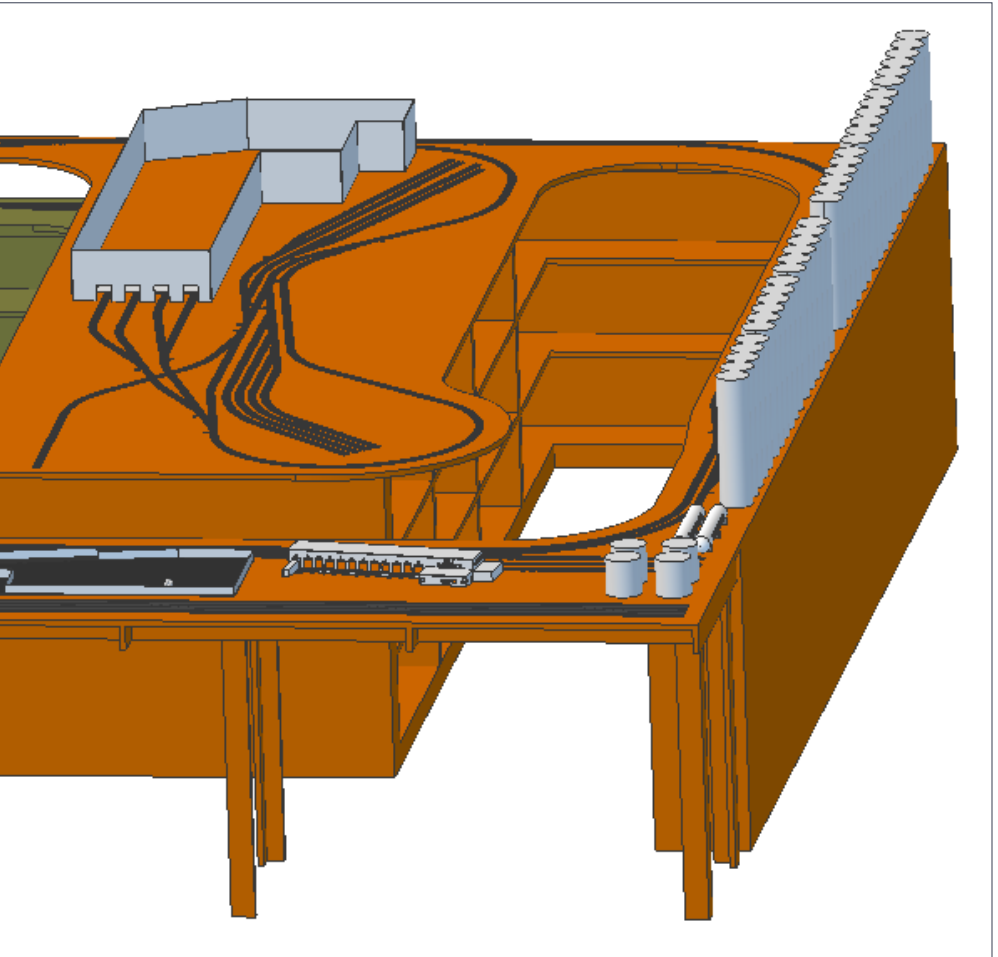



RATE THIS ARTICLE

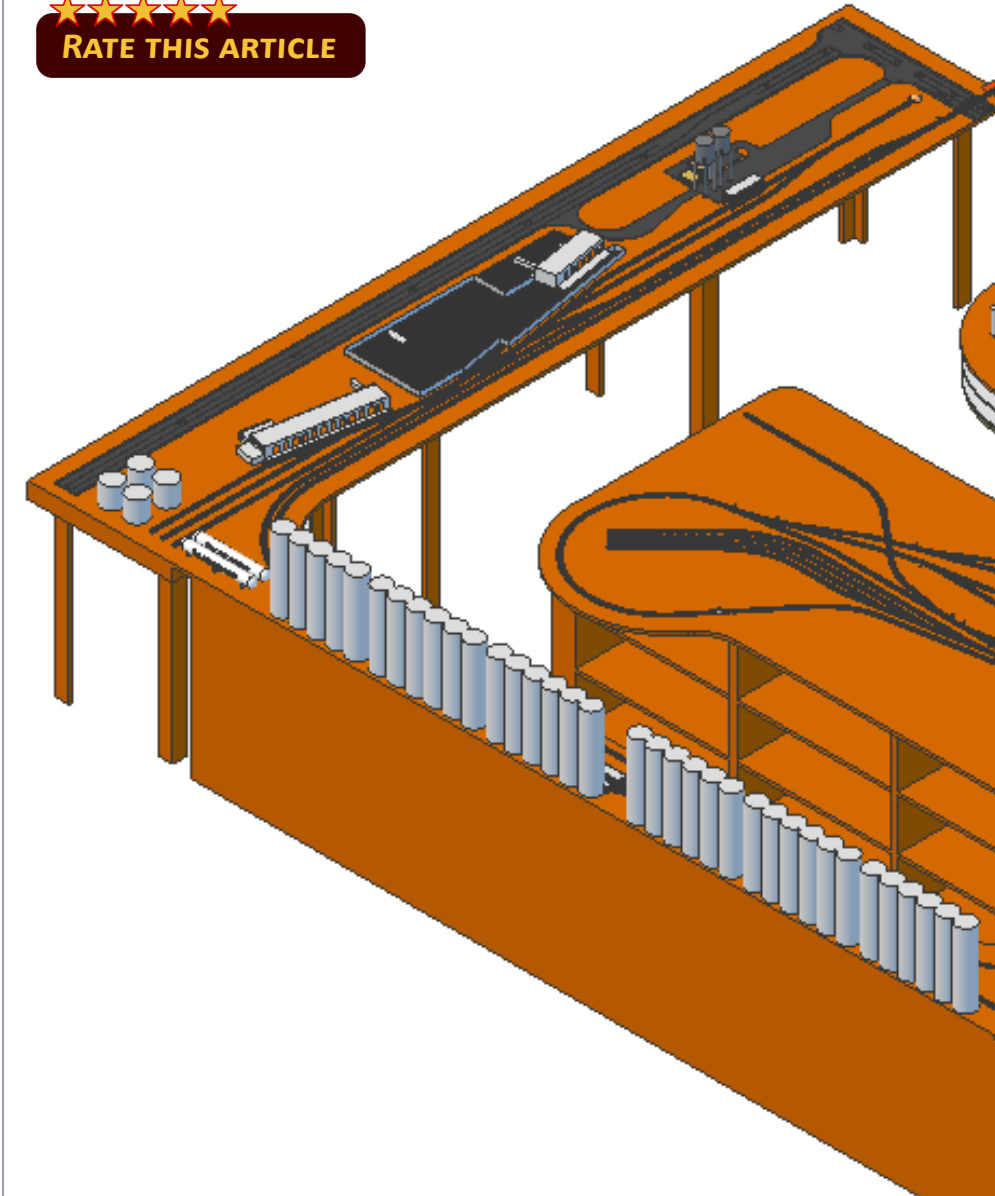

2. Top view.



REGISTER
(free)

[INDEX](#)

[TABLE OF CONTENTS](#)

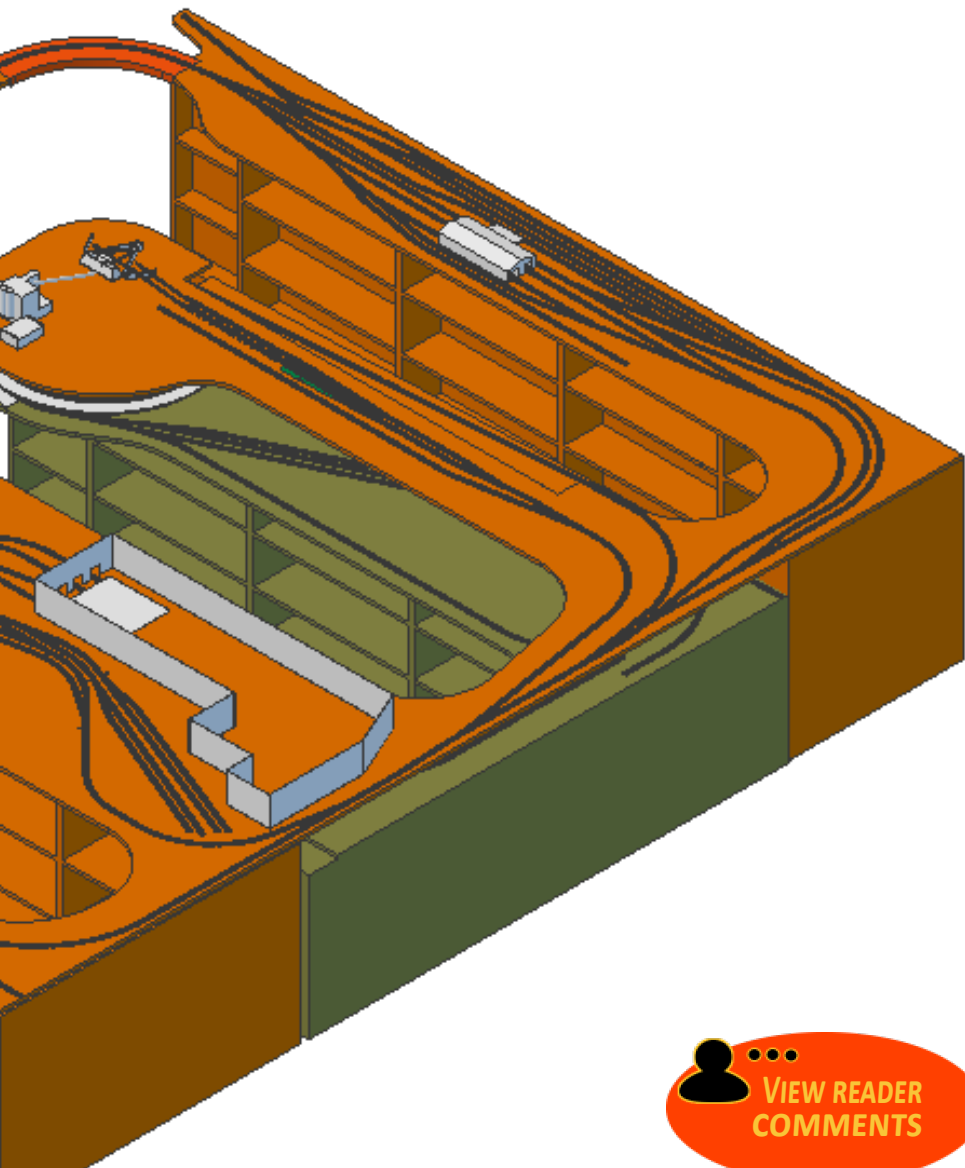

fuselages for Boeing and ships them by dedicated rail cars to Renton, Washington. I knew that I would not be able to model even a compressed version of that trip, so I chose to make Renton sort of “off layout.” Stay tuned for how I accomplish that.

Wichita is a major terminal point for wheat shipment via covered hoppers. A facility which used to be Garvey Grain (now DeBruce Grain, Inc.) is located Southwest of Wichita and is a massive complex.

Wichita also currently has two yards, the UP yard along I-135, and the BNSF yard along North Broadway (US highway 81). I chose to simplify and modify the UP yard.

This 24' x 24' track plan represents industries around Wichita, Kansas. I have not tried to faithfully model the Wichita area, but have taken artistic license to incorporate five area prototype industries into the track plan. Refer to [5] for the prototype locations:

- Union Pacific yard (red circle)
- Buzzi Unicem USA cement bulk transfer station (orange oval)
- Andale Ready Mix concrete batch plant (blue oval)

LAYOUT SPECIFICATIONS

Track plan Dimensions: 24' x 24'

Scale: HO

Prototype Railroad: BNSF

Era: Present

Minimum Mainline Radius: 30"

Minimum Yard Radius: 22"

Maximum Mainline Grade: 0%

Maximum Grade: 3.0%



- Spirit AeroSystems (aqua rectangle)
- DeBruce grain elevator (brown oval).

I've also included four other freelanced industries in the Bel Aire Industrial Complex.

TRACK PLAN OVERVIEW

The track plan has two levels, but the main trackage is all on one level without any elevation change [3]. I designed an “empties-in, loads-out” arrangement for the Spirit Aero Systems Plant 2 building.

To accomplish this, I incorporated a lower section representing Renton, Washington (without any structures or scenery [4]) 10 inches below the main line track elevation via a 3% grade and 1.5-turn helix. 737 airplane fuselages ship as open loads on the flat cars, so I needed some way to “unload” the fuselages.

To keep from using the unprototypical method of hand-lifting cars around the layout, I designed this track plan to keep all cars on the track. I then added switching operations to switch the loads out of the train and put empties in for the trip from Renton to Wichita by using the lower level.

Then on-layout switching operations at Wichita build a train of fuselages out, and push empties back into Plant 2 building.

FURTHER TRACK PLAN DETAILS

Wichita has both a Union Pacific Yard and a BNSF Yard within city limits. I model the BNSF, but some of the industries I include are served by the Union Pacific here in Wichita. I made this entire track plan BNSF-served trackage, although an occasional UP engine might show up.

I based the yard loosely on the Wichita Union Pacific Yard (red circle in [5]) and the entirety of [6].

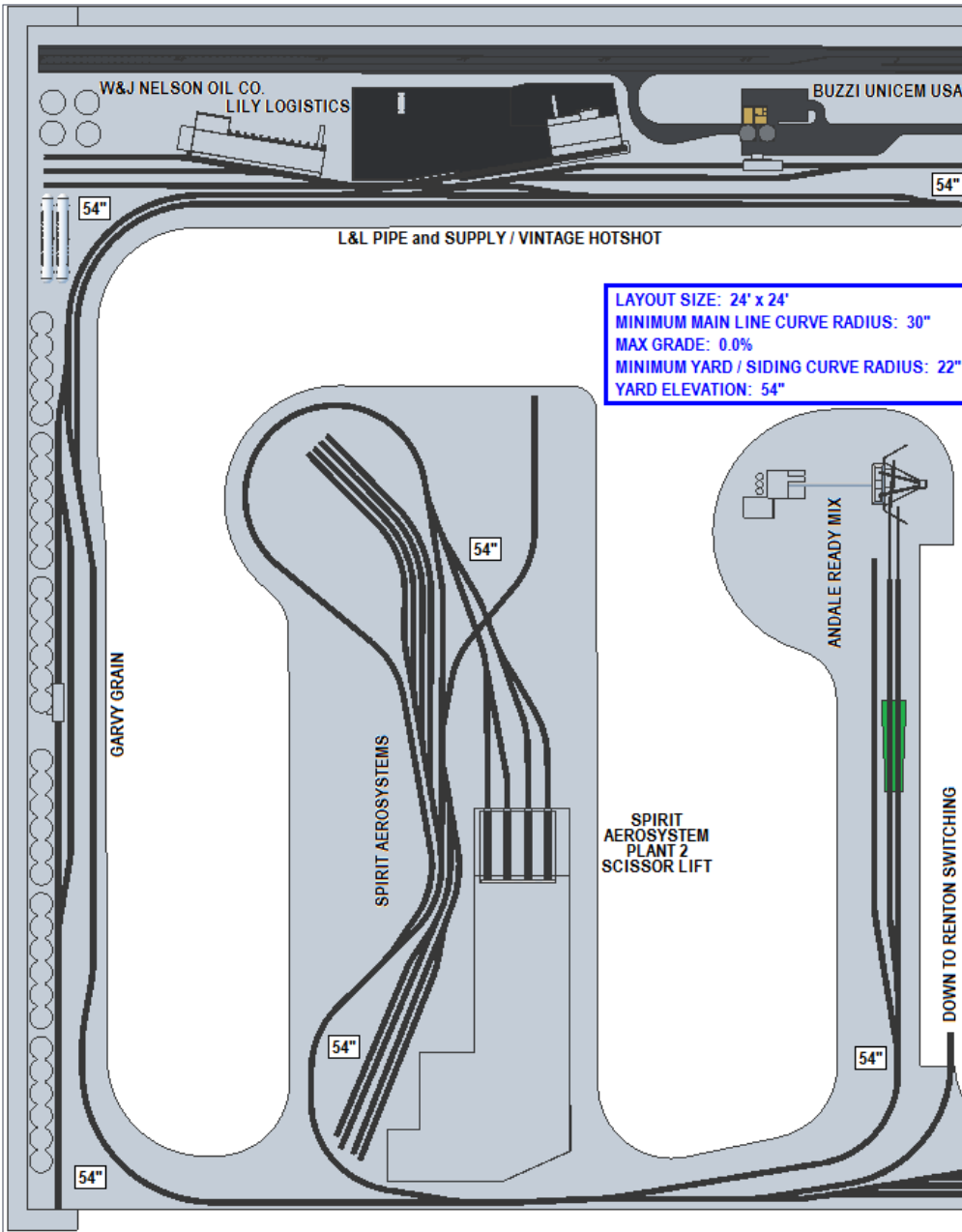

3. Main level of trackplan (Wichita, Kansas).



REGISTER
(free)

[INDEX](#)

[TABLE OF CONTENTS](#)

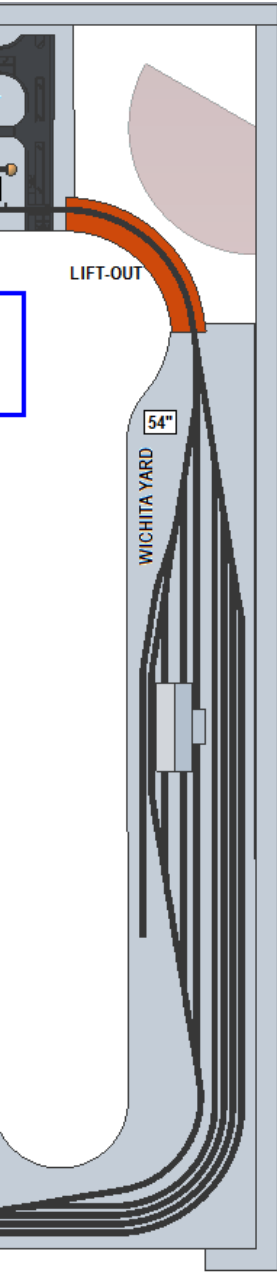

The prototype BNSF yard runs parallel to North Broadway (green oval in [5]) but does not have any shop facility. The BNSF yard does not connect directly to the Buzzi Unicem USA cement bulk transfer station in the Bel Aire Industrial Complex (orange oval in [5]).

On the prototype, moving cars from the BNSF yard to industries served by the UP would be through the Wichita Terminal Association (WTA), a jointly owned entity by the BNSF and Union Pacific railroads (lavender box in [5]). Trackage and motive power would be supplied per the agreed-upon arrangement, refer to wtarr.com.

The main level of the track plan has an around-the-room main line. The Spirit AeroSystems point-to-point transfer from Wichita to Renton uses a reverse-loop-to-reverse-loop arrangement, with switching at each end.



Did you see this article?



Prepping cars for layout operation

Get the December eBook now ← click here

In **MRH** **RUNNING** **EXTRA**

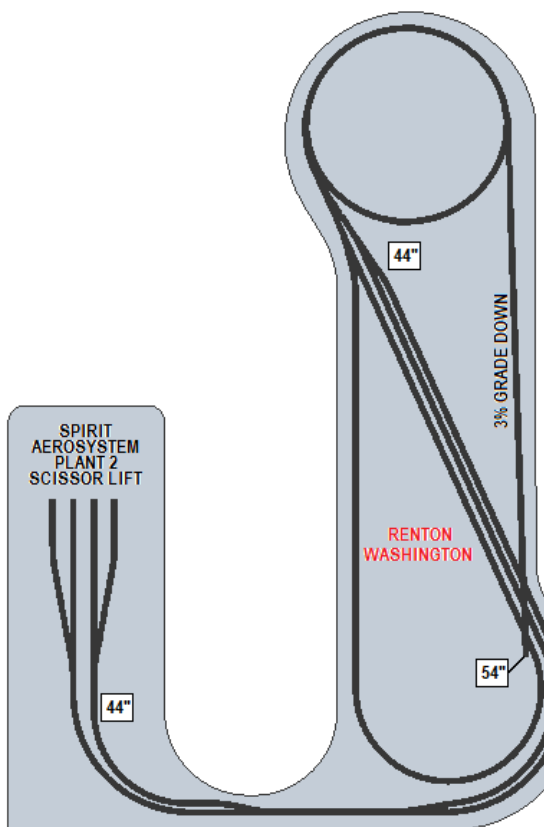

4. Lower level (Renton, Washington).



REGISTER
(free)

[INDEX](#)

[TABLE OF CONTENTS](#)

CONSTRUCTION THOUGHTS

I envision the layout would be constructed as sections/modules using 2" foam – possibly several layers of 2" foam bonded together – placed on top of storage shelves.

The Bel Aire industrial complex section is approximately 48" wide, so that section would be built with table-type benchwork, and the area beneath used to store large items, possibly with shelving and/or containers on wheels.

The Andale Ready-Mix and Spirit AeroSystems peninsulas would be constructed using benchwork on top of double-sided storage shelves. The trackwork along the garage door (bottom area in [3] and [4]) would be the same method, 2" foam on top of storage shelves. No part of the layout would be attached to the garage door.

All the foam and storage shelves are clear of the person door (represented by the arc in the upper right corner of [3] and [4]).

All the storage shelves could use a wood bookcase type construction. Another option would be to use pre-constructed cabinetry. (Salvaged from a kitchen remodel, perhaps?)

However wood L-girder type benchwork with joists and risers would also be a viable approach.

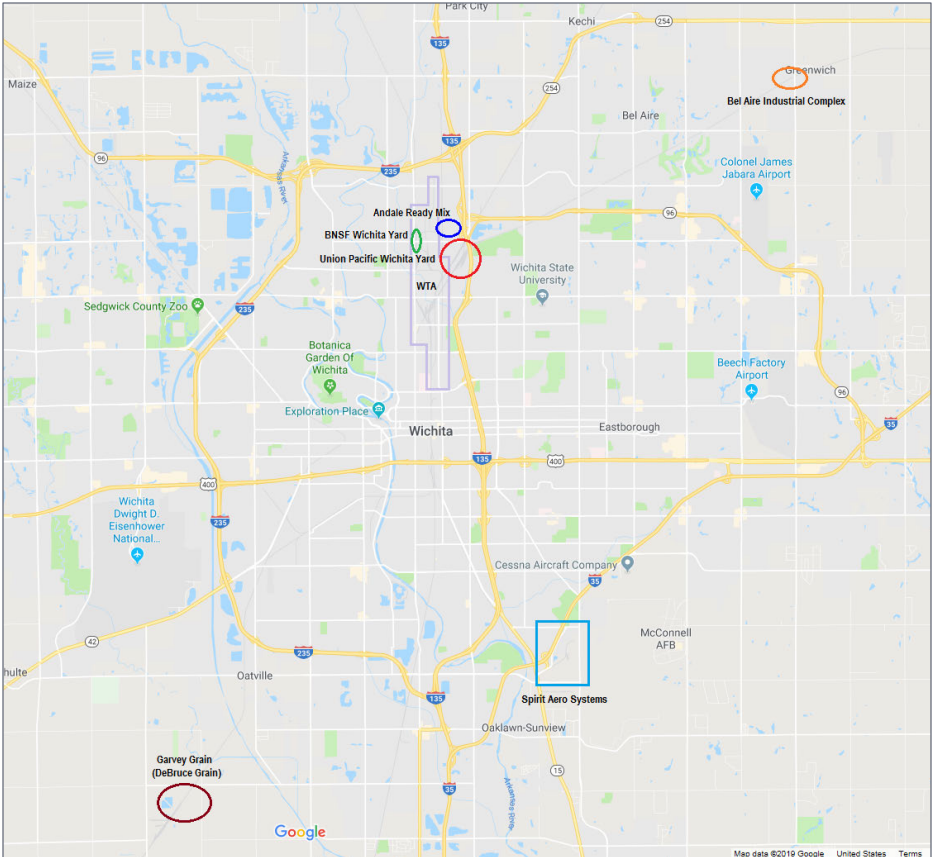

5. Wichita, Kansas map.

Did you see this article?



Layout design using LDEs
(layout design elements)

Get the December eBook now [← click here](#)

In **MRH** **RUNNING**
EXTRA



 REGISTER
(free)

[INDEX](#)

[TABLE OF CONTENTS](#)

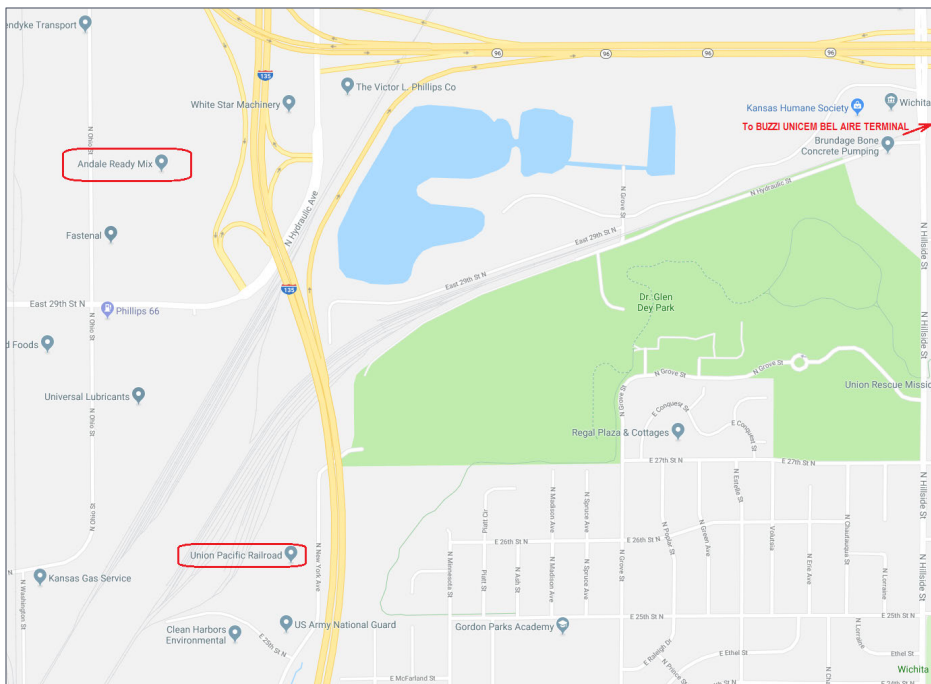

6. Union Pacific yard in northeast Wichita.



7. Satellite view of the Union Pacific yard, Wichita, Kansas.

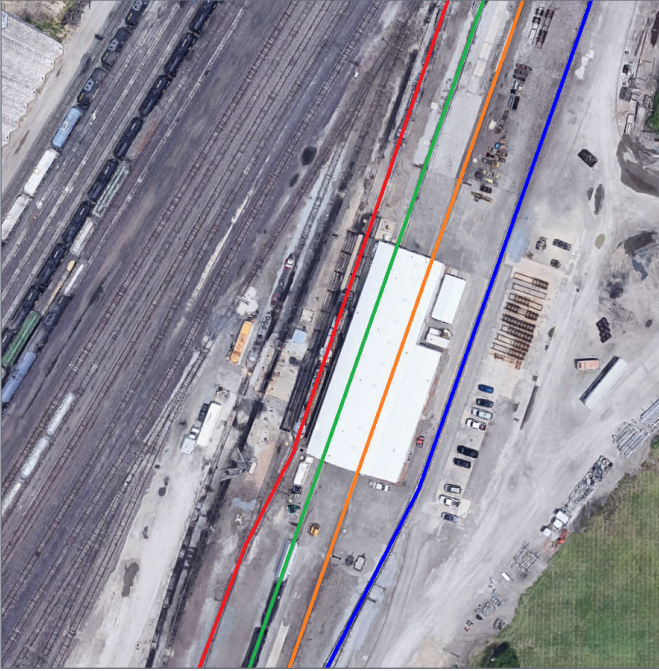

8. Wichita's Union Pacific yard's shop building.

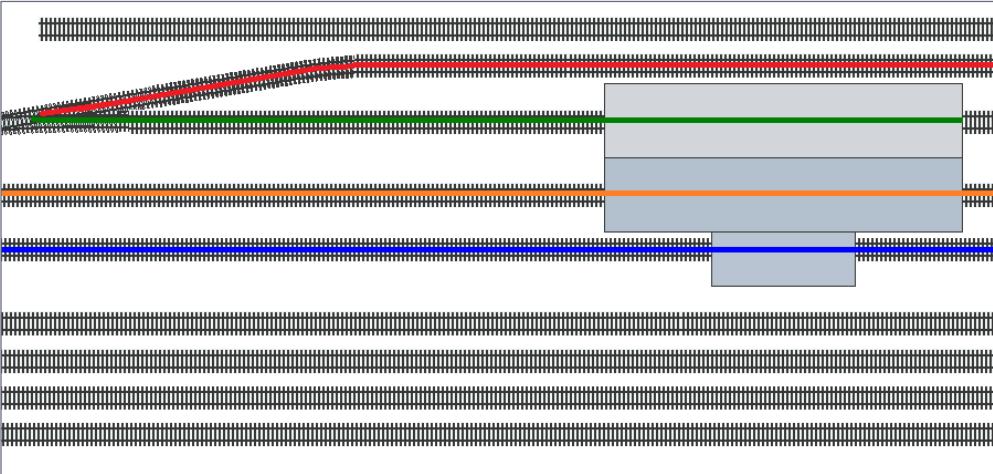

9. My yard track plan with similar trackage to [8].



REGISTER
(free)

[INDEX](#)

[TABLE OF CONTENTS](#)



10. BNSF yard showing where the roundhouse had been.

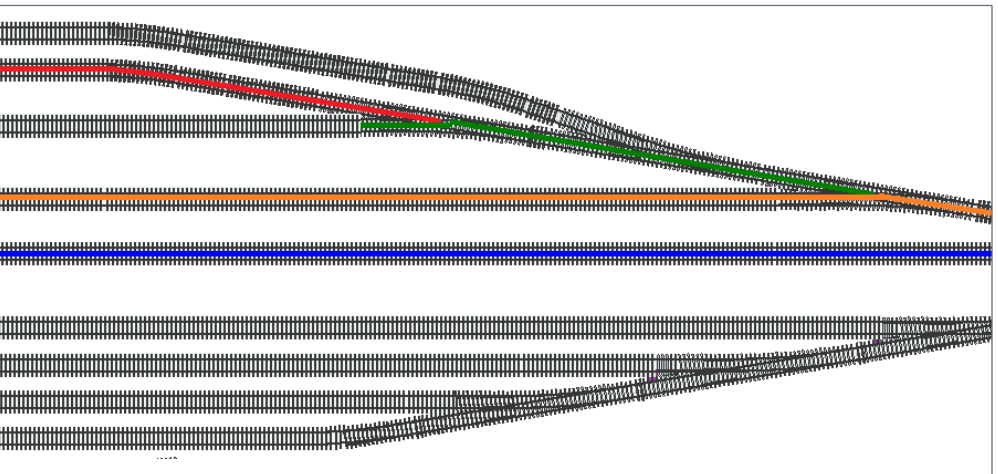

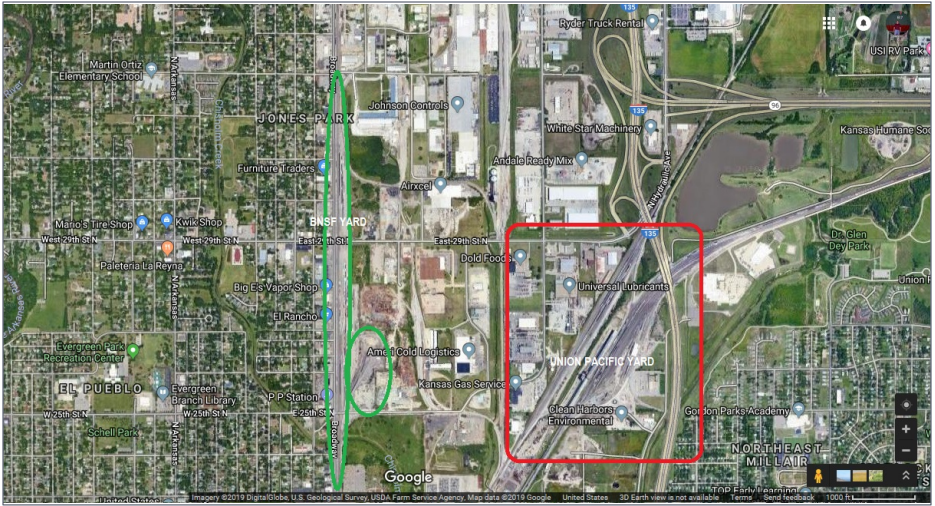

11. BNSF (green) and Union Pacific (red) yards.

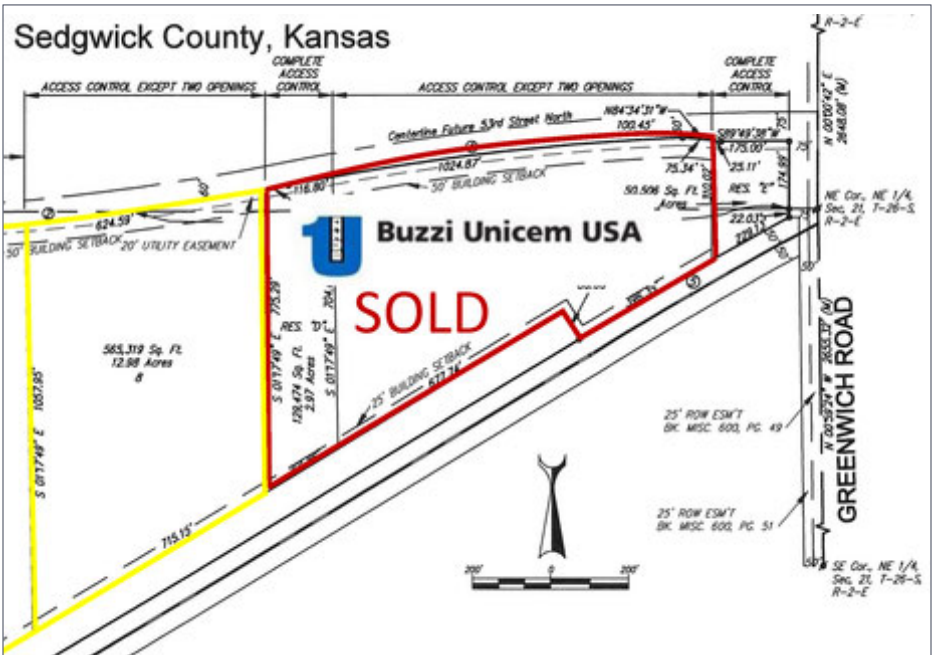

12. Plat map of Buzzi Unicem USA in Bel Aire, Kansas.



REGISTER
(free)

[INDEX](#)

[TABLE OF CONTENTS](#)

YARD TRACK PLAN

The current prototype BNSF yard does not have any service buildings, so I chose to model a modified Union Pacific yard to add operational challenge and call it a BNSF yard.

Follow along as I compare the BNSF yard layout to the UP yard layout [6-11].

The prototype Union Pacific yard has more than 12 parallel storage/classification tracks, as well as engine-servicing and RIP tracks.

My yard track plan has three storage/classification tracks and the engine and RIP tracks. Like the Wichita UP maintenance shop, on my track plan, the main building functions as both an engine service facility and a car shop. I locate motive power fueling on the parallel tracks on the “north” side of the shop (red trackage in [8] and [9]).

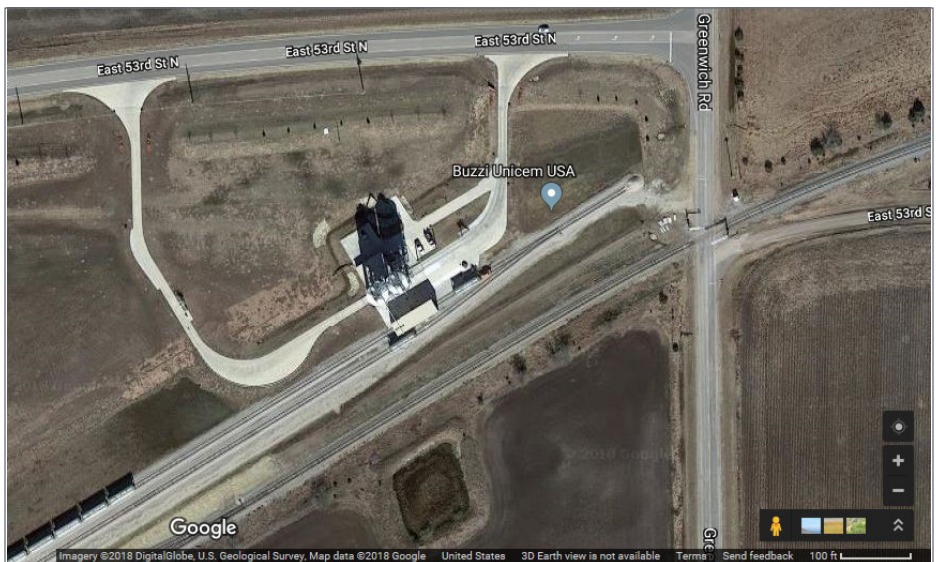

13. Google Maps satellite view of Buzzi Unicem USA in Bel Aire, Kansas.

The track on the “south” side of the shop passes through a lean-to area for light maintenance – that is, a RIP track (blue trackage in [8, 9]).

BUZZI UNICEM USA

Traveling counter-clockwise from the yard we find the Bel Aire Industrial Complex which includes the Buzzi Unicem USA bulk cement terminal. While my wife and I searched for our next German Shepard (our puppy, Jasper), we passed a complex with two large silos and a string of hopper cars on a siding [13], I said to my wife, “That would make a great small industry for our layout.”

At that time, I didn’t know what materials were being shipped to/ from this facility. I did an internet search, starting with a Google



14. Author’s photo of Buzzi Unicem USA in Bel Aire, Kansas.



Maps search of the intersection and learned that it is a Buzzi Unicem USA bulk cement transfer station.

The prototype facility sits on a triangular plot of land by the intersection of 53rd Street (East-West) and Greenwich Road (North-South) where the rail road tracks transverse the area in a West-Southwest – East Northeast direction (approximately 30° to 53rd Street).

To make the facility fit into a smaller footprint, I rotated the railroad tracks to be parallel to 53rd Street. As I developed the BU facility, I tweaked the location of the exit so that it comes out on Greenwich road instead of the prototype facility exiting onto 53rd St. and moved the entire complex closer to 53rd street. Refer to [13] and [16].

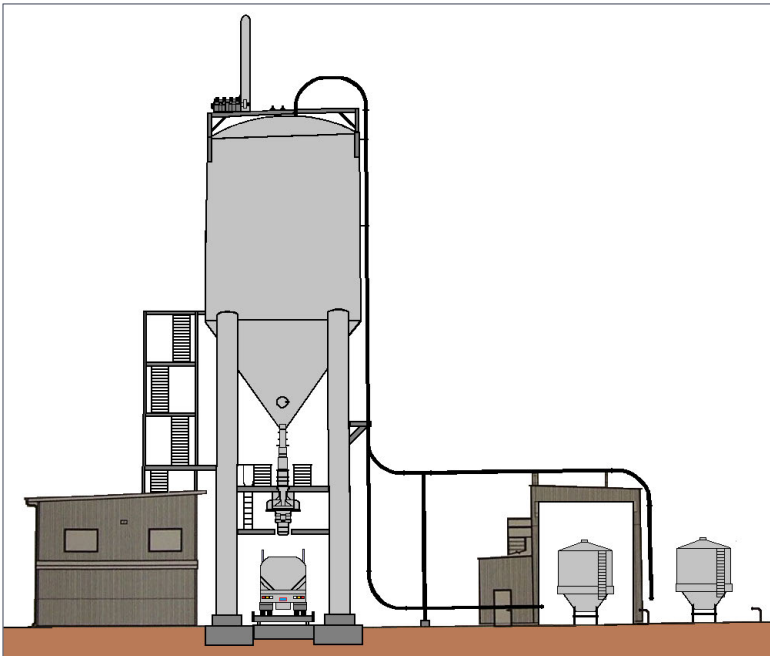

15. Drawing of unloading rail cars/loading semi-trucks.

Buzzi Unicem USA receives cement hoppers only, loads in, empties out. This facility unloads the hoppers by air injection and blows the cement up into the two silos. The majority of the unloading activity takes place from within the enclosed building, you can also see some unloading piping on the exterior of the building.

When a tractor-trailer pulls into the loading dock, the cement feeds into the trailer by gravity, assisted by air pressure to keep the cement flowing.

BEL AIRE INDUSTRIAL COMPLEX

I also wanted to move and switch boxcars, flat cars and tank cars. So I added four more freelanced industries to my Bel Aire industrial complex.

L&L Pipe & Supply is a freelanced, but historic named entity. My wife's father Walter J. Nelson was an oil man, and at one time had an

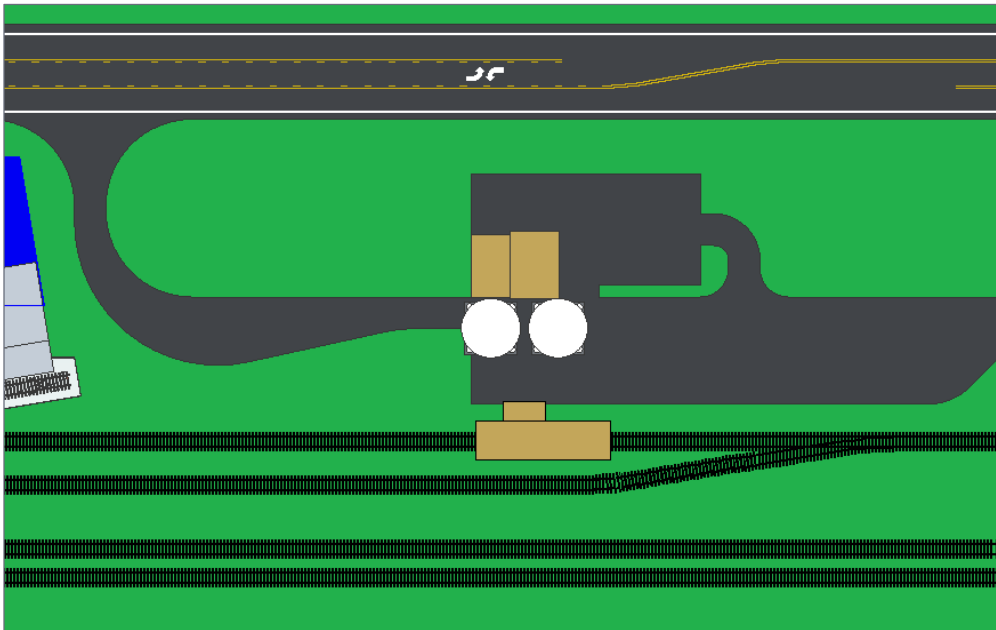

16. Model configuration of Buzzi Unicem USA facility.



oilfield pipe supply company named L&L Pipe and Supply, for his two daughters, Lynne and Lily (my wife). L&L Pipe & Supply on the track plan supplies drill pipe, well casings, well heads, valves, pump jacks, and other oilfield-related equipment. L&L ships these products via highway trucks, boxcars, flat cars, and gondolas (used for the larger well casings).

Vintage Hot Shot is a totally freelanced industry. I previously had experience working on the production side of the oil fields off the coast of Louisiana. I knew the need to get parts from New Orleans to our offshore facility quickly so production was not excessively delayed.

A transportation industry known as Hot Shots uses trucks to transport parts as an urgent short-notice move. I took that basic idea and added Vintage Hot Shot as one of these short notice transportation services operated as a subsidiary of L&L Pipe & Supply. They have their dispatch office in the same building as L&L Pipe & Supply. VHS uses vintage 1950-1960-era trucks, rebuilt and maintained in the shop on the east end of the building.

Lily Logistics is another totally freelanced industry. I named it in honor of my wife, Lily. It acts a trucking distribution center, shipping and receiving packages by truck and rail.

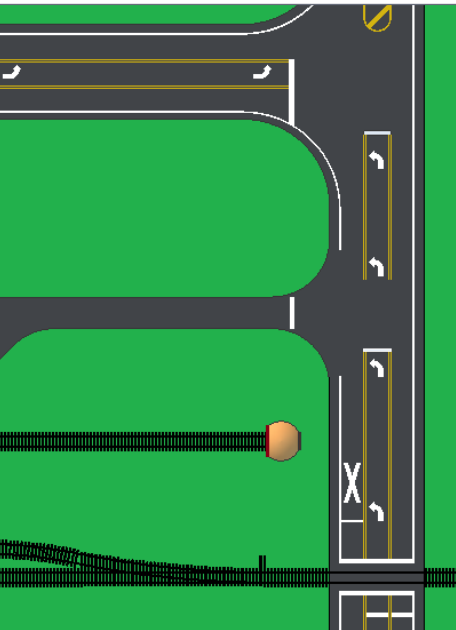



17. DeBruce Grain Inc. (Garvey Grain) elevator complex.

W&J Nelson Oil Co. is a freelanced, but historic named entity. W&J stands for Walter and Jackie Nelson, my father-in-law and mother-in-law. They actually operated a company by this name. On the track plan, it receives fuel products (gasoline, diesel, and LPG) via rail, and distributes locally by truck.

I designed the Bel Aire industrial complex trackage to pose some unique switching challenges.

GARVEY GRAIN

DeBruce Grain, Inc. of Wichita operates a large elevator complex located southwest of Wichita. This grain storage and transfer



REGISTER
(free)

[INDEX](#)

[TABLE OF CONTENTS](#)



18. Andale Ready-Mix, Wichita facility.



19. Andale Ready-Mix cement silos.

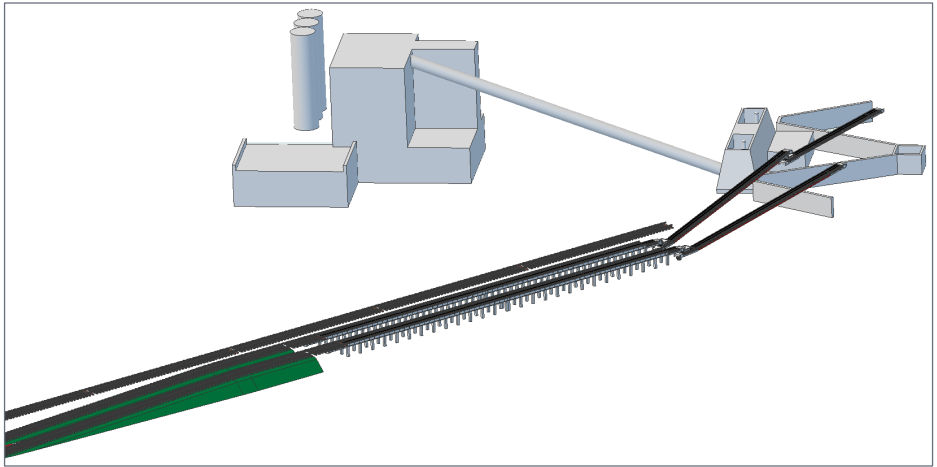

20. Track plan configuration. Conveyors at the end of the trestle carry the dumped material up to the bins.

facility has an elevator complex approximately a half-mile long with three rows totaling 79 35'-diameter silos.

DeBruce Grain, Inc. used to be Garvey Grain, and since I inherited several hopper cars with Garvey Grain reporting marks, I am referring to this grain elevator as Garvey Grain.

Covered hoppers are switched into and out of Garvey Grain. For the track plan, I am using the grain elevators as a backdrop flat industry. I'm modeling only a portion of the entire complex with only one row of silos.

ANDALE READY-MIX

Andale Ready-Mix is a cement batch plant. On my track plan, it receives cement from the Buzzi Unicem USA terminal via truck, which unloads the cement into three raised cement silos. They receive the concrete aggregates by rail on my plan (the prototype receives aggregates by truck only).



REGISTER
(free)

[INDEX](#)

[TABLE OF CONTENTS](#)



21. Satellite view of Spirit Aero Systems Wichita, Kansas.

On my plan, Andale Ready Mix has dual parallel unloading tracks with a conveyor belt under them to assist in rapid unloading of the hopper cars. Three to four hopper cars can be spotted onto each raised unloading track [20].

SPIRIT AEROSYSTEMS PLANT 2

At Spirit AeroSystems, empty 89' flat cars go into the four tracks of Plant #2 where a fuselage is loaded onto each empty flat car. Once loaded with the fuselage assembly, each car can be pulled out of the building, pushed onto a siding track and an empty car can be pushed into the building.



22. Closeup satellite view of Plant 2 trackage.

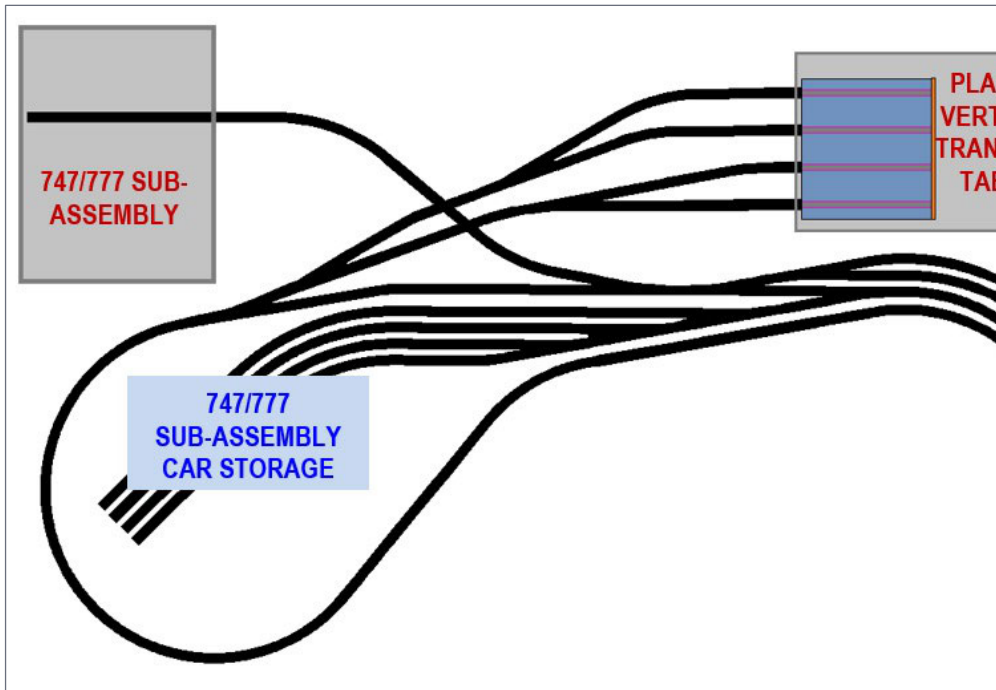

REGISTER
(free)

[INDEX](#)

[TABLE OF CONTENTS](#)

The same activity takes place with the 747/777 sub-assembly cars. Once the “empties” train (from Renton) has been disassembled, the loaded cars are built into a train destined for Renton, Washington.

On the track plan, I’m modeling the main 737 Fuselage assembly building (Plant #2) and the 747/777 sub-assembly building and I have repositioned them so that they fit into the layout easier and take us less real-estate than the prototype.

Operationally, I want the four (4) loaded 737 fuselage flat cars pulled out of Plant #2 tracks and the 747 and 777 sub-assembly cars to pull out of another building. The “loaded” 747/777 sub-assembly cars are positioned at the front of the outbound train with four fuselage flat car – idler flat car combinations to make up the rear of the train.

Once the outbound train has been made up, it can be pulled out onto the main line and circle the layout, then goes down the 3% grade to the lower deck Renton area where it is disassembled.

There I can swap full fuselage flats with empty fuselage flats of the same reporting marks.

Then I make up an empty inbound train that travels back up the 3% grade to Spirit Aero Systems. The switching job disassembles the inbound train and swaps empty fuselage flats with loaded fuselage flats.

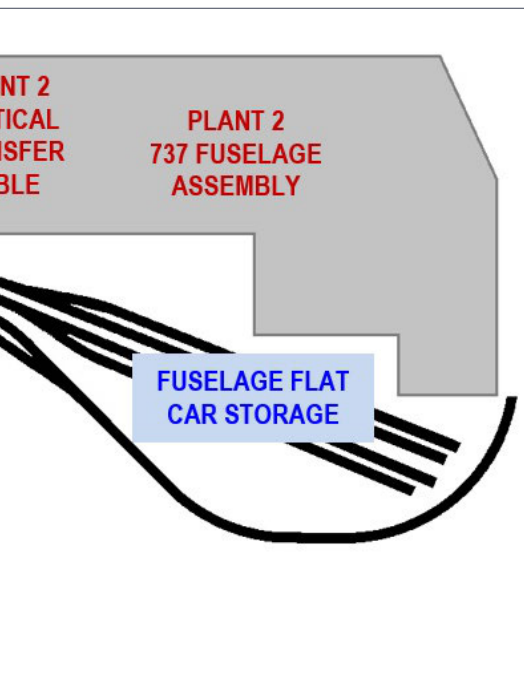

RATE THIS ARTICLE

23. Track plan configuration of Spirit Aero Systems trackage.

The track plan of Plant 2 building uses the building to hide the scissor-jack vertical transfer table to move Load/empty cars between Renton and Wichita. This gives much switching operation as well as removing the need to hand-carry the cars – all train movements can be accomplished by cars and locomotives remaining on the tracks.

At the beginning of an operating session, the four plant #2 tracks would have “loaded” fuselage flat cars in the building (on the scissor jack). These “loads” would be pulled out of the plant and empties would be pushed into plant #2, ready for newly constructed fuselages. The train to Renton would consist of the “loaded” 747 sub-assembly and 777 sub-assembly cars (special-built well cars with weather proof covers), are located behind the engines. The four loaded fuselage cars, with idler flats between, are located behind the sub-assembly cars. This train would traverse the layout a couple of times to give the impression of traveling across-country. It then takes the 3% grade down to the lower level (Renton, Washington), where it is broken up.



24. 737 fuselages on flat cars with brush-cutter buildhead, and idler flat.





25. Train with two 747 sub-assy, and one 777 sub-assy cars with four 737 fuselages.

The scissor jack (with the four empty flat cars) is lowered to the second level. The crew then pulls a flat off the scissor jack table, and replaces it with a loaded fuselage flat. Each fuselage flat must be handled individually with an idler flat because of the large overhang of the fuselage. Once each of the four fuselage flat cars are placed on the scissor jack table, it then can be raised back up to Wichita Plant #2.

The train of empties to Wichita has been assembled and the engines only need to run around the train to get into the proper position to return to Wichita.

So that's my track plan for a 24' x 24' space, fitting into a garage, for instance. You can find track plans in the bonus extras, as well as a detailed operating plan for the aircraft plant's empties-in, loads-out scheme.

★ ★ ★ ★ ★
RATE THIS ARTICLE

DEREK DUNCAN



Derek got an 0-4-0 HO TYCO train set for Christmas when he was 11-years-old. That started him down the road to model railroading and a lifetime interest in electricity. As a freshman in high school shop, he built a 4' x 6' train table, but when he went to college all his train stuff was boxed up.

In 1989 he received two bachelor's degrees (Electrical Engineering Technology and Computer Science Technology). After graduation he was hired by an aircraft company in Wichita, Kansas, and was a power generation/distribution engineer for 30 ½ years.

Later he married, built his career, had a child and stopped doing any railroading.

A couple of years ago he ran across model railroad YouTube videos (including "What's Neat this Week") and became interested in modeling again.

Derek is married to his wife Lily, and they have one adult son.

He currently is working as a power distribution engineer for an aircraft company out of Oklahoma City. They purchased a home there with a dedicated "Train Room" over the 4-car garage. ■





D. Duncan

WHAT'S A VERTICAL TRANSFER TABLE?

The vertical transfer table is a commercially available scissor jack (~\$70, Amazon, [see article shopping list here](#)). Transfer up/down can be done manually, or the hand knob could be replaced with

a motorized belt drive apparatus with automatic up/down stops.

This scissor jack from Amazon has a 10.1" travel. An 18" x 18" plate could be mounted on the scissor jack top plate to hold the four tracks. You can either glue the four parallel tracks to this plate, or get fancy and mill slots in a hardwood or aluminum plate for the wheels to ride on.

This transfer plate does not need to be powered, as only the fuselage flat cars will be moved on or off it. No engine should run onto the transfer table.

There will need to be some sort of stop for each end of the transfer table tracks to prevent the rail cars from rolling off while being moved up or down.

One simple idea would be to predrill some holes for push pins on both ends of each track. Then once the transfer table has been ramped up, pull the pins out of the open door end to allow switching cars in/out. Note you can leave the push pins on the other end as stops.

When you're ready to ramp the transfer table back down, push the pins back in first. Just reverse the process once the table has been ramped all the way down.

I'm sure some of you could envision even fancier ways of handling this.

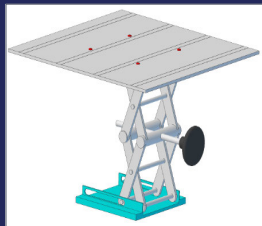

24. Vertical transfer table.

~~2.99~~ ~~1.99~~ ~~.99~~ ~~.49~~ ~~.42~~
regular issue price



RUNNING #####**EXTRA**

Apprentice with savvy modelers

Subscribe today - 36 issues, \$29.99

Next 12 issues for \$19.99 + \$10 for all 24 back issues

Just 42 cents / back issue

~4000 pages of all-meat articles!

**Special pricing extended due
to overwhelming response!**

Current subscriber and want all the back issues for a super low price?

You should have gotten an upgrade offer email - if not, select the button below:

I didn't get an upgrade email

store.mrhmag.com



REGISTER
(free)

[INDEX](#)

[TABLE OF CONTENTS](#)



LOOK

column



JEFF SHULTZ LOOKS AT THE EAST COAST CIRCUITS RICKO DODGE CHARGER POLICE CAR ...

EAST COAST CIRCUITS MODIFIES 1:48, 1:87, and 1:160 scale vehicles from a variety of manufacturers, such as River Point Station, Ricko, and Scenemaster, by adding LED lights to them.

On their newest offering, a 1:87 Ricko Dodge Charger police car, East Coast Circuits has added up to 16 LED lights, depending on the specific car model.

The Sheriff's car I received has 14 LEDs, including red taillights and white headlights, an interior light bar in the back window with six separate blue and red LEDs, blue and red LEDs in the light bar on top of the car, and a blue and a red LED in the windshield.

THE NICE THING

Powered by a 9-12V DC power source, such as a 9V battery, the lights seem almost hypnotic in their flashing, with the taillights

and headlights going from steady to strobing, the blue and red LEDs in the windshield alternating, the LEDs in the roof light bar alternating and strobing, and the six LEDs in the back window flashing in three distinct patterns.

The power connects to the LEDs via a two-foot cable of two twisted magnet wires attached to the bottom of the car. The polarity of the connection is fixed, with the red wire positive and the green wire negative. The ends of the wires come pre-stripped.



1. The front of the Charger with a long-exposure shot to get all the LEDs illuminated. The 14 LEDs make this car an attention-getter.



2. The side of the Charger.



REGISTER
(free)

[INDEX](#)

[TABLE OF CONTENTS](#)

FIRST LOOK | 3

Click on the video below to see it in action. The models will be available for \$85 - \$90, including shipping, depending on the version purchased.



3. The back of the Charger.

Watch on



Play this video



East Coast Circuits Police Car
December MRH companion video



180-degree view of the Charger with the LEDs flashing.



The Amherst Railway Society Railroad Hobby Show

On 2021 ... will be

CANCELLED
January 30 & 31, 2021

Save the dates!

**Click
to learn
more ...**



REGISTER
(free)

[INDEX](#)

[TABLE OF CONTENTS](#)

SAVVY MODELER *Online*



RATE THIS ARTICLE

Model Railroad Hobbyist | December 2020



WATCH
THE
VIDEO
click here



Play this video

Watch on



Make uneven music wire perfectly straight

Pupeteers *Alex and Olmsted* demonstrate how to take music wire that comes in rolls or is unevenly twisted into wire that's 100% perfectly straight. Watch the video and see how easy it is to do!

Don't be put off by this being a video by pupeteers instead of model railroaders. A lot of other hobbies and professions have great how-to videos like this loaded with some great tips! ■



GREAT MODELER VIDEOS ON THE WORLD WIDE WEB



ALLAGASH



Up close and personal :2

The Carthage Turn

GET IT NOW >>

download or DVD

store.mrhmag.com

**Model Railroad
Hobbyist** *Store*



REGISTER
(free)

[INDEX](#)

[TABLE OF CONTENTS](#)

DECEMBER NEWS

column



Model Railroad Hobbyist | December 2020

RICHARD BALE AND JEFF SHULTZ
REPORT THE LATEST HOBBY
INDUSTRY NEWS ...



NEW PRODUCTS FOR MULTIPLE SCALES

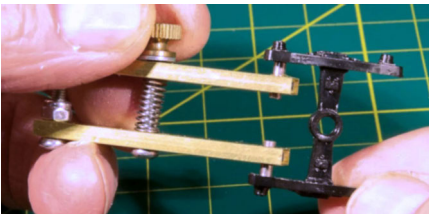

Coffman Graphic Solutions has introduced an innovative new tool that takes the guesswork out of determining the most efficient axle length for replacement wheel sets.

The new Coffman Truck Caliper is available for seven scales: N, HOn3, HO/Sn3, S/On3, and O scale. For additional information visit www.coffmaneng.com.



Dwarvin has introduced the Lamplighter 2S. Based on the Lamplighter 2 and capable of holding up to 30 1.5mm fibers or 60 1.0mm fibers, the Lamplighter 2S has double the light intensity and is

THE LATEST MODEL RAILROAD PRODUCTS, NEWS & EVENTS

DECEMBER MULTIPLE SCALES | 2

a whiter light source. For more information visit www.dwarvin.com.



miniprints continues to expand its selection of high-quality multi-scale 3D printed figures. The newest line includes the CustomCrews figures, modeled after modern railroad employees.



All miniprints figures are available in O, S, and HO scales, with a selection now available in N scale. For details on purchasing items, such as the November figures seen

above, through an economical monthly subscription program visit miniprints.ca/subscriptions.

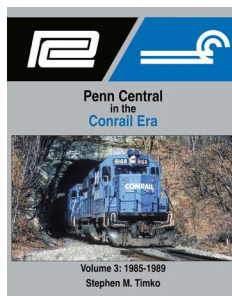
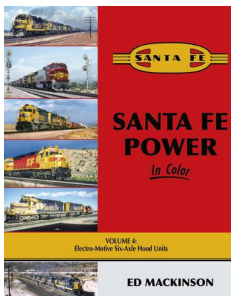

New hardback books scheduled for release during the Christmas season by **Morning Sun Books** include *Santa Fe Power in Color, Volume 4: Electro-Motive Six-Axle Hood Units*, by Ed Mackinson. For many years,

six-axle Electro-Motive road switchers were the backbone of



REGISTER
(free)

[INDEX](#)

[TABLE OF CONTENTS](#)

Santa Fe's mainline freight service. This new volume features them all, from the SD24s of 1959 to the Warbonnet SD75Ms of Santa Fe's final days.

Morning Sun also plans to release *Penn Central in the Conrail Era Volume 3: 1985-1989* during the holiday season. In this volume author Stephen M. Timko explores former Penn Central territory under the control of Conrail between 1985 and 1989. Former PC motive power, equipment, and structures are featured, along with freight operations. Over 335 full-color photographs are presented. For additional information contact a dealer or visit www.morningsunbooks.com.

O SCALE PRODUCT NEWS



3rd Rail Division of Sunset Models is booking reservations for O scale EMC Santa Fe E1 A and B units and Baltimore & Ohio

EA/EB diesel units. The models will be individually crafted using an ABS body with full cab interior, precision 5-pole DC skewed armature motor, and a ball-bearing drive mechanism with all units powered.



ERR Cruise, Railsounds & Smoke sound systems will be available in 3-rail units. Two-rail units

will utilize QSI "Titan" DC/DCC and Sound.



These museum quality models will be built to reservation only. For more information visit

<http://www.3rdrail.com>.

Atlas O is calling for pre orders for two popular O scale freight cars scheduled for release during the 3rd quarter of 2021. Heading the list are three versions of a Trainman series 62' flat car with tall, short, and no bulkheads.



Cars with short bulkheads will be available decorated in two TTX schemes.



Models with tall bulkheads will be available for BNSF, GAEX-General

American, and two TTX schemes. Notable details on the bulkhead cars include side stake pockets, simulated tie-loops, and prototypical pull-plates and lift rings.



Road names for the flat car will be TTX, DODX-Department of Defense, and Norfolk Southern.

Atlas O will re-issue its popular 40' wood reefer car in several familiar paint schemes. The O scale model represents



REGISTER
(free)

[INDEX](#)

[TABLE OF CONTENTS](#)

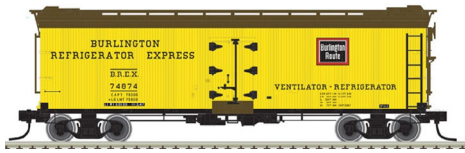

prototype wood reefers that were re-built and modernized at various stages of their service life and remained in service into the 1940s.



Decorating schemes will be Burlington Refrigerator Express, Lackawanna Refrigerator Line, Pacific Fruit Express, Fruit Growers Express, Roberts & Oake Packers, and Western Refrigerator Line. Atlas O rolling stock is available with a choice of 2-rail or 3-rail trucks and couplers.



Also expected during the 3rd quarter of next year is another release of Atlas' operating oil pump. The action model will be available decorated in black

as well as the two free-lance schemes shown here. The O scale model comes fully assembled and wired. It requires an 8 to 22 volt AC or DC power supply (not included). For additional information contact a dealer or visit www.atlaso.com.



Ipswich Hobbies has introduced two new O scale craftsman structure kits. Both of the laser-cut kits are based on actual

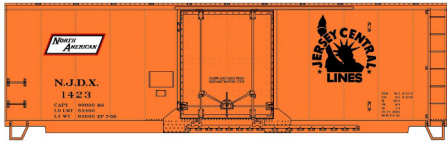

This 40' insulated all-steel boxcar entered service on the Central Railroad of New Jersey (aka Jersey Central Lines) in 1932.



Accurail's HO scale kit for this ACF Norfolk & Western 4650 cu. ft. Center-Flow covered hopper follows a full-size

triple bay car built in 1964. The fine print on the side of the model reads: POLYCLUTCH LINING APPLIED 8-64. DO NOT USE STEAM BOILING WATER OR SHARP OBJECTS TO CLEAN. ENTER CAR WITH RUBER SOLED SHOES ONLY.



This HO scale Nashville, Chattanooga & St. Louis 40' steel boxcar is based on a prototype built in early 1942. All Accurail HO scale kits

include Accumate knuckle couplers and appropriate trucks with Delrin wheelsets. For additional information contact a dealer or visit www accurail.com.



R. Bale

SD70ACU LOCOMOTIVE

The 4,300hp SD70ACU diesel was created in 2015 when the Norfolk Southern Railway launched a program to update its EMD SD90MACs. The rebuild included installation of the latest EMD cab to comply with FRA crash-worthiness standards, replacing the Siemens electrical control package with Mitsubishi electronics, and completely refurbishing the V16 710 prime mover. Most NS rebuilds had rear ditch lights added and modifications to the location of the horns, headlight and antenna array. In 2018, the Canadian Pacific Railway began a similar rebuild program for its SD90MAC fleet, which was performed by Progress Rail. In addition to new electronics and cab, CP changed the front plow and raised walkways for better snow management.



Athearn plans to release SD70ACU diesel units next November. The fully featured HO scale models will be in Athearn's Genesis 2.0 line.



Canadian Pacific models will be available in several distinctive paint jobs including CP red with the new Beaver logo, and a gray and maroon heritage unit with script lettering.



Inspired by Canada's military forces, CP SD70ACU models will be available decorated in Canadian Army desert sand. The Royal Canadian Navy will be saluted with a SD70ACU decorated in RCN shipside grey and oxide red.



Athearn's Norfolk Southern version of the SD70ACU will feature deck mounted rear ditch lights, a prototypically correct 5-chime horn, high mounted headlight, and an NS style PTC antenna. All versions of the HO scale model will be available without sound and with an onboard DCC decoder with SoundTraxx Tsunami2 sound.



Athearn's November 2021 schedule lists three new freight cars including a Genesis series ICC caboose. Road names for the feature-laden caboose will be Burlington, Burlington Northern, Colorado & Southern, and Fort Worth & Denver.

In addition to LED interior lighting, the DCC equipped cabooses will offer a variety of sounds such as air horn or



REGISTER
(free)

[INDEX](#)

[TABLE OF CONTENTS](#)



trainline air whistle, rail clickety-clack, brake set/release sounds including brake squeal, and adjustable flange squeal.



R. Bale

PULLMAN STANDARD 60' AUTO PARTS CAR

In the 1960's, the Santa Fe Railway, Ford Motor Company, and Pullman Standard, pooled their resources to develop a standard boxcar to meet the transportation needs of automobile manufacturers in the United States. Delivered in 1965, the Pullman Standard 60' auto parts boxcar became a prime example of this type of freight car. Many had two eight foot wide doors to facilitate forklifts rapidly loading and unloading the car. The design ultimately changed the face of automobile manufacturing and rail transportation.

Athearn has included a Genesis series 60' PS auto boxcar in its production schedule for next November. Features of the HO scale model include a detailed cushion underframe, etched metal coupler platforms, separately applied door closure rods, side ladders, metal grab irons and brake cylinder; etched metal end platforms, coupler lift bars, trainline and brake hoses, and 100-ton roller-bearing trucks with machined metal wheels and rotating bearing caps.



Road names will be Chicago, Burlington & Quincy; Milwaukee

Road, Louisville & Nashville, Norfolk & Western, Frisco, and Southern Pacific.

The third new freight car coming from Athearn next November is a basic 60' flat car. The Ready-to-Roll HO scale model will be



available in three road numbers each for Southern Railway, Canadian National, Canadian Pacific, BC Rail, BNSF, Southern Pacific, and three TTX schemes.



New intermodal equipment on Athearn's November 2021 delivery schedule includes a 40' Z-Van trailer with a new Thermo-King reefer unit mounted on the nose of the trailer. Carrier names will be Digby's Golden Arrow Route, Intermodal Systems, Leaseway Transportation, Martrac, Rock Island, and an unlettered owner operator unit. The trailers will be available individually as well as in combination with a Genesis F89 flat car.



Both yellow and brown versions of the TTX flat car will be available. They will have positionable hitches, wire grab irons, individual brake ratchet, and 70-ton roller-bearing trucks with metal wheels and rotating bearing caps. A minimum track radius of 24" is recommended. The Rock Island and Digby's trailers will be available with a brown TTX F89 flat car. Z-Van trailers decorated for Leaseway and Intermodal Systems will be available with yellow TTX flat cars.



Athearn plans to release HO scale versions of the IMPACK (Inter-Modal Package) spine car next November in four, five and ten car sets. The models are based on the unique "Fuel Foiler" cars built by the Santa Fe in 1978. The Fuel Foilers were designed to carry 40' to 45' trailers in 4 to 10-car sets. Athearn will offer the HO scale version of the spine car decorated for Burlington Northern, Itel, Santa Fe, TTX, and SSW-Cotton Belt.



REGISTER
(free)

[INDEX](#)

[TABLE OF CONTENTS](#)



The November 2021 production schedule for Athearn concludes with a Roundhouse brand 34' twin-bay coal hopper with ribbed sides. The economy priced model will be fitted with appropriate trucks with metal wheels. Road names will be Pennsylvania, Baltimore & Ohio, New York Central, Lehigh Valley, Norfolk & Western, BNSF, and Chesapeake & Ohio. For additional information contact a dealer or visit www.athearn.com.



Atlas is booking pre-orders for an all-new 5250 cu. ft. covered hopper. The HO scale Master series model is based on a prototype introduced by ACF in 1964.



The majority of the nearly 20,000 cars built were equipped with pneumatic outlets and eight 20" round hatches; two features designed to facilitate handling plastic pellets. The overall design evolved over the years with many of the plastics cars being rebuilt with gravity outlets and elongated hatches for grain type products. Accordingly, Atlas will offer three unique body style variations to represent those changes from the 1960s into the 2000s.



Road specific variations on the three body styles include hatch and outlet configurations, and types of roof walks. Additional features of the new model include etched metal roof walks, metal knuckle couplers, separately applied wire grab irons and wire brake lines, etched metal coupler crossover platforms, and 100-ton roller-bearing trucks.

Road names on Atlas' initial release will be CHEX-Chemplex Plastics, NDYX-Arco Polymers, ACFX-Honeymead, ADMX-ADM



Molecule, HPCX-Hercules Pro-Fax, and GACX-General American. Availability is planned for the first half of 2021.

Also new from Atlas is an HO scale 10-1-12 Pullman heavyweight sleeper. By the late 1920s Pullman had built over 600 cars to the 10-1-2 (10 section, 1 drawing room, 2 compartment) 3585 plan making it the largest

class of cars except for the ubiquitous 12-1 sleeper.

Collectively, cars of plan 3585 became known as the "Lake"

series of cars, as the majority of them bore names of lakes in the United States.



Features of the new Atlas HO scale sleepers include full interior

detailing, operating diaphragms, prototype-appropriate air conditioning details, underbody details, and six-wheel passenger trucks with metal wheels. Atlas recommends a minimum track radius of 24".



Three Lake series names will be available for Pennsylvania (Tuscan

red), Southern Railway (green and black), Union Pacific (yellow, grey and red), and Southern Pacific (Pullman green and black). Lehigh Valley cars, in LV red, will be available in choice of two Lake names. Cars lettered for Pullman will be available in six different Lake names. An unlettered sleeper in Pullman green will be available along with one car lettered for México SCD.

Atlas' 3rd quarter production schedule for 2021 includes a rerun of its Alco S-4 switch engine with a retooled cab. The HO



REGISTER
(free)

[INDEX](#)

[TABLE OF CONTENTS](#)



scale Master series model is based on a 1,000hp prototype Alco introduced in 1950.



The upgraded model features separately-applied grab irons, coupler cut levers, air hoses, and piping; redesigned AAR type truck frames, directional LED lighting, and a retooled chassis to accommodate DCC and sound.



Road names include Baltimore & Ohio, Boston & Maine, CP Rail, Grand Trunk Western, Pennsylvania Railroad, Santa Fe, Southern Pacific, and undecorated.



DC models will be equipped with a speaker and an 8-pin socket for conversion to DCC/sound with the addition of an aftermarket decoder. DCC versions of the S-4 will have an ESU LokSound Select Dual-Mode decoder.



Completing Atlas' 3rd quarter 2021 production of HO scale models are three versions of a Trainman series 68' fishbelly flat car. Details include individual side stake pockets, simulated tie-loops, and lift rings.



Models with standard (tall) bulkheads will be available for BNSF, GAEX- General American, Boise Cascade, and two TTX schemes. Road names for models with short bulkheads will be Colorado & Wyoming, and two TTX schemes.

Road names for a flat version without bulkheads will be Union Pacific (MOW green), DODX Department of Defense, and TTX. Each of the three types will also be available undecorated. For additional information contact a dealer or visit www.atlasrr.com.



R. Bale

EMD SD60 SERIES DIESELS

The EMD SD60 is a 3,800hp, 6-axle diesel electric locomotive designed for heavy-duty drag freight and medium-speed freight service. The SD60 was introduced by EMD in 1984 with production continuing until 1995. If the cab on the standard cab SD60 looks familiar it is because it is the same cab EMD used on its SD40-2.

Variations on the versatile SD60 locomotive include the SD60I with a full-width short hood and a sound insulated WhisperCab; the SD60M with a short full-width hood and a North American safety cab with a three-piece windshield; the similar appearing SD60MAC equipped with AC traction motors; and the home-built Norfolk Southern SD60E that featured an NS-designed wide nose cab with increased crash protection, new electronics, and rebuilt engines rated at 4,000hp. GMD built SD60F units for Canadian National with a full-width cowl body and a crashworthy safety cab with a four-piece windshield.



Aurora Miniatures has announced plans to produce an HO scale Canadian

National SD60F diesel electric locomotive. Aurora is an established Chinese manufacturer of mostly domestic prototypes for the broad Asian market. The HO scale SD60F is Aurora's first model of a North American prototype. To service



REGISTER
(free)

[INDEX](#)

[TABLE OF CONTENTS](#)

North American customers Aurora has opened an office in Canada in Scarborough, Ontario.

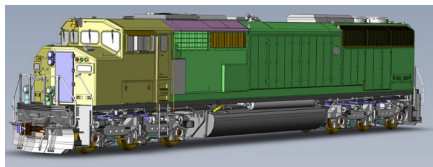

Separately applied details listed in Aurora's SD60F announcement include individual windshield wipers, grab irons, handrails, steps and

ladders, lift rings, bell, horn, winterization hatch, radiator screens, mirrors, sunshades, plow, MU hoses, train line hose, coupler cut lever, sanding lines, handbrake chain, fuel tank, and underbody cables and piping. Of special note are operating radiator fans driven by an auxiliary motor that uses a double worm gear system to achieve appropriate fan speed.

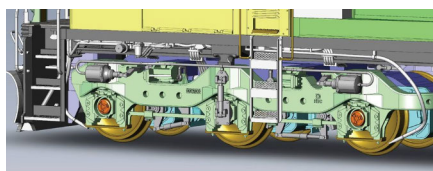

Aurora's SD60F will have GMD/Dofasco HT-C trucks with traction motor detail, separately applied brake details, and rotating roller-bearing end caps.

Lighting functions will include headlights, ditch lights, number boards, tri-color classification lights, step lights, ground lights, walkway lights, and locomotive control desk lights. The locomotive will have Kadee-compatible proprietary couplers with scale size heads. Aurora will offer the SD60F for DC operation as well as DCC and DCC sound with a factory installed ESU LokSound 5 decoder. All units will have dual sugar cube-type speakers with enclosures. An optional smoke unit for installation by the hobbyist will be available as a separate purchase.



Decorating schemes will include CN stripes, CN wet noodle with a North

American map and CN wet noodle with the CN.NA website.

Availability is planned for summer 2021. Aurora is currently in the process of establishing a dealer network. For the latest listing visit auroraminatures.com/dealer-listing-canada.



Bachmann has released an upgraded version of its HO scale cable car. Improvements for the self-propelled model include a revised drivetrain. In addition to a Christmas theme, the ready-to-run model is available decorated for Powell & Hyde Street, Washington & Jackson Street, and Powell & Mason Street. For additional information contact a dealer or visit www.bachmanntrains.com.



Con-Cor's HO scale 2020 Christmas model is a pair of 53' containers. The switch by Con-Cor to containers for the Christmas model was prompted by inconsistent deliveries from China of some car parts. To purchase the holiday models visit www.con-cor.com.



Credit Valley Railway is taking reservations for a Bowser 40' steel boxcar custom decorated for Canadian National. The brake rigging, safety appliances, and decorating scheme represent a car built in 1940 with Youngstown doors. For additional information, including reservations, visit www.cvrco.ca/CVSearch/default.aspx?Manufacturer=161&start=A161-2-5978&end=A161-2-5981.



RATE THIS ARTICLE



REGISTER
(free)

[INDEX](#)

[TABLE OF CONTENTS](#)



R. Bale

C&O L-1 HUDSONS

The Chesapeake & Ohio was slow to invest in passenger diesels in the early 1940s, and as the nation's railways emerged from WWII, C&O's black steamers looked ancient compared to the competition's colorful diesels. In an effort to appear more up to date, in 1946 the C&O rebuilt five of its 4-6-4 Pacifics with 4-wheel trailing trucks, converting them to class L-1 4-8-4 Hudsons. Four of the five new Hudsons were clad with stainless steel shrouding including the boiler which was painted orange. The tenders were fitted with fluted stainless steel sheathing that curved at the top to match C&O's new Budd passenger cars. After C&O took over the Pere Marquette Railway, the boilers of the L-1s were repainted yellow. C&O engine No. 490 survives today at the B&O Railroad Museum in Baltimore, MD.



HO scale model is a combination of a brass superstructure and a diecast chassis.



New releases coming from **Broadway Limited** this month include several versions of a Chesapeake & Ohio class L-1 streamlined 4-6-4 Hudson steam locomotive. Construction of the

BLI's streamlined C&O Class L-1 Hudson will be equipped with Paragon3 Sound and Operating System featuring Rolling Thunder.

The model will be available in the original orange boiler as well as with the later yellow boiler. An unlettered model



painted brass will also be available. For additional information contact a dealer or visit www.broadway-limited.com.



InterMountain has released eight versions of

a 60' flat car with a wood deck. Road names on the HO scale model are Illinois Central, Norfolk Southern, Soo Line, Canadian National, Nacionales de México, and three HTTX schemes.



The ready-to-run models come with appropriate trucks with machined metal wheels.



For additional information contact a dealer or visit www.intermountain-railway.com.



Kadee's Christmas model for 2020 is a specially decorated P-2 twin-bay covered hopper.



The newest addition to Kadee's regular line of HO scale ready-to-run models is this Chicago Great Western 40' PS-1 boxcar. The model accurately represents a prototype Pullman Standard built in 1951 with Youngstown sliding doors. It was also equipped with specialized internal loading fixtures. Kadee has decorated the model as it was repainted in 1959 with a black roof.



REGISTER
(free)

INDEX

TABLE OF CONTENTS



Also new is a 50' Chicago and North Western PS-1 boxcar with an 8' six-panel Superior door. All Kadee ready-to-run models come with Kadee couplers and two-piece self-centering trucks. For additional information contact a dealer or visit www.kadee.com.



KatoUSA has added the late Phase V paint scheme of the GE P42 to its stable of Amtrak Genesis locomotives. The HO scale model is available for DC operation or with factory installed ESU Loksound DCC and sound. Additional features include directional headlights and taillights on both the front and rear of the locomotive and illuminated pre-printed number boards. The model is powered by a pair of coreless truck-motor drive units. For additional information contact a dealer or visit www.katousa.com.



New 1:87 scale vehicles scheduled for release this month by **Oxford Diecast** include this 1942 Chrysler Town and Country Station Wagon. The maroon and wood model features a roof rack and broad white wall tires.

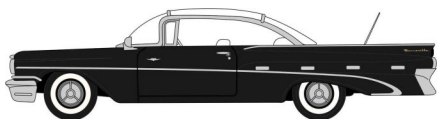

Also due for release in December is a 1959 Pontiac Bonneville Coupe in white over black.



Completing Oxford's list of new 1:87 scale vehicles is a California Highway Patrol scheme applied to a 1954 Pontiac Star Chief sedan.

Since California did not approve of white wall tires on state vehicles, meticulous hobbyists may want to paint the tires black. For additional information contact a dealer or visit www.walthers.com.



Summit USA has released an HO scale kit for a Starbucks Coffee restaurant with a drive-thru. The kit consists primarily of pre-cut and milled styrene, laser-cut white acrylic and self-adhesive

micro-plywood, window glazing, logo signs and decals, and illustrated assembly instructions. The completed building has a footprint of 8" x 4.75" x 3.25" high. The parking lot base, cars, vehicles, and landscaping are not included. For additional information visit www.summit-customcuts.com.



R. Bale

BILEVEL COMMUTER CARS

The contemporary North American Bilevel Commuter Car was introduced in the mid-1970s. The cars are currently in service on 14 transit agencies in Canada and the United States. The Bilevel design resulted from a request by the Government of Ontario to develop a higher-capacity solution for commuter trains in Toronto where the city's single-level commuter trains had grown to 10-car trains. It was determined that the solution was to increase the height rather than length of the trains. Built by Hawker-Siddeley of Canada, the first cars went into service on Toronto's GO Transit system in 1976. The cars have since been manufactured by Urban Transportation Development Corporation (UTDC), SNC-Lavalin, and currently by Bombardier. The first cab units came on line in 1983. The Bilevels are constructed with a riveted or welded aluminum body on a steel frame. Depending on the internal configuration, capacity of the 85' cars ranges from 136 to 162 seated passengers.



REGISTER
(free)

[INDEX](#)

[TABLE OF CONTENTS](#)



Rapido has announced plans to produce six different versions of North American Bilevel Commuter Cars. The HO scale models will replicate series I, II and IV of the popular prototype.

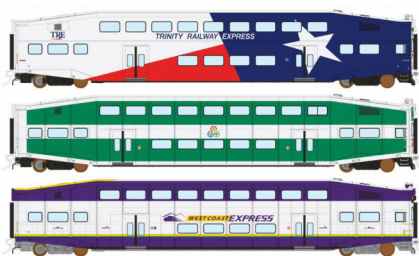

Specific details include body shell designs with or without rivets, five or four windows on the lower level as appropriate to the series, tinted windows, metal grab irons, constant interior lighting, controllable cab car

lighting, and detailed inside-bearing trucks with roller-bearing axles and metal wheelsets.

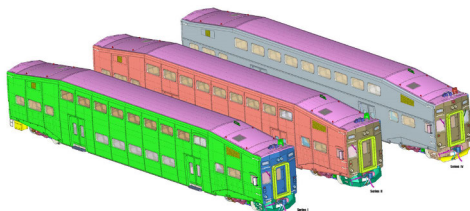

Underbody piping and rigging will get Rapido's usual attention to detail. A minimum track radius of 22" is recommended for reliable operation.



Road Names will be AMT Montreal, GO Transit (Toronto, early design), Metrolink (Los Angeles), Trinity Railway Express (Dallas/Fort Worth), Tri-Rail (Miami), West Coast Express (Vancouver), and undecorated.



Rapido has also announced plans to produce three versions of the Pennsylvania Railroad's 50' class F30A, F30D, and F30G flat cars. The

HO scale model replicates the one-piece cast steel prototypes introduced in the early 1930s.

Beginning in the mid-1950s many of the workhorse flat cars were rebuilt for early piggyback service. The PRR designated theirs F30D. Modifications included perforated side rub rails, side posts and end loading ramps. In the late 1950s PRR transferred 86 cars to TTX where they received additional upgrades including retrofitting the trucks with roller bearings.

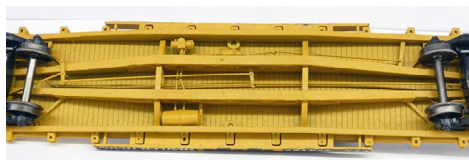

Rapido's models will have full brake rigging, separate grab irons, a die-cast chassis for weight, Kadee couplers, and PRR 2E-F10 trucks with solid

or roller-bearings as appropriate to the era being modeled. Six car numbers will be available for each paint scheme.



Basic F30A 50' flats will be available in original PRR scheme, for 1950 service, and 1960 service. The F30A will

also be available for Penn Central, Lehigh Valley, and in Conrail's MOW scheme.



F30D TOFC car with perforated side rub rails, end loading ramps and four side posts will be available decorated for TTX in both

early and late red schemes, and for PRR.



REGISTER
(free)

[INDEX](#)

[TABLE OF CONTENTS](#)



Rapido's F30G version of the 50' TOFC will feature an ACF trailer hitch, revised side rails, upgraded end ramps and roller-bearing trucks.

The F30G will be available for TTX yellow. All versions will be available undecorated. For additional information contact a dealer or visit www.rapidotrains.com.



Tangent has introduced a new series of HO scale Pullman Standard triple-bay coal hopper cars. Variations include the PS3526/3600 cu. ft. hopper favored by eastern railroads and the PS4000 cu. ft. version

preferred by western roads. To correctly replicate the prototypes, Tangent tooled four dimensionally correct car body variations with both trapezoidal and flat side panels, as well as offset and non-offset truck center arrangements.



Noteworthy details on Tangent's new coal hoppers include scale coupler lift bars, rubber air hoses, car shaker parts, see-through brake platforms, hidden weights, Kadee

couplers, and 100-ton Barber S-2 trucks with machined metal wheels and rotating bearing caps. Each model comes with a removable load.



The PS4000 version of the car is available decorated for Chicago North Western, and in two mid-1970s Burlington Northern schemes.

The PS3526 variant is available for B&O Chessie System. Undecorated models include the PS 3526, and Phase 1, 2, and 3 of the PS4000 cars. For additional details visit

www.tangentscalemodels.com.



Walthers is selling a 67' 6351 cu. ft. quadruple-bay covered hopper decorated for Archer-

Daniels-Midland (Walthers 920-105821). The HO scale Proto series model is available in four ADM road numbers.

Instructions for operating the outlets is stenciled on each of the four discharge bays. Details include etched-metal walkways and end platforms, and 36" machined metal wheels

For additional information contact a dealer or visit www.walthers.com.

N SCALE PRODUCT NEWS



Athearn plans to release an N scale 60' PS auto boxcar next No-

vember. The N scale model is based on a prototype developed by Santa Fe, Pullman Standard, and Ford Motor Company in the mid-1960s (see the side bar in the HO scale report).



Road names for the N scale model will be Chicago,

Burlington & Quincy; Milwaukee Road, Louisville & Nashville, Norfolk & Western, Frisco, and Southern Pacific. The model will ride on 100-ton roller-bearing trucks with metal wheels and an extended drawbar. A minimum track radius of 15" is recommended.



Twelve road numbers will be available for Athearn's N scale F89F flat car which is set for release next November. Six of the cars will be in brown livery,



REGISTER
(free)

[INDEX](#)

[TABLE OF CONTENTS](#)

with the other half in yellow. The models will have positionable hitches, wire grab irons, separately applied brake ratchet, trucks with machined metal wheels, and body mounted knuckle couplers. For additional information contact a dealer or visit www.athearn.com.



Atlas' 2021 3rd quarter N scale production schedule includes an Alco S-4 switch engine with two styles of cabs; riveted or welded.

The new diesel model is based on a 1,000hp prototype the American Locomotive Company introduced in 1950.



The N scale locomotive features fine scale handrails, separately-applied air hoses and uncoupling levers, and directional LED

lighting. In addition to standard DC operation, the model will be available for DCC operation with a factory installed ESU LokSound decoder.



Road names include Baltimore & Ohio, Boston & Maine, CP Rail, Grand Trunk Western, Pennsylvania Railroad, Santa Fe,

Southern Pacific, Boston & Maine, and undecorated.

Did you see this article?



The story of modeling six switchers ...

Get the December eBook now ← click here

In **MRH** **RUNNING**
EXTRA





R. Bale

RBL BOXCARS

RBL is the AAR class designation for an insulated bunkerless refrigerator car with loading devices.

The 50' RBL car General American Corporation introduced in 1960 was revolutionary for its all-welded body construction and the wide variety of load restraining devices available to customers. The cars were designed for transporting goods that needed to be shielded from extreme temperature variations. While initially used to transport canned goods and newsprint, the cars became very popular for shipping beverages and perishables. While not providing actual refrigeration, a pre-refrigerated load could expect to hold its temperature within a few degrees for several days while in transit.



3rd quarter 2021 production schedule.

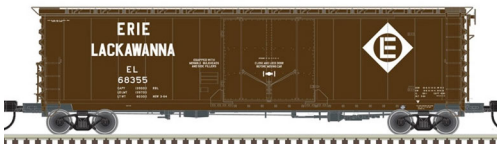
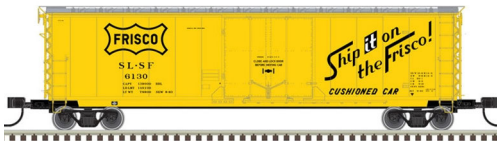

Lackawanna, New York Central, Nickel Plate Road, Rock Island,

Atlas is developing new tooling for an N scale 50' General American RBL boxcar. The finished model will be included in Atlas's

3rd quarter 2021 production schedule. Features on the new N scale model include separately applied wire cut levers, etched metal running boards, and etched metal crossover platforms.

Road names on the initial release will be Missouri Pacific, Delaware & Hudson, Wabash, American Refrigerator Transit, Erie-



REGISTER
(free)

[INDEX](#)

[TABLE OF CONTENTS](#)

and Frisco. An RBL with the running boards removed will be available decorated for Conrail.

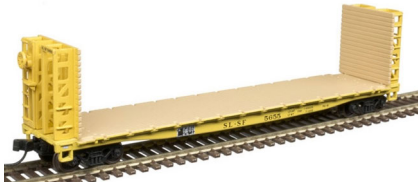

Atlas has included a N scale version of a 48' GSI bulkhead flat car in its 3rd quarter 2021 production schedule.



Road names will be Frisco, Atlantic Coast Line, BC Rail, Burlington, Burlington Northern, Chicago Great

Western, Gulf Mobile & Ohio, Missouri Pacific, and Union Pacific.



Also coming from Atlas next year is this Trinity 31,000 gallon crude oil tank car.

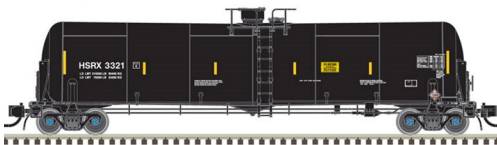

The N scale model will come with BLMA 100-ton ASF Ride-Control trucks fitted with 36" metal wheels. In addition to Ferromex, road

names will be HSRX-High Sierra Energy, and CBTX.



Additional N scale models coming from Atlas include this all new 4180 cu. ft. Airslide covered hopper. Developed in the early

1950s, subsequent production went through several modifications. The new Atlas N scale double-compartment version follows a prototype introduced in 1962.

Road names will be Frisco, Rock Island, Northern Pacific, Santa Fe, Burlington Northern, BNSF (buffer service), Brach's Candy,



Chessie System, SSW-Cotton Belt, Golden West Service, and Western Maryland. Availability is planned for the 3rd

quarter of next year. For additional information contact a dealer or visit www.atlasrr.com.



Con-Cor's N scale 2020 Christmas model is a pair of 53' containers. The switch by Con-Cor to containers for the Christmas model was prompted by inconsistent deliveries from China of some car parts. To

purchase the limited run containers, visit www.con-cor.com.



Fox Valley Models has released three new N scale containers. They are available in 2-packs. Hanjin 20' (89-

1004) and Capital 40' (89-1104) containers both have corrugated sides.



A pair of 48' smooth side (89 1301) containers are available for BN America with one displaying anniversary graphics. For additional information

contact a dealer or visit www.foxvalleymodels.com.



ImagineThatLaserArt has released a craftsman style kit titled Allstate Machine. The N scale laser-cut model can be built in several configurations including as a conventional standing building. As shown here the N scale model has a footprint of 5.75"L x 3.5"W x 3"H.



ITLA's Allstate Machine model can also be built in an elongated format as a shallow background flat. Components in the kit include etched scale brick surfaces on solid MDF wood, and laser-cut windows with two styles of pre-cut glazing. Loading dock

details include distressed wood decking, interior bracing, positionable loading doors, positionable steps, pallets, and crates.



Wall details include fire escapes, ventilation fans, electrical and gas meters, and entry door security bars. HVAC ducting, a chimney, and a vertical stack are included for roof details. Color signs and an instruction booklet complete the model. A separate kit for a 4th and 5th floor extension is available as

an add-on module. For additional information visit www.itlascalemodels.com.



Kato USA is now taking reservations for the Southern

Pacific GS-4 4-8-4 locomotive in "Postwar" black. With a scheduled release of September 2021, the N scale model will

feature large “Southern Pacific” lettering on the tender, differentiating it from the wartime “Southern Pacific Lines” scheme. Kato is announcing this as a provisional pre-order, with a cutoff date of December 30th. At that time Kato will determine if there are enough preorders to continue the project. For additional information contact a dealer or visit www.katousa.com.



A list of new N scale models from **Micro-Trains** begins with this 50' Denver & Rio Grande Western boxcar with a plug door.

The model represents a car built in 1965 that has been updated with the running board removed.



This excess height 60' box car represents a car built in 1968 for high-cube, low-weight appliance service.



Micro-Trains has released two cabooses this month including a 36' conventional steel cupola caboose decorated for Milwaukee Road. The second new caboose is a 31' bay-window based on a prototype class C-27 car built for the Baltimore & Ohio that through mergers wound up on the CSX.



Contact a dealer for additional information on Micro-Trains models.

miniprints now has over 20 different animals and figures available in N scale. Figures include porta-potties and



Sasquatch with animals such as Texas Longhorns, African Elephants, Pigs, Donkeys, Bison, and Candian Geese also available. Visit miniprints.ca/#nscale

for a list of what is currently available.



RailSmith has been working on an all-new N scale coach/chair car accurately modeled to Pullman-Standard

plan 7510. Both skirted and non-skirted versions are being tooled. Details include sprung diaphragms, working knuckle couplers, metal wheels, and electrical pick-up. The first release, scheduled for January, will offer accurate paint schemes for Northern Pacific, Great Northern, and Spokane, Portland & Seattle. Although not dead accurate, cars decorated for Union Pacific and Southern Pacific will be very close to the prototype. For additional information visit lowellsmith.net/railsmith.



ScaleTrains.Com is booking advance reservations for an Operator series GE ES44

Tier 4 GEVo diesel locomotive.



The Operator series models use the same motor and drivetrain as the top-of-the-line Rivet

Counter versions, however, to achieve a low selling price on Operator models, cosmetic variations within each road name are kept to a minimum. Accordingly, all ES44 locomotives in this run will use the same cab and long hood.



Road names on this run will be Kansas City Southern (Belle scheme), Norfolk Southern (Horsehead), CSX (boxcar logo), Canadian National (wet noodle with website), and BNSF (Heritage III).

For hobbyists wanting to upgrade their Operator model, an ES44 detail kit with nearly 100 individual parts is available as a separate purchase.

Traditionally ScaleTrains.com has announced new locomotive models at TrainFest. While TrainFest

may not have occurred this year, ScaleTrains.com announced that they are taking pre-orders Norfolk Southern's unique GE Dash 9-40C "Top Hat" locomotive in N scale in the Rivet Counter line. Alone of the Dash 9 line to be built with standard cabs and a prime mover derated to 4000hp, Norfolk Southern purchased 125 C40-9s in 1995. Numbers 8764 through 8888, they were delivered in the Thoroughbred paint scheme. A rebuilding program between 2015 and 2018 converted the Top Hats to AC, upgrading their prime movers to 4,400 hp, and replacing the cab with a wide cab. The rebuilt units are designated as AC44C6Ms.





Additionally, pre-orders are being taken for Rivet Counter BNSF

Heritage II Dash-9s with road number and era specific details, including two road numbers with Heritage I painted engine cabs, two with faded orange replacement HVAC units, and one unit with an ex-Conrail Quality nose door. For additional information visit www.scaletrains.com.

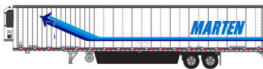

Trainworx has announced it is taking reservations for an assortment of modern over-the-road trucks in 1:160 scale. Company names

include CR England, JB Hunt, Marten, Schneider National (two eras), Swift, Swift Refrigerated, Walmart and Werner. Several model and paint variations will be available for each name. Reservations are due by December 31, 2020 with delivery expected in the 3rd Quarter of 2021. To see detailed flyers on all of the offerings, go to mailchi.mp/9050488d2213/trainworx-news-12967290.

NEW DECALS, SIGNS AND FINISHING PRODUCTS



Great Decals has HO scale lettering sets for Southern Railway early cupola and bay window cabooses. The dulux gold decals include road names (in both modern sans serif and older serif typefaces), heralds, road numbers, safety heralds,

labels specific to cabooses, and multiple "canned" road numbers. Set #149 was designed by Robert Wingo as a replacement for Champ HC-235.

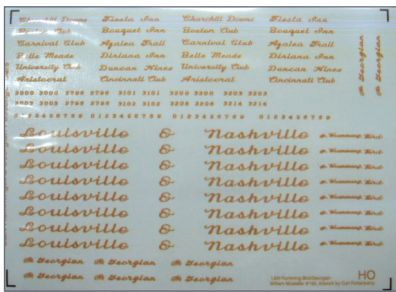

Also available from Great Decals in HO scale is set #150, the L&N Hummingbird/Georgian tavern-lounge and dining car decals in dulux gold. Each set has the letterboard script, numerals, and car names specific to this group of cars. Each sheet can decal up to

four cars, with car names including Churchill Downs, Boston Club, Carnival Club, Belle Meade, University Club, Aristocrat, Fiesta Inn, Bouquet Inn, Azalea Trail, Dixiana Inn, Duncan Hines, and Cincinnati Club. For additional information visit www.greatdecals.com.

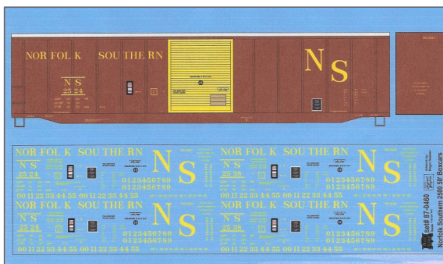

Mask Island has released several new waterslide lettering sets including a 1973-era Norfolk Southern 50' boxcar. Also new is a decal lettering set for Southern Railway hopper cars modified for extra loading.

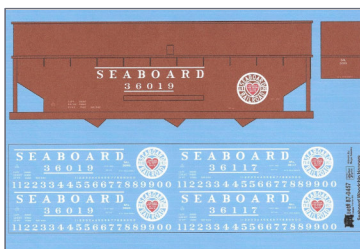
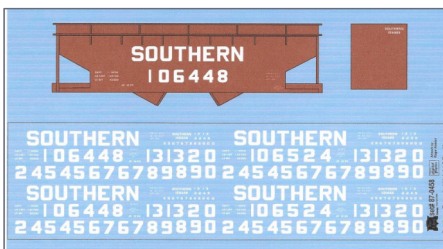

Lettering sets for Seaboard extended height hopper cars and a Missouri Pacific 50' double-door boxcar have also been recently made available.

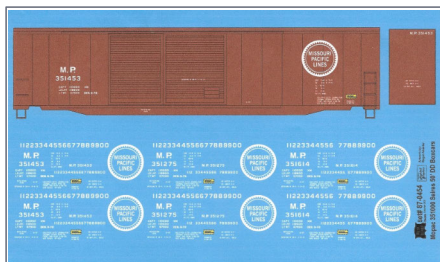

Additional new Mask Island lettering sets are available for decorating 40' and 50' Rock Island DF cars, and a Houston Belt Terminal switch engine. All sets mentioned are for HO scale. For additional details visit www.maskislanddecals.com.

★★★★★
RATE THIS ARTICLE

DISCLAIMER

The opinions expressed in this column are those of the writer and do not necessarily reflect the opinion of Model Railroad Hobbyist or its sponsors. Every effort is made to provide our readers with accurate and responsible news and information, however, neither Model Railroad Hobbyist or the writer of this column can be held responsible for any inaccuracies or typographical errors that may inadvertently appear in this column.

Did you see this article?



**A great workbench tool:
the Ultimition sander**

Get the December eBook now

← click here

In

MRH

RUNNING
 #####
 EXTRA

 **BRIEFLY NOTED AT PRESS TIME ...**

Digitrax has released the UT6 utility throttle, featuring a color 1.5" LCD display screen and backlit buttons. Available as the UT6 wired, the UT6D Duplex Radio, and the UT6DE Duplex Radio (Europe) versions, it replaces the UT4 series. digitrax.com.

FastTracks has introduced "The Diamond Line," a series of cast diamond crossing kits. Available first in HO scale, the kits will include individual frog and guard rail castings, precision cut laser cut ties, PC board ties, rail for the crossing, four sanding blocks in two grits, and a wire brush. handlaidtrack.com.

Morning Sun Books has released *Norfolk Southern – Southern Railway Merger* in which author Kurt Reisweber presents a mid-1970s look at two of America's most storied railroads. Details are available at morningsunbooks.com.

National Scale Car has reissued resin mini kits to create prototypically accurate 1937 AAR boxcars with Duryea Z26 underframes for Rock Island and Chicago, St. Paul, Minneapolis & Omaha Railways. For each mini-kit the modeler must supply an InterMountain 10'6" IH 40' boxcar kit with 5-5 ends. For additional information visit nationalscalecar.com.

Woodland Scenics has released a video that demonstrates how to develop realistic landscapes with fine turf scenery. The video can be viewed at:

woodlandscenics.com/show/video/FineTurfProduct/?utm_source=scenicview202011&utm_medium=email&utm_campaign=scenicview202011. ■



RATE THIS ARTICLE



REGISTER
(free)

[INDEX](#)

[TABLE OF CONTENTS](#)

SELECTED EVENTS



Model Railroad Hobbyist | December 2020

DECEMBER 2020

Due to COVID-19 restrictions, please check with any organization hosting an in-person event for the latest status of the event.

Ongoing

ONLINE, Zoom, dates vary, see website. Operation Special Interest Group Meetups – limited attendance available. For more information visit www.opsig.org/Virtual. Past meets are available online at www.opsig.org/Virtual/Past.

ONLINE, Zoom & YouTube, dates vary, see Facebook page. “New Tracks” Meetup, hosted by Jim Kellow, MMR. See www.facebook.com/groups/544983829687669/user/100012440913008 for more information.

ONLINE, Facebook & YouTube, dates vary, see Facebook page. “NMRax” organized by Gordy Robinson, Martyn Jenkins, Gert Muller, Jordan Kramer. See www.facebook.com/groups/nmragroup for announcements.

ONLINE, YouTube, every other Saturday. 4th Division, Pacific Northwest Region, NMRA hosts online layout tours and clinics. Archive available at www.youtube.com/c/4DPNRMovies.

ONLINE, Zoom, Second Tuesdays, 8pm EST. "Off the Beaten Track" featuring Narrow Gauge layouts and manufacturers. For more information visit groups.io/g/NNG December 2020, by location.

ONLINE, Facebook, December 1st 8:30pm – 9:30pm PST, Understanding Railroad Signals. Hosted by the Sacramento Model Railroad Historical Society and Mike Roqué. For more information go to www.facebook.com/events/145197060635888.

ONLINE, Zoom, December 5, Hindsight 20/20 5.0 – A Virtual RPM. Registration required. For more information and to register go to speedwitchmedia.com/product/hindsight-20-20-5-0-registration.

MICHIGAN, BLISSFIELD, December 12th, 19th. Blissfield Model Railroad Club Holiday Tour. Hosted by the Blissfield Model Railroad Club. 109 E Adrian St. For more information visit www.facebook.com/events/363704138055106.

PENNSYLVANIA, ROCHESTER, December 5-6, 12-13, 19-20, 26-27, 5th Annual Holiday Model Railroad Open House, 350 Adams St. Five different displays in five different scales. For more information see www.facebook.com/events/629161987779721.

January 2021

ONLINE, Zoom, January 9th, Hindsight 20/20 6.0 – A Virtual RPM. Registration required and will open approximately 2 weeks prior to the event. For more information visit speedwitchmedia.com at that time.

ONLINE, Zoom and Slack, January 30-31. 2021 Bay Area Virtual PCR/LDSIG Meet. Sponsored by the Pacific Coast Region NMRA and the Layout Design SIG. Clinics, Layout ops consultations, track planning consultations, virtual layout visits. For more information visit www.pcrnmra.org/sigs/index2021DEV.html.



REGISTER
(free)

[INDEX](#)

[TABLE OF CONTENTS](#)

Future 2021-2022

CALIFORNIA, SANTA CLARA, July 4-11, 2021, Rails By the Bay, 2021 NMRA National Convention and National Train Show. Santa Clara Marriott Hotel. For more information visit <https://www.nmra2021.com/>

CONNECTICUT, WEST SPRINGFIELD, Cancelled – 2021 Railroad Hobby Show. For more information visit www.railroadhobbyshow.com.

TEXAS, PLANO, January 16-17, Dallas Area Train Show, hosted by the North Texas Council of Railroad Clubs, Plano Event Center, 2000 E. Spring Creek Pkwy. For more information see dfwtrainshows.com/#clients.

INDIANA, NOBELSVILLE, January 31, Noblesville Train Show, presented by the Central Indiana Division of the NMRA. 2003 Pleasant Street. For more information visit www.cidnmra.org/services.

INDIANA, FRANKLIN, May 15, Franklin Train Show, presented by the Central Indiana Division of the NMRA. Johnson County Fairgrounds. For more information visit www.cidnmra.org/services.

MISSOURI, St. LOUIS, tentatively September 2022, NMRA National Convention and National Train Show. ■



RATE THIS ARTICLE

Tell your friends what they're missing by not being an MRH magazine reader!

F30 FRENZY



**TRAILERS
AVAILABLE
SEPARATELY!**

HAND PAINTED PRE-PRODUCTION SAMPLES

CLICK HERE



REGISTER
(free)

[INDEX](#)

[TABLE OF CONTENTS](#)

CLICKABLE ADVERTISER INDEX

[Accu-Lites](#)
[Amherst Railway Soc RR Hobby Show](#)
[Archer Fine Transfers](#)
[Atlas Model Railroad Co.](#)
[Bachmann](#)
[Berrett Hill Trains](#)
[Black Cat Publishing](#)
[Blair Line](#)
[Canyon Creek Scenics](#)
[CG Model Trains](#)
[Coffman Graphics](#)
[Crew Call with Mike Rose](#)
[Digitrax \(2 page spread\)](#)
[East Coast Circuits](#)
[El Dorado 3rd PlanIt](#)
[ESU LokSound](#)
[Fast Tracks](#)
[Great Decals](#)
[Humancity Junction](#)
[Inter-Action Hobbies](#)
[Iowa Scaled Engineering](#)
[Litchfield Station](#)
[Logic Rail Technologies](#)
[Micro-Trains Line](#)
[Mike Rose Hobbies](#)
[Miniprints.ca](#)
[Model Railroad Control Systems](#)
[Model Rectifier Corporation](#)
[Model Train Technology](#)
[Monashee Laser Engineering](#)
[Monroe Models](#)
[Mountain Subdivision Hobbies](#)
[MRH Store \(1\)](#)
[MRH Store \(2\)](#)
[MRH Store \(3\)](#)
[Mt. Albert Scale Lumber](#)
[NCE \(2 page spread\)](#)
[North American Railcars \(PWRS\)](#)

[Pre-Size Model Specialities](#)
[Precision Design Co.](#)
[Rails by the Bay](#)
[Rapido \(1\)](#)
[Rapido \(2\)](#)
[Ring Engineering \(1\)](#)
[Ring Engineering \(2\)](#)
[Roomettes](#)
[ScaleTrains.com](#)
[SoundTraxx](#)
[Southern Digital](#)
[Streamlined Backshop Services](#)
[The Trainmaster Inc](#)
[TrainMasters TV](#)
[Tam Valley Depot](#)
[24 Trains.tv](#)
[Walthers](#)
[Westerfield Models](#)
[Woodland Scenics](#)

Did you see this article?



**Prepping cars for
layout operation**

In **MRH** **RUNNING**
EXTRA

Get the December eBook now

click here

Clickable "other" index

[Other – Contents](#)

[Other – Cover](#)

[Other – MRH Marketplace](#)

[Other – MRH Sponsors](#)

Coming next month in MRH ...

Our ops for the rest of us series continues with two layout examples ...

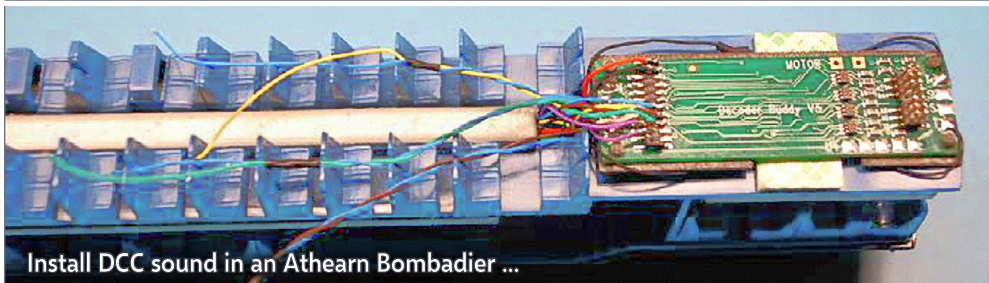

Install DCC sound in an Athearn Bombadier ...

HAVING FUN WITH TRAINS
JANUARY 2021 | FREE

MRH

MODEL RAILROAD HOBBYIST

Two layouts made for ops
Simple, fun, realistic ▶ [READ NOW](#)

ADAPTIVE EDITION TABLE OF CONTENTS



... coming in the
January MRH



[REGISTER](#)
(free)

[INDEX](#)

[TABLE OF CONTENTS](#)

Coming next month in Running Extra ...

... all the MRH articles and ads, PLUS:

Model this UP Relco maintenance-of-way train ...



All about early New York Central steamer modeling options ...

January 2021 - \$2.99

MRH **RUNNING**
EXTRA
Apprentice with savvy modelers

Model this
UP Relco MOW train
▶ **READ NOW**



Also these articles:

- Lorem ipsum dolor sit amet
- Consectetur adipiscing elit morbi
- Vestibulum tempus vehicula
- Mauris tempor libero ipsum pellentesque
- Nullam porta ut arcu at lobortis
- ... and much more!

Rey Breyer on using stock cars to haul other things ...



... all this and much more!

RE SUBSCRIBE 1YR \$19.99