

HAVING FUN WITH TRAINS

FEBRUARY 2019 | FREE

MRH

MODEL RAILROAD HOBBYIST

ALSO:

- Basement-filling HO_n3 layout
- Passenger car lighting enhancements
- SP&S first run RS-3
- Finding answers on the MRH forum

... and more inside!



Rob Spangler on

Modeling running water

▶ READ NOW

PORTRAIT EDITION



DOWNLOAD



REGISTER
(free)

Now Available from



N SCALE 1973 FORD® F-100 PICKUP TRUCKS

After hitting record production numbers with the 1972 F-100, 1973 kicked off the 6th Generation of Ford F-Series pickups. In addition to introducing a longer wheelbase compared to previous models, these larger "new generation" trucks featured roomier cabs and were advertised as the most "comfortable and carlike of any conventional pickup ever built" by Ford. In calendar year 1973, 429,664 F-100s were produced in plants across the United States, Mexico, Canada and Argentina. "Pickup" a few of these to increase the traffic on your layout!



RAVEN BLACK



SEQUOIA BROWN



CANDYAPPLE RED/ WIMBLEDON WHITE



WIMBLEDON WHITE



MOW YELLOW



WIMBLEDON WHITE/WINTER GREEN

FEATURES:

- Side view mirrors
- Headlight glazing
- Interior detail
- Under carriage detail
- Moveable tailgate hatch
- Two trucks per pack



FORD TRADEMARKS AND TRADE DRESS USED UNDER
LICENSE TO ATLAS MODEL RAILROAD CO., INC.

CLICK HERE!

FOR MORE INFORMATION OR TO LOCATE A DEALER, PLEASE VISIT WWW.ATLASRR.COM
ATLAS MODEL RAILROAD CO., INC. • 378 Florence Ave., Hillside, NJ 07205

STAFF

HAVING FUN WITH TRAINS

MRH
MODEL RAILROAD HOBBYIST

Model Railroad Hobbyist February 2019 | #108

(Updated 02/01/19)



ISSN 2152-7423

Editorial Staff



Joe D. Fugate, Publisher and Editor



Patty Fugate, Pasteup and Layout



Richard Bale, News and events



Jeff Shultz, News and events, Tech Assistant



Joe Brugger, Copy Editing



Mike Dodd, Copy Editing

Advertising

Les Halmos, Account Manager

Jean-François Delisle, Marketing Assistant

Columnists

Larry Smith, Narrow Gauge/Shortlines

Jim Six, Limited Modeler column

Ken Patterson, Reporter at large

Rotating Columnists

Jack Burgess, Getting Real column

Nick Muff, Getting Real column

Mike Rose, Getting Real column

Tony Thompson, Getting Real column

Rob Clark, Imagineering

Dave Meek, Imagineering

Ray Dunakin, Imagineering

Issue password: Feb2019

Published for the glory of God. [What's this?](#)

MRH SPONSORS



Model Railroad Hobbyist | February 2019 | #108

A - F



acculites.com



railroadhobbyshow.com



archertransfers.com



athearn.com



www.atlasrr.com



bachmantrains.com



backdropjunction.com

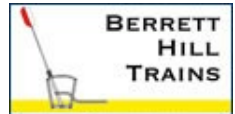

berrethill.com/trains



blairline.com



bowser-trains.com



mycaboose.com



coffmaneng.com



[youtube channel](https://www.youtube.com/channel/UC...)



www.digitrax.com



decalprof.com



trackplanning.com



roometteslighting.com



esu.eu/en



handlaidtrack.com

[Vendors: Get your clickable logo here ...](#)

MRH SPONSORS | 2

G - Z



iascaled.com



lights4models.com



litchfieldstation.com



micro-trains.com



store.mrhmag.com



modeltechstudios.com



handlaidtrack.com/mt-albert-scale-lumber



ncedcc.com



nwhs.org



www.pwrs.ca/main.php



rapidotrains.com



ringengineering.com



scaletrains.com



soundtraxx.com



sodiqi.com



sbs4dcc.com



tamvalleydepot.com



trainteklc.com



walters.com



yankeedabbler.com

Looking for something? Check the MRH Marketplace!

MRH MARKETPLACE | 2

- MAIN STREET AMERICA HISTORIC ARCHITECTURE**
- LOOKING FOR A NEW HOME?** (Click HERE to learn more)
- CPR Station Signs** in 5 different sizes, metal trees with decal lettering
- MAIN STREET AMERICA** (Click HERE to learn more)
- HOBBY MARKETPLACE ads are economical and effective.** Click HERE to learn more.
- SNOW FLYER PRODUCTS**
- Yarmouth Model Works**
- NO DIESEL SUPPLY**
- MasterpieceModules.com**
- Happy New Year! From MRH MCG!**

MRHMAG.COM REGISTER INDEX TABLE OF CONTENTS

Take me there!



Publisher's Musings: Bad weathering & solving problems

JOE FUGATE



Yes, it's a model

from the MRH STAFF



HO

Modeling water on the WP 8th Subdivision

ROB SPANGLER

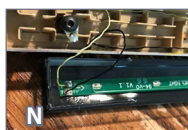

N

Passenger car lighting enhancements

LOU ANGELOCCI



N

First Look: Decals for modeling an SP&S RS-3

The MRH STAFF



ALL SCALES

What's Neat: Basement-filling HO on 3 layout, ...

KEN PATTERSON



MRH QAT: Using an air eraser ...

Compiled by JOE BRUGGER



February 2019 news and events

RICHARD BALE and JEFF SHULTZ



Derailements

Compiled by the MRH STAFF

In

MRH**RUNNING
EXTRA**

This month ...



Buy Issue: \$1.99 >>

store.mrhmag.com

TABLE OF CONTENTS | RUNNING EXTRA

February 2019

★★★★★
RATE THIS ISSUE*More content than what ads will pay for ...***RUNNING
EXTRA**Publisher's Welcome: Getting started with PanPastels
JOE FUGATE

ALL SCALES

Limited Modeler: Staying motivated

JIM SIX



ALL SCALES

Getting Real: Developing a realistic loco fleet

TONY THOMPSON



HO

Chopping the nose on an MLW RS-10

PASCAL LATULIPPE



ALL SCALES

More accurate pipe loads

LEW PHELPS



HO

Building a resin reefer

BILL GILL

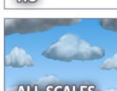

ALL SCALES

Ah-Hah Moment: More realistic painted clouds

JOE FUGATE

"TIERS" FROM HEAVEN

With railroad and road number specific accuracy, lighting effects, and prototypical sound, our HO Scale Tier 4 GEVo locomotives are truly "Tiers" from heaven.

(Actual Model Shown)

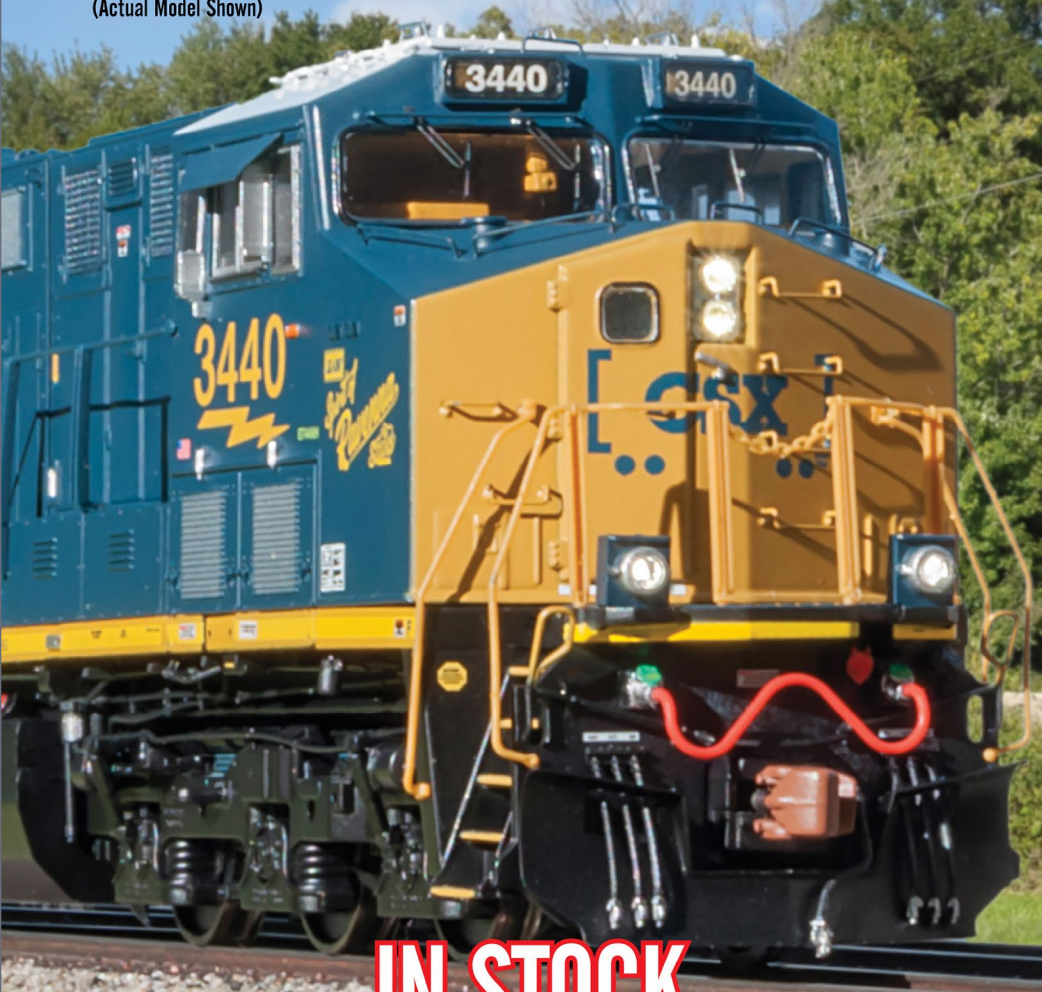

IN STOCK

Order Now

This product is made under trademark license from General Electric (GE).

© 2019 ScaleTrains.com, Inc. ScaleTrains.com, Rivet Counter, and respective logos are trademarks of ScaleTrains.com, Inc.

ScaleTrains.com, Inc. 7598 Highway 411 Benton, TN 37307
844-9TRAINS 844-987-2467 International 423-299-3689

Scene and photography
by Ken J Johnson
Production model shown



HO
#87 SCALE

PUBLISHER'S MUSINGS

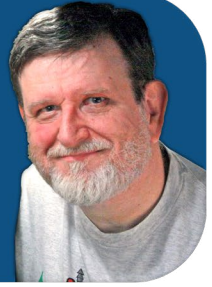

Model Railroad Hobbyist | February 2019 | #108

JOE FUGATE: A BAD WEATHERING JOB AND A GREAT RESOURCE FOR SOLVING THORNY HOBBY PROBLEMS!



RATE THIS ARTICLE

RECENTLY I WAS REVIEWING SOME ONLINE COMMENTS saying a modeler's "weathering job" didn't look very good. I thought the weathering looked pretty good, actually.

The modeler used a reference photo, which is one big point in their favor. Fantasy weathering is almost always poorly done unless you really know what you're doing.

In comparing the model's weathering to the photo, the model's weathering was heavier. But it wasn't that much heavier, just a slight bit heavier. Looked fine to me, even if it was a little heavier.

My point about reference photos is a very important one, but I find more than a few modelers don't weather from reference photos. That's a shame too, when in the Internet Age, a quick Google search often can get you a plethora of photos to pick from.

Even if you're modeling a bygone period or a prototype that doesn't have many if any photos online, weathering is weathering. Just find something representative and adapt it to your model.

Speaking of bad weathering jobs and reference photos, what do you think of this reference photo [1] I found of an SP bay window caboose?

T. McAdams Photo
SP 1764 C-40-7



1. Look at how poor this paint and decaling job is! They didn't even bother covering up the decal film. *Prototype photo by T. McAdams* [espee.railfan.net/nonindex/caboose_photos/1764_sp-c-40-7-caboose-thom_mcadams.jpg]

ADVERTISEMENT

DODX FLAT CAR 3-PACKS WITH HUMVEES

NEW INJECTION-MOLDED MULTI-PIECE HUMVEE WITH ETCHED-METAL DETAILS!

EACH PACK INCLUDES
3 FLAT CARS WITH 9 HUMVEES!

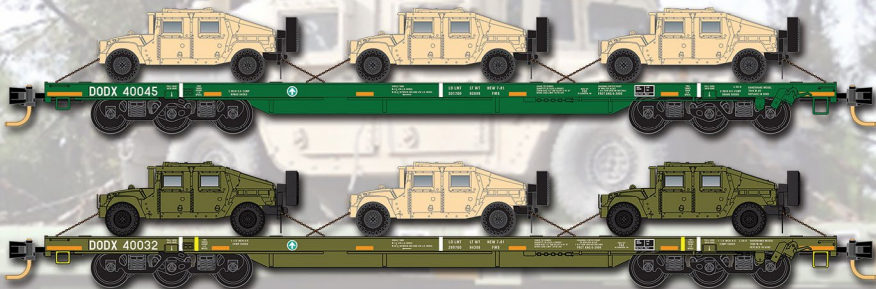

**MICRO-
TRAINS®
LINE**

CLICK HERE FOR MORE INFO

N
SCALE 1:160

MRHMAG.COM

[INDEX](#)

[TABLE OF CONTENTS](#)

HO
SCALE



BACHMANN'S EXCLUSIVE TEST WEIGHT CAR REALLY MEASURES UP

Test Weight Cars had known weights so track scales could be precisely calibrated. Vital for ensuring accurate railroad operations, the scales were used to check axle load limits and to determine the billing of customers for cargo loads. Bachmann's exclusive HO model features a die-cast body, prototypical graphics, metal wheels, and *E-Z Mate*® Mark II couplers. Offered in four popular roadnames, there is also a Painted, Unlettered - Black version that comes with customizable detail parts. Visit your favorite hobby dealer to see how this new Test Weight Car measures up for your railroad operations.



BALTIMORE & OHIO®
Item No. 74401

NEW



BURLINGTON NORTHERN
Item No. 74402

NEW



CANADIAN NATIONAL
Item No. 74403

NEW



UNION PACIFIC®
Item No. 74404

NEW



Click to
learn more



NEW

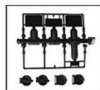

PAINTED UNLETTERED - BLACK
(with customizable detail parts)
Item No. 74405



SHIPPING NOW!
MSRP \$39.00 each



Bachmann Industries, Inc. • 1400 East Erie Avenue • Philadelphia, PA 19124 USA • www.bachmanntrains.com

Click for more information.

MRHMAG.COM

[INDEX](#)

[TABLE OF CONTENTS](#)

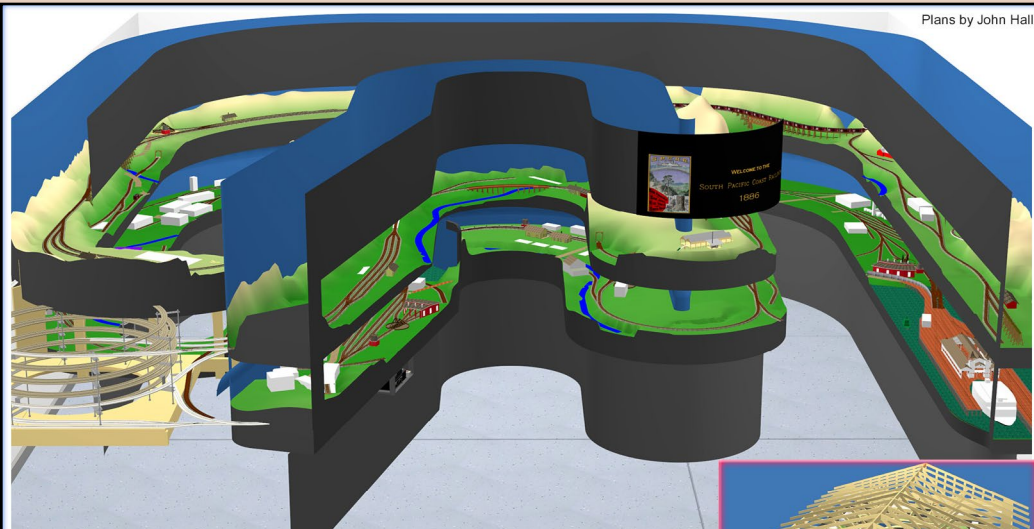

How will you plan your layout?

3rd Plant 3D CAD
The ultimate track planning software

El Dorado
SOFTWARE



PUBLISHER'S MUSINGS | 3

Do you see how this prototype looks like a bad decal finishing job? That's why you need reference photos!

If a modeler was to duplicate this prototype finish on a model, they would be chided for having a poor model finish, yet the prototype photo proves it's completely accurate.

Resource for solving thorny hobby problems

Last month, I was on the road doing layout stories. At one of the layouts, the wonderful steamer with sound and lights suddenly went dead and refused to respond to the throttle.

Now I had a problem. I had been videoing a sequence of runbys with this loco and it had gone totally non-responsive on us. What to do!



THERE'S A WALTHERS CORNERSTONE KIT FOR EVERY HO & N SCALE LAYOUT

MORE THAN 400 KITS CURRENTLY AVAILABLE, AND MORE ON THE WAY!

Designed for easy construction, every kit features detailed plastic parts plus illustrated, step-by-step instructions. Many also include extra parts for easy customizing.

INDUSTRIAL



N Central Beverage Distributors

COMMERCIAL



HO Modern Shopping Center I

RESIDENTIAL

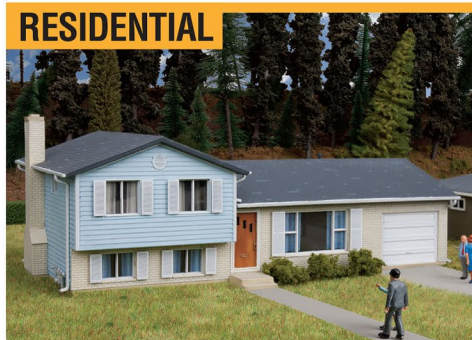

HO Split Level House

RAILROAD

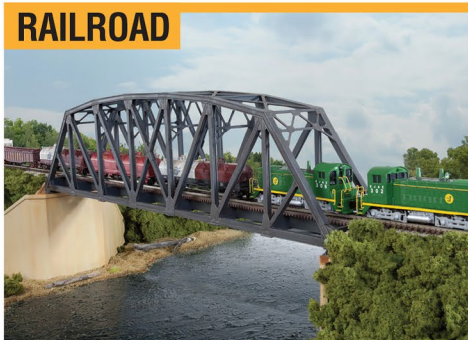

N Single-Track Arched Pratt Truss Bridge

CLICK HERE TO SEE THE ENTIRE CORNERSTONE LINE!

WALTHERS

Support your local hobby shop • visit walters.com • call 1-800-4-TRAINS

©2019 Wm. K. Walther's, Inc.

MRHMAG.COM

[INDEX](#)

[TABLE OF CONTENTS](#)

This layout used DCC, so I asked the layout owner if he as familiar with JMRI (Java Model Railroad Interface), because JMRI lets you quickly look at decoder settings and debug them.

He said yes, so he set up his laptop and fired up JMRI. We spent 15 minutes or so looking at the settings, and tried changing a few settings but nothing was working.

The owner threw up his hands and finally announced he was stumped. He asked me if I had any ideas.

I thought for a moment, then said, “Let’s search the *MRH* forum and see if anyone has had this problem, and what they did to solve it.”

This loco used a Tsunami2 SoundTraxx decoder. I’ve seen other brands of decoder go non-responsive as well, so this is no indictment of SoundTraxx. Happens to the best of them, you could say.

So I use the searchbox in the upper right on the *MRH* website page [2], and typed **soundtraxx quit** into the search box.

Immediately in the first search result entry [3], this came up: *New Tsunami2 stopped working... help?*

As I scrolled down through the posts, I quickly found this one [4]:

“If you confirm that the decoder is powered. try doing a reset on the main. Set CV8 = 8. Cycle the power off for at least 1-2 minutes, (I would personally remove the locomotive from the track), then power the

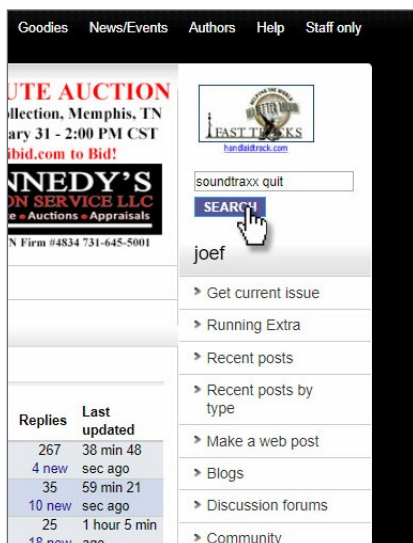

The screenshot shows the top navigation bar of the MRH website with links for Goodies, News/Events, Authors, Help, and Staff only. Below the navigation is a search bar containing the text "soundtraxx quit" and a blue "SEARCH" button with a hand cursor icon. To the left of the search bar are several advertisements, including one for "LIVE AUCTION" and another for "KENEDY'S ON SERVICE LLC". Below the search bar, the search results are displayed, showing a result for "joef" with a list of navigation options: "Get current issue", "Running Extra", "Recent posts", "Recent posts by type", "Make a web post", "Blogs", "Discussion forums", and "Community".

Replies	Last updated
267	38 min 48
4 new	sec ago
35	59 min 21
10 new	sec ago
25	1 hour 5 min
18 new	ago

2. To solve a problem I encountered on a layout visit, I searched for a solution to “soundtraxx quit.”



DCC-Ready ATHG41410 \$249.98

DCC+Sound ATHG04141 \$339.98

LEGENDARY LOCOMOTIVES

RAILFAN FAVORITES RECREATED FOR YOUR LAYOUT

An introduction of interesting paint schemes came from both the Norfolk Southern and Union Pacific during the early and mid 2000s. These colorful and unique locomotives have been seen from coast to coast in a variety of service. Athearn™ brings these Legendary Locomotives to you, in HO scale as Genesis™.



IN STORES!

SPIRIT OF UNION PACIFIC FEATURES:

- 2nd Run!
- PTC antenna array roof
- Headlights and ditchlights lit with LEDs
- Late handrails

Without Sound

ATHG19430 \$249.98

With Sound

ATHG01943 \$339.98



IN STORES!

NS 6920 FEATURES:

- 4000 gallon rebuilt fuel tank
- Cab mounted PTC antenna array
- NS designed snow plow
- Slotted style blower duct kick plate
- Prototypical cab panel louver arrangement

Without Sound

ATHG65204 \$249.98

With Sound

ATHG65254 \$339.98



2nd Run!

NS 9-1-1 FEATURES:

- 3900 gallon EMD fuel tank
- Cab mounted PTC antenna array
- NS designed snow plow
- Horse head style blower duct kick plate
- Prototypical cab panel louver arrangement

Without Sound

ATHG65200 \$249.98

With Sound

ATHG65250 \$339.98

ATHEARN.COM FOR MORE INFO

Equipped with
LED Lighting

VISIT
Your Local Retailer

CLICK
Athemn.com

CALL
1.800.338.4639

SERIOUS FUN!

©2017 Horizon Hobby, LLC. Athearn, Genesis, Ready To Roll, Trains in Miniature, Serious Fun and the Horizon Hobby logo are trademarks or registered trademarks of Horizon Hobby, LLC. The Union Pacific mark and other marks owned by Union Pacific are made under trademark license from Union Pacific Railroad Company. All other trademarks, service marks and logos are property of their respective owners. Final models may vary slightly from photos shown. 60869

MRHMAG.COM
[INDEX](#)
[TABLE OF CONTENTS](#)

track back up with the locomotive on the main. You should get 16 flashes of the headlights (if you suspect the lights are burned out, monitor the red LED indicator on the decoder board.)”

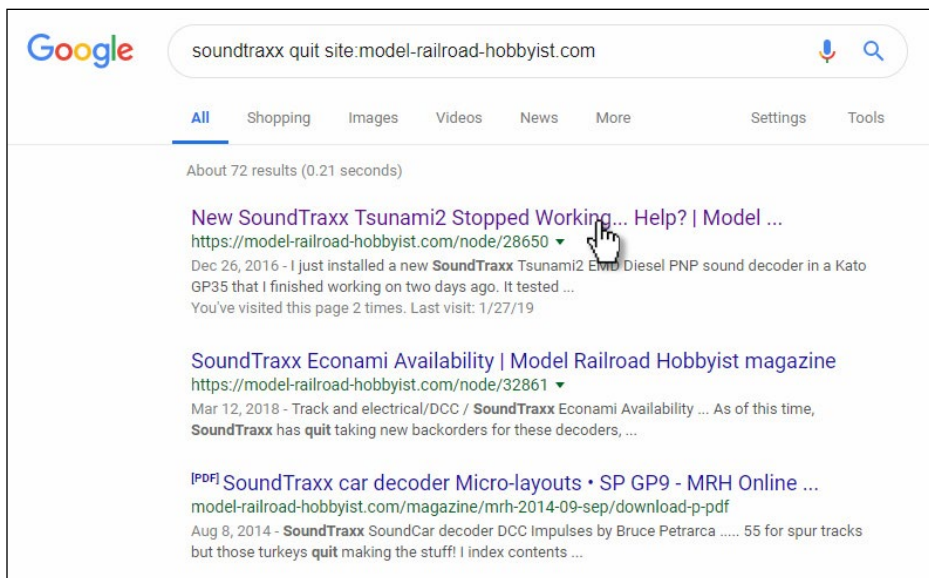

3. The search in [2] returned this result, with the very first entry being most promising. I clicked into the thread and started reading through it.

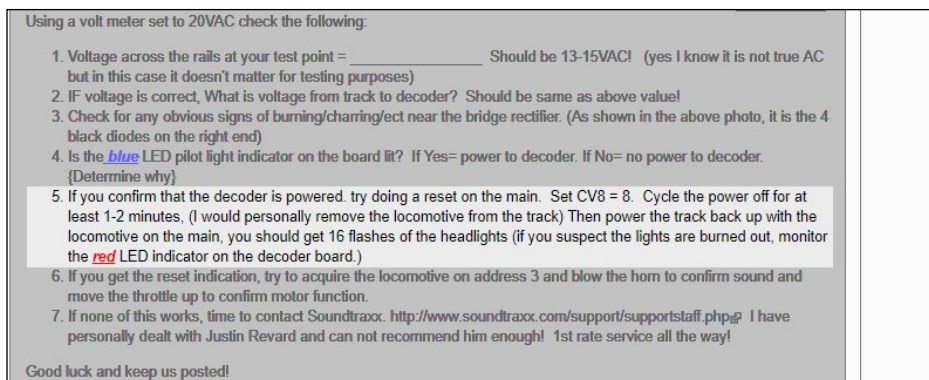

4. Drilling down into the thread in [3] lead to finding this post with a recommended course of action. We followed this and voila – it worked!



THE NEXT CPR LOCOMOTIVE IN OUR
ICONS OF CANADIAN STEAM SERIES

Canadian
Pacific



D10



IN HO SCALE

CPR'S ICONIC "TEN WHEELER"

RAPIDOTRAINS.COM

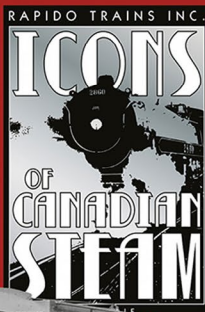

CLICK
HERE



PHOTO COURTESY BRIAN SCHIFF

CABOOSE™

Sharing Our Passion for Trains Since 1938



© 2018 John Harris Photography. All Rights Reserved.

CLICK HERE
for the
**Serious Modeler's
Resource!**

More than 148,721 items,
over 567 manufacturers,
**most at a discount from
full retail – all at
a fair price.**

**As always, in-stock orders of
\$100.00 or more ship free
within the Continental U.S.!***

*surcharges may apply for oversized items.

**10800 West Alameda Ave.
Lakewood, CO 80226
(303) 777-6766**

PUBLISHER'S MUSINGS | 6

So we tried exactly that, following the precise instructions as written, and guess what – it worked! What a relief.

What a great testimony to the wonderful resource the *MRH* forums can be. Hooray, we were back in business again, and I went on to complete the day's video shooting without any further issues.

So if you are having some frustrating issues, don't overlook the *MRH* forum. You will find a lot of great answers there.

If you're not a registered forum member already, you can sign up here (it's free):
mrhmag.com/user/register

Once you get signed up, you can post questions on the forum and get some great answers. We have a lot of very helpful, experienced modelers.

Once you post your question(s) do give it a bit of time. After a day or two, you should start to see some good answers show up.

PWRS 
 PACIFIC WESTERN RAIL SYSTEMS
 SPECIAL RUN CAR

NEW, LIMITED-RUN MICRO-TRAINS CARS

Trinity Rail (TILX) Green Tank Car 4-Pack



CLICK HERE FOR
TILX TANK CARS

AVAILABLE
AUGUST/19

Two different packages,
with 6 or 8 bar reflectors

Green area on top
with reporting marks

Weathered
appearance

Union Pacific (UP ex Rock Island) 3-Bay ACF Hopper Cars 4-Pack

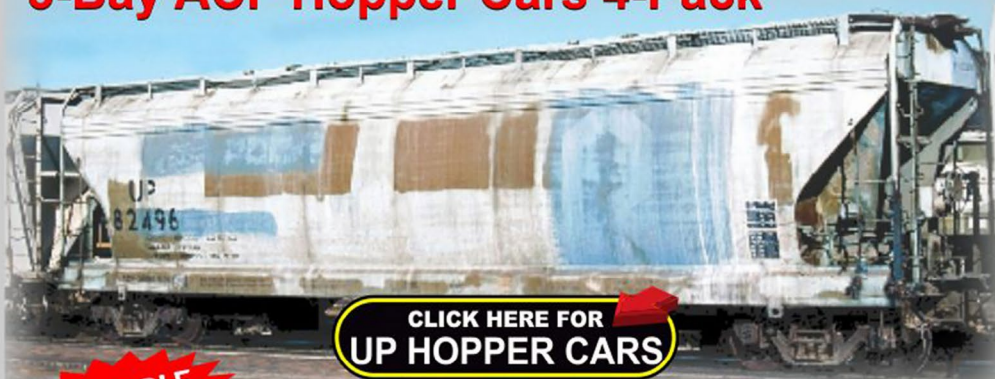

CLICK HERE FOR
UP HOPPER CARS

AVAILABLE
AUGUST/19

Rock Island Blue colour
whitewashed by UP

4 different UP cars
in this series

Weathered,
paint effects

Pacific Western Rail Systems

**LIMITED RUN OF MINIMUM 50 SETS-MADE
EXCLUSIVELY FOR PWRS BY MICRO-TRAINS**

**MICRO-
TRAINS®
LINE**

MRH CONTEST: "California Basement" Challenge

**\$1000 GRAND PRIZE • \$500 FIRST PRIZE
\$250 - Honorable mentions (two chosen)**

**Goal: Design a layout for a one- or two-car garage
(your choice). ENTRY DEADLINE: FEB 28, 2019**

**Two room-size
choices:**

**Single car garage
(14'x24')**

**Double car garage
(24'x24')**

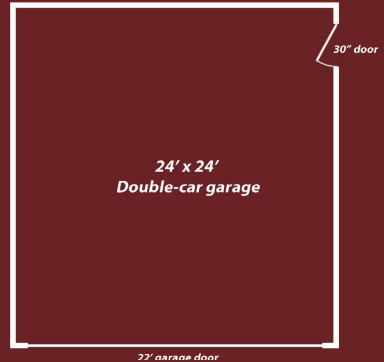
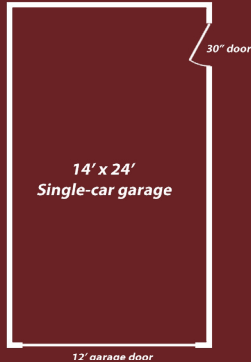

Note: This is a wide open home layout design contest using any design approach. This is not a modular-only contest like past contests.

CONTEST RULES

- Scale: Z-G, standard or narrow gauge.
- Draw up a final track plan and write up the design to be published. Extra points awarded for a high quality track plan, text, illustrations, photos, and captions.
- Describe the layout theme, rationale, and era (if any).
- Outline the basic construction methods you would take if you were to build this design. Extra points awarded for innovative thinking.
- The car does not need to go into the garage. You can use the entire space. However, the garage door does need to remain functional, it cannot be sealed shut, so describe what you will do to deal with that need.
- Beyond that, pretty much anything goes. Have fun and let's come up with some interesting track plans for a garage.
- All submissions must be publishable. If the submission is not formatted to be ready for publication, it will be disqualified. Take the time to be complete, provide captions, and to describe things completely in your text. See the [MRH submission guidelines for more information](#).
- The best submissions will be published and contributors paid for the article.

SUBMIT ENTRY (Choose "Contest entry")

Reminder: Contest entries

Just want to remind you that the clock is ticking toward the deadline for getting your track plan into our layout contest!

On the opposite page, you will find the details of the contest and how to submit your entry. We look forward to seeing your entries and sharing them with your fellow modelers!

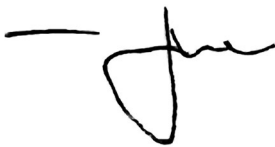

THE Ah-HAH MOMENT
Joe Fugate: More realistic painted backdrop clouds

Buy Issue: \$1.99 >>

In **MRH** **RUNNING**
EXTRA



THE LIMITED MODELER
Jim Six: The secret to staying motivated

Buy Issue: \$1.99 >>

In **MRH** **RUNNING**
EXTRA



LAST ISSUE'S RATINGS

The three top-rated articles in the [January 2019 issue](#) of *Model Railroad Hobbyist* are:

4.8 January 2019 News

4.6 Publishers Musings: Post-Floquil painting answers ...

4.5 Modeling a New York Central K3q Pacific

Issue overall: **3.0**

Please rate the articles! Click the reader comments button on each article and select the star rating you think each article deserves. We depend on these ratings to help us determine which articles to publish, so your rating matters! ■

Get the latest Model Railroading News, Tips, Reviews & Opinions



Our iTunes feed has changed search for
"Mike And Scotty Live" to receive the latest episodes!

www.themodelrailroadpodcast.com

Hosts:

Scott Mason: www.scottymason.com

Mike Rose: www.mrhobby.com

**Don't Miss our Monthly Interviews
& Product Announcements**

Are you being
penny wise and
pound foolish
with your hobby?

The February issue of *Running Extra* has tips that can save you hundreds of dollars and hundreds of hours – and that's just **one** issue!

~350 pages, \$1.99 ea.
1 year sub: \$19.99

All the free MRH content with ads plus another ~150 pages of ad-free in-depth articles and columns.

You can buy and download single issues or get a 12-issue subscription.

**Subscribe to
Running Extra**

[click here](#)



More in-depth articles than ads can pay for ...

Paper mags: 8 cents per page
Running Extra: 1/2 cent per page!



WHAT'S NEW on TMTV!

Oxford County Operations

Mike Confalone's
ALLAGASH

Crew Call

THE BACKSHOP CLINIC

STYRENE FABRICATION

Using styrene to make great models of just about anything.

NOTCH 8

PAN PASTEL WEATHERING

The tricks for getting your rolling stock fleet all weathered in short order.

DCC DECODED

FUNCTION MAPPING DECODERS

Master the intricacies of function-mapping your decoders.

Become a member >>



www.trainmasters.tv



Registered MRH reader? Get your 10% off coupon code here:

Get Subscriber
10% off code

YES ... IT'S A MODEL



Model Railroad Hobbyist | February 2019 | #108

compiled by **JOE FUGATE**



RATE THIS ARTICLE



1. Rick Sutton continues to work on his Visalia Electric layout based on a small short line on the eastern side of the San Joaquin Valley in California. Agriculture makes up the bulk of the work for the VE and here we see the Exeter Cold Storage facility in the distance on a very warm August late afternoon with a reefer that has just been spotted.

► **MRH'S MONTHLY PHOTO ALBUM**

MRHMAG.COM

[INDEX](#)

[TABLE OF CONTENTS](#)



2. A Denver & Rio Grande Western class L97 4-6-6-4 Challenger charred and weathered, pulling a freight train on a high-altitude grade near the summit of the Southgate Mountains on the North American HO scale layout in Milwaukee, Wisconsin.

The locomotive is an Athearn Genesis model that Alan Houtz weathered and painted for his layout. The photo was taken for Trainmasters TV. Mark Mathu took the photo by combining 11 shots taken from different angles and distances and combining them into a single fully focused image using Photoshop.



ges up the stiff westbound
merican Prototype Modelers

ed on an episode of
aken at different focus dis-
licon Focus software.



GET PAID FOR YOUR PHOTO

We pay \$40 per photo we publish. If you would like to get your modeling in our photo feature, just start posting your photos on the *MRH* website, especially in the Weekly Photo Fun thread created each week.

See mrhmag.com/help for more on how to post an image. You need to be an *MRH* subscriber to post photos to our website, and becoming a subscriber is free, [just fill out this form here.](#) ■



UPGRADE YOUR LOCO FLEET

Tony Thompson on getting a more realistic loco fleet

Buy Issue: \$1.99 >>

In **MRH** **RUNNING**
EXTRA



VIEW READER
COMMENTS

MRH MARKETPLACE



MAIN STREET AMERICA HISTORIC ARCHITECTURE



**MAIN STREET
HERITAGE**

www.mainstreet-heritage.com

CLICK
HERE
for all
our HO
& O kits

LOOK
at what's new at
Black Cat this month

Click here for
our website

**Grand Trunk Railway
(CN predecessor)
numbered Passenger
car decals
in Gold Leaf**

Black Cat Publishing
(204)489-5005
ajfergus@mymts.net
blackcatdecals.com



AMERICA'S NUMBER ONE RAILROAD PRINT SOURCE

Jelsma Graphics

...America's Railroad Embroiderer
SERVICE SINCE 1985

HOME OF THE

\$79.95

RAILROAD JACKET

HATS and SHIRTS

www.jelsma.com

CROW RIVER PRODUCTS

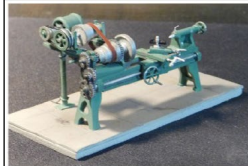

O Scale Kit 335-D
Motor Conversion for Machine Tools
Shown adapted to our 335-A Engine Lathe

Our Machine Tool kits are of the overhead belt type. This kit, allows for attaching an electric motor directly to the machine. The Kit includes a new style electric motor, A base and various pulleys and hardware.
Made in USA \$12.00

HO & O Scale Machinery, Derricks,
Engines, Hardware & Waterfront Models
Pawtucket, RI 02861 Tel 401-723-0065
www.crowriverproducts.com



P.O. Box 6 Paonia, CO 81428

Ph. 970 527 4586

Made in The USA

Cast resin items for All Scales.
Tunnel portals, bridge piers, abutments,
culverts, and retaining walls.
Trackside details and sage brush tree
armatures.

"FREE SHIPPING see website for details"

**HOBBY
MARKETPLACE**
ads are economical
and effective.

Click [HERE](#) to learn more.



LOGIC RAILTM
TECHNOLOGIES

"Sophisticated
Model Railroad
Electronics"



Please visit our website and online store!

21175 Tomball Pkwy
Suite 287
Houston, TX 77070

Phone: (281)251-5813
<http://www.logicrailtech.com>
info@logicrailtech.com

MasterpieceModules.com

T-trak Module Kits & more
CNC machined precision finger joints
parts are self-locating & self-clamping
All hardware is included



Yarmouth Model Works

HO scale resin kits and detail parts

U.S.A. MAILING ADDRESS

2014 Holland Ave Unit 617
Port Huron, MI 48060

Tel. 519-633-7574

pierre.oliver@elgincarsshops.com

www.yarmouthmodelworks.com

CANADIAN MAILING ADDRESS

263 Sunset Dr.

St. Thomas, ON N5R 3C4

ITLA Scale Models Inc.

www.ITLASCALEMODELS.com



Fine Scale Wood Kits

CLICK HERE FOR MORE INFORMATION

www.itlascalemodels.com

HO DIESEL SUPPLY

CUSTOM SOUND LOCO'S-REPAIRS-UPGRADES

Weathered New and Rebuilt Locomotives

Powered Chassis-Trucks-Motors-Handrails-Electronics

Parts Inventory Always Changing

www.hodieselsupply.com

email:gerry@hodieselsupply.com



**HAPPY VALENTINES DAY
FROM MRH MEDIA!**



USRA DS Express Box
NWP Redwood Empire



westerfieldmodels.com

Your ad could be in
this space for as low
as \$88 a month.

Click to learn more ...

MOUNTAIN SUBDIVISION HOBBIES

www.modelrrsupply.com

FREE USA SHIPPING OVER \$39.00

NCE - SOUNDTRAXX - DIGITRAX - ESU LOKSOUND
SPROG - DCC SPECIALTIES - INTERMOUNTAIN - CMX
BAR MILLS - BOWSER - ATLAS - CIRCUITRON - PECO
RIX - PIKESTUFF - CENTRAL VALLEY AND MORE!!!

MONASHEE
LASER
ENGINEERING

COME VISIT
US HERE

MANUFACTURERS OF FINE RAILROAD
STRUCTURES AND ROLLING STOCK MODEL KITS

IF WE CAN DRAW IT ...

PRECISION DESIGN CO.

LASERCUT KITS - CUSTOM DECALS

PDC.CA

Authorized *RailPro* Dealer

FREE SHIPPING in the US and CANADA

Model Railroad Control Systems

Geoff Bunza Project Boards

DCC Occupancy Detectors

CMRInet Compatible Nodes

Layout Telephone Systems

RFID Switchlist Generator

Switch Machines and Drivers

Click Here

Great Decals!TM

FEC, Interstate, Virginian
Railway, & L&N Titles

After Hours Graphics Line
Coupler Gages and More
In O, S, HO, and N Scales



Waiting a
MONTH

just too long?

Check out Ken Patterson's
**WEEKLY VIDEO
PODCAST!**



Watch on



Get your weekly
What's Neat
fix on YouTube!

Check it out >>

*Watch Ken's What's Neat This
Week video podcast on
YouTube each week!*

Norfolk and Western Historical Society



**Looking for N&W or
Virginian models,
books or videos?
Check out the
N&WHS Commissary
for the best selection
anywhere!**



**Researching an N&W or VGN
project? Our Archives
probably has what you need.
We have well over 150,000
items already cataloged with
more added all the time.
Drawings, photos, diagrams
are just a few of the many
items in our collection.
Consider joining for \$45 per
year. You get 4 high quality
magazines and members save
on items from the archive!**

Click Here!

Modeling Water on the 8th Sub



ROB SPANGLER *shows how he modeled
the water in Cedar Creek ...*





RATE THIS ARTICLE

I WANTED A PROJECT OF LIMITED SCOPE THAT

would still provide evidence of progress. Modeling some water sounded like a plan, so I got to work on the Cedar Creek scene from last year's *MRH* Forum Challenge. For construction of this scene before adding the water, see mrhmag.com/node/8540.

Site Prep

The scene was almost ready for water, but there were a few additional tasks to be done.



1. Preparing for the first resin pour.

To help impart some apparent depth to the future stream, I air-brushed Floquil Railroad Tie Brown into the creek bed [1]. I did this while painting some nearby flex track.

Darker colors can give the appearance of deeper water when viewed from above. It's important to avoid hard edges, so an airbrush is ideal.



J. Fugate

ALTERNATIVES TO FLOQUIL

MRH provides a free eBook on new paints you can use in place of Floquil or PollyScale, but you do need to be an MRH registered reader (free) to access: mrhmag.com/subscribers-only/painting/acrylics ... this book is also available from the MRH Store in paperback for \$17 plus shipping. This book also has formulas for matching the Floquil and PollyScale colors with these new paints.

Also, the creek bed slopes somewhat, and the intended water material tends to flow downhill if not restrained. Adding “dams” at the location of future rapids helps to hold the “water” so it doesn't migrate too far downstream before setting. I've tried several ways to do this, but here I used some acrylic gel medium [1]. I have also used clear caulk (Powergrab clear adhesive caulk; other types should work, although I'm not sure I'd trust pure silicone, since later materials may not stick to it well). Acrylic gel medium is pretty much like acrylic caulk to work with in this application, but is more expensive.

Note that so far I've kept most of the vegetation away from the future stream banks until after the water has been added. The reason for that will become obvious later.

First Pour

For water, I used tried -and-true epoxy resin. I've tried several brands that all work interchangeably, including Enviro Tex, Crystal Sheen, and this one, "Amazing Clear Cast." It was the brand available at Hobby Lobby where I had 40%-off coupons handy.

One thing I've done for ensuring epoxy resin sets up is to make sure to use a bit more (like one-half percent more) "part b"/hardener than "part a"/resin. All the instructions seem to say to mix 50/50, but if you look at the containers you'll probably see more in the part b – I'm assuming this isn't an accident.

I've never had a batch fail to set properly with extra hardener. Try for a precise 50/50 mix, and you may find yourself with something that won't set up. I know I did when learning to use this stuff. If temperatures are warm enough (see the directions) and you use extra hardener, every batch should set up perfectly within a couple days. Make sure you reference the note on adding more hardener, however!



R. Spangler

ADDING MORE HARDENER

Subject matter experts on the chemistry of these products advise we can't automatically assume extra hardener should be used with a two-part resin. Only add more hardener if a test batch on some scrap scenery fails to set when mixed per manufacturer recommendations.

For mixing, I used the rigid plastic containers from some Hillshire Farms lunch meat, cleaned in the dishwasher first. Any



2. Here is the first resin pour.

disposable plastic container should work, provided it's tough enough not to melt from heat as the resin in it starts to set. There's just enough heat to affect flimsy plastic.

The track was taped as a precaution [2]. Resin that drips into the ground elsewhere can be readily covered up, but I didn't want any stray drops ruining the track weathering or ballast. Also note the newspapers on the floor to protect the carpet. Resin will find a way to leak through every available hole in your scenery, so take care to cover everything below it. Fortunately I had no leaks.

Since I wanted the creek to look greenish and somewhat muddy, I added some Testors Olive Drab enamel military paint. A few drops are plenty. Clear resin is rarely realistic, so look at

prototype photos for examples of color. Other Testors paints of use include Dark Tan and Dark Green, and Floquil Pullman Green works great for other parts of my region.

I taped off the ends of the water course, then backed up the tape with some Homasote scraps clamped in place [3]. Homasote is soft enough to deform over irregularities in the fascia and prevent stray resin from going anywhere.

If you get resin on the carpet or your clothes, Goo Gone will take it out as long as the resin hasn't cured.

Second Pour

I allowed the initial batch of resin to set up for about three days before applying the next. I mixed both batches the same, including



3. This is the opposite end of the watercourse scene.



4. Upstream end of the second pour.

color. Preventing too much color in the first batch keeps the finished creek from getting too opaque later, as the opacity builds up. The first layer was about 1/8" deep, and the second came out somewhat less.

After the first pour set up, I noted a few places where I could anticipate the next pour flowing too much over some elevation changes, so I built up some taller dams with the caulk as I did before the first pour. I let the caulk dry for a full day before pouring more resin.

Compare to the previous photos for how much more intense the color looks with the additional thickness of resin [4, 5]. Things are starting to look good and muddy.

One annoying characteristic of the resin is how it creeps around the edges. It can get into surrounding scenery materials, and soak into something like sand for quite some distance.

You can see where it's oozed in these photos. Not to worry; we take care of that next.

Rapids and Touch Up

Whenever water flows sharply downhill, or encounters an obstacle, the resulting turbulence can create a need for modeling white water. Cedar Creek has some rapids, but no large waterfalls. The major rapids are just a buildup of caulk and the resin that flowed over it, plus some paint.



5. Here is the downstream end again.



J. Fugate

REFERENCE PHOTOS: GOOGLE IS YOUR FRIEND

When doing scenery, if you want more realistic results, I recommend always using reference photos. And thanks to Google, scenery reference photos are a few key-strokes, mouse clicks, or screen taps away.

Ironically, modelers would never think of modeling a locomotive or a piece of rolling stock without reference photos – the same should be true for scenery modeling as well. Don't rely on your mind's eye or imagination unless you are already a very experienced modeler of realistic scenery. Study the reference photos and practice first on some scraps before working on your layout's actual scenery!

Using a pile of reference photos, I applied acrylic paint to add whitewater as appropriate [6, 7]. Acrylic builds up in semi-translucent layers, which is just what we want. Some areas get very little paint, almost a wash, others get more, and still more until the white covers everything. Study real whitewater photos closely if you want to get the look correct.

Work slowly, building the whitewater up in layers. Don't try to paint it all with one coat – it won't look right. Practice on scraps first to refine your technique and make your mistakes there, not on the layout

Also at this stage, I dry-brushed rock and dirt colors onto any areas where the resin crept out of bounds. As part of my normal scenery finishing, I already used such paint on the rocks anyway, so the new coat blended things right in.

I eliminated shine around the banks, and also removed any resin-creep on large rocks emerging above the water surface in mid-stream.

Catch Some Waves

As it sets up naturally, epoxy produces a glassy, smooth surface that doesn't represent moving water well. I don't think it looks quite right for anything but truly stagnant places. Trying to texture the resin as it sets is a losing proposition in most circumstances. Fortunately, there are easier ways to handle it.

I like using gloss Mod Podge for ripples. Acrylic gloss medium will also work, but it's less viscous and more prone to filling with



6. Adding some white water to the stream.



7. Some additional whitewater areas.

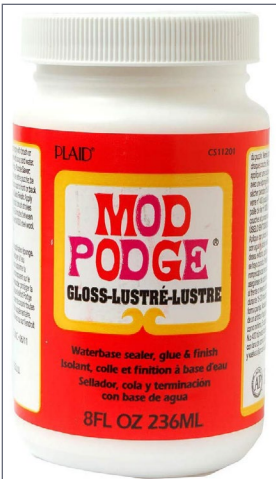

bubbles as it's applied. Whichever you like is probably fine. A disposable brush works great as an applicator.

I cover nearly the entire surface of the resin with Mod Podge [9]. Ripple patterns can vary depending on stream flow, and brush marks look appropriate around rapids, so adapt the application technique as you go.

8. Gloss Mod Podge, used to add ripples to the stream.

Reflecting on the Progress

Given that I'm modeling the '70s, I was unsure if there wasn't another Love Canal situation brewing in the train room from all the chemical processes at work, so I re-entered to check on the Mod Podge only with great trepidation.

In the first work session, I completed Mod Podge only as far as the bridge [10]. I intentionally left the remainder of the surface as-is to illustrate the contrast. The section with the ripples to the right of the bridge looks to me like moving water, while the rest of the mirror-smooth water to the left of the bridge just doesn't look like moving water.



9. Modge Podge ripples added over the entire stream (will dry clear).



10. Modge Podge ripples the next day (dries clear) to the right, the water to the left of the bridge is resin-only.

Also note how the glassy plain resin can reflect hard edges of room features, like the top of a backdrop, light fixtures, and so on. The ripples diffuse such unrealistic reflections so they don't intrude on the scene.



THE Ah-HAH MOMENT
Joe Fugate: More realistic painted backdrop clouds

Buy Issue: \$1.99 >>

In **MRH** **RUNNING** **EXTRA**



ROB SPANGLER



Rob has been active in model railroad-ing since he was six years old, and started modeling the Western Pacific in 1989. Rob and his wife Talene have two daughters, and live near Ogden, Utah. In addition to trains, Rob likes gardening, travel, reading (mostly about nature and history), and following Utah Jazz basketball. ■



CHOP NOSE RS-10

Pascal Latulippe kitbashes this unique CPRail loco from an Atlas RS-11

Buy Issue: \$1.99 >>

In **MRH** **RUNNING**
EXTRA



ACCURATE PIPE LOADS

Lew Phelps shows how to make our model pipe loads more realistic

Buy Issue: \$1.99 >>

In **MRH** **RUNNING**
EXTRA

2003 Celebrating 15 Years! **2018**
OF TRACK BUILDING INNOVATION

FAST TRACKS

Build your own trackwork easily, quickly, and affordably.

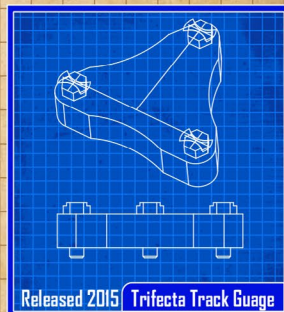
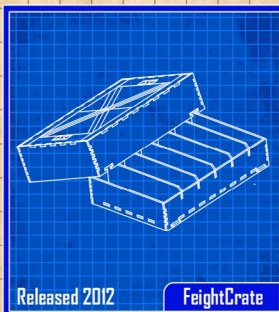
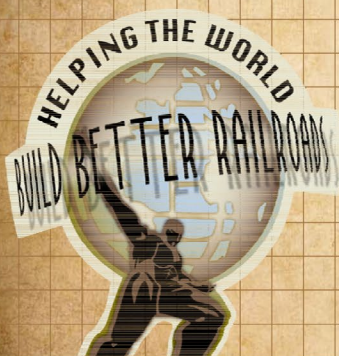
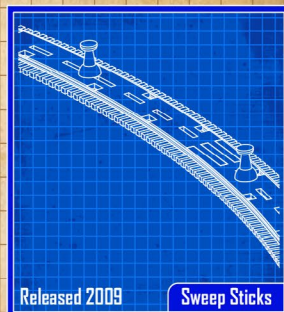
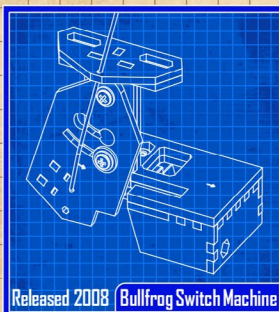
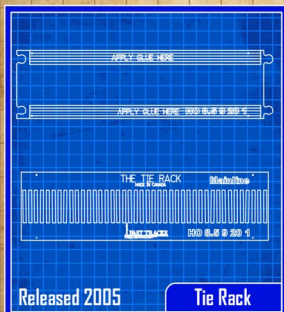
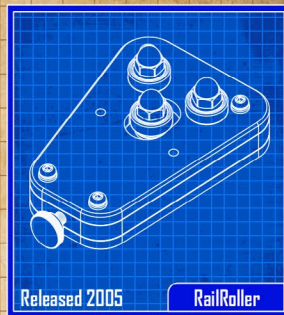
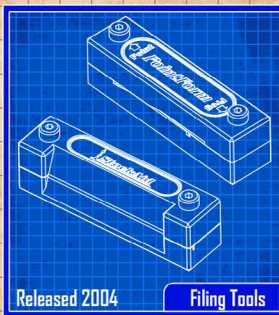
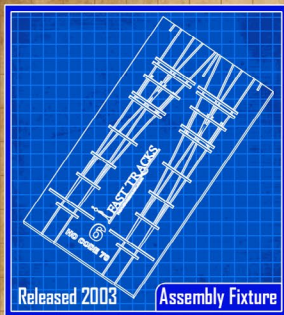

Easy ordering • Live online support • Earn Waypoints with every purchase

shop online 24/7 handlaidtrack.com

1-888-252-3895

service@fast-tracks.net



Zephyr Express, the Fast Track to Digitrax Complete Train Control

- **3.0 Amp LocoNet Command Station, Booster, & Throttle**
- **Color 2.4" LCD Screen**
- **Large Backlit Keypad**
- **Runs up to 20 Loco addresses and throttles**
- **Integrated USB Computer Interface**
- **Control lights and sound with 29 functions**
- **Simple Set-Up with Easy to read display**



Find out more @ www.digitrax.com/dcs52

Introducing

ZEPHYR *express*™



\$235.00 MSRP

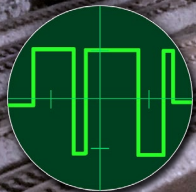

Electrical
Impulses

Passenger car lighting enhancements

Model Railroad Hobbyist | February 2019 | #108

LOU ANGEUCCI adds better lighting to his N scale passenger cars ...

PASSENGER CAR LIGHTING FOR N SCALE HAS ALWAYS been an issue, and there have not been easy solutions for the situation. Typically, many of us use the Kato N scale after-market passenger car sets and lighting kits for our cars.

1. One of my passenger trains using my Type 1 build lighting. In this article, I present three different kinds of lighting upgrades for both Kato and non-Kato passenger cars.



RATE THIS ARTICLE

YouTube has many videos showing how to install these lighting kits, and the Kato lighting system works well enough.

But for those who want better passenger car lighting or who crave perfection, I've found some shortcomings.

■ **Expense**

Kato engines and passenger car sets can get expensive – well into the \$200+ range. In addition, an add-on lighting kit must be purchased for each passenger car. The alternative lighting system presented here isn't any cheaper than the Kato system but it does provide more uniform lighting in the car. I did the Type 1 build with non-Kato passenger cars – so with this in mind, it is cheaper than buying the Kato passenger car sets.

■ **Ability to assemble the light kit into the car**

There must be a willingness and required skill level to install and maintain the Kato lighting system in the Kato passenger cars.

■ **Light flickering during train transit**

This might seem at first to be just an alignment or connection issue. But when it happens continuously, it gets quite frustrating. Correcting the issue requires disassembling and re-aligning the Kato kit copper slides each time.

■ Uneven lighting in the car

Although a plastic light diffuser is provided with each Kato lighting kit, light distribution is not even throughout the passenger car. I see this happen with passenger cars using the Kato lighting system (Kato 11-212 LED Interior Lighting Kit [version 2] six-piece set). This is probably the biggest drawback of the Kato lighting system.

■ The limitation of running just Kato rolling stock

Because of mismatches in couplers, you are limited to running only Kato rolling stock and train sets with the Kato passenger car lighting system.

Kato is a great company and they make excellent model trains in N and HO Scale. By all means use their rolling stock and passenger car lighting system if this is what you prefer. In [1] I'm using Kato track, too. The engine is a Kato FP40 Amtrak, and is an excellent runner.

The Kato lighting kit has a small slip-in assembly with a single LED light source. Installation includes properly placing a plastic diffuser in the roof of the car to spread the light to the remainder of the car.

When you peer into a Kato kit-lighted car, you will see a bright light at one end (the LED) and very dim lighting at the other end. Also, if the electrical copper slide connections on the base of the car are not tight or are misaligned in any way, the light flickers as the car travels down the track.

With this article, I present three passenger car lighting alternatives.



RATE THIS ARTICLE

PASSENGER CAR LIGHTING | 4



J. Fugate

WORKS IN OTHER SCALES TOO!

The circuits and the techniques in this article apply just as well to the larger scales, even though the focus here is N scale passenger car lighting. *Learn to extrapolate articles such as this to your own scale and situation – and you will discover a lot of treasure you may otherwise miss!*

ADVERTISEMENT

Make Loconet wiring extremely simple!

ACCU-LITES, inc

Your DCC Center!

Dealer Inquiries Accepted



PM42
breakout
board



SE8C
breakout
board



BDL168
Multi-zone
breakout board



BDL168
Single-zone
breakout board



Now Offering SNAPS! in packs of 6 or 12 pieces! [CLICK TO LEARN MORE ...](#)

MRHMAG.COM

[INDEX](#)

[TABLE OF CONTENTS](#)

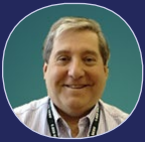

L. Angelucci

CAVEATS

This article discusses alternate N scale passenger car lighting solutions, and requires some familiarity with electronics and soldering.

I wrote this article with DC layout control in mind, but the digikdeijs DR100 White LED circuit board will work with DCC systems as well. The Type 3 build uses an alternate light strip that should also function with DCC systems and is adaptable to almost any scale.



TYPE 1 BUILD: This uses non-Kato passenger cars but with Kato conductive pickup trucks. It can be adapted to many non-Kato passenger cars.

TYPE 2 BUILD: This uses Kato passenger cars and Kato conductive trucks, but provides an alternative to lighting the interior of Kato N scale passenger cars. It does not use the Kato lighting system.

TYPE 3 BUILD: This uses the build recommendations of Type 1 or Type 2, but with more universally available LED light source

2. DT100 lighting kit used in Type 1 and Type 2 builds.

Don't settle for all your locos
sounding the same!

ESU now has **OVER 100**
"LokSound" files to choose from!

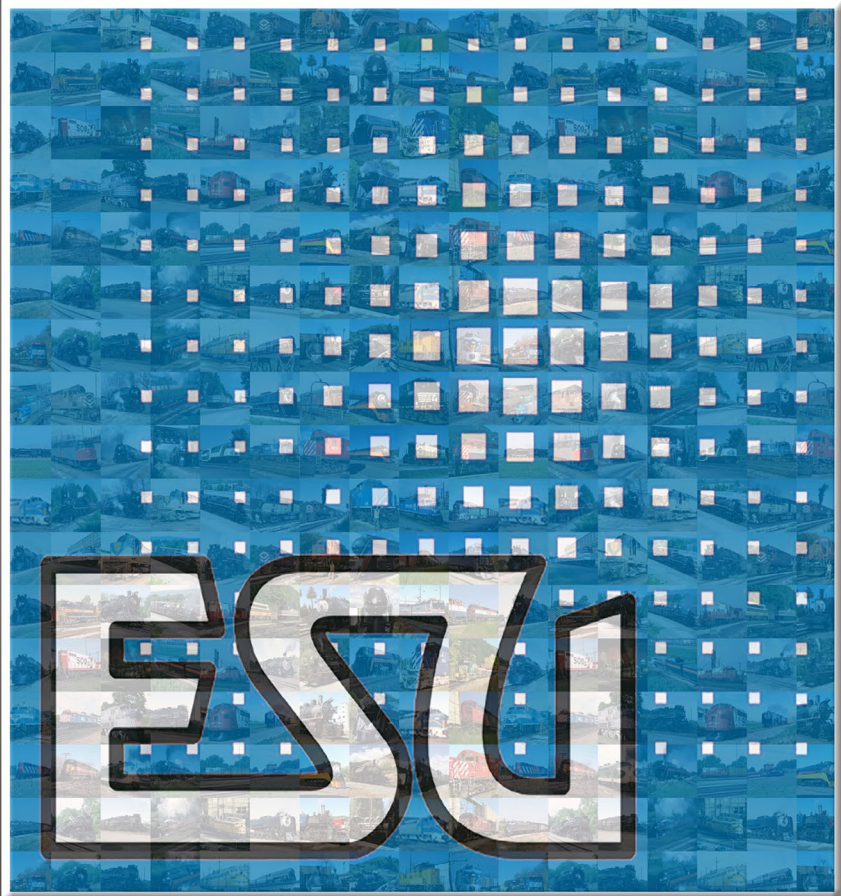

Because "Close Enough" is no longer
"Good Enough"

LokSound.com



Southern Digital

WWW.SODIGI.COM

Celebrating 25 Years of serving you !

Complete wireless **Wi-Fi** Smart Phone Interface **Digitrax Zephyr Set** *Supports up to 5 phone throttles at a time!*

Software Downloads for both Android (Engine Driver)
or Apple (WiThrottle) cell phones. Free Lite version or
Advanced paid versions available.



• Engine Driver
(support link)



• WiThrottle
(support link)



Digitrax
Complete Train Control



\$336.95 Value
\$265.00 Your Price
\$71.95 You Save

DCC Conversions, Service & Support

E-mail: sales@sodigi.com (770) 929-1888





3. Non-Kato passenger cars used for the Type 1 build.

that can be used in any scale. With Type 3, the DR100 kit is not required – but a separately purchased LED light reel is required.

All three builds require additional parts, extra wiring, and a basic understanding of electronics and soldering electronic components.

Both Type 1 and Type 2 make use of a separately purchased lighting kit, namely digikdeijs DR100 white LED kit sold by Iron Planet Hobbies [2].

Type 1 Build

(DR100 LED Light board with non-Kato Passenger Cars)

This first lighting solution uses the pre-packaged lighting kit DR100 white light, by Digikdeijs, with modifications.

This kit is all-inclusive. The kit includes two SMD (surface-mount device) LED light boards, two 100uF capacitors, two axle wheel truck forks, double-sided mounting tape strips, and a package of 20 seated people figures.

My collection includes many older trains and passenger cars which are not lighted and use the Rapido-type couplers. These are not compatible with Kato or knuckle-type couplers. Of course, the Kato / knuckle couplers do a superior job of coupling cars in N scale.

For this build, I chose Arnold Rivarossi Amtrak-type/Phase 1 fleet passenger car sets [3]. I like Arnold Rivarossi Amtrak decorated sets 0512 and 0528 even though they are somewhat older products now.

Type 1 Build steps

Lighting kit DR100 provides an excellent LED SMD circuit board [4]. #30 wire can easily be soldered onto the tabs provided. There are actually *two* circuit boards provided as a single larger board. For this build I cut the single board in two at the middle.

The DR100 kit includes under-wheel forks (electrical pickup via the trucks), capacitors, and double-sided tape strips – I did not use these.

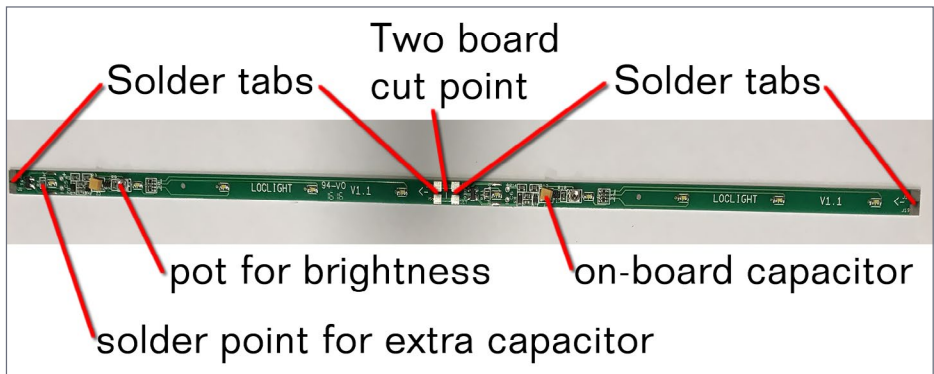

4. Lighting board in the digikdeijs lighting kit.

I do not recommend the fork option – they do not provide reliable electrical continuity. If not placed correctly or if they are too long for the wheelbase, they can get caught in the track ties. They also increase drag on the wheels. When multiplied by the number of cars to be pulled, the engine may not even move!

Instead, I used Kato trucks with conductive wheels (see parts list) with manufacturer-installed electrical pickups and a modified passenger car underbody to accommodate them.



5. Altering the underside of the passenger cars to allow for Kato lighting contact tabs around the trucks.

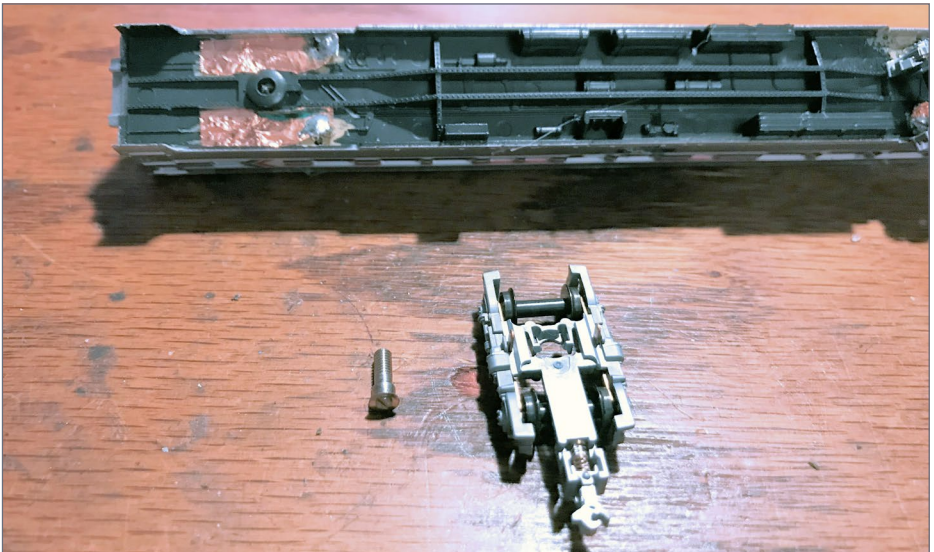

6. Copper foil applied to the smoothed-out area over the trucks.



***Don't miss out on our full line
of DCC Products at GREAT Prices!***

***Digitrax, NCE, SoundTraxx,
ESU LokSound, TCS, TVD, Speakers***

Click here to visit our website:

**www.LitchfieldStation.com
sales@litchfieldstation.com | 623-298-7355**

Two 100uF capacitors also come with the lighting kit. These certainly could be used, but to better reduce flickering, I recommend a higher capacitance – I used a 470uF 25V SMD electrolytic capacitor. I use capacitors rated for at least 25V as extra protection.

Though the kit double-sided tape could be used to affix the circuit board to the underside of the car roof, I instead glued the LED circuit board in place using E600 glue.

I like that this kit includes a set of 20 seated people. Seeing seated people through the windows of passenger cars adds realism.

Due to the low seat profiles, I had to cut away the legs of the seated people. This works fine since the legs can't be easily seen through the windows.

With non-Kato passenger cars, the underside of the car just above the trucks may need to be shaped to clear away any obstructions [5]. Keep the screw hole and mount for attaching the trucks.

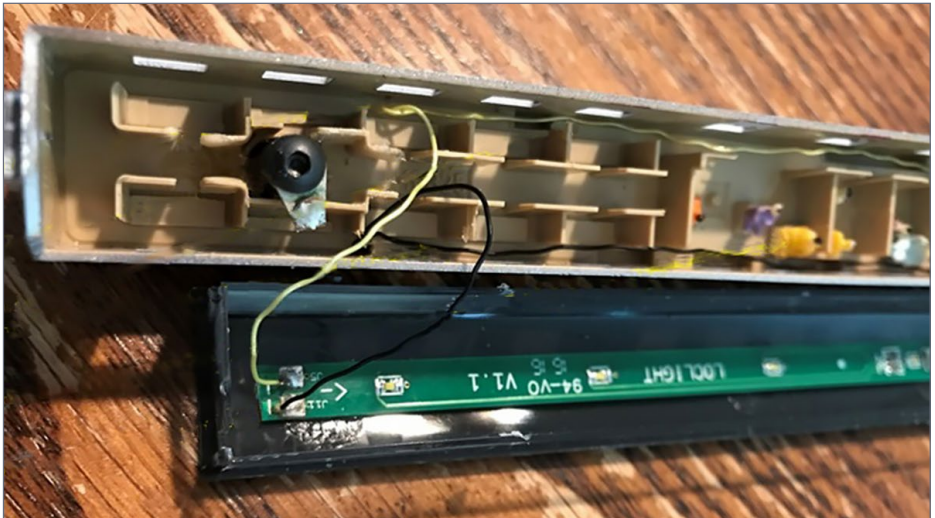

7. Wiring inside the car.

PASSENGER CAR LIGHTING | 10



Watch on
YouTube

HAVING FUN WITH TRAINS
MRH
MODEL RAILROAD HOBBYIST

MRH February 2019 issue:
Improved passenger car lighting

February
2019

Video: The finished passenger cars in action.

ADVERTISEMENT

www.SBS4DCC.com



ESU

TCS **WOW** Sound

OSI Solutions

ZIMO

SOUNDTRAXX

NCE
The Power of DCC

DiGiTrax

DCC Specialties
INNOVATION FOR DCC

MRC
Model Rectifier Corporation

ACCUTRACK II
SPEEDOMETER

SPROG DCC
the DCC Programmer and Control Family

Digital plus
by Lenz

TAM VALLEY DEPOT
Great Electronics for Great Model Railroads

TEAM DIGITAL, LLC
Improving the world of DCC

N - HO - HO_{N3} Scale Trains

ADVERTISEMENT

LET'S GET LIT!



ASHBY AUTO PARTS

ASHBY AUTO

ASHBY AUTO

Find us on 

 **Roomettes**
Bring Your Structures to Light

MRHMAG.COM

[INDEX](#)

[TABLE OF CONTENTS](#)

PASSENGER CAR LIGHTING | 11

The reason for clearing away this undercarriage is to allow the Kato conductive tabs on the top of the trucks to move freely.

I shave the car underside clean and flat with a Dremel burr attachment, and clear debris from the flattened area afterward.

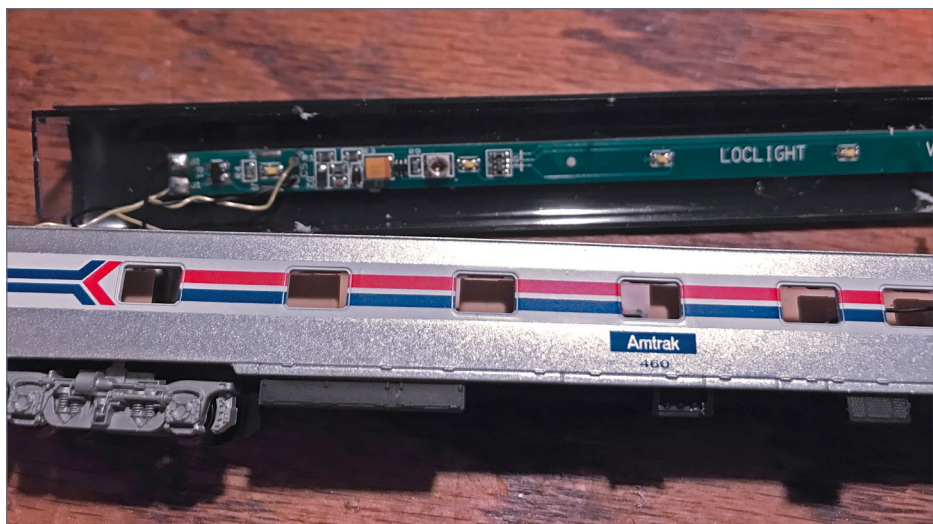

8. Circuit board mounted in the roof.



9. The lighted car.

I cut a self-adhesive copper foil strip to fit into the space [6]. This can be purchased in a roll.

I cut the foil to an appropriate length and trimmed it to curve it around truck screw mount. I use tweezers to pull the foil from the backing.

I flatten the copper foil onto the smoothed area on the underside of the passenger car. I drill 5/64" holes through body bottom just outside of foil area.

I solder 1.5 inches of #30 wire to the LED circuit board [7]. I also solder this to copper foil on the underside of the car.

Soldering

When soldering #30 wire to the copper foil, Take care so the plastic underneath does not melt. The best way to solder the wires is to first place a bit of flux on the bare wire and the copper foil.



J. Fugate

LOW TEMP SOLDER

Lou discusses techniques to minimize the chance you're going to melt the plastic underframe of your cars when soldering, but the real secret is low-temp non-lead solder – available either in sticks or paste form. Today we have low-temp solder that melts at ~275° F, well below the 400° F melting temp of plastic. You can also find temperature-controlled soldering irons for under \$50. See the January issue of MRH Running Extra for full details.

WEB: mrhmag.com/magazine/running-extra/2019-01/publishers-welcome

A soldering iron of 20 watts or less is recommended. Others transmit too much heat and will melt the plastic body for sure. After fluxing the surfaces allow the soldering iron to heat up. Using rosin-core solder, first melt a small bead on the copper foil, then tin the end of the wire.

Place the tinned wire onto the solder on the copper foil. Allow the solder bead on the foil to liquefy and merge with the wire. Then remove soldering iron and gently blow on the solder to cool it.

Repeat the process for all four foil pieces. Foil pieces on a side are to be soldered together and then to a separate wire to be attached from them to the Led circuit board [5, 6, 7, 8].

Capacitors

For these builds, I chose a 470uF 25V electrolytic capacitor [10]. Many capacitors are too large for N scale. But a larger capacitance reduces flickering, so use the largest capacitor that will fit in your space.

I said earlier I prefer a capacitor rated at 25V. Some may think this excessive, but applying higher than the rated voltage can cause a capacitor to fail or explode.

The 100uF capacitors provided with the DR100 kit are OK but I prefer a higher capacitance. I like a 220uF @ 25V (Type E SMD 7343).



10. Capacitor placement in the car.

This capacitor is smaller with a low profile that is easy to conceal.

An alternate solution is to use this capacitor circuit [11].

Why this circuit? The goal is to reduce flickering, but with SMD components, it can be difficult to get a small enough capacitor with a high capacitance value and rated at 25V. This circuit gives a higher capacitance in a smaller capacitor because it's rated at less than 25V. The 12V Zener diode and resistor limit the voltage on the capacitor to 12V, thereby protecting it.

PARTS

- R1 1K 1/8W resistor
- Z1 12V 1/2W Zener diode 1N5242B
- C1 470uF 16V SMD tantalum capacitor (477C type E SMD 7343 10%)

470uF 25V SMD electrolytic capacitor

Capacitor and circuit board using 470uF 16V SMD, 12V Zener, and 1K resistor

#30 wire connecting to DK100 circuit board (yellow is positive)

11. Capacitor circuit diagram and assembled circuit comparison to 25v capacitor.

This circuit can be assembled onto experimenter's perf board or soldered directly onto the capacitor. The different colored band on the outside of the SMD capacitor indicates the positive terminal. Solder this circuit assembly to the same capacitor solder pads of the DR100 LED light strip shown in [4].

Final assembly

With your multimeter, check for continuity of the copper foil pieces that were soldered together. Each side should have its own separate #30 wire lead to be soldered to the DR100 LED circuit board.



RATE THIS ARTICLE

ADVERTISEMENT

“I’m having
more fun
with trains
now than
I have
in years.”

TO SEE WHY
CLICK HERE

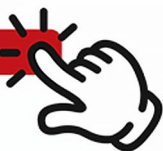

ADVERTISEMENT

TamValleyDepot.com



Celebrating 10 Years
of Serving the Hobby
2008 - 2018

Dual Frog Juicer

Automatic DCC Polarity
Reverser

Power Two Frogs

Crossovers

Crossings

Automatic Reverser for

Turntables

Wyes, Loops

Circuit Breaker

Use with 2-10 Amp Systems



MRH

Supporter
since 2009

PASSENGER CAR LIGHTING | 16

Once I have soldered the separate leads to the circuit board, I solder leads to the capacitor and corresponding polarity holes on the LED circuit board [8].

Using the small AC/DC wall adapter and alligator clips, I apply 12V to the copper foil strips to ensure that the LEDs light up. The small potentiometer on the circuit board can be adjusted to brighten the LEDs [4].

Don't turn the potentiometer too much or the entire board will be damaged and useless.

I used Kato replacement conductive trucks, purchased on the Kato parts website. I selected Kato Excursion Pullman trucks part number 800102 (see parts list).

These trucks have conductive tabs along the top of trucks. These touch the copper foil of the car body.



12. Kato passenger cars using the Type 2 build for lighting.

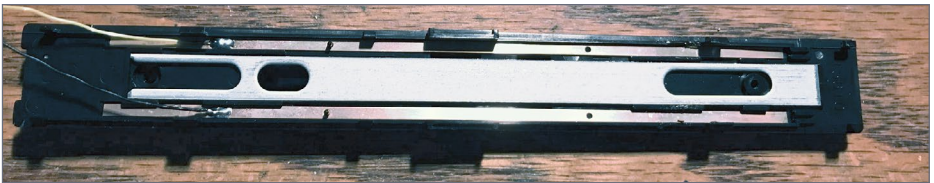

13. Solder points for the #30 wires in Kato passenger cars (seats removed).

Chassis wires soldered to board

Capacitor wires soldered to board



14. DR100 light board car wiring.



15. Finished car running on the layout.



16. LED strip reel, available in bright white or warm white.

In this build, I cemented the original internal standoff screw holder in place in the car compartment. I also used the original truck screws. The screws need to be loose so the truck swivels freely.

This is probably the weakest part of the build and, the one that involves trial and error. You want the trucks loose enough to maintain electrical contact but not so loose the car derails [6, 9].

Type 2 Build

(DR100 LED Light board with Kato Passenger Cars)

With this second build, I used a set plus one (5 cars total) of Kato corrugated Pennsylvania N scale passenger cars.

As with Build 1, I used the DR100 white LED light board instead of the separately purchased Kato light kit (Kato 11-212 LED Interior Lighting Kit [Ver. 2] 6 pcs.). Once again, I discarded the conductive forks, capacitor, and mounting tape.

However, the 470uF capacitor may be a bit large for Kato passenger cars. While you can try the 100uF capacitor provided with the DR100 kit, I recommend the capacitor circuit [11].

The capacitors are soldered to +/- holes on the circuit board.

To make an electrical connection for the light board, the seat section of the passenger car must be removed, allowing accessing the underlying copper contact strip and exposing the internal weight – just be careful to not jostle the weight out of place [13].

Gently solder two #30 wire leads separately to each side without overheating the strip or plastic floor. If necessary, remove the copper strips and solder the leads on separately. Route these wires toward the center line, and gently replace the seat section [13].

As with build 1, seated people can be glued into place onto the seats of the passenger car – the legs of the individual seated people need to be removed for them to fit.

Solder the wire leads from the copper contact strip to the tabs of the DR100 LED circuit board. Then solder the #30 wires from the capacitor to the component + and - holes located on the LED circuit board [14].

Once done, glue the LED circuit board to the inside of the roof of the passenger car and snap the body into place over the seat and chassis assembly. Run your finished and lighted car on the layout [15].

Tabs can be used as solder points for power or components



Cuttable every 3 LEDs without damage

17. LED strip can be cut and soldered to, as shown here. Note the + sign indicating the positive copper pad.

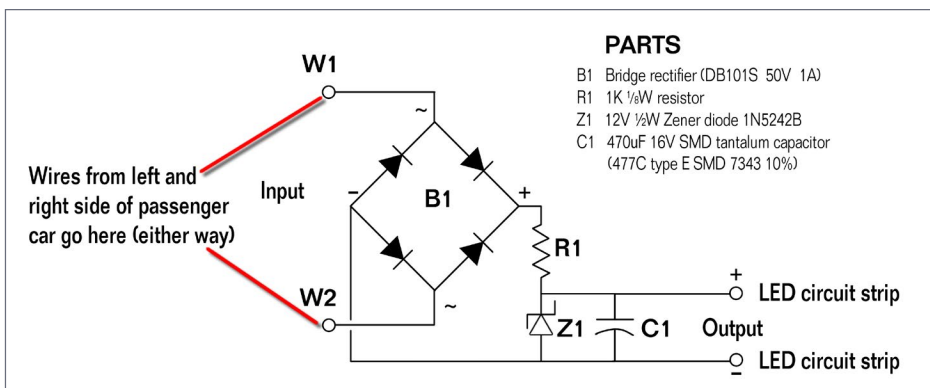

18. LED lighting circuit with bridge rectifier for DCC.

Type 3 Build

(Alternate LED Light strip with either Kato or non-Kato passenger cars)

This build uses the recommendations from Type 1 or Type 2, but with a completely different LED light source.

For non-Kato passenger cars, follow the car preparation steps as described in Build 1 through all the wiring steps, except for the DR100 LED SMD circuit light board.

For Kato passenger cars, follow the car preparation and wiring steps as described in Build 2 through all the wiring but again not using the DR100 LED SMD circuit light board.

Instead, purchase a reel of LED lights that can be cut to length. These come in bright white or warm white [16].

I got the strip I used on Ebay as “5M 3528SMD 12VDC LED light strip (non-waterproof)” that can be cut to any length as needed. As a minimum, a strip needs three LEDs per segment, but the overall length can be as long as you desire.

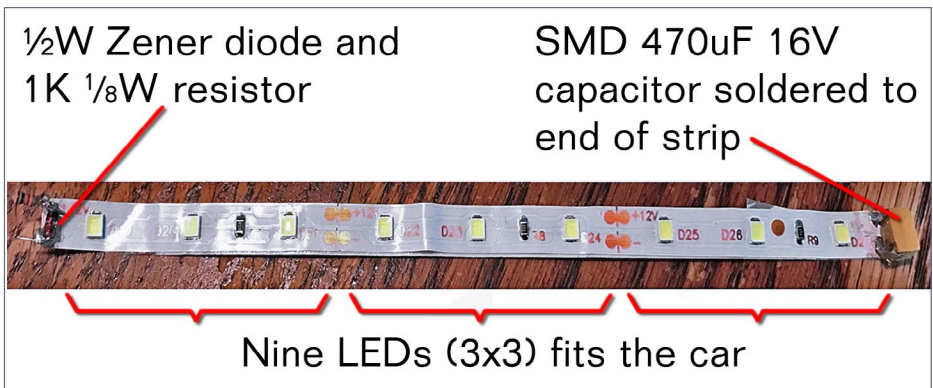

19. Components wired to LED strip.

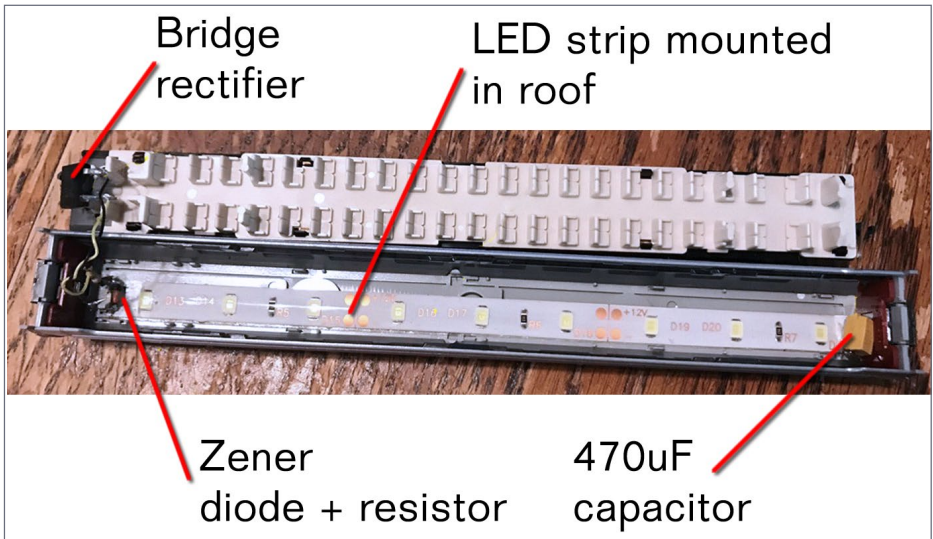

20. All the components mounted in the car.

In other words, don't use just one or two LEDs. The three LED minimum forms a circuit unto itself. You can solder multiple segments together.

For most N scale passenger cars, a length of nine LEDs (three segments of three) will fit nicely into the roof of the car. For shorter cars such as a baggage car, a set of 6 LEDs (two segments of three) will do just fine. The strips are marked with the proper polarity and where the strip can be cut [17].

When buying an LED strip, choose the color you prefer (bright white or warm white). With this build, I went with bright white LEDs.

For LED size, be sure to purchase the 5M 3528SMD 12V strip. Also choose the non-waterproof variety. The waterproof variety has a continuous plastic coating on the light side. (This waterproof strip can yellow over time, changing the color of the lights, so avoid the waterproof strips. – ed.)

The lead wires at the beginning of the strip can be removed by cutting away the first three-LED segment. Reel LEDs come with a self-stick backing to attach the completed strip to the interior roof of the car.

This install requires a circuit with a bridge rectifier so it works with DCC as well as with DC [18].

All components, except for the bridge rectifier (DB101S Bridge rectifier 50V 1A), can be soldered onto the tabs of the nine or six LED light strip [19]. Because the circuit uses a bridge rectifier, the AC input tabs can be soldered to the #30 wires connecting the left and right conductive sides of the passenger car/truck assemblies.

The resistor-capacitor arrangement limits the voltage to no more than 12V DC regardless of the track voltage. If the voltage is below 12V, the LEDs will still light at the minimum threshold voltage of around 7 volts DC.

This circuit can be used for both Kato and non-Kato passenger cars. Follow Build 1 for non-Kato cars and Build 2 for Kato cars as to wiring. This light strip assembly replaces using the DK100 LED light circuit board.

For Build 3, I used a Kato passenger car as the example [20].

There is no dimming option with this build other than to change the value of R1. You could also add a small 5 meg-ohm trim pot to the circuit shown in [18] in series with R1.

Conclusion

I am hoping these examples show what can be done to light Kato and non-Kato N scale passenger cars.

My goal was to establish a more uniform, constant lighting in passenger cars. [The video on page 10](#) shows the finished cars being pulled by Kato engines on an N scale layout.

Cars lighted with these build methods have no flickering, and the light remains uniform and constant throughout the trip around the N scale layout.

In terms of cost, there is not any cost savings with these builds or the use of the Digikdeijs kit DR100. Cost was not the main consideration however. My goal was to achieve a better more uniform lighting system.

If you are an N scale enthusiast, now you can have uniformly lighted and flicker-free passenger cars for running on your railroad.



ADVERTISEMENT

Great control in a tiny package



- Touch Toggle™ plug in controls
- Bright clear indication
- Easy setup
- Flexable system

Stall Motors, Twin-coils,
Power, and Servos

Now for Tam Valley Depot
and MRservo too!

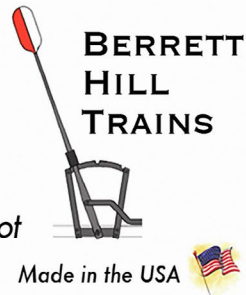

Made in the USA 

What will they think of next?

www.berretthillshop.com

TOOLS

The tools required for this project are as follows:

- A Dremel, appropriate collets and small carving bit
- Dremel 2-Count Steel Carving/cutting Bit
- Small needle nose pliers
- Small diagonal wire cutters
- Small tweezers
- 20 Watt soldering iron
- rosin-core solder and separate flux paste
- Small slotted and Philips screw drivers
- #30 wire stripper
- 5/64-inch drill bit
- 3 to 12 VDC adjustable wall adapter
- Small alligator test leads (4)
- Small volt/Ohm meter
- E600 cement and glue X-Acto knife with fresh blades



PARTS

Part 1 Parts (For one car only)

- 2 Kato Excursion Pullman trucks part number 800102 (2/package)
- 1 Digikdeij's DR100 N scale white light passenger car lighting kit, (source Iron Planet Hobbies, ironplanethobbies.com)
- 2 ft #30 insulated twisted pair solid wire, source eBay
- 1 470uF 25Volt SMD capacitor, alternate 220uF 25volt Type E SMD 7343
- 1 Copper self-stick foil ½ inch diameter 6 inches long (Foil Tape Single-Sided Conductive Self-Adhesive Copper Heat Insulation 6mm x10m, source eBay)
- 2 4-40 screws and nut (only needed if car screw and nut provided do not work)

Part 2 Parts (For one car only)

- 1 Any Kato passenger car
- 1 Digikdeij's DR100 white light N scale passenger car lighting kit (Iron Planet Hobbies)
- 2 ft. #30 insulated twisted pair solid wire
- 1 470uF 25Volt SMD Electrolytic capacitor or alternate (see article)

Part 3 Parts (For one car only)

- 1 Kato or non-Kato passenger car following the build recommendations of parts 1 and 2
- 1 Reel of 300 5M 3528SMD 12Vdc LED light strip, pure white or warm white as an alternative

PARTS

CONTINUED...

Pure white 6000k - 6500k Lumens or warm white 3000k – 3500k Lumens

2 ft. #30 insulated twisted pair solid wire (Ebay)

1 Bridge rectifier rated 50 volt 1 amp DB101S

1 470uF 16Volt Tantalum Capacitor, SMD 477C Type E SMD 7343

1 ½ Watt Zener Diode (1N5242B)

1 1k Ohm 1/8Watt resistor ■

ADVERTISEMENT

made in AMERICA 

Did you know that all SoundTraxx decoders are made in Durango, Colorado? Since 1990, we have been committed to crafting quality products, strengthening our national economy and creating local jobs.

When you buy SoundTraxx decoders, you support building American-made goods. And our products aren't just good—they're excellent!



Help contribute to a brighter and more stable future for the entire country by purchasing SoundTraxx decoders from your local retailer.

SOUNDTRAXX™
www.soundtraxx.com

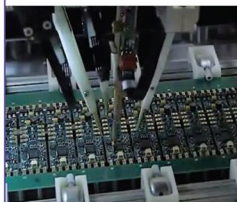

LOU ANGELUCCI



Lou Angelucci is an N scale hobbyist who has been modeling in N scale for over 20 years. Lou designs, builds and electrifies his own rolling stock and layout operations. Lou has designed and built his own N scale layout in his basement. Lou runs mainly Kato but also other makes such as Model Power, Con-Cor, and Fleischmann N scale engines and cars. No particular era or road name is modeled although there is a preference for Union Pacific. ■

ADVERTISEMENT

RailPro™

**NEW
TECHNOLOGY**

RE RING™
ENGINEERING

DCC + RADIO CONTROL

HO Scale Locomotive Module

**ULTIMATE
SERIES
SOUNDS**

**TRUE
MOTION
TECHNOLOGY**

**LIGHT
EFFECT
EDITOR**



New Sound Technology and Mathematical Model Motion Control + more!!!



+



Equals
"DUAL MODE"
Control by DCC +
Radio Control

**Click Here to
Watch Video**

For more information visit our Internet site: www.RingEngineering.com

From first train set to railroad empire...

*Our complete line of DCC products
grows with you. Discover the fun!*

- Designed and manufactured in the U.S.A.
- Preferred for ease of use and ergonomic design
- Unlimited scalability for any size model railroad
- Plug-and-play means more time running trains
- Great customer service and excellent support



See your dealer



Visit our new and improved web site for all your DCC needs!

- Get the latest new product announcements
- Watch our detailed how-to videos
- Browse the all-new Information Station
- Enjoy secure online sales, day or night!

Visit **ncedcc.com**





LOOK column

Model Railroad Hobbyist | February 2019 | #108

THE MRH STAFF looks at using Microscale 60-196 SP&S decals to model an early SP&S RS-3 in N scale ...

MICROSCALE HAS N SCALE DECALS FOR SPOKANE, Portland & Seattle Alco RS-3 diesels you can use to model the as-delivered tiger stripe maroon and olive green scheme.



1. Microscale decal set 60-196 can be used to model the SP&S as-delivered paint scheme on the N scale Atlas RS-3. See [2, 3].



RATE THIS ARTICLE

The 1600 hp RS-3 was a true multipurpose road switcher, and the SP&S acquired a total of 29. Numbers 65-82 were Phase I units delivered from 1950 to 1953. 83 and 84 were the former GN 231 and 232, acquired in 1959, and 90 through 98 were in Phase III bodies, bought in 1955.

Almost all survived into the 1970 Burlington Northern merger, and several received four-digit BN numbers without being repainted. They were routinely operated with other EMD and Alco locomotives on the SP&S and also often appeared with Great Northern units.

The 95 was the last SP&S engine to be repainted into the broad stripe scheme introduced in the summer of 1964.

Atlas makes this locomotive in N scale, although does not and has never offered this paint scheme. More recent Atlas N scale models of the RS-3 come with body-mounted couplers,



2. Engineer's side view of an N scale Atlas RS-3 painted and lettered to represent an early SP&S loco.

directional lighting, low-friction drive and are DCC-ready. The photos here show an Atlas RS-3 painted and lettered for this paint scheme [2, 3].

Well over 1,300 RS-3 road-switcher locomotives were built by ALCO between 1950 and 1956. These locomotives were powered by an ALCO 244 V-12 engine which was complemented by rugged GE electrical components. Nationwide, the RS-3 could be found in virtually every type of service from passenger and commuter runs to heavy-haul and local freight assignments.

Microscale SP&S switcher decals

Use this google search to find these decals – type in: microscale 60-196

LINK: [google.com/search?q=microscale%2060-196](https://www.google.com/search?q=microscale%2060-196)



3. Fireman's side view of the SP&S RS-3 in the as-delivered scheme.

Atlas N scale RS-3

Use this Google search to find models for sale – type in: atlas N RS-3 for sale

LINK: [google.com/search?q=atlas%20N%20RS-3%20for%20sale](https://www.google.com/search?q=atlas%20N%20RS-3%20for%20sale)

N Scale MSRP: \$119.95



UPGRADE YOUR LOCO FLEET
Tony Thompson on getting a more realistic loco fleet

Buy Issue: \$1.99 >>

In **MRH** **RUNNING** **EXTRA**



ADVERTISEMENT

END OF TRAIN DEVICE

NEW SAFETY GREEN



Bright Red Flashing Light!

Installs in minutes!
No freight car modification required!

Patented Technology - US Patent 7,549,609

Does not affect Load!

↓ Car without Load ↓



↓ Car with Load ↓



Click Here to Learn More

RE RING
ENGINEERING

Make it run like a

Dream ROLLING STOCK

102 pages

By Joe Fugate

SPECIAL
PRICING ENDS SOON!

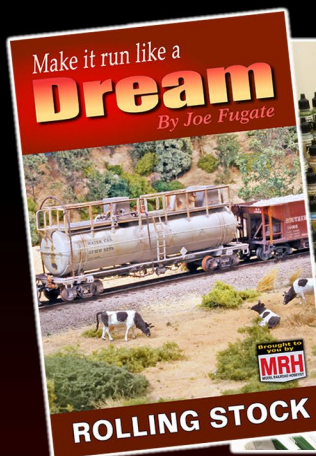

TOPICS INCLUDE: Setting standards • Building a test track • Wheelset/truck issues • Coupler issues • Carbody issues • Car weight considerations • Better maintenance procedures • Performance diagnosis & debugging • Special considerations

Click me to
Get eBook NOW >>

~~\$12.99~~ **\$11.49**

Format: Landscape and
Portrait PDF

Click me to
ORDER PAPERBACK >>

~~\$29.99~~ **\$28.49**

FREE shipping in US!
Foreign shipping 50%

Other books in this series: TRACKWORK (available now) and LOCOS (End 2019)

WHAT'S NEAT

column



Model Railroad Hobbyist | February 2019 | #108

KEN PATTERSON VISITS A BASEMENT-FILLING HON3 RAILROAD, LEARNS ABOUT MANUFACTURING MODELS AT INTERMOUNTAIN RAILWAY COMPANY, AND CHECKS OUT THE BEHIND-THE-SCENES CONTROL SYSTEM AT THE COLORADO MODEL RAILROAD MUSEUM ...



RATE THIS ARTICLE

THIS MONTH WE VISIT INTERMOUNTAIN RAILWAY Company. We look at Art Lort's HON3 layout and we visit again at the Colorado Model Railroad Museum's 5000 sq. ft. layout to see how it is powered and controlled. There are 19 NCE power districts and an automatic computer control system. There are a lot of great modeled outdoor and indoor runbys in this month's video.



THE LIMITED MODELER

Jim Six: The secret to staying motivated

Buy Issue: \$1.99 >>

In **MRH** **RUNNING**
EXTRA



▶ PHOTOS AND VIDEO OF SUPERB MODELING

InterMountain Railway



1. I visited Ron Angstead at InterMountain Railway Company in Longmont, CO a few weeks ago to see what was new. Ron said he had been to China in the past few weeks and has secured manufacturing for all their new products in 2019.

Ron was very enthusiastic about InterMountain's future. Newer computer technology will allow the production of detailed models like we have never seen before. The Longmont facility is clean with high-tech computer controlled milling machines for die production. The computer design rooms are alive with developers designing the new models for the next three years and the shipping department is busy with in-stock products being shipped hourly. It was wonderful to feel the positive atmosphere of InterMountain Railway Company during my visit.



Watch on
You Tube

HAVING FUN WITH TRAINS
MRH
MODEL RAILROAD HOBBYIST

MRH February 2019 issue:
What's Neat with Ken Patterson

February
2019

The thumbnail shows two men in a workshop setting, one in a plaid shirt and the other in a dark shirt, standing near a model train layout. A large red play button is overlaid in the center. A film strip graphic is visible on the right side.

ADVERTISEMENT

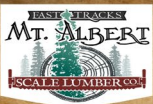

Introducing
THE
LUMBER STORE



ROTATING STORAGE RACK

On its own, or fully loaded with Mt. Albert Scale Lumber!

handlaidtrack.com

1-888-252-3895

Art Lort's Colorado narrow gauge



2-4. (Top left, top and bottom right) Art Lort's big and amazing HO_n3 railroad occupies his entire basement. The layout is standard gauge in some areas and HO_n3 on the remaining 75%. Scenery climbs from waist level to way above head height as the consists traverse 4% grades, just like the prototype of the era 1887 – Art's favorite modeling period. His favorite place, Marshall Pass on the Denver & Rio Grande Western, inspired the entire concept of his layout. The railroad took 20 years to build while Art moved from one house to another. Sections of the layout moved as he added new scenes. Art operates the layout with a car card system and a time clock. He says it takes eight operators to run a three-hour session replicating an eight to 10 hour working shift. The scenery looks just like the prototype. Art used real dirt from the modeled locations and studied photographs and drawings to model the Colorado mountains and his incredible bridge and river scenes.

WHAT'S NEAT | 5



Also see the new "What's neat this week" weekly video podcast!

**WATCH
NOW** >>

Colorado Model Railroad Museum: Control system



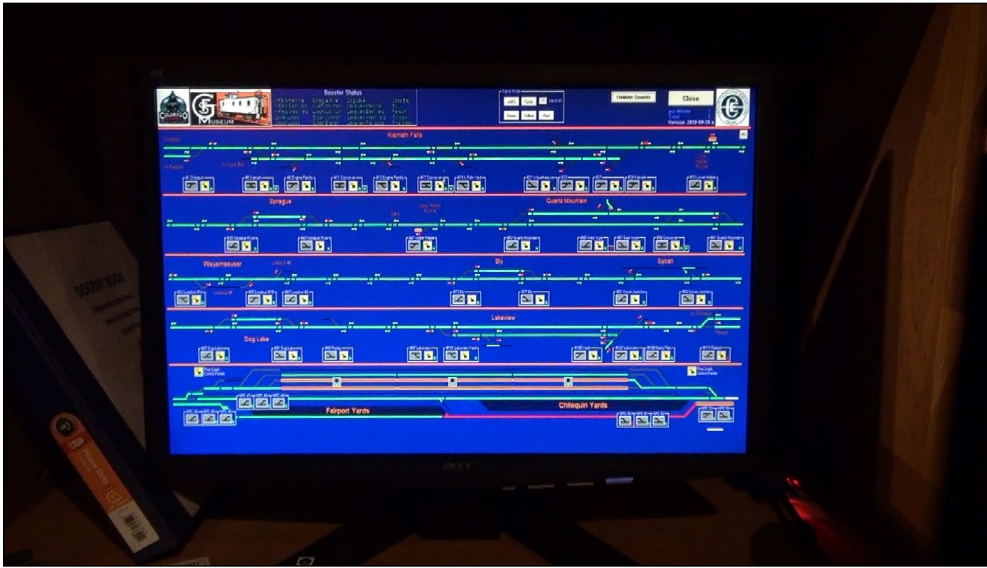

5-7. (Top left, top and bottom right) The Colorado Model Railroad Museum has been covered in previous “What’s Neat” videos as of late, but we have only scratched the surface with the scenery and esthetics of the overall museum. Today we dive in to the electronics that run the layout. Systems are custom-built with code written specifically for the layout, considering the amount of trains, the length of the passing sidings, and the necessary signals.

What am I saying? This layout can automatically run nine trains at one time on the single track mainline using the passing sidings, signals, timing, scale speed and so on, all day long with no derailments or collisions. That’s amazing. The layout is controlled by multiple computers with one in control and the remainder running as a live back-up in the event the first one skips a beat. Randy Palmer designed the system and wrote the code. He shows in this month’s video how the system starts, selects seven trains, pulls them out on to the main line in a pre-planned sequence, and then runs them along the main line all day until it is time to shut down.

When the museum closes, the trains then park themselves in the switch yard ready for the next day's run.

Randy designed the program in Microsoft Visual Basic 6 to show all the track patterns on the screen. In Play/Run mode, the CTC machine in the museum is not used to control the trains but still lights up and operates as if a dispatcher is running it. Randy says the program in fact is named "Dispatcher."

He took over six months to write the program, drawing the track pattern of the layout exactly, and matching everything switch by switch, and foot by mainline foot while translating all these numbers into the computer program.

Randy says his "AH-HAH" moment was when he figured he could program the trains to see the red and green signals just as a person operating the layout would do with their eyes. That was the moment when he figured out how the system would work with model trains, timing things exactly for successful running all day long. There are 19 NCE DCC systems running the layouts with hundreds of individual signal controllers feeding information to the computer. You must watch this month's video to in real time on how exactly the system works.



BUILD A RESIN REEFER

Bill Gill builds a resin express reefer kit, upgrading it as he goes.

Buy Issue: \$1.99 >>

In **MRH** **RUNNING**
EXTRA



Also see the new "What's neat this week" weekly video podcast!



Have you seen this?

**CHECK IT
OUT!**



kenpatterson.com

click here to ...

Visit Ken's website

**Ken Patterson
reveals his modeling
secrets on video!**

Ultimate switching tutorial

Up close and personal ...

with Mike Confalone

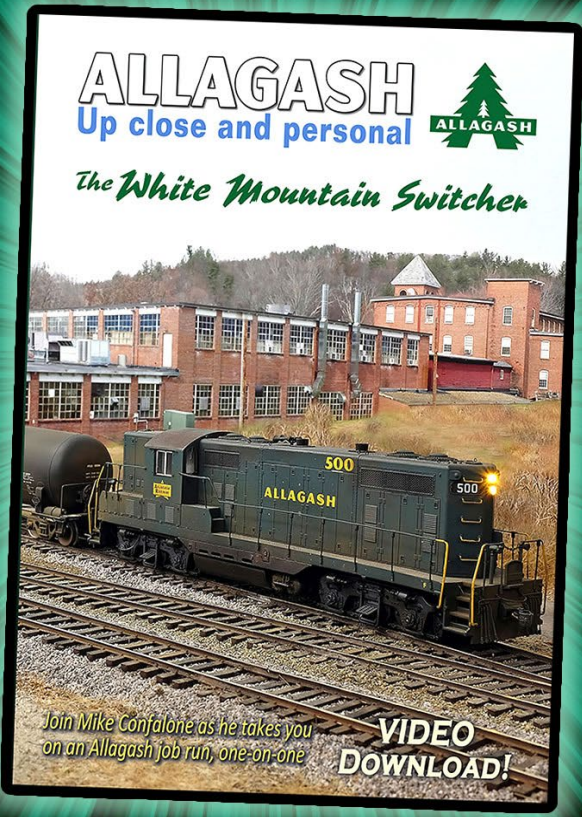

Now Available!

DVD media
~~\$29.99~~
\$24.99
FREE shipping US
50% off shipping foreign

Video download
~~\$14.99~~
\$9.99

HD format

Running time: 2 hours (sale ends soon!)

 Get White Mtn Switcher video

from the
Model Railroad Hobbyist Store

MRH ... QUESTIONS, ANSWERS, TIPS



Conversations from the MRH
online forums

Model Railroad Hobbyist | February 2019 | #108

compiled by **JOE BRUGGER**



Air eraser

Q. I pulled out my Harbor Freight air eraser (model #69277) to start weathering a few cars. It's a cool tool EXCEPT the tip clogs on average every 5-10 seconds, so I spend more time removing it and blowing it out than erasing. Despite that, it gives a nice effect on lettering. I've been using HF air eraser compound with decent results and would like to try baking soda. Air is from a small DeWalt compressor with the integrated regulator set to 25-30 psi and a cheapy inline air dryer. I'm in SE Louisiana where humidity occasionally gets high. And by occasionally I mean ALL THE TIME.

—Jeff

A. Steve Kleszyk: Try different dryers and add several inline. You can also "bake" the medium before, but not too much and don't run it through the blaster when it's hot.

▶ MRH QUESTIONS, ANSWERS, AND TIPS

Peter F.: You need a filter for humidity. In compressed air, humidity would make beads wet and would get the material to stick together. How does that work on decals ... or not?

Jeff: I am running a disposable inline filter but it's probably inadequate. Have not tried the air eraser on decals like Microscale, but it works well on factory lettering as shown.

Rick Sutton: My guess is that it would tend to tear the edges of the decal film and be somewhat random in effect. On the other hand, I may get my old Paasche unit out and give it a try. Could be interesting.



1. Harbor Freight's air eraser. Paasche and other companies also market air erasers designed to spray fine abrasives. Check air pressure requirements to see how powerful a compressor is needed.



2, 3. A few passes with the air eraser will take the shine off the factory finish and fade the lettering. Check the work frequently because the process is not reversible. Mask areas to protect them.

My favorite application for the air eraser was to apply two or more layers of different colors to boxcar and Central Valley cattle car roofs and "burn" through the layers to simulate wear patterns. The mess without a dedicated booth, plus the cost of the blasting material have deterred me from using it on my recent projects.

Jeff: You are spot-on, it can make a mess. I do it outside with a respirator mask on, and blast over a big plastic Rubbermaid bin which catches most of the media for reuse. The technique you used on the roofs is interesting. I'd like to try that. I am using the blasting media from HF which came with the air eraser. Not sure if it's available separately. Shooting over/in a big Rubbermaid bin allows me to reclaim most of it.

Rick Sutton: I used aluminum oxide ordered through Amazon.com. Search for "Paasche+aluminum+oxide" to find it.

BC Barney: I use this same air eraser with baking soda and it is wonderful! If I don't sift the baking soda, I get clogs every so often. Sifting dramatically reduces clogs. Sometimes I don't think

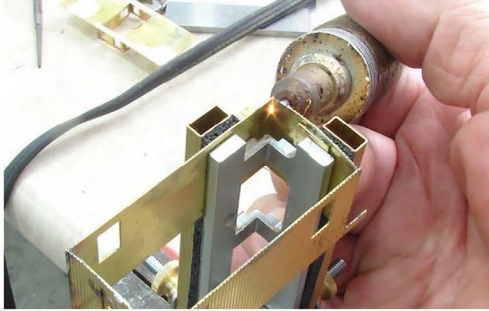
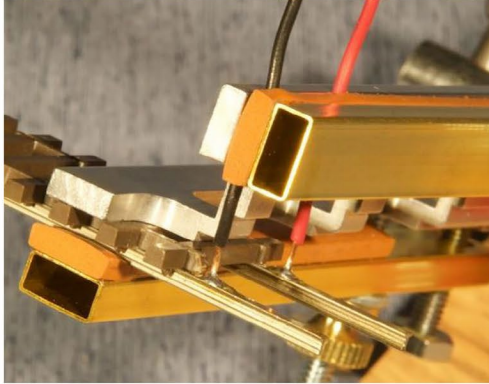
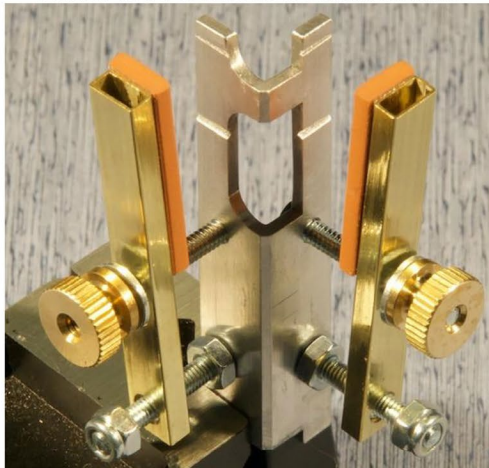

4. A finished patch-out and weathering project by Jeff, with faded lettering and added rust marks. The car is a Walthers Mainline. Similar ones are frequently available from the Walthers website for \$10-12 when they discontinue a paint scheme.

Essential Tools for Great Modeling!**Quality Tools with Superior Versatility****Solder lead wires to bottom of rails****"Combo Right Clamps"™ by
Coffman Graphic Solutions**

1500 River Circle, Richmond KY 40475

Visit our new Website:

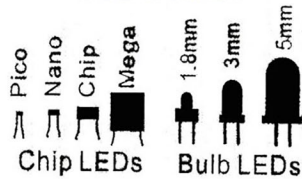
www.coffmaneng.com**LIGHTS4MODELS****LED's, Signs, and Sounds for
All Scales**

Miller Signs | Evan Designs
 Iron Penguin | Ring Engineering
 EZ Line | Tomar | ITT Sound Boards

www.lights4models.com

614-296-8691

**Lasercut structures. Highway,
storefront and billboard signs.****Neat ag customer for your railroad:
Farmers Fertilizer Supply****WHAT'S
NEW?****Established 1993...****Blair Line**

it is really spraying but just one spray over the back of my hand tells me it is. The process with this tool is slow – there's not much volume at any given time. For stripping, I use baking soda with a sand blaster I got off eBay. This works great! Go to www.ebay.com/itm/Sand-Blaster-Gravity-Feed-Abrasive-Handheld-Air.

Steve Kleszyk: I have tried different media but found baking soda was best for me. Does some cool stuff on glass too!

Read more about air erasers at mrhmag.com/node/35335.

Operating a small layout

Q. This question is born out of a recent *MRH Forum* thread. The focus of this discussion is how you operate your small layout. I'm classifying a small layout as one that fits into 120 square feet or less, so if you have a 4 x 8, an Inglenook, shelf layout, hollow-core door layout, or an around-the-wall layout in a room of 120 square feet or less, and operate your layout in a prototype manner, please tell us how you operate.

—Rich S.

A. Rich S.: Welcome to my Long Valley Industrial Railroad. In 1980 Conrail applied to the ICC to abandon the Midland Secondary and the Long Valley Branch. The local industries purchased the Long Valley Branch and enough of the Midland Secondary to maintain rail service. When the contract was signed, an MP15DC was leased from a local short line and a second-hand caboose was bought.

Even though this layout looks like a simple loop on a hollow core door, I operate the layout as if the track is out of service beyond the highway crossing located beside the Vulcan Steel Fabricating Plant. The layout is operated with car cards and waybills created using Ship It! by www.albionsoftware.com. A dispatcher grants verbal authority to the Long Valley crew to occupy the industrial track.

Must have Details

NEW DESIGNS NOT
MADE ANYWHERE ELSE

OVER **1000** DESIGNS

WWW.MODELTECHSTUDIOS.COM

N H O S O SCALE



Vehicles



Detailing



Figures

Lighting



ADVERTISEMENT

Make **REAL**
Dry Transfer
Graphics



... in less than 10 minutes!

Color
White
Metallic

DECALPRO *fx*
(850) 926-2009 (9-5 MST)



ADVERTISEMENT

Backdrop Junction

Your Stop for Railroad Backdrops

Click Here 

For the Finest in Custom
Designed backdrop



www.backdropjunction.com



Archer

FINE TRANSFERS
PROUDLY SERVING MODEL BUILDERS SINCE 1989

THE ORIGINAL

SURFACE DETAILS™

WE NOW HAVE MORE
THAN 130 SHEETS OF
RIVETS, LOUVERS,
TREADPLATE, WELD
SEAMS AND MORE
CAST ONTO
MICROSCALE CLEAR
DECAL FILM

LOW SHIPPING:

DOMESTIC USA ORDERS
\$2.80
INTERNATIONAL ORDERS
\$9.95

 **CLICK HERE TO
VISIT OUR WEBSITE!** 



MADE IN THE USA

"Archer Fine Transfers 3D decals have revolutionized kitbashing and scratchbuilding. Putting rivets or other low-relief details like louvers or weld seams on your models is now as easy as applying decals."

Joe Fugate,
Publisher/Editor
Model Railroad
Hobbyist

Archer Fine Transfers • PO Box 1277 • Youngsville, NC 27596 • USA
(919) 570-1026 • info@archertransfers.com • archertransfers.com

The day begins with Conrail delivering inbound cars to the LV's interchange yard, my open staging yard. The crew then places its caboose on the end of the train, runs around the cars, and pushes the train out past the Long Valley Junction switch. The train then proceeds to Long Valley to service the local industries. When finished, the crew moves the caboose to the other end of the train and the locomotive will lead the outbound cars back to the junction switch. The outbound cars are placed on the interchange track and the locomotive and caboose are tied down at the yard office. This ends the operating session.

Bremner: My Playa Desnuda is a fictional branch of the Pacific Electric set around 1953 in Los Angeles County, based on the Santa Monica Air Line. Just like the prototype, the overhead wire came down after the end of passenger service.

The layout is N scale. My only motive power lettered for the Pacific Electric is an Arnold SW1. I hope to add a pair of Baldwin VO1000s



5. The Long Valley Industrial Railroad may look like an oval, but Rich S. operates it as a point-to-point industrial lead.



6. Bremner has imagined an early-1950s Pacific Electric branch with freight service, based on the Santa Monica, CA area. *Pacific Electric Railway Historical Society (PERyHS.org) photo*

and am waiting on some custom decals to finish a model of a PE C-30-2 caboose.

The west half of the layout is getting closer to being finished. I scratchbuilt a freight station based on Santa Monica's, and am modeling D'Amato Lumber, based on Fisher Lumber, the last business the Southern Pacific/PE served on the Air Line.

Alcanman: The Marlborough Branch measures 9 x 1.25 feet. The track plan is a three-switch inglenook arrangement.

At the start of operations, two covered hopper cars are spotted at the hopper loading spur, two empty gondolas are on the transload track, and a boxcar is spotted at each of the warehouses. Three cars are staged at the right side of the layout. A loco shoves the three cars and switches them for three cars at the industries before the loco departs with three outbound new cars. The process is then

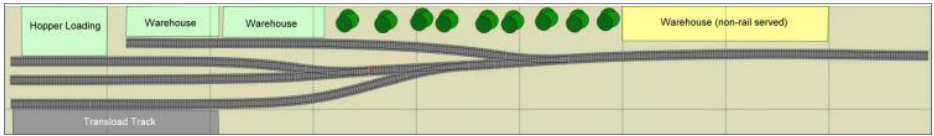

7. Alcanman's compact Marlborough Branch shelf design serves two warehouses, a transload track, a bulk hopper loading area, and a transload facility.

repeated with three other cars. A total of 12 cars are required to switch the layout.

TJ R.: Ooh, I like that Marlborough Branch! I could use that plan and modify it slightly for a 4 x 6 foot corner shelf. I also would like to see more photos of it, as an overall layout, not just the beautiful "scale" photo.

Jim Dixon: I really like that too. And all I would need is one more right-hand switch.

Alcanman: The sky background was done in Photoshop. I use the track in front of the non-rail-served warehouse as a staging track. I have now also built a small one-story warehouse in front of the staging track to provide a view block.

Deemiorgos: Stonehammer is a fictional place that depicts a coastal branch line terminus somewhere in the Canadian Maritimes circa 1956. It covers 26 square foot made up of two modules. Trains arrive from a staging area.

The layout consists of:

- a platform track and runaround track that can hold a locomotive and two passenger cars
- a warehouse/stock siding, and a fuel dealer siding with a loco lead track sized for a 2-8-2 or an RDC
- a team track that can hold four to five cars
- a turntable to turn the locos around.



8. Small layouts give the modeler who is pressed for time, space, and money a chance to do some model-building and operating, as described by Alcanman on his Marlborough Branch.

Before completing the scenery on the layout, I tried some sessions by myself and posted them here:

mrhmag.com/node/31118

mrhmag.com/node/31876?page=4

Rocket Jones: Weaver Junction is my switching layout. As it stands right now, it's an interchange and industrial cluster, set on a 5' x 1.5' base. I made a few minor changes when track was put down. The food processing company in the back is scratchbuilt, and the warehouse is a kitbashed version of Gripp's Luggage. The back wall is solid sheet styrene, with all the detail panels moved to the front and sides to create a bigger building.

For operations, I use Boyd's Simple Switchlist System (www.potomac-nmra.org/Clinics/CNPJunction2013/Boyd-SimpleSwitchlistSystem.pdf). You start off with a set of cars on the

layout and a destination list showing where everything should end up. For now, it's enough complexity for me, and I've found running these switch lists to be an excellent way of testing track-work because everything gets repeatedly exercised both forward and backward.

For more examples of small layout operations, discussion of track planning software, and the definition of a secondary main line, go to mrhmag.com/node/32014.

- 9. (Left) Stonehammer's passenger platform, station, and runaround track.
- 10. (Bottom) Rocket Jones' Weaver Junction plan.

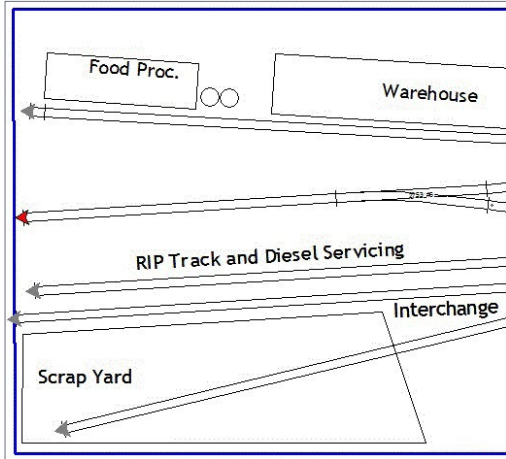

GET PAID FOR YOUR TIP

We pay **\$25 per tip** we publish, or \$40 each if the tip also includes a photo or finished drawing.

[Click here and select article type TIP.](#) ■

.....

RATE THIS ARTICLE



ACCURATE PIPE LOADS

Low Phelps shows how to make our model pipe loads more realistic

Buy Issue: \$1.99 >>

In  **RUNNING**
 **EXTRA**

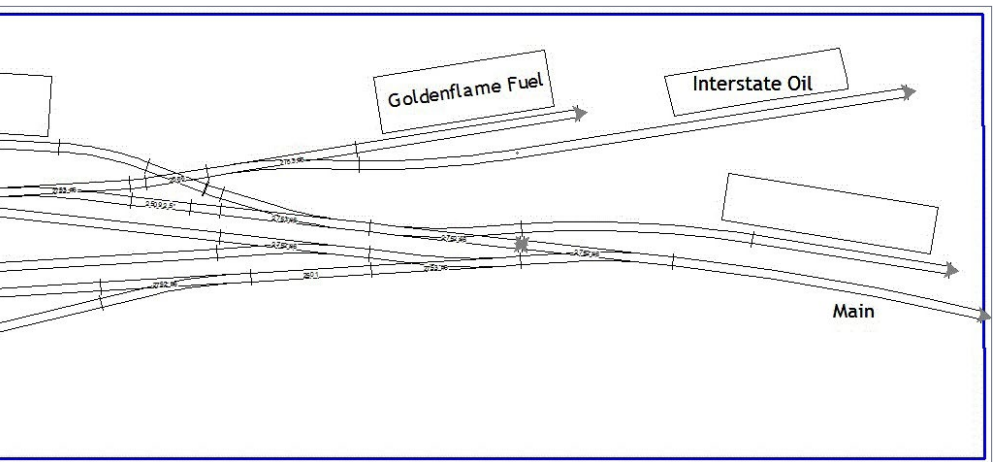



TIPS

Nail holer

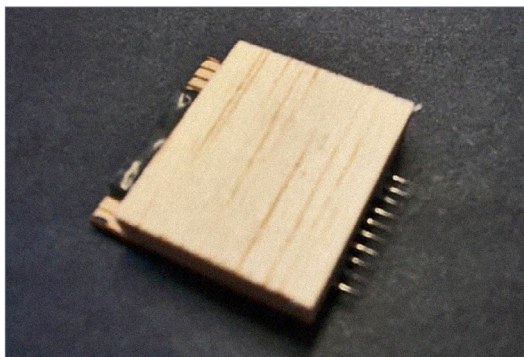

11. Straight pins and scraps of scribed siding combined make an easy-to-use “nail holer.” Either wood or plastic siding will work. *Michael Anson photo*

I got really bored poking rows of nail holes into wood siding for structures. My parts and junk drawer didn't contain a pounce wheel or a gear that had the right spacing to make the process quicker.

Using a scrap of the siding, I epoxied straight pins along each clapboard indent. I then sandwiched them with another piece of wood and clamped the assembly to embed them. I made sure all points were in line.

Now, using a straightedge as a guide, I can poke holes pretty fast. It seems a line of 10 to 15 pins work best for me, with perfect spacing for any situation.

—Michael Anson

**CHOP NOSE RS-10**

Pascal Latulippe kitbashes this unique CPRail loco from an Atlas RS-11

Buy Issue: \$1.99 >>

In **MRH** **RUNNING**
EXTRA



Bowser

EXECUTIVE LINE

HO & N Scale In Stock!!

Ready to Run. Features: Crisp details and sharp painting and printing, metal wheels and knuckle couplers.



HO 40' Boxcars



HO 70 Ton 14 Panel Hopper Cars



HO & N Scale GLa 2 Bay Hopper Cars



HO 50' Flat Cars

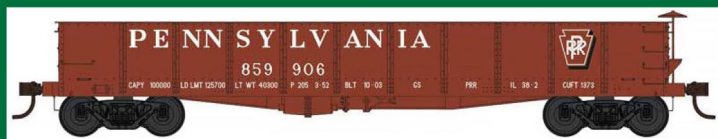

HO GS Gondolas

Click here to check out the details for these and other great Bowser products!

Freight Car super-detailing

**NEW
VIDEO!**



**PREORDER
DVD media**

**Available now
VIDEO download**

~~\$29.99~~

~~\$14.99~~

\$24.99

\$9.99

**FREE shipping US
50% off shipping foreign**

HD format

from the
**Model Railroad
Hobbyist Store**

**Get
Video**



FEBRUARY NEWS column



Model Railroad Hobbyist | February 2019 | #108

RICHARD BALE and
JEFF SHULTZ report the
latest hobby industry news



ScaleTrains addition



Stephen Priest has joined ScaleTrains.com as the marketing manager. The company was established in 2014 by former Horizon/Athearn executives Shane Wilson, Mike Hopkin, Joe Olvera, and Paul Ellis. Priest has been active in the model railroad industry for many years, most recently as editor of *Railroad Model Craftsman* magazine. He has been an active model railroad

hobbyist for more than 45 years and earned the distinction of Master Model Railroader from the National Model Railroad Association. Priest has served on the NMRA Board of Directors and has twice received the NMRA President's Award ...

NEB&W Forced to Move

The Rensselaer Model Railroad Society at Rensselaer Polytechnic Institute, Troy, NY is in need of a new home.

▶ THE LATEST MODEL RAILROAD PRODUCTS, NEWS & EVENTS

Guided since 1989 by John Nehrich, the student club built the New England Berkshire & Western Railroad, a historically based, exceptionally well executed HO scale layout. In addition to introducing the hobby to the next generation, NEB&W has also presented both local and general history to non-modelers. The exposure throughout the past 30 years has been far reaching. More than 100 articles about the NEB&W have appeared in various hobby magazines. In 1989 Nehrich and the layout were featured on the NBC Today Show. The NEB&W layout was featured in an article in the Los Angeles Times that was syndicated to 600 other newspapers. The club appeared in *Invention & Technology Magazine* in 1995, and on several local PBS documentary programs. The layout and local historical research by the club was an important part of developing the 2008 film *Sittin' On A Million*. RPI has recently announced plans to renovate Davison Hall dormitory where the NEB&W layout has been housed for some 40 years. At press time, the future of NEB&W remained uncertain. For a virtual tour of NEB&W visit my.matterport.com/show/?m=e6d8iA5vGQ5 ...

Joe Ambrose 1957-2019



Joseph M. Ambrose, president and chief executive officer of Horizon Hobby, died suddenly January 4, 2019. He was 61 years of age. A native of Illinois, Ambrose earned a BS in finance at the University of Illinois, an MBA at Northwestern, and a law degree from Indiana University. He joined Horizon Hobby in 2005 as vice president of distribution. In 2008, he was named president and CEO. In addition to his wife Julie, Joe Ambrose is survived by four children and eight grandchildren ...

Shirlee English 1920-2018



Shirlee C. English, co-founder of English's Model Railroad Supply, has died at the age of 98. The name of the family business was changed to Bowser Manufacturing following the acquisition of Bowser of Riverside in 1961. Until recent years, Mrs. English remained active in the Montoursville, PA business, waving to neighbors

as she commuted to work on her large yellow tricycle. She is survived by four children, including her son Lee who has managed Bowser for more than a decade ...

NEW CLUB CARS



The Chicago North Western Historical Society is selling HO scale kits for a C&NW yellow PS-2 4750 cu. ft. covered hopper

car. Beginning in 1984, C&NW began applying yellow safety paint to various freight cars including a group of 50 4750 cu. ft. covered hoppers built by Pullman-Standard. A distinguishing feature of the new decoration was the use of the black system herald rather than the road's traditional multicolored scheme. CNWHS is offering HO versions of the PS-2 cars in three road numbers: No. 182324 (built 5/1981, repainted 10/4/1984), No. 753667 (built 12/1975, repainted 10/26/1984), and No. 173819 (built 12/1975, repainted in 12/26/1984). The custom models were prepared for CNWHS by Accurail. For ordering information go to cnwhs.org and click on CNWHS Store.

NEW PRODUCTS FOR ALL SCALES



Crow River Products offers a wide selection of cast pewter and resin detail items including this clam-shell bucket that can be positioned either closed or open. Also available is a vertical boiler that measures 2.25-inches high. It is suitable for HO or S scale scenes or as a small O scale

boiler. For a complete list of available details visit crowriver-products.com.



The East Penn Traction Club is selling a 2019 calendar that features a full-color cover photo and 13 high quality B&W photos of trolley lines. To order a calendar send a check or money order for \$12 payable to East Penn Traction Club to East

Penn Traction Club, c/o Charles Long, 227 Locust Road, Fort Washington, PA 19034-1425.

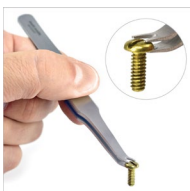

Micro-Mark is selling a specialized tweezer for holding small screws. The tweezer incorporates a notched, angled V-end that securely grips ultra-small screws. It is designed to work with fillister, pan, flat, hex, oval, button, and round head screws. For details visit micromark.com.

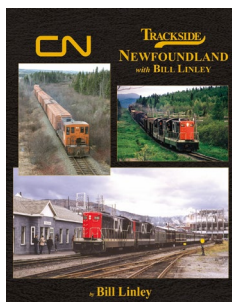
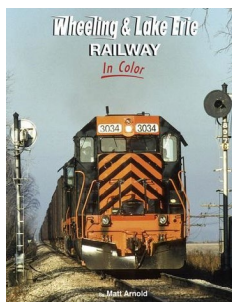

New hard cover books coming from **Morning Sun Publications** include *Wheeling & Lake Erie Railway in Color* by Matt Arnold. W&LE rostered EMD-built locomotives exclusively with the majority painted in a

Rio-Grande-inspired scheme. Scheduled for release next month is *Trackside Around Newfoundland* by life-long Canadian railway photographer Bill Linley. In addition to both standard and narrow gauge locomotives and rolling stock, Linley records the railway ferries and coastal boats of the Canadian province. For additional information contact a dealer or visit morningsunbooks.com.

.....

O SCALE PRODUCT NEWS



Atlas O has scheduled the release of a new production run of 5161 cu. ft. triple-bay covered hoppers during the second

quarter of this year. Introduced by Trinity Industries in 1995, more than 27,000 prototype have been built and it is still being produced today. The Atlas Master series O scale model features metal grab irons and corner steps, etched-metal roof walk and safety platforms, and appropriate roller-bearing trucks with rotating axle caps. Road names for the Atlas O ready-to-run model will be Alaska Railroad, Chessie System, Chicago Freight, Conrail, and Southern Pacific.

New products coming from Atlas O during the third quarter of 2019 include this 40-foot 1937 AAR boxcar. The



ready-to-run model will have wire grab irons, an etched-metal running board, and Bettendorf solid-bearing trucks. In addition to the

Southern Pacific scheme shown above, road names will be Chesapeake & Ohio, Great Northern, Ontario Northland, Pittsburgh & Lake Erie, Monon, and Santa Fe (The Scout). An undecorated model will also be available.

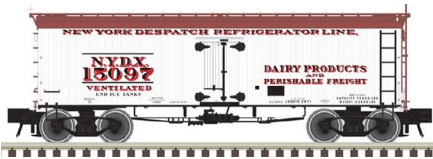

Also scheduled for release during the third quarter of this year is a 36-foot wood ice refrigerator car. The Atlas O Master series model is based on cars

built in 1925 for Cudahy Packing Co. by General American Car Co. The model will have separately-applied grab irons, ladders, stirrup steps, and door hardware. Additional features include 40-ton Bettendorf-style solid-bearing trucks, and doors and hatches that can be positioned open or closed.



Road names will be New York Despatch, Agar Packing, Dold Packing, Lange Creamery, Pittsburgh Provision, Rex Canned Meats (Cudahy),

Schwarzschild & Sutzberger Lard, Nuckoll's Refrigerator Line, and undecorated. The application of truss-rods will be road name specific. Atlas O body-mounted couplers are suitable for both 2-rail and 3-rail equipment. For additional information contact a dealer or visit atlaso.com.

.....

Foothill Model Works has O scale 26-inch wheels cast in high-strength Celcon, a wear resistant acetal copolymer similar to



Delrin. The wheelsets are available gauged for On2, On30, and On3. These are very accurate copies of the single-plate, chilled iron wheels used on the West Side Lumber Co. They are not recom-

mended for use in any truck that uses pointed axles. For details contact info@foothillmodelworks.com.

.....

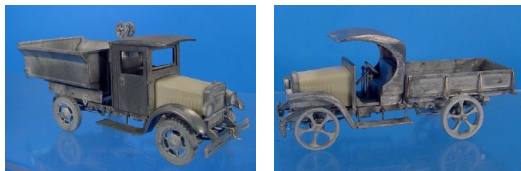

Wiseman Model

Services has several different O scale kits for Kleiber trucks. In addition to a dump truck with a closed cab (above

left), kits are available for a station jitney, and kerosene tank truck. Open-type cabs are available for a pickup (above right), wrecker, stake body, oval tank, flat bed, and semi-truck. The kits are composed of cast white metal and resin parts, assembly drawings and detailed instructions. For additional information visit wisemanmodelservices.com.

.....

HO SCALE PRODUCT NEWS



New HO scale kits released by **Accurail** include two cars decorated for Georgia Railroad. The GR cars are a 36-foot Fowler 2473 cu. ft.

boxcar built in 1914 (above), and a USRA twin-bay hopper car built in 1923 and rebuilt in 1952 (below).

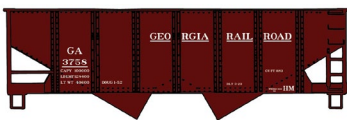

Also new are 40-foot single-sheathed wood boxcars decorated for Nashville, Chattanooga & St. Louis



is also new from Accurail.



(left); and Fort Dodge, Des Moines & Southern. A three-car set of USRA twin-bay hopper cars decorated for Buffalo & Susquehanna

Additional new releases include a Chicago Great Western 40-foot insulated steel plug-door boxcar, an Ann Arbor 36-foot double-sheathed wood boxcar with wood ends, a steel roof, and a fishbelly underframe; a Kansas City Southern Pullman-Standard triple-bay covered hopper, and a Western Maryland 50-foot riveted steel boxcar with double Youngstown sliding doors. All Accurail kits include appropriate trucks and Accumate knuckle couplers. For information contact a dealer or visit accurail.com.



Arrowhead Models has introduced precision machined HO scale wheelsets that feature prototypically contoured inner and outer wheel surfaces. The taper of the axle also follows the prototype. Both wheels and axles are

machined from nickel silver stock. The wheelsets are electrically insulated and meet NMRA standards for Code 88 tread profiles and gauge. Both 33 and 36-inch wheelsets are available. Arrowhead has designed special packaging that protects the axle tips. The wheelsets are sold in 24 packs. For additional information contact a dealer or visit arrowheadmodels.com.

Athearn's newest version of the EMD SD70 series locomotives is the SD70AH. The H suffix designates "heavy" with this series being



ballasted with an additional 8,000 lbs. over the 420,000 lbs. of standard SD70ACe locomotives. Athearn's HO scale version will be available decorated as Union Pacific 9069 and 9096. Features of the Genesis series SD70AH include PTC antenna array, nose-mount headlight, illuminated ditch lights, and late handrails. Delivery is planned for December.



Also scheduled for release late next year is a group of Genesis SD45-2 diesel locomotives. Road names will include locomotives decorated in the Kodachrome scheme of the failed merger of Southern Pacific and Santa Fe, ATSF Bicentennial, Erie Lackawanna, Conrail (ex-EL), Clinchfield, and two versions of CSX; solid gray, and as an ex-CRR in Athearn's Primed for Grime.



Completing the SD45-2 road names is HATX-Helm Leasing which supplied locomotives during peak periods to several eastern roads including CSX and Grand Trunk Western.



Athearn's December production schedule of Genesis locomotives includes GP39X/GP49 models decorated for Southern Railway and Norfolk Southern. Adhering to Southern Railway practice, these units were equipped with 81-inch tall short hoods, control stands set up in the cab for long-hood forward

operation, dynamic brake housing, dual Nathan 5-chime horns, safety lights on the long hood walkway, snowplows fore and aft, and a bell mounted on the long hood. Athearn will produce the same six road numbers decorated for Southern Railway and in the subsequent Norfolk Southern scheme.

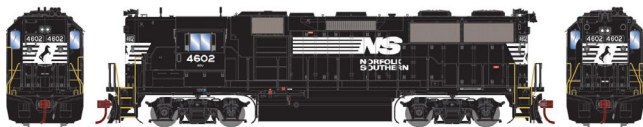

All of the Athearn Genesis locomotives mentioned in this report will

be available for DC operation with a DCC-ready 21-pin NEM socket, and with factory installed Tsunami2 sound and decoder.



R. Bale

GP39X vs GP49

EMD built these six GP39X 2,600 hp units in 1980 as test beds (hence the "X" in their designation) for future medium horsepower locomotives. In 1982, Southern returned them to EMD's La Grange, Illinois plant for mechanical modifications and upgrades that essentially made them true GP49s. The upgrade increased their rating to 2,800 hp, and their designation was officially changed to GP49.



Athearn Ready-to-Roll Husky Stack well cars are scheduled for release next December. The cars will be available in



three-car sets with drawbars included. Like the prototype, the 48-foot well cars can handle 20-foot or 48-foot containers on the bottom, and containers up to 53- feet long on top.



Road names will be BNSF in red and in Primed-for Grime, CSX Intermodal, TrailerTrain, and Southern Pacific.



Athearn's December 2019 release will include three-packs of 40-foot low-cube containers. This is a new model for Athearn that features individual door

locking rods. Carrier names will be China Shipping, CMA/CGM, Maersk Matson, OOCL, and Xines.



HO scale 53-foot reefer trailers are included on Athearn's late

2019 production schedule. The fully assembled models feature separately applied mud flaps and rubber tires. Additional features, depending on the practice of the prototype carrier, include a spare tire rack and three different fuel tank sizes. Carrier names will be Marten, Prime Inc., Motor Cargo, Burlington Northern Santa Fe, Central, KLM, and Stevens. An unlettered owner-operator version will also be available.

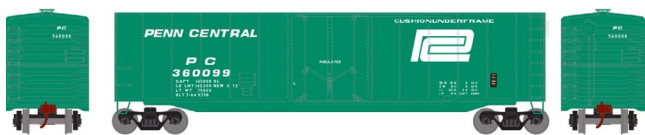

Roundhouse brand models coming from

Athearn next December include a 50-foot smooth side boxcar with plug doors. Identifying features include smooth sides and Dreadnaught ends. In addition to the PC car (lettering diagram shown), road names will be Lehigh Valley, Chesapeake & Ohio, Milwaukee Road, Texas & Pacific, and Western Pacific.



The release includes a car decorated for ATSF Rail-O-Gram, a

unique prototype prepared by Santa Fe that was subsequently signed by many people in support of the SPSF merger proposal. Despite the lobbying effort by many factions, the merger was subsequently denied by the ICC. For information on all Athearn and Roundhouse products contact a dealer or visit athearn.com.

.....



Atlas has announced a new release of the Alco C424/C425 in their Classic line. Part of Alco's Century

series of locomotives, the C424/C425 featured the 16-251 prime mover at 2400 and 2500hp respectively. Phase 1 C424 road names include Erie Lackawanna, Green Bay & Western, and undecorated. Phase 2 C424 road names are Delaware-Lackawanna, Green Bay & Western, Minnesota Commercial, Morristown & Erie, and undecorated. Phase 2 C425 road names are BC Rail, Delaware-Lackawanna, and undecorated. Both DC with an 8-pin DCC plug and DCC sound with an ESU Loksound Select Dual-mode decoder will be available.

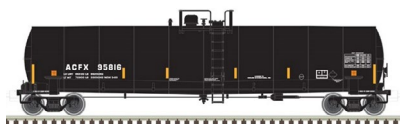

Atlas is planning to release an HO scale ACF 23,500 gallon tank car during the third quarter of this

year. The ready-to-run model is based on a general-purpose, single-compartment, insulated, non-pressurized tank car built by ACF Industries. The prototype cars are used to transport a wide range of commodities including asphalt, ethanol, fuel oil, metal sodium, molten phenol, paraffin wax, tallow, urethane polyol, and vegetable oil. Like the prototype, Atlas's Master series model rides on 100-ton roller-bearing trucks. Road names on this release will be ACFX-Asphalt, ACFX- Edible Lard, ACFX-Inedible Tallow (above), AMOX-Amoco, CHVX-Chevron, PTLX-Pullman Transport, SCMX-Shell, and TILX-Trinity Industries. An undecorated car will also be available.



Atlas's third quarter release will include this Master series ACF 89-foot 4-inch flat car. Atlas's HO scale model is based on a 1973 prototype designed to carry two trailers or combinations with containers. The cars were used in intermodal service by several railroads including Trailer Train. Many of the cars were modified to handle longer trailers. Most that remain in service today have received three hitches to accommodate up to three shorter package trailers. Road names on Atlas's ready-to-run model will be HTTX (Penny Heritage scheme), and Florida East Coast. Undecorated models equipped for containers, and with middle and end hitches will also be in the third quarter release. For more information contact a dealer or visit atlasrr.com.



Bowser has scheduled a mid-summer release for a group of HO scale 40-foot Pennsylvania X31 boxcars.

The ready-to-run models will be available in several combinations of door and round roof configurations. X31 cars with double doors and roofs with flush eaves will be available decorated for Northern Pacific, Detroit, Toledo & Ironton, PRR (shadow keystone), and Seaboard (Orange Blossom Special). A flush roof car with single doors will be available decorated for Seaboard with a Silver Meteor herald.



PRR X31b boxcars with inset roof eaves and double doors for automobile service will be available with a circle keystone herald. The same car will also be available with a “Buy War Bonds” slogan.



Bowser’s production schedule includes two PRR X31 boxcars with single doors and inset eaves. One will show a circle keystone herald while the other car, assigned to stores service, will display a framed S on the left side of the car and a large plain keystone herald on the right.

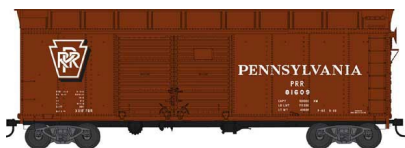

Two PRR X31f boxcars with turtle roofs and double doors are included in the release. One will have a circle keystone with the second car decorated with a large shadow keystone herald.



Completing the summer release are two K11 series PRR stock cars with one having a silver roof and doors.

All Bowser HO scale ready-to-run models come with knuckle couplers and appropriate cast Delrin trucks fitted with metal wheelsets. For additional information contact a dealer or visit bowser-trains.com.

.....



R. Bale

THE PENNSYLVANIA RAILROAD

The Pennsylvania Railroad developed the round-roof X-31 to increase the cubic capacity of standard 40-foot boxcars. Other than some difficulties with the eaves that prompted several different designs, the X-31 was considered a great success with the "P" Company eventually acquiring more than 12,500 of them between 1932 and the late 1930s. Production included 50-foot X-31 boxcars with the same round roof.



Funaro & Camerlengo has an HO scale resin kit for a Seley twin-bay composite hopper car. The craftsman kit features a one-piece body with interior detail. Accurate

Delaware & Hudson decals and step-by-step instructions are included in the kit, which is sold without trucks or couplers. For additional information visit fandckits.com.

.....



InterMountain Railway is accepting advance reservations until February 28 for a new production run of HO

scale drop bottom gondolas. Several versions of the

ready-to-run model will be available including steel and composite sides and extended sides for beet or wood chip service. A car with steel sides will be available decorated for Denver & Rio Grande Western, Northern Pacific, Great Northern, Union Pacific, and Southern Pacific with Roman lettering (above) and in a 1958 repaint scheme with block lettering (below).



A Southern Pacific beet service car that combines Roman lettering on the composite body and block lettering on the steel extended sides is included in the run.



A composite car with wood extensions for chip service will be available for Southern Pacific, Western Pacific, and Spokane,

Portland & Seattle. Delivery is planned for late this year. For information on all InterMountain Railway products contact a dealer or visit intermountain-railway.com.



Broadway Limited Imports has a new production run of Union Pacific 4-8-8-4 Big Boy steam

locomotives. The HO scale die cast model is equipped with traction tires. It comes with Paragon3 Rolling Thunder sound that functions in both DC and DCC environments. Two versions of the prototype with 25-C-100 coal tenders are available; a 1941 version and a 1944 version with a Wilson aftercooler. Also available is No. 4014, a modern excursion version equipped with an oil tender. For more information contact a dealer or visit broadway-limited.com.

.....



The Electric Wallpaper Co. will introduce its first product, Roomettes interiors,

at the Amherst Railway Society Railway Hobby Show in West Springfield, MA on January 26. The initial offering of 10 different kits sized to fit Woodland Scenics and DPM HO scale structures assemble into 3D interiors and include LEDs that are plug compatible with Woodland Scenics Just-Plug and NCE lighting systems. Roomettes will be available through www.roomettes-lighting.com in early February 2019.

.....



Kadee plans to release an HO scale model of this 40-foot Southern Railway boxcar this month. The ready-to-run model replicates 1948 Pullman

Standard production with 10-panel welded sides fitted with seven panel six-foot Superior doors.



Also due from Kadee later this month is a 50-foot Grand Trunk Western PS-1 boxcar with 10-foot Youngstown sliding doors.

Kadee's HO scale model represents a 1970-era car that received a cushion underframe when it was rebuilt and repainted in November 1990.



New Kadee models scheduled for release in March include an HO scale version of this 40-foot Seaboard Air Line PS-1 boxcar. The 10-panel welded sides,

narrow bolster tabs, and 8-foot Youngstown sliding doors match a prototype built in 1951.



Completing Kadee's March release of new HO scale ready-to-run models is an ACF 11,000 gallon insulated tank car decorated for PBGX-Protane Bottled Gas.

The model is based on a prototype built in 1947 with a full loading platform. All Kadee HO models come with Kadee couplers and two-piece self-centering trucks. For additional information contact a dealer or visit kadee.com.



Owl Mountain Models is selling a kit (OMM #10002) to create a Pyle Gyalite Tailgate Marker. The easily-assembled kit is designed to fit most HO scale passenger cars. It will function on layouts using either DC or

DCC power. The kit provides material for two cars. Components include two tailgates, two Gyalite housings, two small red LEDs, and two ¼ watt 1000 ohm dropping resistors. For additional information, including notes on prototypical use and suggestions for adapting the kit to various brands of passenger cars, visit owlmt-models.com.

.....



Rapido Trains has announced plans to produce three new HO scale locomotives, including two steam engines. Tentatively scheduled for release in 2020 is a Canadian National class H-6-d/g 4-6-0 Ten Wheeler. The light, general-purpose locomotive handled both freight and passenger assignments across the entire CNR system. They lasted in regular service into the late 1950s with several being preserved after the end of steam.

Through their years of service, the prototype locomotives received numerous alterations. Rapido will offer these variations which include oil or coal tenders (with and without extended bunker), wood or steel cabs, manual or power reversers, vertical or horizontal slat pilots, and variations in headlight sizes and bell location.



Through their years of service, the prototype locomotives received numerous alterations.

Rapido will offer these variations which include oil or coal tenders (with and without extended bunker), wood or steel cabs, manual or power reversers, vertical or horizontal slat pilots, and variations in headlight sizes and bell location.



The CNR H-6 will be available with a level or tilted herald on the tender, plus two painted but unlettered variations.

but unlettered variations.

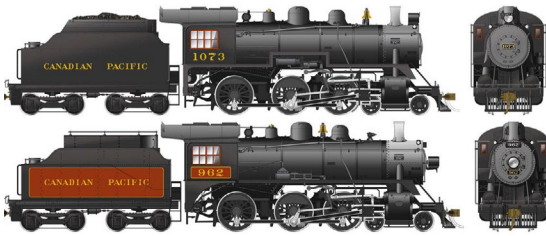

being built between 1905 and 1913. Many lasted until the end of steam service in 1961.

Rapido will offer variations in detail to cover the changes applied to CPR D10s over the course of their long life. These include coal or oil tenders, raised or straight walkways, angled or straight front number boards, two styles of power reversers, and variations in the location of headlights and bells.

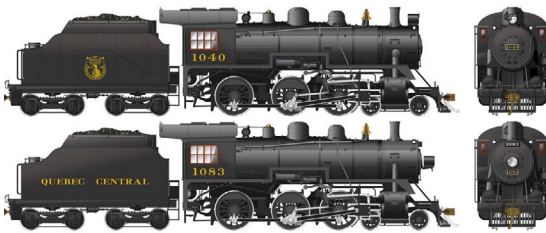

Central, and painted but unlettered. A custom paint scheme will be available exclusively through Credit Valley Railway Co.

Both of Rapido's new HO scale steam locomotive models will feature special lighting effects for the headlight, marker lights, number boards and a flickering firebox. They will be available for standard DC operation without sound, and with DCC sound and decoder. The order deadline is October 14, 2019, with delivery planned for 2020.

For Canadian Pacific modelers, Rapido will offer a D10 Class 4-6-0 Ten Wheeler. CPR's D10 was the most numerous class of steam locomotive in Canada with 502

Decorating schemes for Rapido's D10 will be Canadian Pacific, Canadian Pacific (passenger), Dominion Atlantic, Quebec



Following the strong sales of their HO scale GMD (Canadian built) SW1200RS diesel locomotive, Rapido has decided to offer an EMD (American built) SW1200.

Introduced in early 1954, the SW1200 provided railroads with a compact, lightweight locomotive to replace steam power on branch lines that did not require the muscle of a full-fledged main-line road engine.

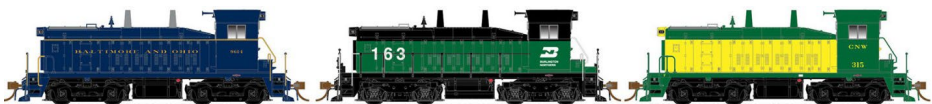

Rapido will offer the SW1200 in a variety of road-specific details including Type A and Flexicoil trucks, different fuel tanks, spark arrestors, MU cables, folding end platform, step configurations and different lighting options.



The SW1200 will be available in the following road names plus three undecorated versions: Baltimore & Ohio, Burlington Northern (ex-GN), Chicago, Burlington & Quincy; Chicago, Rock Island & Pacific; Conrail (ex-PRR), Denver & Rio Grande Western, Grand Trunk Western, Great Northern, Milwaukee Road, Missouri Pacific, New Haven, Northern Pacific, Pennsylvania, Penn Central (ex-NH), Soo Line, and Southern Pacific.



Rapido's HO scale SW1200 will be available for standard DC operation without sound, and with an ESU LokSound decoder utilizing recording from a prototype 567 prime mover. The

order deadline is October 14, 2019, with delivery planned for 2020. For additional information contact a dealer or visit rapidoctrains.com.

.....



Resin Car Works has released an HO scale kit for a 1937 Great Northern wood-sheathed boxcar. This is an updated one-piece body version of a similar kit offered many years ago by Sunshine Models. The RCW update

includes a correct underframe, a new roof, and a pair of Tahoe Buckeye ARA 50-ton truck side frames. Ted Culotta created the artwork for the GN decals included with this kit. For additional information visit resincarworks.com.

.....



As mentioned last month in our Briefly Noted report, **Walthers** has announced plans to produce an SD70ACe diesel decorated for Union Pacific No. 4141

George H.W. Bush. The Mainline series model is scheduled for release in December. Features include directional LED lighting, working ditch lights, and the same drive system as WalthersProto models. Drill starter points are molded in the body to indicate where grab irons can be added using the Walthers SD70ACe detail kit which is sold separately. No. 4141 will be available for DC operation as well as with ESU Sound and DCC decoder. Walthers states the HO scale locomotive will operate on an 18-inch radius but recommends a 22-inch or larger radius.



Yellow and gray Heritage Fleet scheme. They include a baggage car displaying an American flag, a dome diner, and a 48-seat diner (below).



is scheduled for release in late April. Walthers HO scale Mainline series model is based on prototypes in service from late 1960s to the present. Matching racks and bulkheads to convert the open car to coil steel or pulpwood service are included. The model comes with metal knuckle couplers and 36-inch machined metal wheelsets.



Southern, Penn Central, Wisconsin Central, and Milwaukee Road.

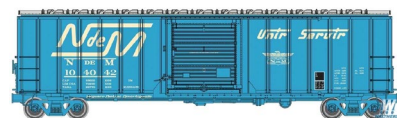

The release of UP No. 4141 will be accompanied by six 85-foot ACF smooth-side passenger cars decorated in Union Pacific's Armour

Completing this release of Union Pacific Heritage Fleet equipment are three dome lounge cars decorated for City of San Francisco (above), Harriman, and Walter Dean.

A new production run of a 53-foot Thrall gondola with smooth side panels

Road names will be Denver & Rio Grande Western, Conrail, Norfolk

Walthers is quoting an August release date for a group of 50-foot ACF exterior-post boxcars. The Mainline series model is based on

a 1970s-era Plate B prototype that is 15-feet 2-inches tall and 10-feet 8-inches wide. In addition to the National Railways of Mexico car shown above, road names will be Burlington Northern, CSX Transportation, Railbox, and Boston & Maine.



The ready-to-run model comes with metal knuckle couplers and appropriate trucks with 33-inch machined metal wheelsets.



New Walthers Cornerstone items include a kit for an

ornate wrought iron fence. Sufficient material is included to build an HO scale fence 25.5-inches long. A matching gate, cut-stone supports, and 12 each of three sizes of nonworking lamps are included. For additional information on Walthers products contact a dealer or visit walthers.com.

N SCALE PRODUCT NEWS



Athearn's
December 2019
production schedule for N scale

products includes 50-foot PS-1 boxcars with plug doors, Pullman-Standard corrugated steel ends and a bow-tie patterned metal roof. In addition to the Milwaukee Road car shown, road names will be Penn Central, Lehigh Valley, Chesapeake & Ohio, Texas & Pacific, and Western Pacific.



The N scale release includes a car decorated for

ATSF Rail-O-Gram, a unique prototype prepared by Santa Fe that was subsequently signed by many people in support of the proposed SPSF merger proposal. Despite the lobbying effort by many factions, the merger was subsequently denied by the ICC. For information on all Athearn products contact a dealer or visit athearn.com.

.....

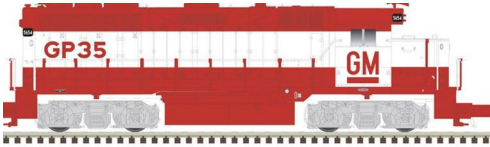

Atlas has announced a new release of the EMD GP35 locomotive in the Classic line. The ultimate 4-axle locomotive in the 567 prime

mover line, the GP 35 introduced a new squared-off cab style. Roadnames in this release include ATSF, Canadian Pacific, EMD Demonstrator, Gulf Mobile & Ohio, Illinois Central Gulf, Penn Central, Seaboard Coast Line, and Union Pacific. The models will be available both in DC only and DCC with sound from ESU.

Atlas plans to introduce a new N scale model of a 4180 cu. ft. Airslide covered hopper during the third quarter of 2019. The new ready-to-run model will be available decorated for Frisco, Gulf, Mobile & Ohio; Rock Island, Southern Railway, and Westvaco. An undecorated model will also be released.



A second new N scale covered hopper is also scheduled for release by Atlas during the third quarter. The Atlas Master series model

is based on a low-side 4427 cu. ft. triple-bay covered hopper introduced by Pullman-Standard in the mid-1950s. Road names on this initial release will be Illinois Central Gulf, Chessie, Canadian National, Santa Fe (Q herald), and Union Pacific. Atlas will also release an undecorated version.



Completing the list of new N scale models Atlas has set for release during the third quarter is a GSI bulkhead flat car with an interior length of 48-feet. General Steel Industries developed the prototype for this model in the 1960s. Atlas's N scale version has a heavy die-cast body and intricate detail on the bulkhead lattices.



Road names for the Master series model will include Burlington Northern, Frisco, Northern Pacific, Soo Line, Union Pacific, and an undecorated model. For additional information contact a dealer or visit atlasrr.com.

.....



Jacksonville Terminal Company has released more 40-foot HC corrugated-side containers. The shipping companies included in this release include Gateway Container, Zim, MAERSK and GE SEACO. For more information see your dealer or jtcmodeltrains.com.

.....



KatoUSA plans to release N scale models of Amtrak's new single-level Viewliner II in June. The cars will feature all metal wheel pickup as well as interior lighting capability using Kato's 11-211 or 11-212 Version 2 Interior Lighting Kits.



In conjunction with Kato's re-issue of Union Pacific SD70ACe No. 4141 George Bush (see MRH January 2019 for details), the company will also re-release its seven-car UP Excursion Train.



The seven car consist includes power car No. 207, Budd 10-6 sleeper No. 202, museum car Promontory (above), dome coach Columbine, coach Portland Rose,

dome diner City of Portland (below), and business car No. 119 Kenefick. Availability is planned for July.



The excursion train set will also be available with factory installed interior lighting.



KatoUSA has several N scale freight train starter sets that include an F7 locomotive plus an assortment of freight cars. The sets include an AT&SF red and silver Warbonnet locomotive with two 70-ton covered hopper cars, a UTLX tank car, and a caboose. Similar sets are available with a Santa Fe Bluebonnet F7 (above) and a Union

Pacific F7 diesel locomotive. The sets are available with locomotives ready for DC operation, DCC or ESU LokSound DCC. Track

and power are not included in these sets. For additional information contact a dealer or visit katousa.com.



Heading the list of new cars is a 56-foot general service frame-less tank car decorated for Procor. The model rides on Barber roller-bearing trucks.



Also new is a 50-foot Chesapeake & Ohio boxcar with double 8-foot sliding doors that are equipped with a Slidewell rack and pinion door opening mechanism manufactured by Hennesy Company. The N scale model follows a prototype built in 1955 by American Car and Foundry. The model features a new lowered underframe and body-mount couplers.



Micro-Trains is selling a wood sided ice reefer from the truss-rod era that is decorated for Heinz 57 Varieties. The Heinz Company introduced the “57 Varieties” slogan in 1896 and applied it to its entire fleet of 700 billboard reefers. Each car featured different products, in this case pickles, figs and onions. This is the first in a series of Heinz cars Micro-Trains plans to release.



A 40-foot ATSF class Bx-78 boxcar completes this month’s list of new N scale models from Micro-Trains.

The model is based on a 1944 prototype that was rebuilt in the 1950s with a cushioned underframe that Santa Fe's marketing department called "Shock Control." The eye-catching paint scheme includes black ends and roof, and red sides with a large circle cross Santa Fe herald. For additional information on Micro-Trains models contact a dealer or visit micro-trains.com.

.....



ScaleTrains.com has released an N scale version of a Gunderson 5188 cu. ft. triple-bay covered hopper car. The ready-to-run model features photo-

etched stainless steel see-through roof walk and end platforms, metal grab irons, plastic semi-scale Type E lower knuckle couplers, uncoupling levers, trainline hoses, and ASF Ride Control trucks.



The Rivet Counter series model is available decorated for Kansas City Southern, AOK, BNSF, CMO/Building America, and Union Pacific. For additional information visit scaletrains.com.

.....



THE LIMITED MODELER
Jim Six: The secret to staying motivated

Buy Issue: \$1.99 >>

In **MRH** **RUNNING** **EXTRA**

A yellow rectangular box containing a photo of a man in a yellow jacket holding a model train. Below the photo is the text 'THE LIMITED MODELER Jim Six: The secret to staying motivated'. Below that is a dark red button with white text 'Buy Issue: \$1.99 >>'. At the bottom is the logo 'In MRH RUNNING EXTRA'.

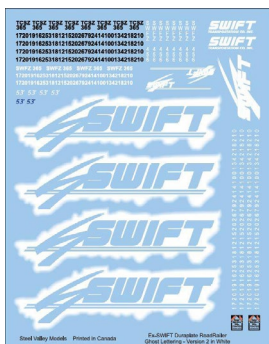

Roadrailers that were purchased by TCS. For more information go to Steel Valley Models's Facebook page at www.facebook.com/pg/SVMHopperTopper/photos/?tab=album&album_id=2130981513590635.



SEND US YOUR PRODUCT ANNOUNCEMENTS

If you are a hobby manufacturer with a product announcement, just [click here](#) and submit your announcement to us. Our web site and free magazine reach continues to grow, so get on board this new media train! ■



RATE THIS ARTICLE

DISCLAIMER

The opinions expressed in this column are those of the writer and do not necessarily reflect the opinion of *Model Railroad Hobbyist* or its sponsors. Every effort is made to provide our readers with accurate and responsible news and information, however, neither *Model Railroad Hobbyist* or the writer of this column can be held responsible for any inaccuracies or typographical errors that may inadvertently appear in this column.

Use our custom Google search on the MRH website to find topics of interest

Click to find out more

DOWNLOAD ISSUE



DOWNLOAD PORTRAIT



DOWNLOAD LANDSCAPE



UPGRADE YOUR LOCO FLEET
Tony Thompson on getting a
more realistic loco fleet

Buy Issue: \$1.99 >>

In **MRH** **RUNNING**
EXTRA



**CANADIAN
NATIONAL**

CANADIAN NATIONAL RAILWAYS Class H-6-d/g

IN HO SCALE

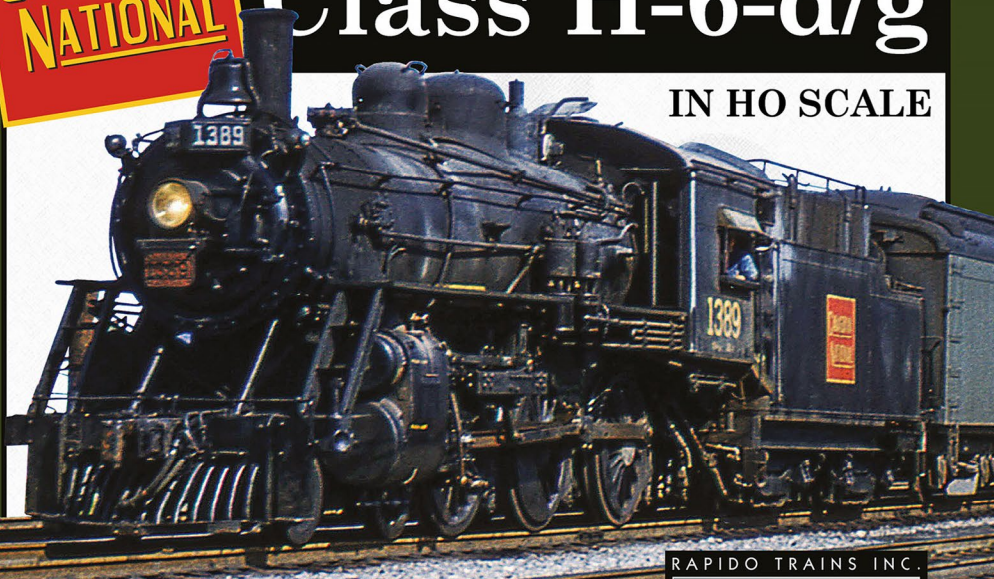

**INTRODUCING THE FIRST CNR
LOCOMOTIVE IN THE ICONS
OF CANADIAN STEAM SERIES**

WITH THREE TENDER STYLES

STANDARD COAL

EXTENDED
COAL

OIL



**CLICK
HERE**

RAPIDOTRAINS.COM

RAPIDO TRAINS INC.

ICONS

OF
CANADIAN
STEAM

HO SCALE



PHOTOS COURTESY JOHN RIDDELL



BRIEFLY NOTED AT PRESS TIME ...

Accurail's next release of new HO scale kits will include a 36-foot Fowler wood boxcar decorated for Chicago, South Shore & South Bend. ...

Bowser has reintroduced HO scale Kiesel rigid tender trucks and Buckeye 3-axle tender trucks with 36-inch wheelsets. Retainers and retainer mounting screws are included...

Following a series of successful field tests, **Eastern Seaboard Models expects** to have production quantities of N scale ASF Ride-Control 70-ton trucks with 33-inch fine scale metal wheels sometime in April ...

Walthers will introduce a new line of HO scale track in April. Code 83 and code 100 36-inch track sections, and DCC friendly #4, #5, and # 6 turnouts will be available. The new track is said to be compatible with Shinohara and Walthers original track ...

Exact Rail has HO scale Platinum Series Thrall 3564 cu. ft. gondolas decorated for MHFX, Canadian Pacific, LW, and Southern Pacific ...

Morning Sun Books has released Volume 4 of *Erie Railroad Official Photography* by Daniel G. Biernacki ...



You're the kid.



Welcome to the candy store.

July 12-14, 2019

**Mountain America
Exposition Center
Salt Lake City, Utah**

For more information,
click here to visit:

NationalTrainShow.org

**CLICK HERE
FOR ALL THE
DETAILS!**

www.nationaltrainshow.org

Sponsored by



We make it more fun!

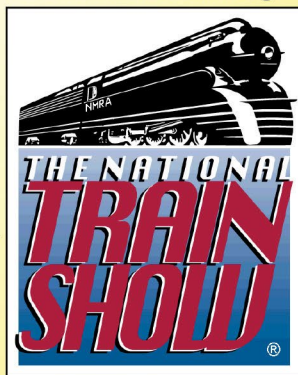

SELECTED EVENTS



Model Railroad Hobbyist | February 2019 | #108

FEBRUARY 2019

(Many events charge a fee. Check individual info website for details.)

CALIFORNIA, BUENA PARK, February 10, California Express Railroadiana Show, at Buena Park Holiday Inn. Info at www.facebook.com/calexpressbuenapark.

KANSAS, WICHITA, February 2-3, The BEST Train Show, sponsored by NMRA Chisholm Train Division at Cessna Activity Center 2744 George Washington Blvd. Info at besttrainshow.com.

MASSACHUSETTS, AUBURN, February 24, Greater Worcester Model Train Show, at Auburn Elks Club, 754 Southbridge Street (Route 12). Info at wmrr.org.

OREGON, PORTLAND, February 9, Second Annual Portland Railroad Prototype Modelers Meet, Shilo Inn & Suites, 11707 NE Airport Way. Info at www.brpmm.com.

SOUTH CAROLINA, EASLEY, February 8-9, Model Train Expo, sponsored by Central Railway Model and Historical Association, at Rock Springs Church, 207 Rock Spring Road. Info at crmha.org.

TEXAS, STAFFORD (Metro Houston), February 16, Greater Houston Train Show, sponsored by San Jacinto Model Railroad Club at Stafford Centre, 10505 Cash Road. Info at sanjacmodeltrains.org.

WISCONSIN, MADISON, February 16-17, Mad City Model Railroad Show & Sale sponsored by NMRA South Central Wisconsin Division, at Exhibition Hall, Alliant Energy Center. Info at nmra-scwd.org.

WISCONSIN, STEVENS POINT, February 2-3, 22nd Artic Run Model Railroad Show & Sale, sponsored by Central Wisconsin Model Railroaders Ltd, at Stevens Point Holiday Inn and Convention Center, 1001 Amber Avenue. Request info from Jim Miller at jimbro67@gmail.com.

March 2019, by location

AUSTRALIA, CANBERRA, KALEEN, March 30-31, 31st Annual CMRCI Model Railway Expo, sponsored by Canberra Model Railway Club, at UC High School, Baldwin Drive. For details phone Anthony Hunt at +61 0414 730 824.

CANADA, ONTARIO, KINGSTON, March 10, 30th Annual Rail O Rama Model Train Show, sponsored by Canadian Railroad Historical Association, at Ambassador Hotel, 1550 Princess Street. Request info from Graham Oberst at graham.oberst@bell.net.

CANADA, ONTARIO, TORONTO, March 16, Railway Prototype Modellers Meet, at Humber College, 205 Humber College Blvd, North Campus, Building B, Rooms B201 & B202. Info at torontoprototypemodellers.wordpress.com.

CALIFORNIA, BAKERSFIELD, March 9-10, 26th Annual Model Railroad Show & Sale, at Kern County Fairgrounds, 1142 South P Street. Info at gehams.club.

KENTUCKY, LOUISVILLE, March 23, 29th Annual Train Show & Sale, sponsored by NMRA Division 8 Mid Central Region, at Moose Lodge, 4615 Fegenbush Lane. Info at www.div8-mcr-nmra.org.

MISSOURI, SPRINGFIELD, March 23, 39th Annual Model Train/Swap Show, at Expo Center, 635 St. Louis Street. Info at omraspringfield.org.

NEW YORK, BATAVIA, March 31, Great Batavia Train Show, sponsored by Genesee Society of Model Engineers, at Richard C. Call Arena, Genesee Community College. Info at www.gsme.org.

OHIO, GREENVILLE, March 3, 38th Annual Model Railroad Swap Meet, sponsored by the Darke County Model Railroad Club at Youth Building, County Fairgrounds, 800 Sweitzer Street. Request info from Joe Worz at josephbw@hughes.net.

OHIO, KIRTLAND, March 16-17, Railfest Train Show, sponsored by NMRA Western Reserve Division 5, at Lakeland Community College, 7700 Clocktower Drive. Info at railfest.org.

OREGON, ELSIE, March 2, 15th Annual Pacific Model Loggers' Congress, at Camp 18 Restaurant & Logging Museum, 42362 Highway 26. Info at www.pacificmodelloggerscongress.com.

OREGON, PORTLAND, March 9, 34th Annual Swap Meet sponsored by Willamette Model Railroad Club at WD Jackson Armory, 6255 Northeast Cornfoot Road. Info at www.facebook.com/events/1303189686489326.

PENNSYLVANIA, GREENSBURG (Metro Pittsburgh), March 22-23, 2019 RPM East, sponsored by NMRA Division Two, at Ramada Greensburg Hotel and Conference Center, 100 Sheraton Drive. Info at hansmanns.org/rpm_east/index.htm.

VERMONT, ST. ALBANS, March 9, Vermont Rails Model Railroad Show, sponsored by Northwestern Vermont Model Railroad Association, at Collins Perley Sports & fitness Center. Info at nvwrailroad.org.

Future 2019, by location

CANADA, BRITISH COLUMBIA, BURNABY, May 3-5, Railway Modelers Meet of BC, at Simon Fraser University, Burnaby Campus, West Mall Centre. Info at railwaymodellermeeetofbc.ca.

CALIFORNIA, SAN BERNARDINO, April 27, Western Prototype Modelers Meet, at San Bernardino Train Depot, 1170 West 3rd Street. Info at ppw-aline.com/pages/railroad-prototype-modelers.

ILLINOIS, COLLINSVILLE (metro St Louis), July 26-27, St. Louis RPM Meet, at Gateway Convention Centre. Info at icg.home.mindspring.com/rpm/stlrpm.htm.

INDIANA, INDIANAPOLIS, April 13, Indianapolis Spring Train Show sponsored by NMRA Central Indiana Division at Manual High School Gym, 2405 S. Madison Avenue. Info at cidnmra.org.

MICHIGAN, WYOMING, April 13, Spring Train Show, sponsored by Grand River Valley Railroad Club at 5625 Burlingame Ave SW. Info at grvrrc.org.

OREGON, PORTLAND, August 27-31, 35th National Garden Railway Convention, hosted by Rose City Garden Railway Society, at DoubleTree by Hilton Hotel, 1000 NE Multnomah Street. Info at www.ngrc2019.org.

TENNESSEE, JOHNSON CITY, May 31 – June 1, Scale Model Train Show & Sale, sponsored by Mountain Empire Model Railroaders, at George L. Carter Railroad Museum, East Tennessee State University. Info at memrr.org.

TEXAS, FRISCO, June 27-30, 2019 Texas Special NMRA Lone Star Region Convention, at Drury Inn & Suites, 2880 Dallas Parkway. Info at www.2019TexasSpecial.com.

UTAH, SALT LAKE CITY, July 7-13, 2019 NMRA National Convention and National Train Show. HQ at Little America Hotel. Info at nmra2019slc.org.

Beyond 2019, by location

MISSOURI, ST. LOUIS, July 12-18, 2020, NMRA National Convention and National Train Show. HQ at Hilton St. Louis at the Ballpark. Info at gateway2020.org.

CALIFORNIA, SANTA CLARA, 2021, NMRA National Convention and National Train Show.

ENGLAND, BIRMINGHAM, 2022, NMRA National Convention and National Train Show. ■

DERAILMENTS



RATE THIS ARTICLE

Model Railroad Hobbyist | February 2019 | #108

**THE BABOON
THAT RAN A RAILWAY**

[click to play video](#)

[YouTube](#)

Jack the Baboon railroad signalman

It was in the late 1800s when travellers to Cape Town in South Africa encountered a most unusual worker at Uitenhage train station! Operating the levers in the interlocking tower was a baboon named Jack. You read right, he worked as the local signal baboon – and apparently was quite good at it. ■



▶ BIZARRE FACTS AND HUMOR (SUPPOSEDLY)

CLICKABLE ADVERTISER INDEX

[Accu-Lites](#)
[Archer Fine Transfers](#)
[Athearn](#)
[Atlas Model Railroad Co.](#)
[Bachmann](#)
[Backdrop Junction](#)
[Berrett Hill Trains](#)
[Black Cat Publishing](#)
[Blair Line](#)
[Bowser](#)
[Caboose](#)
[Canyon Creek Scenics](#)
[Coffman Graphics](#)
[Crow River Products](#)
[Decal Pro FX](#)
[Digitrax \(2 page spread\)](#)
[El Dorado 3rd PlanIt](#)
[Electric Wallpaper \(Roomettes\)](#)
[ESU LokSound](#)
[Fast Tracks](#)
[Great Decals](#)
[HO Diesel Supply](#)
[Iowa Scaled Engineering \(ISE\)](#)
[Jelsma](#)
[ITLA Scale Models](#)
[Kenpatterson.com](#)
[Lights 4 Models](#)
[Litchfield Station](#)
[Logic Rail Technologies](#)
[Main Street Heritage Models](#)
[Masterpiece Modules](#)
[Micro-Trains Line](#)
[Mike & Scotty Live](#)
[Model Railroad Control Systems](#)
[Modeltech Studios](#)
[Monashee Laser Engineering](#)
[Mountain Subdivision Hobbies](#)

[MRH Store \(1\)](#)
[MRH Store \(2\)](#)
[MRH Store \(3\)](#)
[Mt. Albert Scale Lumber](#)
[National Train Show \(Salt Lake City\)](#)
[NCE \(2 page spread\)](#)
[Norfolk & Western Historical Society](#)
[North American Railcars](#)
[Pre-Size Model Specialities](#)
[Precision Design Co.](#)
[Rapido \(1\)](#)
[Rapido \(2\)](#)
[Ring Engineering \(1\)](#)
[Ring Engineering \(2\)](#)
[Scale Trains](#)
[Soundtraxx \(Blackstone\)](#)
[Southern Digital](#)
[Streamlined Backshop Services](#)
[TAM Valley Depot](#)
[TrainMasters TV](#)
[Walthers](#)
[Westerfield Models](#)
[Yarmouth Model Works](#)

Clickable "other" index

[Other – Contents](#)

[Other – Cover](#)

[Other – Derailments](#)

[Other – MRH Marketplace](#)

[Other – MRH Sponsors](#)

COMING NEXT MONTH IN MRH ...



Lee Nicholas' Utah Colorado Western ...

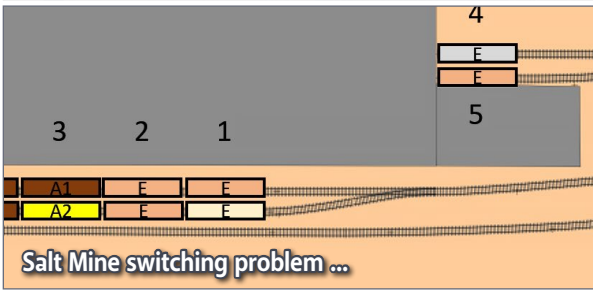

Salt Mine switching problem ...



Model a working rollup door ...

... coming in the
March MRH

COMING NEXT MONTH IN *RUNNING EXTRA* ...

... all the MRH articles and ads, *PLUS*:



Greg Baker on painting figures more realistically ...



Kitbashing two versions of a Southern bay window caboose ...

March 2019 - \$1.99

MRH **RUNNING**
EXTRA
More modeling every month

Lee Nicholas'
Utah Colorado Western
▶ **READ NOW**

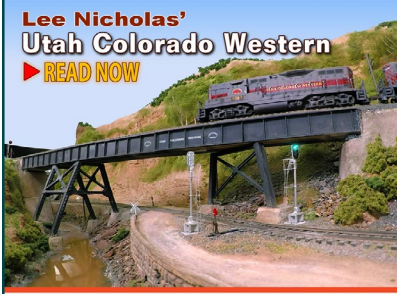

Also these articles:

- Lorem ipsum dolor sit amet
- Consectetur adipiscing elit morbi
- Vestibulum tempus vehicula
- Mauris tempor libero ipsum pellentesque
- Nullam porta ut arcu at lobortis

... and much more!



Build / weather styrene as wood...

... all this and much more!

SUBSCRIBE: 1 YR \$19.99