

HAVING FUN WITH TRAINS

JULY 2018 | FREE

MRH

MODEL RAILROAD HOBBYIST

ALSO:

- Goff Brook farmhouse
- Breaking the rules
- TOMA contest winner
- Building Frisco steam
- End DCC stalls

... and more inside!



**Bob Rivard models
Rock Island U25B #250**

▶ READ NOW

PORTRAIT EDITION



DOWNLOAD



SUBSCRIBE
(free)

Now Available from



ATLAS STANDARD BOX TRAILER W/ SINGLE AXLE



ATLAS MODEL RAILROAD, INC.



POLICE 9-1-1



GREENLAWN



BLUE



ORANGE STRIPE DELIVERY SERVICE



RED



WHITE

FEATURES:

- HO built-up construction
- Movable rear supports-free standing
- Free-rolling wheels
- Trailer tongue with separate ball hitch (can be mounted to a vehicle)
- Painted brake lights, hardware detailing & trim



FOR MORE INFORMATION OR TO LOCATE A DEALER, PLEASE VISIT WWW.ATLASRR.COM.
 ATLAS MODEL RAILROAD CO., INC. • 378 Florence Ave., Hillside, NJ 07205

STAFF CREDITS

HAVING FUN WITH TRAINS

MRH
MODEL RAILROAD HOBBYIST

Model Railroad Hobbyist | July 2018 | #101

(Updated 06/28/18)



RATE THIS ISSUE

ISSN 2152-7423

Editorial Staff



Joe D. Fugate, Publisher and Editor



Patty Fugate, Pasteup and Layout



Richard Bale, News and events



Jeff Shultz, News and events, Tech Assistant

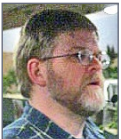

Joe Brugger, Copy Editing



Mike Dodd, Copy Editing

Advertising

Les Halmos, Account Manager

Daniel Nava, Advertising Assistant

Jean-François Delisle, Marketing Assistant

Columnists

Larry Smith, Narrow Gauge/Shortlines

Bruce Petrarca, DCC

Ken Patterson, Reporter at large

Rotating Columnists

Jack Burgess, Getting Real column

Nick Muff, Getting Real column

Mike Rose, Getting Real column

Tony Thompson, Getting Real column

Rob Clark, Imagineering

Dave Meek, Imagineering

Ray Dunakin, Imagineering

Issue password: Jul2018

Published for the glory of God. [What's this?](#)

• [INDEX](#)



SUBSCRIBE
(free)

• [TABLE OF CONTENTS](#)

MRH SPONSORS



Model Railroad Hobbyist | July 2018 | #101

A - D



acculites.com



railroadhobbyshow.com



archertransfers.com



athearn.com



www.atlasrr.com



bachmanntrains.com



backdropjunction.com

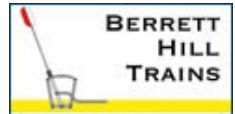

berrethill.com/trains



blairline.com



bowser-trains.com



mycaboose.com



coffmaneng.com



(youtube channel)



www.digitrax.com

[Vendors: Get your clickable logo here ...](#)

MRH SPONSORS | 2

E - R



trackplanning.com



esu.eu/en



handlaidtrack.com



handlaidtrack.com/mt-albert-scale-lumber



iascaled.com



lights4models.com



litchfieldstation.com



micro-trains.com



store.mrhmag.com



ncedcc.com



www.pwrs.ca/main.php



rapidotrains.com



ringengineering.com

When talking to hobby vendors, please remember to mention MRH.

[Vendors: Get your clickable logo here ...](#)

• [INDEX](#)



SUBSCRIBE
(free)

• [TABLE OF CONTENTS](#)

S - Z



scaletrains.com



soundtraxx.com



sodigi.com



sbs4dcc.com

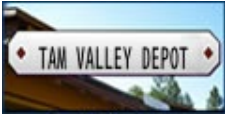

tamvalleydepot.com



tonystrains.com



traintekllc.com



walters.com



yankeedabblers.com

[Vendors: Get your clickable logo here ...](#)

Looking for something? Check the MRH Marketplace!

The screenshot shows the MRH Marketplace website with a grid of advertisements. Advertisements include: MAIN STREET AMERICA HISTORIC ARCHITECTURE, CROW RIVER PRODUCTS, USRA JIS Express Box NYP Redwood Empire, HOBBY MARKETPLACE ads are economical and effective, Click HERE to learn more., WESTERFIELD, yellow esp, STATE OF MAINE, Yarmouth Model Works, and others. At the bottom, there are links for MRH MAG.COM, SUBSCRIBE, INDEX, and TABLE OF CONTENTS.

Take me there!



LEGENDARY LOCOMOTIVES

RAILFAN FAVORITES RECREATED FOR YOUR LAYOUT

Starting 2011, an introduction of interesting paint schemes came from both the Norfolk Southern and Union Pacific. These special paint schemes honored veterans of the armed forces for both railroads. Norfolk Southern SD60E #6920 "Honoring Our Veterans" introduced 2011, and Union Pacific SD70ACe(SD70AH) #1943 "The Spirit" in 2017. Norfolk Southern also debuted "Honoring First Responders" SD60E #9-1-1 in 2014. These colorful and unique locomotives have been seen from coast to coast in a variety of service. Athearn™ brings these Legendary Locomotives to you, in HO scale as Genesis™.



2nd RUN!

SPIRIT OF UNION PACIFIC FEATURES:

- 2nd Run!
- PTC antenna array roof
- Headlights and ditchlights lit with LEDs
- Late handrails

Without Sound

ATHG19430 \$249.98

With Sound

ATHG01943 \$339.98



JUST ANNOUNCED!

NS 6920 FEATURES:

- 3900 gallon EMD fuel tank
- Cab mounted PTC antenna array
- NS designed snow plow
- Slotted style blower duct kick plate
- Prototypical cab panel louver arrangement

Without Sound

ATHG65204 \$249.98

With Sound

ATHG65254 \$339.98



DUE THIS SUMMER!

NS 9-1-1 FEATURES:

- 3900 gallon EMD fuel tank
- Cab mounted PTC antenna array
- NS designed snow plow
- Horse head style blower duct kick plate
- Prototypical cab panel louver arrangement

Without Sound

ATHG65200 \$219.98

With Sound

ATHG65250 \$309.98

ATHEARN.COM FOR MORE INFO



Find us on: YouTube®
Facebook® and Twitter®

HORIZON
H O B B Y

VISIT
Your Local Retailer

CLICK
Athearn.com

CALL
1.800.338.4639

SERIOUS FUN®

©2017 Horizon Hobby, LLC. Athearn, Genesis, Ready To Roll, Trainz in Miniature, Serious Fun and the Horizon Hobby logo are trademarks or registered trademarks of Horizon Hobby, LLC. The Union Pacific mark and other marks owned by Union Pacific are made under trademark license from Union Pacific Railroad Company. All other trademarks, service marks and logos are property of their respective owners. Final models may vary slightly from photos shown. 58851

• [INDEX](#)



SUBSCRIBE
(free)

• [TABLE OF CONTENTS](#)

TABLE OF CONTENTS



Model Railroad Hobbyist | July 2018 | #101

FEATURES



Rock Island U25-B #250

BOB RIVARD



Farmhouse for Goff Brock

CHRIS ADAMS

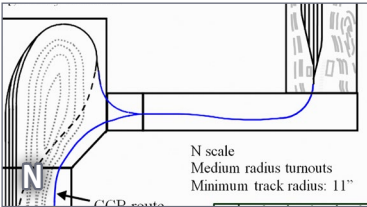

First place TOMA contest winner

PETER VASSALLO



Modeling Frisco 4026

DON WIRTH

TABLE OF CONTENTS | 2

COLUMNS

MRH Q-A-T

Compiled by **JOE BRUGGER**



DCC Impulses

Guest columnist **JOE FUGATE**



What's Neat

KEN PATTERSON



Imagineering

DAVE MEEK



Yes, it's a model

Compiled by **JOE FUGATE**



Derailments

Compiled by the **MRH Staff**



NEWS and EDITORIAL

Publisher's Musings

JOE FUGATE

News & Events

RICHARD BALE and **JEFF SHULTZ**

Reverse Running

JOE BRUGGER

ALSO:

MRH Marketplace

Subscriber extras

• [INDEX](#)



SUBSCRIBE
(free)

• [TABLE OF CONTENTS](#)

ALL-NEW HO FREIGHT CAR

7 ROADNAMES • PAINT SCHEME VARIATIONS

(Actual Models Shown)



4180cf GATC Airslide® Covered Hoppers

Preorder Now



© 2018 ScaleTrains.com, Inc. ScaleTrains.com, Rivet Counter, and respective logos are trademarks of ScaleTrains.com, Inc.
 ScaleTrains.com, Inc. 7598 Highway 411 Benton, TN 37307
 844-9TRAINS 844-987-2467 International 423-299-3689

Scene and photography
 by Ken J Johnson
 Preproduction model shown



• [INDEX](#)

• [TABLE OF CONTENTS](#)

PUBLISHER'S MUSINGS

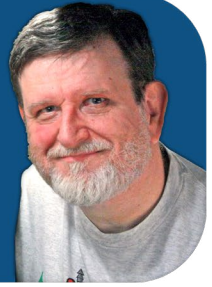

Model Railroad Hobbyist | July 2018 | #101

JOE FUGATE LOOKS FOR A NEW DCC COLUMNIST – AND REMINDS US OF THE POWER OF TRANSLATION



BRUCE PETRARCA IS RETIRING AS OUR DCC COLUMNIST once he writes his August column. So we're looking for a new DCC columnist.

If any of you reading this want to discuss filling this opening, please use the contact us form at mrhmag.com/contact/columnist-writer. Note: Don't quit your day job. This isn't that kind of position. Read on to learn more.

Rather, being a columnist gives you an automatic in with MRH for your article submissions and gets you a spot on the MRH masthead page. As a columnist you get 150% of our regular pay rate for any article (e.g., column) you submit.

For example, a 10-page column will fetch between \$300 and \$400. A regular article of that size pays \$200 - \$270 by comparison. So this position is mostly prestige and some nice monthly hobby mad money.

I've also been considering alternatives to the current approach with the DCC column.

One option would be to have multiple columnists like we do with our prototype modeling column, *Getting Real*. However, this could be both good and bad.



The good part with multiple columnists is spreading the burden of a monthly column across many modelers. But one disadvantage could be conflicting recommendations on how to do something with DCC – which would be quite confusing.

If we handle differing recommendations properly by clearly discussing the pros and cons of various approaches in each column, that could be enlightening. But it is something that cuts both ways.

The other option would be to broaden the column into a “recurring series” on all-things-electrical for your railroad. In other words, any article submission relating to the electrical / wiring space would be a candidate for this regular “series.”

Filling Bruce's shoes is a tall order, so unless someone of his caliber steps forward, my inclination is to move from a single-author

ADVERTISEMENT

Backdrop Junction
Your Stop for Railroad Backdrops

Click Here →

**For the Finest in Custom
Designed backdrop**



www.backdropjunction.com

ADVERTISEMENT



Archer
FINE TRANSFERS
PROUDLY SERVING MODEL BUILDERS SINCE 1989

THE ORIGINAL
SURFACE DETAILS™

**WE NOW HAVE MORE
THAN 130 SHEETS OF
RIVETS, LOUVERS,
TREADPLATE, WELD
SEAMS AND MORE
CAST ONTO
MICROSCALE CLEAR
DECAL FILM**

LOW SHIPPING:

**DOMESTIC USA ORDERS
\$2.80**

**INTERNATIONAL ORDERS
\$9.95**

→ **CLICK HERE TO
VISIT OUR WEBSITE!** ←

"Archer Fine Transfers 3D decals have revolutionized kitbashing and scratchbuilding. Putting rivets or other low-relief details like louvers or weld seams on your models is now as easy as applying decals."

Joe Fugate,
Publisher/Editor
Model Railroad
Hobbyist



Archer Fine Transfers • PO Box 1277 • Youngsville, NC 27596 • USA
(919) 570-1026 • info@archertransfers.com • archertransfers.com

WALTHERS

Layout Control System

HO, N, Z, S and O SCALE



NOW IN STOCK

Make the switch to Walthers for easy and affordable switch machine control!

Plug-and-play wiring eliminates splicing and soldering between the servo-based, slow-motion switch machine, power supply, LED pushbutton controllers and other accessories, each built tough for years of dependable operation.

User-friendly instructions and drilling templates are provided for easy installation on HO, N, Z, S or O Scale layouts using DC or DCC power.

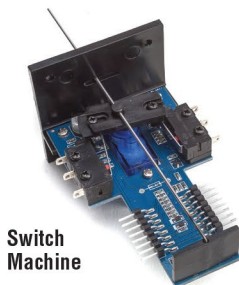

Switch Machine

Distribution Block



Dual Color LED Fascia Turnout Controller



Dual Color LED Fascia Crossover Controller

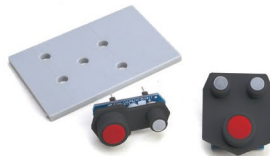

CLICK HERE TO LEARN MORE!

WALTHERS

Support your local hobby shop • visit walthers.com • call 1-800-4-TRAINS

Availability and prices shown were accurate at press time, for updates please visit walthers.com. Preproduction models shown, some details and colors may vary. ©2018 Wm. K. Walthers, Inc.

• [INDEX](#)



SUBSCRIBE
(free)

• [TABLE OF CONTENTS](#)

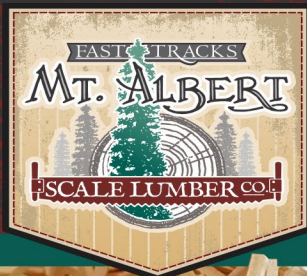

BULK CROSS TIES

5,000 AND 10,000 QUANTITIES

10% and 15% discount

MT. ALBERT PRODUCT LINE IS NOW AVAILABLE ONLINE!



Specializing in manufacturing fine scale lumber for model makers.

Easy ordering • Live online support • Earn Waypoints with every purchase

shop online 24/7

1-888-252-3895

handlaidtrack.com

service@fast-tracks.net

PUBLISHER'S MUSINGS | 3

DCC-focused column to a monthly all-things-electrical monthly series for any good DCC / electrical article we get.

I'm interested in what you, our readers, think of these options.

Please use the feedback link [mrhmag.com/magazine/mrh2018-07/publishers-musings] to let me know your thoughts.

The power of translation

What do you do when you see an article that isn't for your scale, prototype, or era? Do you just bypass it as irrelevant?

Or do you skim it anyway, seeing if it might have something useful you could adapt and use?

That's what I mean by the power of translation: learning to take any

CN *tempo*

in tune with the times



**HO SCALE
CLICK HERE**

• [INDEX](#)



SUBSCRIBE
(free)

• [TABLE OF CONTENTS](#)

CABOOSETM

Sharing Our Passion for Trains Since 1938



© 2018 John Harris Photography. All Rights Reserved.

CLICK HERE
for the
**Serious Modeler's
Resource!**

More than 148,721 items,
over 567 manufacturers,
**most at a discount from
full retail – all at
a fair price.**

**As always, in-stock orders of
\$100.00 or more ship free
within the Continental U.S.!***

*surcharges may apply for oversized items.

**10800 West Alameda Ave.
Lakewood, CO 80226
(303) 777-6766**

PUBLISHER'S MUSINGS | 4

model railroading article on any subject and milk it for useful ideas you can translate to your scale, prototype, and era.

Bypassing articles that you don't think fit what you're modeling is unwise. Learn the power of translation!

I model in HO, but I love reading about N scale, and we're blessed with two N scale magazines: *N Scale Railroading* [nscal-erailroadn.com] and *N Scale Magazine* [nscalemagazine.com]. Plus, I dearly love getting an N scale article submission to MRH – are you N scale modelers out there listening? How about sending an article our way?

I find many N scalers who are pushing the hobby envelope. Oh, the HO modelers have clever solutions too but don't discount the N scale modelers just because you don't model in their scale. I regularly discover great ideas for my HO modeling by keeping an eye on what the N scalers are doing.

The late Linn Westcott, editor of *Model Railroader* during the

N

SCALE



Item No. 51352 • UNION PACIFIC® #619

NEW

BALDWIN 2-8-0 WITH *ECONAMI*[™] IS A SOUND CHOICE!

Bachmann is delighted to offer our first N scale steam locomotive—the Consolidation—equipped with an *Econami*[™] *SoundTraxx*[®] steam package. Factory-set for 2-8-0 realism, the steam package offers a choice of 16 whistles, multiple variations of 6 bell types, 4 prototypical chuffs, 5 airpumps, and 4 dynamos plus cylinder cocks, grade crossing signal, blowdown, brake squeal/release, coupling/uncoupling, water stop, and "All aboard"/coach doors—all in 16-bit polyphonic sound. Visit your favorite hobby dealer to hear *all* the sound choices offered with the new N scale 2-8-0!

Features include:

- DCC sound-equipped with *Econami*[™] decoder
- precision motor
- operating headlight
- completely hidden drive train
- gear drive
- detailed cab interior



- separate sanding lines
- separate detail parts, including bell, whistle, pop valves, and handrails
- builder's plate
- die-cast, fine-scale driver spokes
- *E-Z Mate*[®] Mark II couplers, front and rear



NEW

WESTERN PACIFIC #35
Item No. 51351



NEW

NORFOLK & WESTERN #722
Item No. 51353

Click to
learn more



NEW

NYC® #1156
Item No. 51354



NEW

WESTERN MARYLAND® #751
Item No. 51355

SHIPPING SOON! MSRP \$399.00 each



Bachmann Industries, Inc. • 1400 East Erie Avenue • Philadelphia, PA 19124 USA • www.bachmanntrains.com

Click for more information.

• [INDEX](#)



SUBSCRIBE
(free)

• [TABLE OF CONTENTS](#)

1960s and '70s, had a policy: *do not* put the scale in the article title unless it really matters. I agree, and we follow that policy here at MRH.

The reason is simple: we want you to not miss out on great article content! We don't hide the scale from you – we try to mention it in the first paragraph of the article. But we also want to help you to stop having scale/prototype/era tunnel vision!

Learn to translate techniques between scales. Up-scaling techniques from the smaller scales to larger ones often works well. For example, if an N-scale article talks about how to resize the metal plates on a Kadee HO electromagnetic coupler to fit between the rails, the process likely will work to resize them for S or O scale as well.

Down-scaling from the large scales to the small ones may not work well if the scale jump is large. For example, down-scaling a technique from G scale to N scale may be iffy at best. But down-scaling a technique from HO to N scale often can work because the scale jump is much smaller.

Translating techniques between prototypes is much less of a problem. For instance, if an article on detailing a Great Northern diesel has some good insights on how to model see-through diesel grilles, that technique can apply to any number of prototypes.

Translating between prototypes can be trickier if you're a steam modeler. For example, learning how to model Wabash cab windows may not help you if you're modeling the Southern Pacific. On the other hand, the techniques themselves are often universal, so at least dig into the specifics enough to decide. Make an informed decision. Don't just tune it out!

Finally, we have translating between eras. Learning how to model 1920s yellow stop signs won't help much if you're modeling a 1980s red

Bowser

New
Announcements!!

HO 53' Roadtrailers

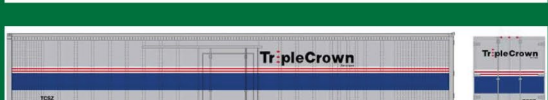
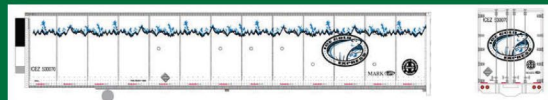
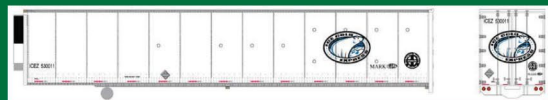

Ready To Run
Pad printed ends, sides & mud
flaps, silver roofs & more.
CouplerMate™ sold separately.
Only one CouplerMate™ per train

\$25.95 each

Road Names:
Alliance
BNSF
Schneider
Swift
Triple Crown

Coupler Mate
with deck details and steps installed
#40300 \$17.95 each In Stock



Click here to check out the details for these and other great
Bowser Products

• [INDEX](#)



SUBSCRIBE
(free)

• [TABLE OF CONTENTS](#)



**A good hobby
product for
under \$1?**

**You've got
to be
kidding.**



As low as

\$0.91 *(weekly)*

TrainMasters TV membership

A lifetime of hobby insight investment



Summer special pricing in effect!

Check it out!



www.trainmasters.tv

stop sign, for instance. But then again, if you simply replace the yellow sign with a more modern red one, the rest of the article may be very relevant. You still need a pole, and a sign, so take the time to translate!

Remember, if you tune out articles that don't match your chosen scale, prototype, or era, you're just hurting yourself. The great insights you may be missing could be significant. Learn to translate!

Contributions

I wanted to thank all of you who have donated to MRH over the last month. Your generosity has exceeded expectations!

That said, if you want to say thanks to MRH for 100+ issues of free model railroading how-to's [mrhmag.com/magazine/donate], please do so.

Even the smallest of donations is appreciated and helps keep MRH free for everyone even if ad revenue happens to fall short.

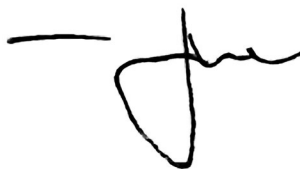

DONATE*

Donations help pay contributors for more excellent articles and videos, and help keep MRH free to all your fellow modelers.

* Donations for hobby publications are not tax-deductible.

**VIEW READER
COMMENTS**

click here





LAST ISSUE'S RATINGS

The five top-rated articles in the [June 2018 issue](#) of *Model Railroad Hobbyist* are:

- 4.8 Rebuilding the White Mountain branch
- 4.8 Freight car trucks of the 20th Century
- 4.8 MRH Q-A-T: modeling water, styrene as wood ...
- 4.8 Future of MRH's forever free business model
- 4.7 Getting Real: Modeling roundup - Marty McGuirk

Issue overall: **4.7**

Please rate the articles! Click the reader comments button on each article and select the star rating you think each article deserves. Thanks! ■

Get the latest Model Railroading News, Tips, Reviews & Opinions



Our iTunes feed has changed search for
"Mike And Scotty Live" to receive the latest episodes!

www.themodelrailroadpodcast.com

Hosts:

Scott Mason: www.scottymason.com

Mike Rose: www.mrhobby.com

Don't Miss our Monthly Interviews
& Product Announcements

Say

THANK YOU

to

Model Railroad
Hobbyist magazine™

click here

DONATE*

Donations help pay contributors for more excellent articles and videos, and help keep MRH free to all your fellow modelers.

** Donations for hobby publications are not tax-deductible*



Joe Fugate
Founder, MRH Media LLC

• [INDEX](#)



SUBSCRIBE
(free)

• [TABLE OF CONTENTS](#)

Make it run like a

Dream

ROLLING STOCK

102 pages

By Joe Fugate

NEW!
JULY SPECIAL

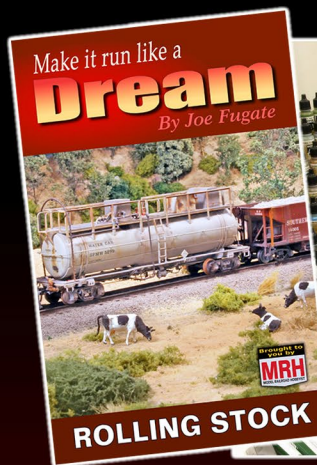

TOPICS INCLUDE: Setting standards • Building a test track • Wheelset/truck issues • Coupler issues • Carbody issues • Car weight considerations • Better maintenance procedures • Performance diagnosis & debugging • Special considerations

Click me to
Get eBook NOW >>
~~\$12.99~~ \$11.49

Format: Landscape and
Portrait PDF

Click me to
ORDER PAPERBACK >>
~~\$29.99~~ \$28.49

FREE shipping in US!
Foreign shipping 50%

Other books in this series: **TRACKWORK** (available now) and **LOCOS** (Fall 2019)

• [INDEX](#)

• [TABLE OF CONTENTS](#)

MRH ... QUESTIONS, ANSWERS, TIPS



Model Railroad Hobbyist | July 2018 | #101

compiled by **JOE BRUGGER**



Sealing wooden benchwork?

Q. I am about to buy lumber to build my small layout. I am using pine lumber and 1/2" fir plywood. I want to make it look good so am considering staining and applying polyurethane to the benchwork frame and legs. Would it also be worthwhile to prime and paint the plywood on top and bottom? I am thinking a light gray color. The layout is small enough that it wouldn't be a major outlay of cash or time but I am wondering if there would be any benefits.

—GregW66

A. Al Carter: A friend built his layout in his family room, and



THINGS TO THINK ABOUT:

Do you want to keep moisture out of the benchwork, or just make it look nice? Is your railroad in an area with major swings in temperature and/or humidity, or is it in a stable climate-controlled space?

▶ **MRH QUESTIONS, ANSWERS, AND TIPS**

• [INDEX](#)



SUBSCRIBE
(free)

• [TABLE OF CONTENTS](#)

painted the benchwork and underside white. I asked why – I had never heard of anyone painting benchwork before – and he said it looked better and was much easier to see things under the layout, what with reflected light, etc. Made sense to me.

When I built my benchwork, I discovered already primed pine at Home Depot. It is primed white and doesn't have issues with warping, contrary to unfinished wood. It looks better, and yes, it is lighter under there when I'm wiring, etc.

Moe Line: Greg, you maybe don't have the humidity that we deal with down south, but we always seal and paint wood benchwork to avoid the effects of extreme humidity that will warp, rot, and otherwise damage wood.



1. WaterSeal is sold at home, hardware, and lumber stores. There are several varieties and colors available.

I use multiple-ply Baltic Birch plywood because of its strength and resistance to warping. While it shouldn't delaminate, due to superior gluing methods and no voids within the plywood layers, I still paint and seal it, especially on the cut ends where the plies are exposed.

Peter F.: All my 'L' girders were painted with two coats of thinned shellac as a moisture barrier.

Mark Pruitt: If you're painting on a layer of interior latex paint, you're not sealing it to any significant degree. To get a fully effective seal using paint, start with an oil-based primer, then

add two coats of high-quality exterior latex house paint or a coating specifically designed to seal wood, like Thompson's WaterSeal or marine varnish. The easiest thing to do might be to humidity-control the room.

Greg W.: We do get fairly high humidity here in New Brunswick. We are fairly close to the ocean so that makes a difference. I don't think it will make much of an impact, as there is a dehumidifier in the room and the layout is small.

I don't think I will concern myself about sealing it completely. I do like the idea of a white background to wire on and I think a brown top would make sense as well.

Mike Lee: Here in Southern California all wood warps unless it is sealed with something. I say it is the dryness. When I built a special computer desk which later turned into a train workbench, I had experience with specialized homemade furniture and prior layouts warping and the cork roadbed crumbling.

I tried Thompson's WaterSeal left over from another project. I hit a home run! The wood does not move! Cork does not deteriorate, even after 19 years. Last time I bought it, it came in three tints plus clear, in metal gallon cans at Home Depot. If you are going to paint over the WaterSeal, wait four days for the water seal to finish gassing-off. Prep cork by wiping it down with WaterSeal and hanging it outside to dry. When it's ready, it can go back in its box.

Michael Watson: A couple of people mentioned painting the top in an earth tone, to prep it for later scenery work. I am not using plywood on top, but 2" foam. Painting it an earth color to get rid of the pink was the best thing I did. I just wish I had done it from the very beginning.

My railroad is in a sealed environment, with temperature and humidity tightly controlled, with neither varying more than 2%. I



did not stain or seal my select pine benchwork, and in 10 years it has not moved more than 5/64 inch. I did let the wood sit in the train room for four weeks before I cut anything to let it acclimate to the environment. I think it paid off in the long run. I do the same thing with any of the wood I use to build cabinets and furniture. Keeps all the joints tight, and fit and finish is excellent.

Read the whole discussion at mrhmag.com/node/33240.

Refrigerated containers

Q. I know that modern 53' perishable containers have their own self-contained reefer and fuel tank, but what about the 20' and 40' ocean-going containers? Are these no longer used,



2. Refrigerated containers on the Canadian Pacific at Lake Louise, Alberta, Canada, in January 2015. CP uses a big genset in a dedicated container placed in-between two blocks of cars. The genset looks like it powers eight containers on each side of the unit. *Andrew Hall photo*

LIGHTS4MODELS

LED's, Signs, and Sounds for
All Scales

FIRE CRACKER SALE

10% OFF ALL INVENTORY
7/1/18 THRU 7/7/18
USE CODE: USA18

Miller Signs | Evan Designs
Iron Penguin | Ring Engineering
EZ Line | Tomar | ITT Sound Boards
www.lights4models.com 614-296-8691

Lasercut structures. Highway,
storefront and billboard signs.

Neat ag customer for your railroad:
Farmers Fertilizer Supply



WHAT'S
NEW?



Established 1993...

Blair Line

ADVERTISEMENT

All Aboard the Hot Chocolate Special



COMING OCTOBER 2018

ACCEPTING PRE-ORDERS THROUGH JULY 16

ITEM #993 21 310 • \$229.95

**MICRO-
TRAINS®
LINE**

PRE-ORDER NOW

N
SCALE 1:160

• INDEX



SUBSCRIBE
(free)

• TABLE OF CONTENTS



3. Connections between cars and the generator-set container. While the containers are on the train they are powered by the genset. Once they are off, other power sources are used. *Andrew Hall photo*

or how do they get power while being transported via rail?
The A-line/Intermountain Thrall car has an option to build the generator/fuel tank on a platform end, but I have never seen one of these and am not really sure if they are still in service. How is it done now? I have heard something about a generator inside a container but I have never seen one of those either. When a non-self-contained reefer gets placed on a truck, how does it get power?

—Kirkifer

A. Russ Bellinis: I worked in the LA harbor in the 1970s and '80s as a refrigeration mechanic on containers. At that time the ships were built for 20' and 40' containers. Most containers in

NEW

"Mini Combo Right Clamp"™

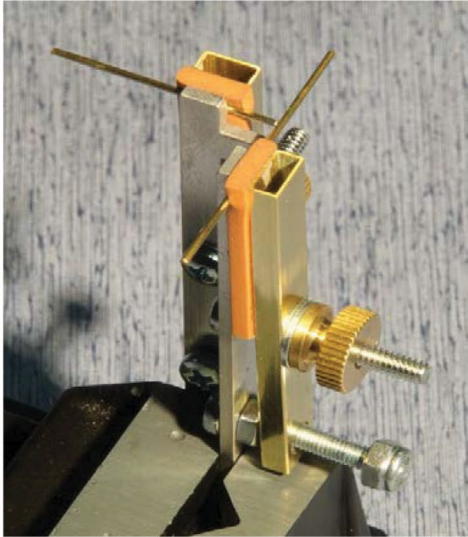

Versatility of our Combo Right Clamp in a very small package

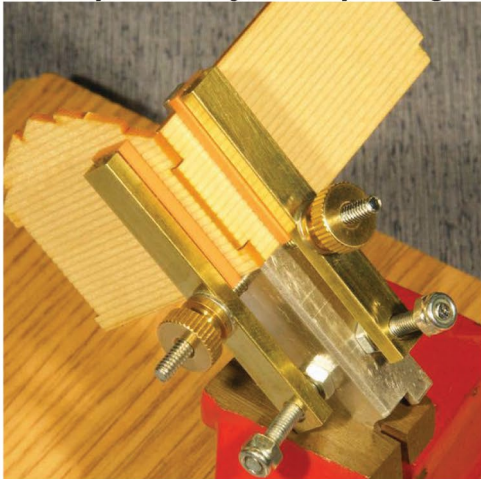

Coffman Graphic Solutions
1500 River Circle, Richmond, KY 40475

Click here

Visit our New Website:

www.coffmaneng.com

**Please include
a phone
number when
emailing MRH
(in case your spam
filters eat our
email response)**

Build stuff like this?



Subscribe

Daniel Cortopassi Productions

• [INDEX](#)



SUBSCRIBE
(free)

• [TABLE OF CONTENTS](#)

international service were electric, and plugged into shore power in the terminal, or ship's power on board the ship.

If the container was delivered locally, the unit was not operated to deliver because the product would not be without refrigeration long enough to cause a problem. If a container was to be delivered farther away from the terminal, or the load pickup was farther away, they would either have a chassis equipped with a generator set, or a clip-on generator would be clipped onto the top of the corner post in front of the refrigeration unit.

At that time 53' containers were used only in domestic service, never to go aboard ship. I don't know if new ships are designed for 53' containers or not. The design of a refrigeration unit is the same regardless of the size of a container.

I think I've seen some stack cars with large gensets mounted on the end of the car to plug reefers into. SeaLand had large gensets powered by air-cooled Deutz diesels that would power four units at a time. It would be mounted on the end of a car between two cars and the reefers on both cars were powered by the genset. SeaLand never had 20' containers.

Add to the thread at mrhmag.com/node/33060.



TIPS

Safe & handy tool storage

Like most model railroaders, I have a lot of small parts I use when building models.

To keep track of these, I recently purchased a small parts storage drawer from Walmart. When I got it home, I discovered it was



4. The recessed top of a multi-drawer unit is the perfect depth for tool-holding dense foam. *Michael Anteau*

too tall to fit where I had planned. The only place the drawer unit would fit was on the desk right in front of my working area, but that is where I keep my most frequently used tools, stuck in a piece of foam.

Looking closer at the drawer set, I noted that it had an open top. I carefully measured and then cut out a 1" piece of extruded foam insulation board to fit the opening. It fits very snugly, but can be easily replaced as necessary.

I stuck my tools into the foam, making holes to hold them snugly and within easy reach. With larger tools, I used a hobby knife to cut an appropriate hole first.

Now all my tools are in easy reach, mounted in foam. Parts are available in the drawers below. As an added bonus, the drawers are heavy enough to hold the foam securely when pulling tools from the foam.

—Michael Anteau



Donations help pay contributors for more excellent articles and videos, and help keep MRH free to all your fellow modelers.

* Donations for hobby publications are not tax-deductible.

GET PAID FOR YOUR TIP

We pay \$25 per tip we publish, or \$40 each if the tip also includes a photo or finished drawing.

[Click here and select article type TIP.](#) ■



Freight Car super-detailing

**NEW
VIDEO!**



**PREORDER
DVD media**

~~\$29.99~~
\$24.99

FREE shipping US
50% off shipping foreign

**Available now
VIDEO download**

~~\$14.99~~
\$9.99

HD format

from the
**Model Railroad
Hobbyist Store**

**Get
Video**



• [INDEX](#)



SUBSCRIBE
(free)

• [TABLE OF CONTENTS](#)

From first train set to railroad empire...

*Our complete line of DCC products
grows with you. Discover the fun!*

- Designed and manufactured in the U.S.A.
- Preferred for ease of use and ergonomic design
- Unlimited scalability for any size model railroad
- Plug-and-play means more time running trains
- Great customer service and excellent support



See your dealer



Visit our new and improved web site for all your DCC needs!

- Get the latest new product announcements
- Watch our detailed how-to videos
- Browse the all-new Information Station
- Enjoy secure online sales, day or night!

Visit **ncedcc.com**



• [INDEX](#)



SUBSCRIBE
(free)

• [TABLE OF CONTENTS](#)

Don't settle for all your locos
sounding the same!

ESU now has **OVER 100**
"LokSound" files to choose from!

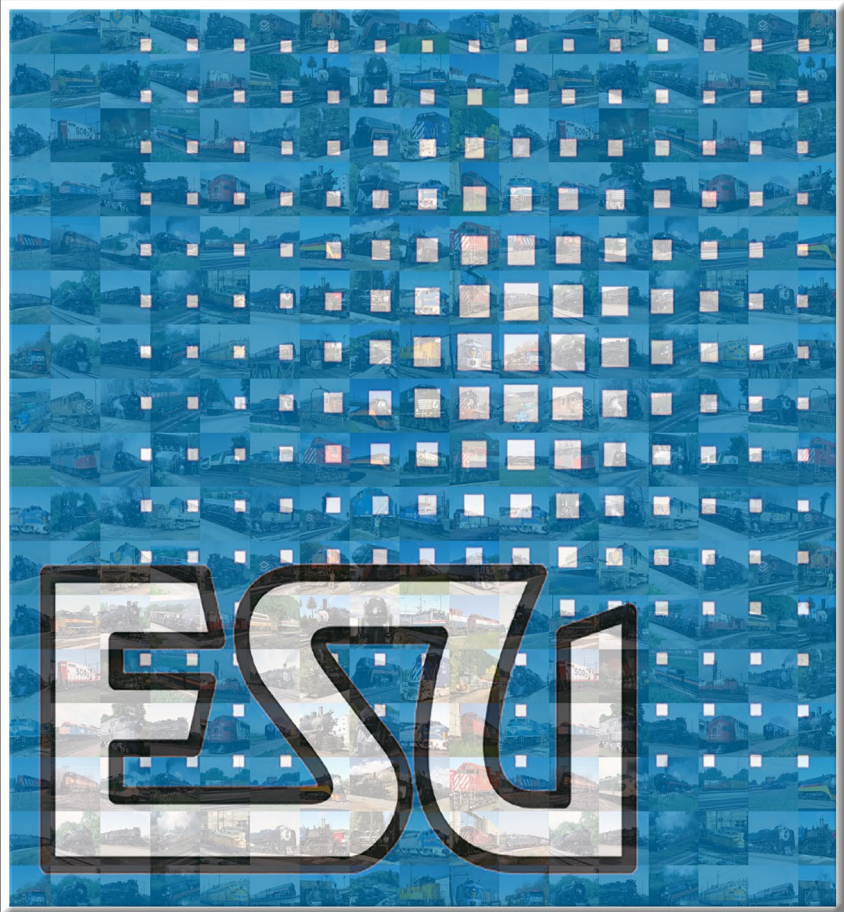

Because "Close Enough" is no longer
"Good Enough"

LokSound.com

DCC IMPULSES

column



Model Railroad Hobbyist | July 2018 | #101

GUEST COLUMNIST **JOE FUGATE**

LOOKS AT SOLUTIONS FOR ELECTRICAL
PICKUP WOES ...



RATE THIS ARTICLE

NOTE: Bruce Petrarca is retiring as our DCC columnist as of next month – that’s right, his last month writing this column will be August. We’re looking for a new DCC columnist to replace him. If you would like to discuss contributing regularly to MRH on the topic of DCC, [please contact us](#). Meanwhile, Joe Fugate is writing the DCC column this month while Bruce takes the month off.

I’M AN OPERATIONS GUY FIRST AND FORE-

most. I love ops – it drives everything else I do in the hobby. And nothing kills this part of the hobby more quickly for me than the seemingly inescapable stall.

Fortunately, we don’t have to put up with such electrical pickup woes – there are now very good answers to this problem, especially with DCC.

My focus here is how to make our locomotives more sure-footed. I’m talking about making our locomotives somewhat stall-proof, even on moderately dirty track. At the end of the day I want ultra-reliable

▶ **DCC TIPS, TRICKS, AND TECHNIQUES**

• [INDEX](#)



SUBSCRIBE
(free)

• [TABLE OF CONTENTS](#)

power pickup – so cleaning track (and wheels) is something needed only once in a while – not *every time* you turn the layout on.

The problem

The first step to solving any problem is to understand its root cause, so why is electrical pickup such a problem? Power pickup is essentially a mechanical process, relying on a tiny spot on the inside railhead [1] making good contact at all times for electrical current to flow to the loco.

Add dust, oil, and non-conducting metal oxide buildup from electrical micro-arcing at this tiny spot, and you can see how power pickup can get iffy. More wheels help by multiplying this tiny point of contact into a few more tiny points where electricity can flow.

Knowing that the wheel-rail contact point is so tiny, one solution should be obvious: make the point of contact larger.

1. Loco electrical pickup is a mechanical contact process: the tiny red dot marks the point of contact where electricity can flow. Contact occurs almost exclusively at this tiny spot on the inside railhead at the very bottom of the wheel. The red dot is exaggerated in size so you can see it – the true point of contact is an even smaller minuscule dot.

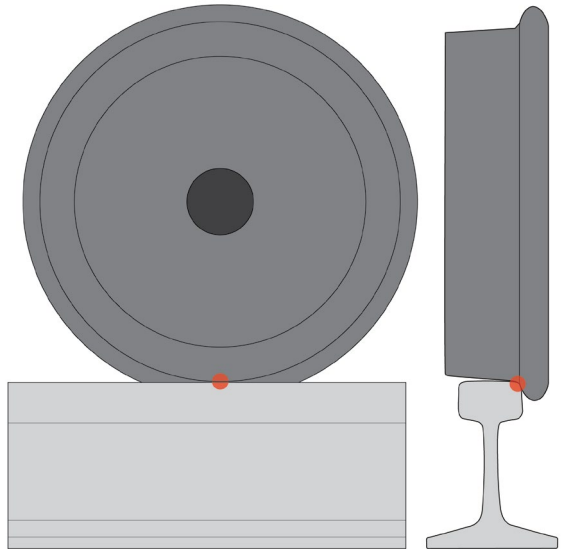

TONY'S TRAIN XCHANGE

Committed to your DCC support!

Broadway Limited HO USRA Mikado



July '18
Delivery!

**Impressive Features
with Paragon3 Sound & DCC**

ATSF, L&N, MILW, MP, NKP, SOU, W&LE,
WP, CN, ALTON, MEC, NYC, RI, PRR, SAL, UP

Just \$269.95

Order Yours

Athearn Genesis HO EMD GP9



Available
Late June '18

**Impeccably Detailed in
DC or Tsunami2 Sound**

MRL, BN, ATSF Zebra, SP&S, PRR,
N&W Blue, N&W Tuscan, & MEC

Starting at \$161.48

Order Yours

PSX Circuit Breakers



PSX1, PSX2, PSX3, PSX4:

Protect up to 4 DCC
Power Districts!

PSX-AR: Integrated
DCC Circuit Breaker
and Auto-Reverser!

Just \$37.95

Order Yours

**Do you need a Sound or
DCC Installation done?**

Get a quote!



Providing unmatched person to person
DCC support for more than 25 years, the
kind of service that has made us #1 in DCC.

DCC questions? CALL US! 1-800-978-3472

We'll get you on the right track!

July 2018



• [INDEX](#)



SUBSCRIBE
(free)

• [TABLE OF CONTENTS](#)

Adding wipers

Adding track wipers can make a dramatic improvement in power pickup. Because the normal point of contact is so tiny, it doesn't take much additional contact area to make a huge improvement in power pickup reliability.

For example, look at this Athearn SD9 blue-box locomotive with Tomar Industries railhead wipers installed [2, 3]. Adding these wipers made this loco extremely sure-footed, even though it's an older Athearn loco still using sintered metal wheels (read: they get dirty quickly).

This SD9 still runs great even if the track and wheels get dirty. Using sliders like this means I don't have to clean track and loco wheels nearly as often.

If you include the extra surface area these railhead wipers add to the tiny wheel contact points, you can see they add the equivalent of hundreds of extra wheel contact points – making for a huge improvement in total electrical contact surface.

To install a Tomar slider on the power truck, I bent it around so I could solder it to the metal plate of the truck with

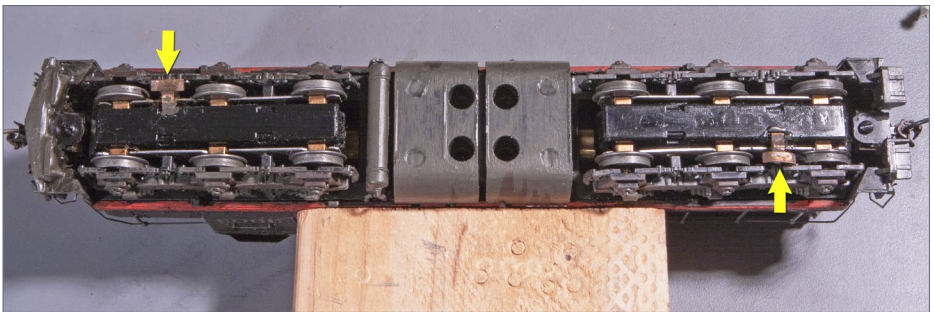

2. Adding Tomar phosphor-bronze railhead sliders (yellow arrows) to this blue-box Athearn loco makes it extremely sure-footed when it comes to electrical pickup. Note the old-style sintered metal wheels are not particularly clean, yet the loco still runs without stalling!

Great control in a tiny package



**Original
Touch Toggles**

- Touch Toggle™ plug in controls
- Bright clear indication
- Easy setup
- Flexible system

Stall Motors, Twin-coils,
Power, and Servos

Now for Tam Valley Depot
and MRservo too!

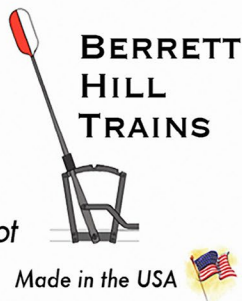

What will they think of next?

www.berrethillshop.com

ProtoThrottle

Realistic Control Stand Throttle

Announcing our
two exclusive dealers:

**SPRING CREEK
MODEL TRAINS**

DESHLER ★ NEBRASKA

CABOOSE

Sharing Our Passion for Trains Since 1938

Operate the ProtoThrottle
during the **St. Louis RPM** in July
and **receive a free gift.**

LEARN MORE: www.iascaled.com

TamValleyDepot.com



Celebrating 10 Years
of Serving the Hobby
2008 - 2018

Dual Frog Juicer

Automatic DCC Polarity
Reverser

Power Two Frogs

Crossovers

Crossings

Automatic Reverser for

Turntables

Wyes, Loops

Circuit Breaker



**MRH
Supporter
since 2009**

Use with 2-10 Amp Systems



Make LocoNet wiring extremely simple!

ACCU-LITES, inc

Your DCC Center!

Dealer Inquiries Accepted

PM42
breakout board



SE8C
breakout board



BDL168
Multi-zone
breakout board



BDL168
Single-zone
breakout board



Now Offering SNAPS! in packs of 6 or 12 pieces! [CLICK TO LEARN MORE ...](#)

INSTANT ANSWERS

SHOP FOR ANSWERS



Put your hobby into overdrive

Downloadable books and videos from ... **The Model Railroad Hobbyist Store**

www.SBS4DCC.com

Introducing the NEW **ZIMO MX660**
Micro Sound Decoder



DELIVERABLY NARROW

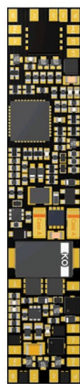

AMAZINGLY THIN

48 x 9.5 x 2.2mm

0.7 amp Continuous Current

6 Function Outputs w/ 1k ohm Resistors

1.1 watt, 8 ohm Amp

Universal format with Large solder pads for easy connection

Flat for easy mounting

Full ZIMO Feature set

Available 2018

N – HO – HO_{N3} Scale Trains



STEAM LOCOS TOO!

While the examples in this article show diesels, these techniques work great with steam locos as well.

3. Once you paint Tomar railhead sliders black on top, they pretty much disappear. The yellow arrows point to the slider in these photos of the SD9 from [2] on the layout. You have to really look to see them!

low-melting-point solder paste [4]. It does take a little fiddling to get the downward pressure just right. You want the sliders to not press *too* hard against the railhead so they will not catch or snag at turnouts and grade crossings.

Also, we need to keep in mind the entire electrical path from the railhead to the decoder. From the railhead, the electricity generally travels through metal wheels to their metal axles, then to their respective metal plate on each side of the trucks.



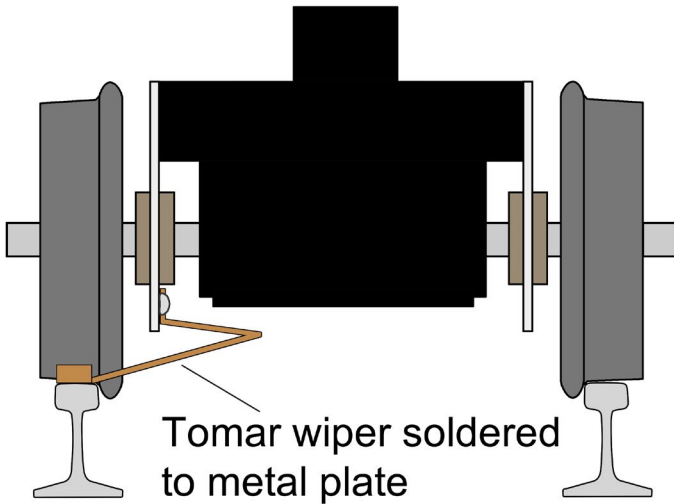

4. I added the Tomar wiper to the blue-box Athearn loco by folding it and soldering it to a truck's metal plate as shown. By adjusting the V-bend angle, I can control how much tension the wiper puts on the rail.

From there, each truck metal plate has a wire going directly to proper motor terminal.

Wheel-face wipers

The weak point in this path after the railhead is typically the axle-to-metal plate contact. To get around this weakness, it can help to add wipers to the wheel face [5].

Modern model diesel locos generally put the metal plate outside the wheels behind the side frames, rather than behind the wheels next to the gear housing [6]. In this case, we're relying on the axle tips to make good contact with edges of the hole in the metal plate and for the holes to not wear.

In my experience, the reliability of the axle-tip-to-side frame-metal-plate varies. In some cases, it's quite poor. In other cases

Litchfield



S T A T I O N

"Where we make DCC fun!"

**We Carry
A Full Line of
Digitrax Products
at GREAT Prices!**



**Lenz is back
& we have stock
available!**



Click here to visit our website:

**www.LitchfieldStation.com
623-298-7355**



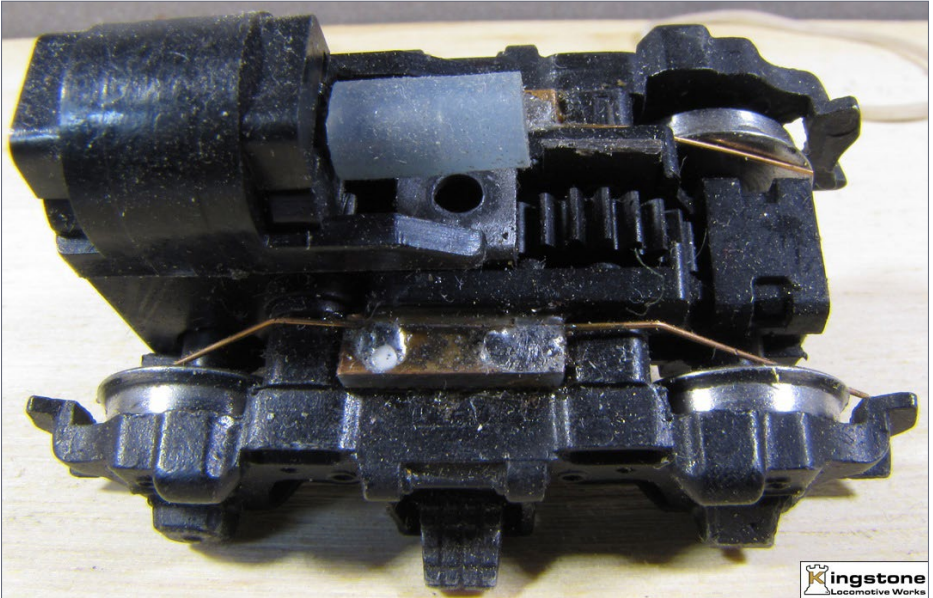

5. Adding wheel wipers to a loco such as those shown here adds an alternate electrical path directly from the wheels and bypasses the sometimes weak wheel-to-axle-to-metal-plate path. Adding a wire from the wiper PC board to the loco motor PC board or decoder also improves reliability by providing a second path for the electrical current. *Photo by Bernd Fanghanel*



PHOSPHOR BRONZE

Phosphor bronze is known for its toughness and strength along with high corrosion resistance, exhibiting exceptional plating and spring properties.

it's pretty reliable. I think the variation comes from two main factors: 1) does the manufacturing process maintain a tight tolerance on the size of the hole, and 2) what kind of metal is used to make the side frame plate?

Some manufacturers use phosphor bronze and machine-drill the hole. Other

manufacturers use soft copper and stamp the hole into the side frame. Phosphor bronze is a harder metal than plain copper, so the phosphor bronze side frame plates don't wear as easily as copper plates do. Also, machine drilling is a more precise process than stamping.

So the most reliable loco side frames use phosphor bronze and machine-drilled holes. The least reliable use soft copper and stamped holes.

A helpful trick to quickly minimize this issue is to cut off a few loops from an O scale coupler centering spring and to put it on the axle tips [7]. This gives an extra path from wheel face and axle to the side frame metal plate.

These are mechanical solutions to improving locomotive power pickup and they can make a big improvement. But thanks to recent developments in super-capacitors, most DCC decoder

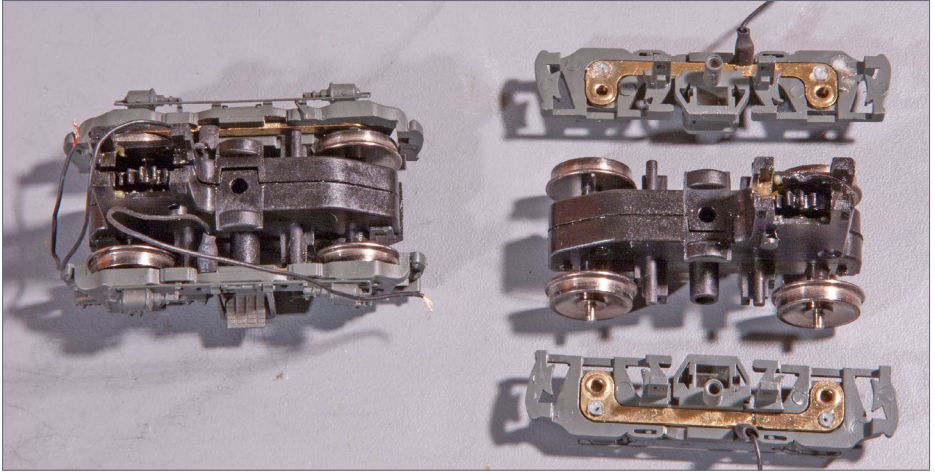

6. Many modern HO diesel trucks have metal plates in the side frames like you see here. The electrical contact point becomes the wheel axle tip through a hole in the metal plate. The reliability of the electrical path depends on how much slop exists between the axle tip and the hole.

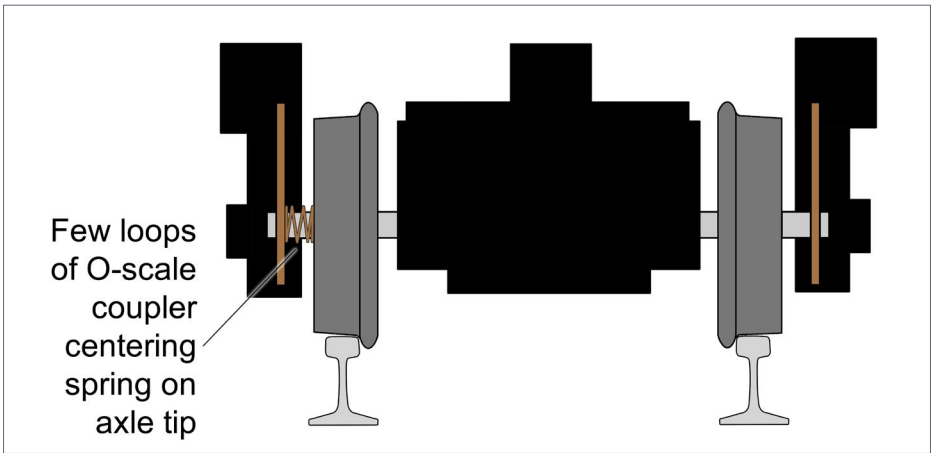

7. To improve power pickup on locos that rely on axle-tip-to-side frame contact, put a few loops of an O-scale coupler centering spring on each axle tip. Don't overdo it, though, or you'll start to create extra drag and limit your loco's pulling power. Just a few loops with minimal pressure guarantee a current path between the wheels and the side frames.



WIPERS OR KEEP- ALIVE?

I prefer the “belt and suspenders” principle when it comes to reliable operation: I go with both wipers *and* keep-alive.

I start with wipers and add keep-alive as the budget allows.

makers also now offer an electronic solution to poor power pickup: keep-alive.

DCC keep-alive

DCC keep-alive does pretty much what you think – it uses capacitors to store up and supply power to the loco even if the loco is experiencing intermittent railhead-to-wheel contact.



Southern Digital

WWW.SODIGI.COM

Celebrating 25 Years of serving you !

Go Wireless InfraRed Expanded Zephyr System



Everything you will need to run 2 DCC trains.



~~\$390.00~~ Value
\$310.00 Your Price
\$80.90 You Save



DCC Conversions, Service & Support
E-mail: sales@sodigi.com (770) 929-1888



• [INDEX](#)



SUBSCRIBE
(free)

• [TABLE OF CONTENTS](#)

When the loco is getting power from the rails, that power maintains a charge in the keep-alive capacitors.

Then when the loco experiences any power interruptions from the track, it keeps right on rolling as if nothing happened.

Really poor and infrequent electrical contact, however, means the loco won't be very responsive to throttle commands either. While keep-alive helps tremendously with intermittent loco-to-rail contact issues, you will need to clean the track and wheels periodically if you want the loco to stay responsive to the throttle.

Let's look at what's currently available on the market from DCC decoder manufacturers when it comes to keep-alive boards [8].

ADVERTISEMENT

No Cams. No Fuss!

SOUNDTRAXX
WATCH ON  YouTube 

Tsunami² Steam Digital Sound Decoders do not require the use of a cam for synchronized exhaust! The Exhaust Chuff rate is automatically calculated in response to the demand on the

motor, no wheel disassembly, no soldering wires or cams. The faster the motor spins, the faster the wheels spin and the faster the chuff rate, matched perfectly to the movement of the model!

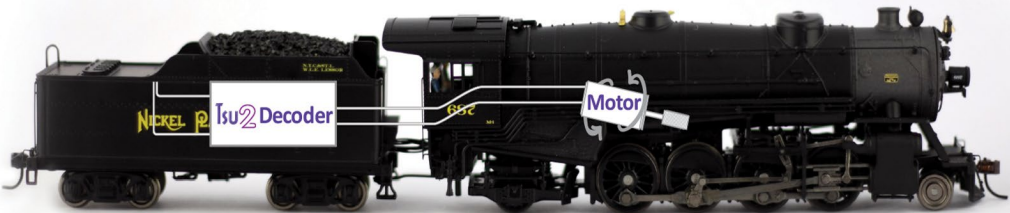

SOUNDTRAXX™

www.soundtraxx.com

ADVERTISEMENT

YD



Yankee Dabblers

www.yankeedabblers.com (856) 312-8084

101 West Kings Hwy, Bellmawr, NJ 08031

In Philly? YD store is 1 mile from NJ end of Walt Whitman Bridge

Visit OUR NEW WEBSITE! SAME GREAT SERVICES & PRICES!

SEARCH
BUTTON

Search

Call us at PH: (727) 457-9227

My Account

Gift Certificates

Sign in or Create an account



HOME SCALES BRANDS SHIP/RETURNS CONTACT SHOW SCHEDULE NJ STORE HOURS



Brands

YD Products

View all Brands

Categories

DCC PRODUCTS

View All Categories

"CLICK" ON SPECIALS

Featuring ESU CabControl DCC Wireless System & Wifi Mobile Control Cab

FEATURED PRODUCTS

Sale \$385



Plus New ESU
"N" Scaled
Sound Decoders



Add 2nd CAB
to order
Sale \$240

Specializing in DCC! ~ The Best for Less! ~ Sales-Services-Installation!

Free Technical Coordination (727) 457-9227 9AM to 9PM EST

Stop by and meet us at the following hobby shows:

CLICK AND SAVE TODAY!

Click on
Show Schedule
for info links

NMRA
Kansas City, MO
Aug. 10 -12, 2018

Use coupon code "MRH" for FREE SHIPPING
YD installs DCC or RailPro in your engines

ADVERTISEMENT

RailPro™

NEW
TECHNOLOGY

RE RING™
ENGINEERING

DCC + RADIO CONTROL
HO Scale Locomotive Module

ULTIMATE
SERIES
SOUNDS

TRUE
MOTION
TECHNOLOGY

LIGHT
EFFECT
EDITOR



New Sound Technology and Mathematical Model Motion Control + more!!!



+



Equals
"DUAL MODE"
Control by DCC +
Radio Control

Click Here to
Watch Video

For more information visit our Internet site: www.RingEngineering.com





• INDEX



SUBSCRIBE
(free)

• TABLE OF CONTENTS

8. Table of currently available keep-alive boards. Special thanks to Mark Gurrries for some of this table data.





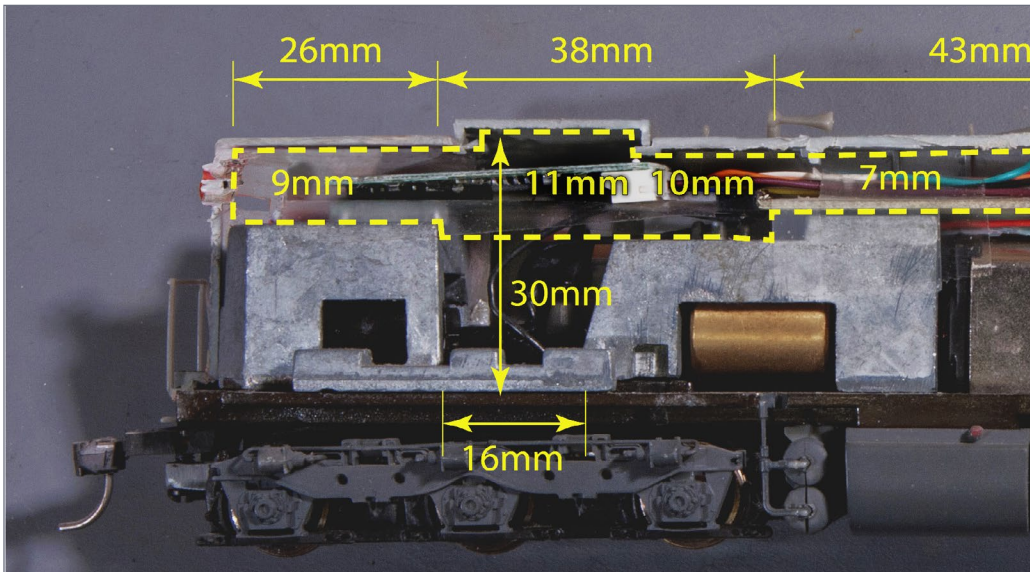

Product image				
Vendor	TCS	TCS	SoundTraxx	ESU
Model Nbr.	KA3	KA4	Current Keeper	Power Pack Mini
Approx run time	6-20 sec	6-20 sec	1-10 sec	1-3 sec
Wire count	2	2	2	3
Size (mm)*	26x12x9	14x14x12	40x11x6	16x10x13
List price	\$27	\$27	\$30	\$50
Notes	Two types available: type C includes a 2-pin connector that plugs into TCS decoders	Two types available: type C includes a 2-pin connector that plugs into TCS decoders	Electronic solution only, has no CV settings.	Three wires allows ESU decoders to shut off keep-alive automatically on program track

* Size dimensions are length x width x height. A typical HO diesel has a about 18mm of width inside a narrow hood shell.



9. To give you an idea of the space typically available inside an HO diesel loco, here is a cross-section of a Proto-2000 SD9. This loco is actually fairly roomy above the motor and weights. Some locos

DCC IMPULSES | 11

					
ESU	Digitrax	Digitrax	NCE	NCE	Lenz
Power Pack Maxi	PX108	PX112	No-Halt Small	No-Halt Medium	Power 1
1-3 sec	1-5 sec	2-10 sec	2-6 sec	2-10 sec	1-2 sec
3	2	2	2	2	3
28x16x13	26x13x8	40x14x8	32x16x8	54x16x10	22x14x10
\$70	\$26	\$26	\$28	\$30	\$65
Three wires allows ESU decoders to shut off keep-alive automatically on program track	Multiple versions available in different wire harness form factors	Multiple versions available in different wire harness form factors	Recommended for HO or smaller scales.	Recommended for HO or larger scales.	Designed to work with Lenz decoders primarily.

about 6-10mm of space between the top of the motor and the bottom of the shell, and

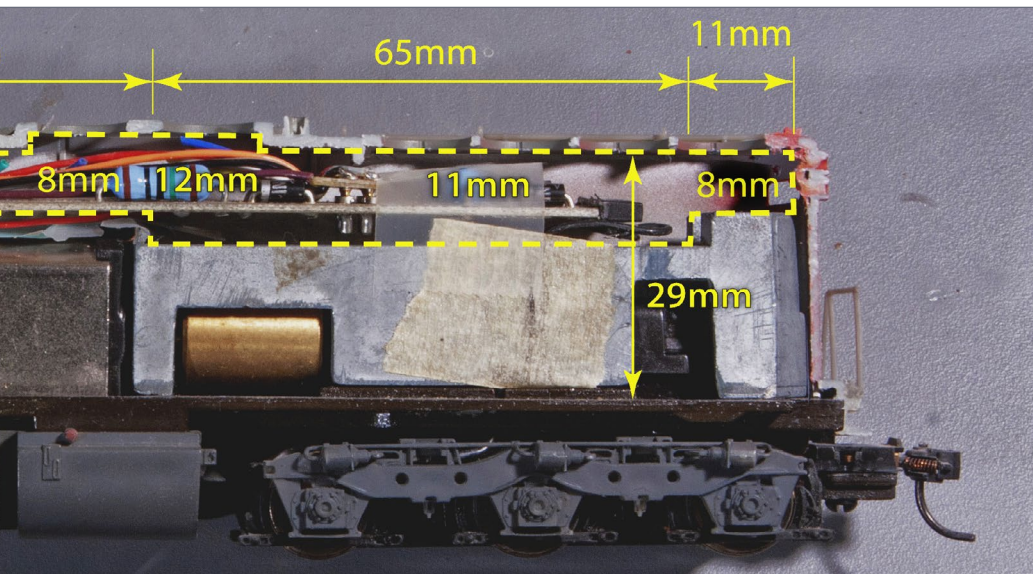

average closer to 6mm above the motor and weights. Older Bachmann diesels have even less space, with the weight taking all but a few millimeters of the space inside the top of the shell.



When it comes to getting things to fit, the typical narrow diesel hood shell has an inside width of 18-19mm (0.7-0.75"). As for space between the top of motor and inside top of the shell, that is typically 6-12mm (0.24-0.39"). Measure your specific loco to be sure.

Steam locos are generally easier to work with, since most have a tender with a good amount of space for DCC electronics such as keep-alive.

The smallest keep-alive boards are those from TCS and from Digitrax. The two Digitrax boards are particularly small, with both of them being only 8mm (0.32") thick. Unfortunately, the ESU boards are 13mm (0.51") thick, which is too fat for many HO diesels without milling the weight.

Older Bachmann diesels are a particular challenge, since the integral chassis weight fills all but a few millimeters of the space inside the shell. To make room for a decoder, speaker, and keep-alive, you need to mill the chassis weight [10].

The TCS keep-alive boards give the longest keep-alive action, from 6-20 seconds. While this is impressive, a possible downside is that's how long your loco will keep running if it loses connection or runs off the end of the track. The Digitrax PX108 (1-5 seconds) may be a better choice if you prefer something shorter to be safe.

Most new decoders (made after 2012) now come with solder pads on them for the keep-alive wires, making adding keep-alive a fairly easy task. (Adding keep-alive to older decoders is beyond the scope of this column.)

Finding space for the keep-alive board is the harder task, but thanks to a new innovation by TCS, finding this space may have just become easier.

TCS keep-alive mother boards

Train Control Systems has gone one step further with keep-alive by making the boards available as space-saving replacement

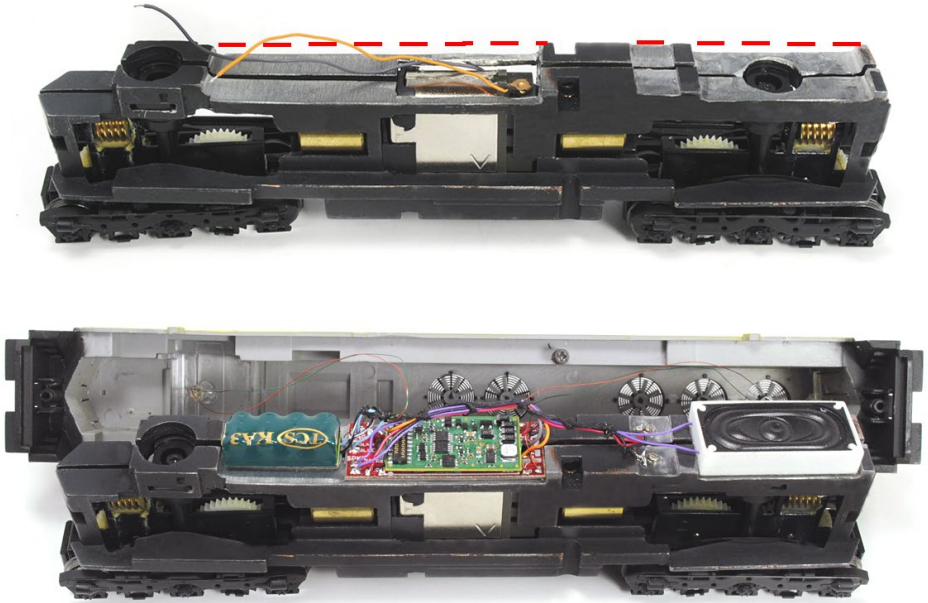





10. Some older Bachmann diesels have an integral chassis weight that fills most of the shell. To get room for a decoder, keep-alive, and a speaker, you need to mill the frame as shown in the top image. Also in order to get some place to connect the track power feeds, mill a small spot just ahead of the speaker area, then drill and tap for some screws. The motor also needs to be insulated from the frame. The bottom photo shows that everything does fit thanks to the milling. *Photo by Train Control Systems*

motherboards. These mother boards are particularly handy because they often put the keep-alive capacitors in clever unused spaces such as over the flywheels [13].

Here is a table of the TCS keep-alive replacement motherboards for diesel locomotives [11] and for steam locomotives [12].



These motherboards use a 21-pin socket, which is an evolving new standard for sound decoders. The extra pins make it easier to add speaker wires and extra lighting function wires in more of a plug-n-play fashion. In the case of the TCS motherboards, any soldering

11. Here are the TCS replacement keep-alive motherboards for diesel locomotives.

Product image				
Vendor	TCS	TCS	TCS	TCS
Model Nbr.	AK-MB1	AS-MB2	AS-MB2-NC	GEN-MB1
Approx run time	6-15 sec (KA2)	6-20 sec (KA4)	6-20 sec (KA4)	6-15 sec (KA2)
Replaces	Atlas/Kato	Atlas/Kato	Atlas/Kato	Athearn Genesis
Size (mm)*	54x17x8	46x17x5	46x18x6	72x17x14
List price	\$50	\$50	\$50	\$50
Notes	All functions (F0-F6) have built-in resistors for LEDs.	For locos that use contectorized leads. All lighting functions (F1-F6) have built-in resistors for LEDs.	All functions (F0-F6) have built-in resistors for LEDs.	F0 is for 1.5v bulbs only. F1-F4 have solder pads for both 1.5v bulbs and LEDs. F5-F6 are LED only.





* Size dimensions are length x width x height.





12. Here are the TCS replacement keep-alive motherboards for steam locomotives.

Product image			
Vendor	TCS	TCS	TCS
Model Nbr.	B-MB1	B-MB2	B-MB3
Approx run time	6-15 sec (KA2)	6-20 sec (KA4)	6-20 sec (KA4)
Replaces	Bachmann light 4-8-2 / 2-8-0	Bachmann heavy 4-8-2	Bachmann Baldwin 2-8-2
Size (mm)*	51x31x13	36x30x13	51x31x13
List price	\$37	\$37	\$37
Notes	All functions (F0-F6) have built-in resistors for LEDs.	All functions (F0-F4) have built-in resistors for LEDs.	All functions (F0-F6) have built-in resistors for LEDs.

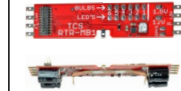
* Size dimensions are length x width x height.

DCC IMPULSES | 15

				
TCS	TCS	TCS	TCS	TCS
IB-MB1	IB-MB1-NC	IB-MB2	IB-MB2-NC	RTR-MB1
6-15 sec (KA2)	6-15 sec (KA2)	6-15 sec (KA2)	6-15 sec (KA2)	6-15 sec (KA2)
Intermountain / Bowser	Intermountain / Bowser	Intermountain / Bowser	Intermountain / Bowser	Athearn Ready-To-Roll
72x18x8	72x18x8	72x18x8	72x18x8	72x17x14
\$50	\$50	\$50	\$50	\$50
Connectors on board match those on the original loco motherboard. Just plug and go.	Solder pads on board match the wires on the original loco motherboard.	Connectors on board match those on the original loco motherboard. Just plug and go.	Solder pads on board match the wires on the original loco motherboard.	Has motor clip like original motherboard. F0 is for 1.5v bulbs only. F1-F4 have solder pads for both 1.5v bulbs and LEDs.

			
TCS	TCS	TCS	TCS
B-MB4	B-MB7	B-MB8	P2K-MB1
6-15 sec (KA2)	6-20 sec (KA3)	6-20 sec (KA3)	6-15 sec (KA2)
Bachmann Raymond 4-4-0	Bachmann steam including K4	Bachmann steam including 4-6-0	Walthers Proto 2000 0-6-0 / 0-8-0
49x27x13	64x30x12	55x27x8	74x31x9
\$37	\$37	\$37	\$37
All functions (F0-F6) have built-in resistors for LEDs.	All functions (F0-F6) have built-in resistors for LEDs.	Built-in resistor for F0F LEDs. No other LED functions on board.	All functions (F0-F6) have built-in resistors for LEDs.



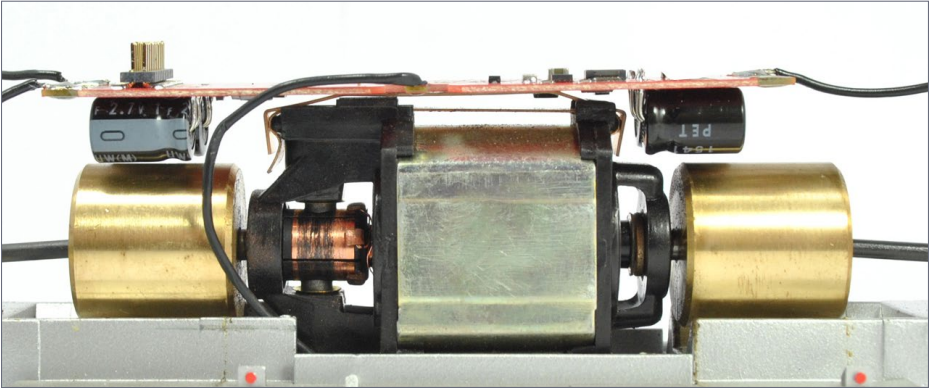

13. Example of how a TCS keep-alive motherboard replacement locates the capacitors in otherwise dead space over the flywheels. This clever trick allows fitting keep-alive into locos more easily. *Photo by Train Control Systems*

you need to do, you do to the motherboard. The decoder just plugs right in.

Besides accepting TCS sound decoders (obviously), the TCS motherboards also accept an ESU LokSound decoder after a fashion [14]. The decoder sits at an odd angle, but it does work fine. Unfortunately, SoundTraxx Tsunami2 decoders with 21 pins do not fit – the components and pin socket on the board are too fat. So life is not perfect.

Also, one big caveat with keep-alive in a loco – they can interfere with the programming track function. When first placed on the track, the keep-alive will generally draw power from the programming track, confusing the command station.

Next, reading back CVs involves the decoder pulsing the command station to signify the decoder value. Keep-alive interferes with that pulsing action by drawing current from the track to keep the capacitors charged.

ESU keep-alive boards, when connected with ESU decoders using the three wires provided, become programming-track aware. They

automatically turn off keep-alive when they detect the loco is on a programming track – very handy!

The TCS motherboards have another nice feature – they include onboard resistors for 1.5V bulb and/or LED lighting. That said, some boards only have F0 resistors for 1.5V bulbs and not for LEDs. In that case, TCS says to use the F1 or F2 LED solder pads and remap the decoder function back to F0 – so just a bit more hassle, but less work than adding resistors for the LEDs.

Other TCS motherboards just have pads for LED lighting and not 1.5v bulbs – it all depends on what typically comes with the locomotive from the manufacturer. I suspect it won't be long until 1.5v bulbs no longer are used since LEDs work fine and they have a lot longer life.

So in summary, the TCS motherboards have these advantages:

1. They save space by replacing the loco's stock motherboard instead of adding to it.
2. They provide on-board resistors for both 1.5V bulb and/or LED lighting.
3. They provide a common place to solder all the loco wires, allowing the decoder itself to remain plug-and-play.

Summary

Between mechanical pickup wipers and keep-alive, we no longer need to deal with loco stalling woes again.

Put together, wipers plus keep-alive provide a belt-and-suspenders method of guaranteeing our locos become extremely sure-footed and stall-proof.

**VIEW READER
COMMENTS**

click here





Complete Train Control

Introducing Wifi Interf

- **Wi-Fi interface to a Digitrax LocoNet for up to four compatible mobile Wi-Fi devices and Apps.**
- **Compatible with most Android and Apple devices running supported throttle apps**
- **Easy Setup and Configuration. A single LNWI works 'out of the box', with no additional configuration required.**



LNWI Loconet
The LNWI allows
to LocoNet and r

Find out how eas

g the LNWI face



et Wifi Interface | **\$79 MSRP**
you to connect compatible WiFi devices
run trains using compatible throttle apps

by it is @ www.digitrax.com/throttleapps/

• [INDEX](#)



SUBSCRIBE
(free)

• [TABLE OF CONTENTS](#)

Ultimate switching tutorial

Up close and personal ...

with Mike Confalone

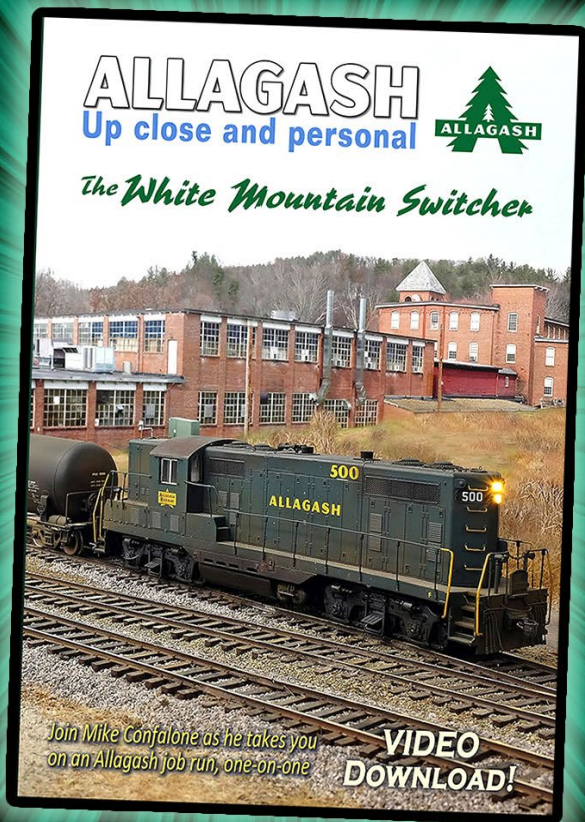

Pre-order
and **SAVE!**

DVD media

~~\$29.99~~

\$24.99

FREE shipping US

50% off shipping foreign

Video download

~~\$14.99~~

\$9.99

HD
format

Running time: 2 hours (Releases end of July)

 Pre-order White Mtn Switcher

from the
**Model Railroad
Hobbyist** *Store*

WHAT'S NEAT

column



Model Railroad Hobbyist | July 2018 | #101



RATE THIS ARTICLE

KEN PATTERSON LOOKS AT G SCALE, AND TALKS TO RON PARE ABOUT MODELING FROM PHOTOS ...

THIS MONTH WE LOOK AT BILL WHITE'S INDOOR G scale layout. Ron Pare shares his Chinese architecture in HO scale with a building he copied from photos. Steve Mann shows his double-deck C&NW HO scale layout. For layout construction, we build a new lift-out section for a walkway on my layout, and we look at some 1/29th scale auto racks from USA Trains.

**VIEW READER
COMMENTS**

click here

▶ PHOTOS AND VIDEO OF SUPERB MODELING

• [INDEX](#)



SUBSCRIBE
(free)

• [TABLE OF CONTENTS](#)

Improving a lift-out section



1. (Above) I wanted to replace this foam lift-out section on my layout with a simpler design that would be 5 inches wide rather than 13 inches, and have a 3-inch higher clearance, making it easier to duck under. I figured it could be made from simple plywood. I started by removing the old lift-out section. It was held in place by door hinges and pins, so I pulled out the hinge pins and removed the section by lifting it up and unplugging the 2-conductor microphone jack.

2. (Top right) I placed the old lift-out section on my work table and covered it with brown packing paper pinned firmly in place. I used a crayon and rubbed it on its side to mark the tops of the rails exactly as they run through the scene. This created a template of the track flow.

3. (Bottom right) After cutting the paper template, I taped it to a $\frac{3}{4}$ -inch thick piece of plywood and marked a line following the track. This made a new lift-out section about 5 inches wide. This was cut out with a jigsaw.

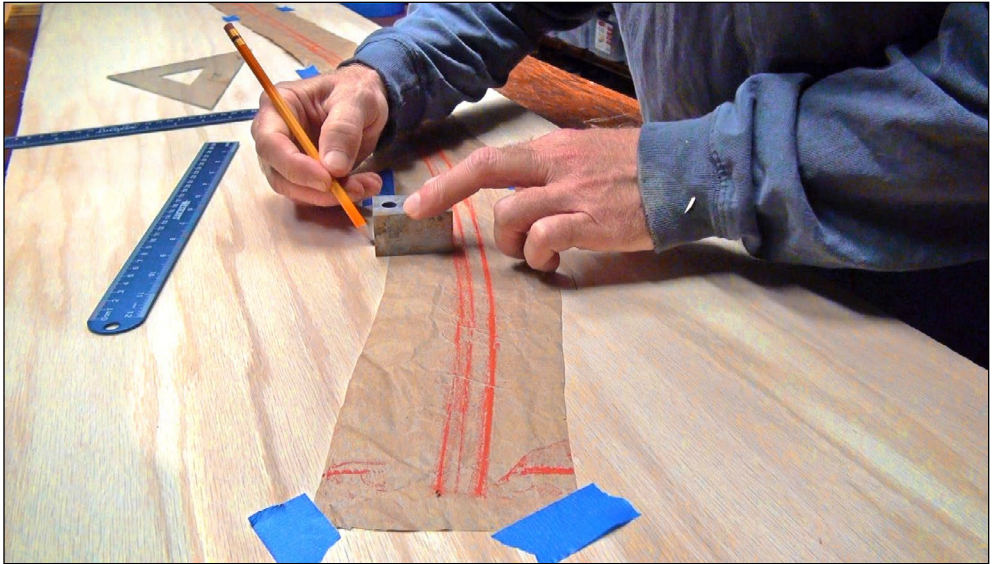

★★★★★
RATE THIS ARTICLE

• [INDEX](#)



SUBSCRIBE
(free)

• [TABLE OF CONTENTS](#)



4. I test-fit the wood section into place and used 1x4 pine as a riser, placing it atop my existing woodwork. This made the track line up perfectly with regards to rail height. I used another piece of 1x4 lumber, centered between the door hinges, to make a lap joint to prevent the section moving. I did this to each end of the lift-out, gluing and clamping the unfinished wood together.

**VIEW READER
COMMENTS**

[click here](#)



Also see the new "What's neat this week" weekly video podcast!

**WATCH
NOW >>**

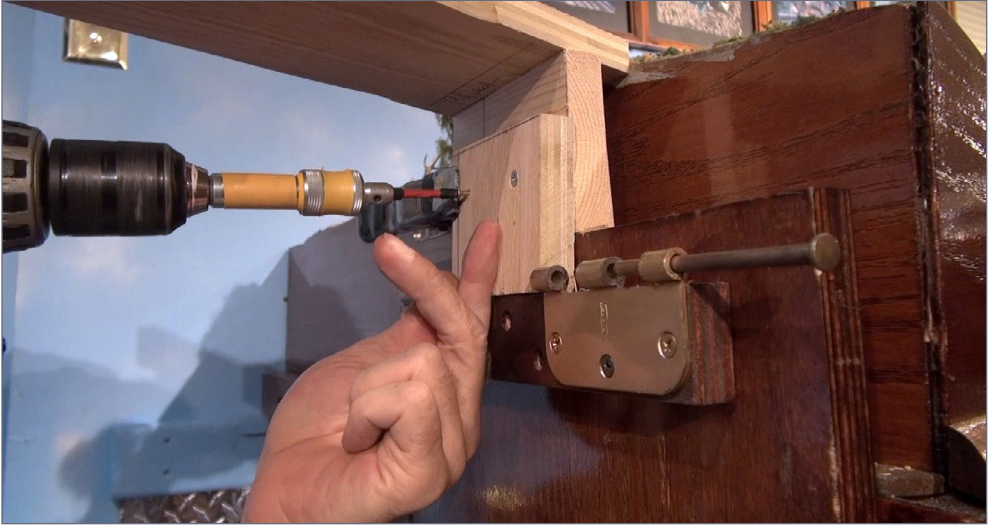

5. I used wood screws to join the lap joint and attach the $\frac{3}{4}$ -inch plywood to the 1x4 riser. I then drilled two $\frac{3}{8}$ -inch diameter holes in the 1x4 and the existing stained plywood, about 3 inches apart.





6. These holes will be the attachment points, using 3/8-inch steel pins about 2 1/2 inches long I found at my local True Value hardware store.



7. These pins fit through the holes, making for a very solid attachment point to the existing stained 3/4-inch plywood fitting between the old door hinges. The pins easily pull out with the help of a metal ring pull that your finger fits into.

Have you seen this?

**CHECK IT
OUT!**



kenpatterson.com

click here to ...

Visit Ken's website

**Ken Patterson
reveals his modeling
secrets on video!**





8. Moving back to the workbench, I cut two strips of $\frac{1}{4}$ -inch plywood to form protective walls $\frac{3}{8}$ -inch-high along both sides of the main. This was glued with wood glue and screwed in place with $\frac{3}{8}$ -inch metal screws.

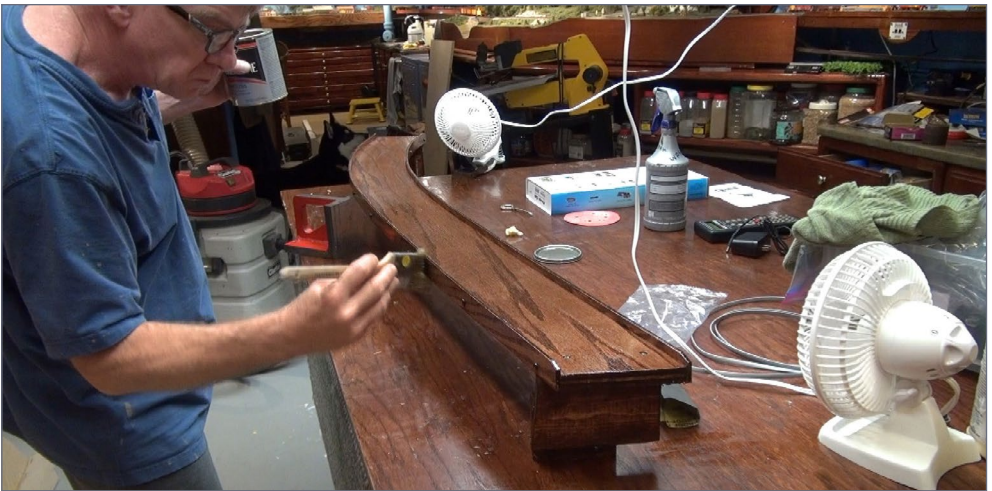

9. I stained the wood to match my layout room and then applied 4 coats of polyurethane, wet sanding between coats for a smooth finish. This will seal the plywood to prevent it from warping or sagging due to humidity.



10. I soldered together two 3-foot pieces of flex track. I carefully bent this to match the flow through the scene, then glued the track in place with DAP Quick Seal flexible adhesive applied with a painter's knife. I pressed the track into this glue, carefully matching the ends to the existing track and let this dry for about 2 hours.

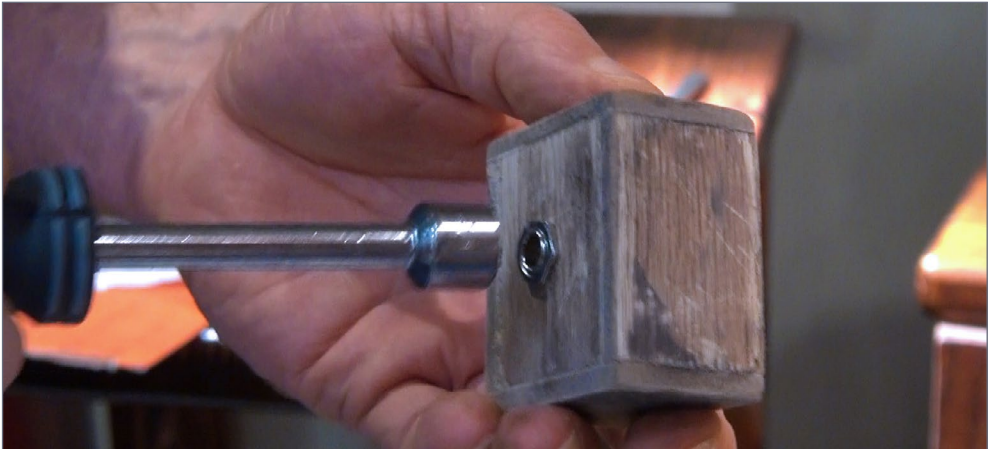

11. While the track glue cured, I built a small wood box from scrap pieces of $\frac{1}{4}$ -inch oak. I then drilled a hole in the box to accept a 2-conductor microphone female jack.



12. I drilled two holes in the lift-out section to run power wires from the rails through the $\frac{3}{4}$ -inch plywood, feeding the wires into the small wood box and soldering the leads to the microphone jack solder tabs.



13. The wood box was glued up under the lift-out section. The male microphone jack simply plugs in, providing track power to the section.



14. I ballasted the track with Woodland Scenics gray fine ballast, using an artist's brush to work the ballast into the ties. I then dripped Scenic Cement onto the center of the track, letting it soak the ballast from the center to the outside edges. When the glue dried, the ballast was attached rock hard.



15. And with that, I have an easy to install and remove lift-out section where the rails line up perfectly. It is so easy to duck under I may hardly ever have to remove it. It's held in with steel pins with no wiggle or side to side movement.



Large scale auto racks



16-18. In this month's video, I share these wonderful large-scale auto rack models in a two-minute segment with photos and video using a 12-foot-long double track diorama. The track is superelevated through the curve using Micro Engineering G scale 6-foot sections of track. The USA Trains auto racks are 1/29th scale and measure about 3 feet long.

While these models would look fantastic running along on a large garden railroad, they would look equally good displayed in a layout room or on a fireplace mantle. These bi-level racks feature details like see-through panels, chain brake rigging, and end doors that open to reveal great interior details.



Also see the new "What's neat this week" weekly video podcast!

**WATCH
NOW >>**

WHAT'S NEAT | 12



• [INDEX](#)



[SUBSCRIBE](#)
(free)

• [TABLE OF CONTENTS](#)

Ron Pare's Chinese building



19-20. (Above, top right) In this month's What's Neat video. Ron Pare takes three minutes to share how he went about scratch-building this building from China in HO scale. Using prototype photos, Ron captured the home-made architecture where square walls were secondary to the goal of adding stacked living space.

Ron makes the tile grout by mixing dirt and water in a bucket. He pours off the water, leaving a fine sediment that he lets dry over a period of days. He uses the very dry sediment to make grout for the 12-inch tiles. He made the stucco cement walls by spreading a layer of "Tacky Glue" and pressing his dry sediment into this, allowing the glue to soak into the fine dirt. When it's dry, he has a perfect stucco effect.



Also see the new "What's neat this week" weekly video podcast!

**WATCH
NOW >>**



ADVERTISEMENT

END OF TRAIN DEVICE

NEW SAFETY GREEN



**Bright Red
Flashing Light!**

Installs in minutes!
No freight car
modification required!

Patented Technology - US Patent 7,549,609

Does not affect Load!

↓ Car without Load ↓

↓ Car with Load ↓



**Click Here to
Learn More**

RE RING[™]
ENGINEERING

• [INDEX](#)



SUBSCRIBE
(free)

• [TABLE OF CONTENTS](#)

Bill White's G scale indoor layout



21-24. (Above, top right) I visit Bill White's large-scale indoor layout, where super-detailing takes precedence over operation. Bill just loves to build models. In large scale, models need to be more detailed as things are easier to see. He has captured the rugged landscape of a mountainous narrow-gauge railroad without having any grades.

The scenery, including the structures, is vertical yet the track is smooth and flat making for reliable running without drawing much power or running the risk of the heavy models stalling. Bill has modeled this layout for the run-by effect. He loves to just let the trains run. The pine trees are scratchbuilt, as are the bridges and many of the buildings.

Bill uses paper brick for some of his structures. It looks very realistic as background flats. His benchwork is 4 feet high, perfect for viewing locomotives and freight cars that can be as tall as 8 inches. Be sure to watch this month's video, where you can see the trains running along with steam-powered generators you can see through the windows of his gold mine complex.

WHAT'S NEAT | 16



• [INDEX](#)



SUBSCRIBE
(free)

• [TABLE OF CONTENTS](#)

Steve Mann's operating C&NW HO layout



★★★★★
RATE THIS ARTICLE



25-27. (Left top and bottom, above) This month, Steve Mann shares his basement-filling HO scale Chicago & North Western operating layout. This double-decker layout is so big he has strip mining operations with run-through coal trains that load at a twin tower facility. He hides the steel posts supporting his house by building the coaling towers around the beams. He has lots of switching, with a meatpacking plant and multiple grain elevators.

Steve's mainlines are long between towns with passing sidings for trains of more than 50 cars. His lighting is neat in that he disassembles 4-foot shop lights and stacks the sides end to end, getting 8 feet out of a 4-foot fixture. His operating sessions require 6 to 8 operators and last about 4 hours. There are miles of mainlines to see in this month's 5-minute segment on Steve's layout in the What's Neat video. Be sure to leave your feedback in Reader's Comments about this wonderful layout.



Also see the new "What's neat this week" weekly video podcast!

**WATCH
NOW >>**



2003

Celebrating 15 Years!

2018

OF TRACK BUILDING INNOVATION

FAST TRACKS

Build your own trackwork easily, quickly, and affordably.

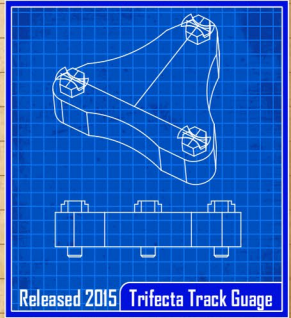
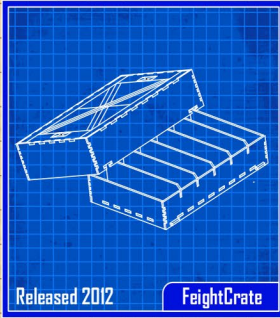
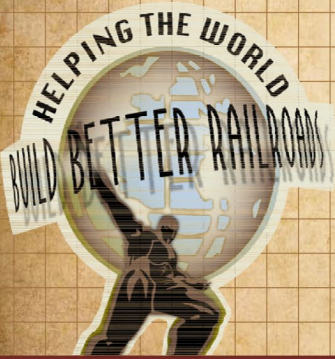
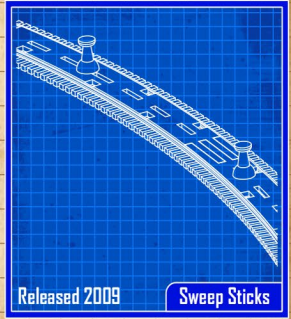
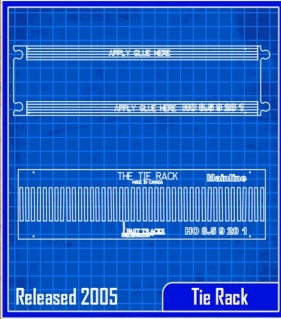
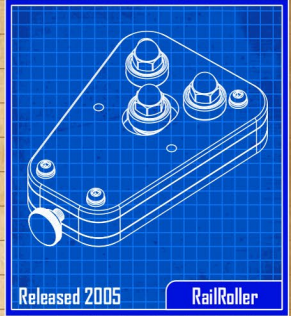
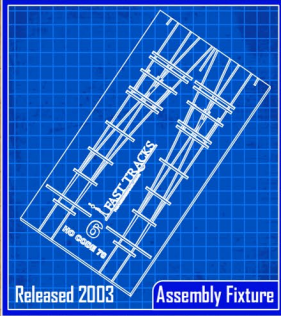

Easy ordering • Live online support • Earn Waypoints with every purchase

shop online 24/7 handlaidtrack.com

1-888-252-3895 service@fast-tracks.net

• [INDEX](#)

• [TABLE OF CONTENTS](#)

IMAGINEERING

column



Model Railroad Hobbyist | July 2018 | #101

DAVE MEEK REVIEWS POPULAR
MODEL RAILROADING RULES AND
HOW HE BROKE THEM WITH CLEVER
NEW SOLUTIONS ...



BREAKING THE RULES

WHEN IT COMES TO IMAGINEERING A MODEL railroad, rules are made to be broken. Imagineering is all about creative problem-solving. You start with an idea, then use all of the skills, materials, and imagination at your disposal to make that idea real.

There may be rules and guideposts to follow on that creative journey; conventional wisdom handed down from those who went before to help you along the way. But it's important to know when and where you can break those rules, especially if they are standing in the way of the results you want.

Sometimes you have to strike out on your own into unknown territory, casting conventional wisdom aside. That's what creativity is all about! Knowing how to break the rules (and get away with it!) is an important step towards mastery in any creative endeavor, and model railroading is no different.

▶ [EXPLORING THE CREATIVE SIDE OF THE HOBBY](#)

• [INDEX](#)



[SUBSCRIBE](#)
(free)

• [TABLE OF CONTENTS](#)

Drawing on my own experience, what follows are a few examples of handed-down, conventional-wisdom type model railroading rules, and how and why I choose to break them. I'll leave it to you to decide whether I got away with it or not.

RULE ONE: ALWAYS WORK FROM A PLAN

“The way to get started is to quit talking and begin doing.”

– Walt Disney



1. Some of the more interesting models on my On30 Thunder Mesa Mining Co. layout were built on the fly without much of a plan at all. Vertical-boilered engine #1 and caboose 92 were both put together from sketchy ideas using mostly what I had lying around.

I like a good plan as much as anyone – heck, I’ve drawn hundreds of them! Track plans, structure plans, rolling stock plans, you name it. But some of my most interesting and creative models have actually been the result of building on-the-fly. Working without a net and just trying things to see what worked.

You can call it “planning-as-you-go” if you like, but there is something very liberating about just putting things together and letting the creativity flow. [1]



2. This lineside water tank started as a Banta Modelworks kit. About halfway through the build I decided to replace the flat roof that was designed for it with a scratchbuilt peaked roof. Kitbashing breaks the rules by tossing out the directions and using the materials of the kit to make something new.



An artist sees everything as raw materials. Kits, parts, junk, broken bits, cardstock, paper, wire, wood, brass... you get the idea. It's all in how you put it together. A plan might be great for getting started, and I highly recommend following the instructions if you're new to building models. But there comes a point where you can trust the skills you've acquired to see you through.

Remember, most kits were designed by modelers much like yourself. Don't be afraid to stray off the beaten path. Who knows? You just might come up with something creative, new, and original. [2] Even when modeling a specific prototype, you might come up with a better way of doing things. After all, this is how every new idea in the hobby came about.



3. The Thunder Mesa Mining Company as seen from above today. Though many plans have been drawn and redrawn, the layout has taken on a life of its own as new possibilities became apparent during construction.

It's not just models or scenery. I tend to draw very careful, intricate track plans, and then deviate from them almost immediately once actual construction begins.

This is because I always see new, often better possibilities that never occurred to me during the planning process. Tracks are rerouted, entire towns get relocated, mountains and canyons switch places, lineside industries change – all as scenes evolve and take on lives of their own. [3] Planning is very helpful and can be fun, but there is no substitute for actual *doing*.

Over-planning can be a trap too. We've all know modelers who get so caught up in the planning process that very little ever actually gets built. Armchair modeling can become a sort of creative paralysis in extreme cases.

You can spend years and years planning your dream pike on paper when you might be better off just getting started on a small section or module. So what if it's not perfect? You'll be learning and honing skills by actually building something.

RULE TWO: KEEP EVERYTHING IN SCALE

We are dealing with scale model trains here so it should be a simple matter of picking the scale you prefer, like 1:87 or 1:160, and then making sure all your equipment conforms to those formulas. That's the theory anyway, and it works for the most part, but in practice will only take you so far.

I work primarily in O scale, 1:48, and having everything look like it's in scale at $\frac{1}{4}$ " to the foot is always my goal. But the important qualifier in that sentence is "look like." No matter what scale you model in, it's important to know where you can fudge the scale of things to make models that are more visually interesting.

Scale refers to the relative size of things, and it is the actual size of the bits and pieces and detail parts you model with that matters



far more than any official scale that might be stamped on the box. Remember, creative people view everything as raw materials. An HO scale brake wheel might make a perfect valve handle in O scale, while supposedly N scale trees can be ideal saplings or bushes in HO.

Scenery is an obvious place where scale is often relative. One scale's ballast is another scale's boulders, after all. Basic building materials like stripwood or sheet styrene are also scale-relative.

An O scale 1x3 is darn close to an HO 2x6. Close enough anyway. Just as big bricks in HO are little bricks in O. The point here is not



4. Strictly speaking, this may be an O scale scene, but not everything is modeled at $\frac{1}{4}$ " to the foot. The mine on the hillside is slightly smaller than scale to blend with the rockwork that also uses forced perspective to make the butte seem taller than it is. The tiny Shay in the distance is not as far away as it seems. It is an On18 model running on 9mm - N gauge - track.

to get hung up on the scale of your materials, but rather to look at the size of things. If it works visually, use it.

Most model railroaders are also acquainted with the concept of forced perspective. This is a perfect example of breaking the scale rule to artistic effect.

In reality, things that are farther away look smaller to the human eye, so it naturally follows that if we place smaller-than-scale things in the background of our modeled scenes, they can trick the eye into seeing them as full scale items that are farther away.

The illusion is most effective when scenes are modeled at or near eye level and, when done well, is very good at simulating greater depth and distance. [4]

The flip side of traditional forced perspective is modeling structures slightly larger than scale if they are just below eye level and in the foreground. This is advanced rule-breaking that can lead to some very charming and appealing models.

I don't know of many other modelers that do this – Thomas Yorke comes to mind. Most of the scratchbuilt foreground structures on my Thunder Mesa layout have an extra scale foot or two of height added to make them more appealing. This “reverse forced perspective” is a visual trick that compensates for the way our eyes tend to flatten out model structures when viewed from above. [5]

All this is to say, don't be afraid to break the rules of scale now and then, especially for creative or artistic effect. Trust your own eye and look at the size of materials first before worrying about scale. Experiment!

After all, it was a willingness to play around with scale that gave us creative mash-ups like On30, On18, and HOn30. [6]



RULE THREE: ALWAYS STRIVE FOR REALISM

In recent decades there has been a relentless drive toward ever more realistic models and this has mostly been a very good thing. Few can look at an RTR locomotive model from the 1970s with its pizza-cutter wheel flanges and crude, molded-on details, and say that it is a superior model to the smooth-running, well-detailed, electronic marvels available today. No indeed!

Within the hobby, saying that a model looks realistic has largely become synonymous with saying that it is good. And the inverse is also true: Models that don't reach a high bar of realism are often considered poor.



5. The undertaker's parlor next to Boot Hill is a good example of reverse forced perspective. This foreground model was built slightly taller than scale to accentuate its gothic appeal.

SUMMER
SPECIAL
PRICING IN EFFECT

TMTV: WHAT'S NEW!



Expanded DCC
lighting functions



Better Kadee coupler
performance



Effective paint
masking



Roger Chrystler's
Lake Erie & Northern

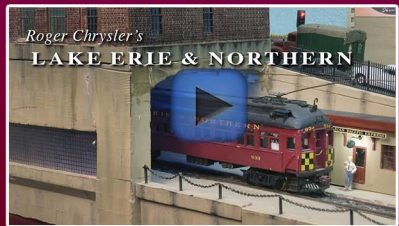

Summer special
pricing in effect!



Become a
TMTV member



MRH Subscriber? Save ANOTHER 10%:

Get Subscriber
10% off code

• [INDEX](#)



SUBSCRIBE
(free)

• [TABLE OF CONTENTS](#)

That's the rule. But when we approach the hobby of model railroading as an artistic endeavor, some different rules apply.

In art, realism is a stylistic choice, not an arbiter of quality. Quality has much more to do with how well the artist presents their vision while stylistic choices remain of secondary concern.

I don't want to get too far out into the philosophical weeds when it comes to our hobby, but I will go so far as to say that realism might better be viewed as a tool for our modeling, rather than its ultimate goal.



6. Shay #3 takes the siding up in Big Thunder Camp. On18 uses N scale mechanisms and 9mm gauge track to model this common industrial and mining gauge in 1:48 scale. It was invented when someone looked beyond the rules of scale and wondered what would happen if you mixed O scale with N gauge.

Think about it. Even the most painstakingly detailed, beautifully painted, weathered-to-perfection, down-to-the-last-rivet, contest-winning Proto 87 steam locomotive still runs on electricity, not coal-fire and steam.

Is that really the ultimate in realism? Or does it just use realism very well to tell a good story about steam trains in miniature? I believe it's the latter. Realism is a stylistic tool that we all use to different degrees, depending on the railroad stories we are trying to tell.

I made a stylistic choice very early with my On30 Thunder Mesa Mining Company layout that I would strive for a certain level of believability rather than a strict adherence to realism.

The realism rule had to be broken in order to tell the particular story I was most interested in telling. Some might call what I do fantasy modeling, but I prefer to think of it as rip-roaring fiction. [7] The kind of tall-tale Western we all used to suspend our disbelief for during a Saturday matinee.

A willing suspension of disbelief is all that's really required to get a fantastic story across. What we see has to seem plausible, believable, *within* the world of the story, with little bits and pieces of realism salted in as visual cues to make that easier.

If I had wanted to tell a more documentary style story about Western mining at the end of the 19th Century, I might have picked an actual prototype like the United Verde & Pacific in Jerome, AZ, and used a much heavier seasoning of realism to better fit that subject matter.

Instead, I chose to tell a completely freelanced story that takes place "Once Upon a Time in the Wild West." With either choice, realism becomes a tool, not a rule, and the degree to which one uses it depends entirely upon the story being presented. [8]



RULE FOUR: YOUR MODEL RAILROAD SHOULD OPERATE LIKE A REAL RAILROAD

We've all been told that realistic operations are an ultimate goal to be aspired to in model railroading. Some have even gone so far as to claim that is the only goal worth aspiring to, and that anything less is merely "playing with trains." To them I say, "What's wrong with playing with trains?"

Truth is, we are all just playing with trains in one form or another. What is "realistic operations" but a sophisticated, railroad themed role-playing game?

The reasoning behind this rule is understandable. It's an outgrowth of the over-arching ideal of realism discussed above. Plus,



7. There is a jackalope and a T-rex skeleton in this scene. Hardly what most modelers would describe as realistic, but it works if it is believable within the context of the Thunder Mesa story.



8. If the story is, “Once Upon a Time in the Wild West,” then the rules are quite different than if one is modeling a specific prototype. The amount of realism we salt into our scenes depends on the visual cues needed to get the story across.

the game is fun, and having a model railroad that can operate realistically requires that it also operate near flawlessly.

Unless you want to constantly be bringing in the ol’ 0-5-0 (your hand), all the moving parts need to work really, really well. This is a worthy, challenging goal, one that can require many years and many skills to achieve.

However, you can also play the game with nothing more than a pencil and paper, a clock, and a little imagination. Or you can play it as a video game. You don’t need structures, scenery, lights, animation, sound effects, or even trains and track for that matter.

You don't need a model railroad at all to role-play at railroad operations! Which brings me to my main problem with this bit of conventional wisdom: It implies that the railroading game is more important than the modeling itself. It also implies that we should all find our enjoyment from the hobby in precisely the same way.

If you are building a model railroad with the ultimate goal of realistic operations in mind, you have my admiration and respect. It's a tough thing to pull off well.

But from a creative standpoint, it might be better to think in terms of enjoyable operations or *entertaining* operations. This allows room for all of the other aspects of the hobby that make it such a rich storytelling medium. [9] [10]



9. This area of the layout is still under development, but the tunnel portal near the backdrop will eventually lead to a four-track staging yard with reverse loop. When completed, it will be possible to operate the layout in a realistic point-to-point fashion, but more importantly, it will greatly increase the entertainment value of the layout by adding the ability to bring different trains on and off stage.



10. Another area currently under development is this canyon of balancing rocks. Eventually they will animate, moving and swaying as the trains pass by. This may contribute exactly zero to “realistic operations,” but it will add a great deal to enjoyable and entertaining operations.

Telling a good story with model trains, whether it be fact-based or imagined, requires a broader view than simply building for operations. Planning and building for maximum entertainment is at the heart of imagineering. And this brings me to my one unbreakable rule.

MY RULE: A MODEL RAILROAD IS ENTERTAINMENT

That’s right, it ain’t rocket science. We, all of us who build layouts, dioramas, and modules, are engaged in the time-honored practice



of storytelling – even if we don't realize it. That scale model trains are the medium of choice makes no difference.

Just like a book or a movie, we start with a who, what, where, when, and why, and launch our tales from there. My only unbreakable rule is that the story be as entertaining as I can make it. [11] [12] [13]

Accomplishing this requires planning, but also trusting in one's skills and instincts enough to keep moving forward when plans change or



11. At Thunder Mesa Studio, a couple of walls adjacent to the layout are decorated with artifacts that help introduce guests to the wild-and-woolly backstory of this fictional world. Not every modeler has the room (or desire) to create something so elaborate, but freelancing is world-building, and my rule says that the world must be entertaining.



12. This speaker below Big Thunder Creek plays a continuous loop of rushing water and wildlife sounds. There are several others hidden around the layout that play various sounds, all adding greatly to the entertainment value of the railroad.

fall short. It requires an eye for scale and knowing what looks right even when it might be technically, mathematically wrong.

It requires research and understanding of real-world prototypes to know which bits and pieces are necessary to make a model believable within the context of your miniature world. And it requires an understanding that the ultimate goal is to tell a compelling story, not just to move imaginary things around from point A to point B.

I'm not writing this to be contrarian, but to encourage creative thinking. If you're new to the hobby, things can get a little confusing, even discouraging at times.



On the one side you may have someone encouraging you to “model the mundane” because that is more realistic in their view, while I’m over here waving my arms and shouting for you to cut out the boring parts and be as entertaining as possible.

The point is, nothing original was ever created by someone who followed all the rules. Creativity requires challenging the accepted maxims, and sometimes, going off on your own.

It’s been said that model railroad hobbyists can be broken down into two types: the engineering type, and the artistic type. The “engineers” prefer formulas and precise guidelines for everything



13. Only the NCE Powercab pictured here is for running trains. Everything else on these panels is for lights, sound effects, and animation to make operations more entertaining, immersive, and enjoyable.

from tracklaying to scenery painting, while the “artists” take a more seat-of-the-pants approach, relying on their eye and imagination to tell them what works and looks right.

It’s true that we all have our leanings, but some engineers are true artists and some artists can actually engineer. As a blending of imagination and engineering, imagineering implies a balance between these two mindsets; an artist to envision something compelling and original, plus an engineer to make it all work. Both types of skills are needed to tell a good story.

When it comes to breaking rules, think like an artist, but build like an engineer.



Did you know ...

MRH subscribers

SAVE 10%

**... on the MRH Store &
on TrainMasters TV?**

Click to get 10% off coupon code

(Must be a subscriber to access)



MRH MARKETPLACE



Imagine that!
Laser Art Products

ITLA Scale Models

Cooper's Alley

HO Scale - Precision Laser Cut Wood Kit



CLICK HERE FOR MORE INFORMATION
www.itlascalemodels.com



Yarmouth Model Works

HO scale resin kits and detail parts

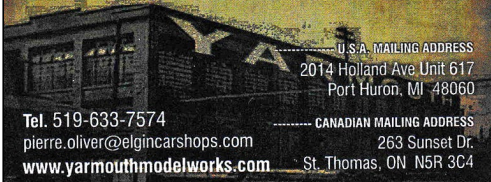

..... U.S.A. MAILING ADDRESS

2014 Holland Ave Unit 617

Port Huron, MI 48060

Tel. 519-633-7574

pierre.oliver@elgincareshops.com

www.yarmouthmodelworks.com

..... CANADIAN MAILING ADDRESS

263 Sunset Dr.

St. Thomas, ON N5R 3C4

CROW RIVER PRODUCTS

HO Scale Kits 214 & 215

Kit 214 Stiff Leg Derrick Features Wood Pewter and Photo Etched Brass Parts

Kit 215 Hoisting Shed cast resin Construction
Interior details includes profile boiler and a three drum hoist that can be connected to the derrick

Kit 214 Derrick \$60.00

Kit 215 Hoisting Shed
\$55.00

Made In USA

Both Kits shown together



**HO & O Scale Machinery, Derricks,
Engines, Hardware & Waterfront Models**
Pawtucket, RI 02861 Tel 401-723-0065
www.crowriverproducts.com

W GOLDEN AGE LINE
WESTERFIELD
MODELS, LLC

**USRA DS Express Box
NWP Redwood Empire**



westerfieldmodels.com

• [INDEX](#)

• [TABLE OF CONTENTS](#)

LOOK
at what's new at
Black Cat this month

Click here for
our website

CNR 1960-1961 era
"No Leaf" - wafer only
caboose
lettering



Black Cat Publishing
(204)489-5005
ajfergus@mymts.net
blackcatdecals.com



MONASHEE
LASER
ENGINEERING

COME VISIT
US HERE

MANUFACTURERS OF FINE RAILROAD
STRUCTURES AND ROLLING STOCK MODEL KITS

IF WE CAN DRAW IT ...

MAIN STREET AMERICA
HISTORIC ARCHITECTURE



**MAIN STREET
HERITAGE**

www.mainstreet-heritage.com

CLICK
HERE
for all
our HO
& O kits



LOGIC RAILTM
TECHNOLOGIES

"Sophisticated
Model Railroad
Electronics"



Please visit our website and online store!

21175 Tomball Pkwy
Suite 287
Houston, TX 77070

Phone: (281)251-5813
<http://www.logicrailtech.com>
info@logicrailtech.com

Great Decals!TM
FEC, Interstate, Virginian
Railway, & L&N Titles
After Hours Graphics Line
Coupler Gages and More
In O, S, HO, and N Scales

PRE-SIZE
MODEL SPECIALTIES

P.O. Box 6 Paonia, CO 81428

Ph. 970 527 4586

Made in The USA

Cast resin items for All Scales.

Tunnel portals, bridge piers, abutments,
culverts, and retaining walls.

Trackside details and sage brush tree
armatures.

"FREE SHIPPING see website for details"

• [INDEX](#)



SUBSCRIBE
(free)

• [TABLE OF CONTENTS](#)

Have you seen these popular blogs on the MRH website?



Tom Johnson's L&IN

381,000 reads

CLICK TO READ IT NOW

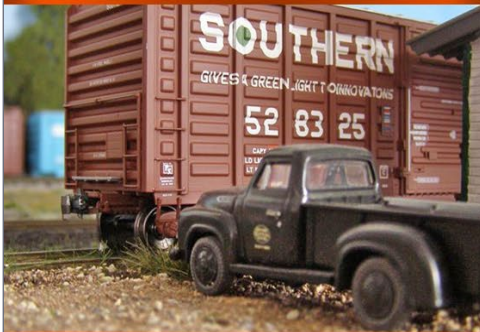

Ken Glover's Shelf Layout

147,000 reads

CLICK TO READ IT NOW



MasterpieceModules.com

T-trak Module Kits & more
CNC machined precision finger joints
parts are self-locating & self-clamping
All hardware is included

Model Railroad Control Systems

Geoff Bunza Project Boards
DCC Occupancy Detectors
CMRInet Compatible Nodes
Layout Telephone Systems
RFID Switchlist Generator
Switch Machines and Drivers



MOUNTAIN SUBDIVISION HOBBIES

www.modelrrsupply.com

FREE USA SHIPPING OVER \$39.00

NCE - SOUNDTRAXX - DIGITRAX - ESU LOKSOUND
SPROG - DCC SPECIALTIES - INTERMOUNTAIN - CMX
BAR MILLS - BOWSER - ATLAS - CIRCUITRON - PECO
RIX - PIKESTUFF - CENTRAL VALLEY AND MORE!!!

PRECISION DESIGN CO.

LASERCUT KITS - CUSTOM DECALS

PDC.CA

Authorized *RailPro* Dealer

FREE SHIPPING in the US and CANADA

HO DIESEL SUPPLY

CUSTOM SOUND LOCO'S-REPAIRS-UPGRADES
Weathered New and Rebuilt Locomotives
Powered Chassis-Trucks-Motors-Handrails-Electronics
Parts Inventory Always Changing

www.hodieselsupply.com

email:gerry@hodieselsupply.com

LAST CALL!

FINAL KIT!



FINE SCALE MINIATURES

FSM is closing its doors after 50 years of business!

Shown is our final kit built by Frank Bernard. As you can see Frank did a masterful job. We still have a few kits left, but hurry!

Model by Frank Bernard



ONCE GONE, THAT'S IT!



Model by Frank Bernard

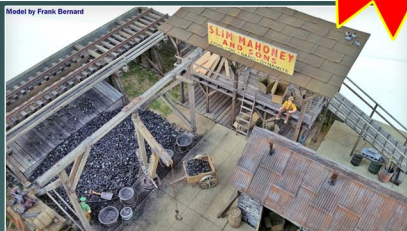

Model by Frank Bernard

I.M. Dunn Co.
\$280 + S&H



Destined to become an instant collector's item

BUY NOW >>

Brought to you by the MRH Store: store.mrhmag.com

• [INDEX](#)



SUBSCRIBE
(free)

• [TABLE OF CONTENTS](#)

Modeling a **Rock Island U25B**

Model Railroad Hobbyist | July 2018 | #101

★★★★★
RATE THIS ARTICLE

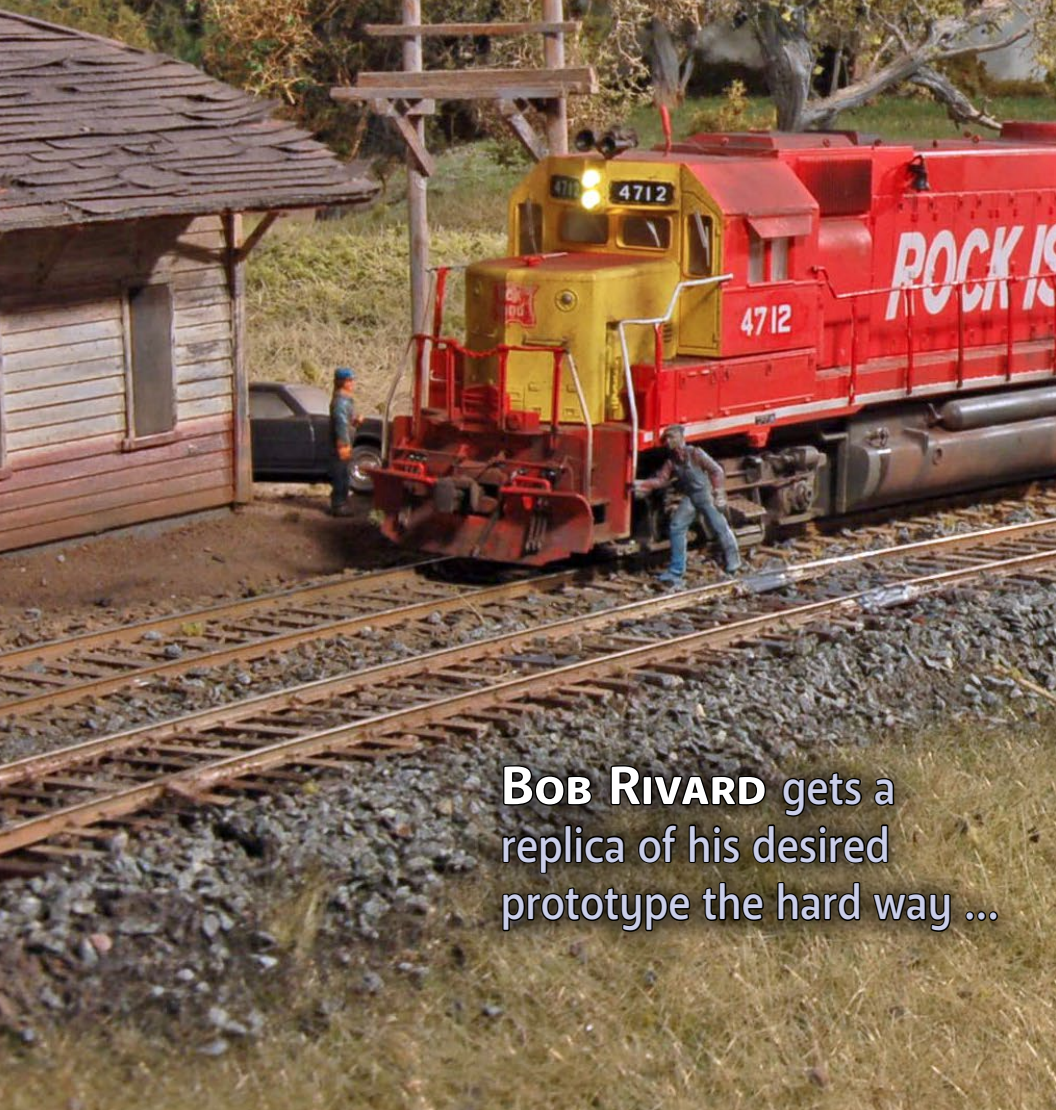

BOB RIVARD gets a replica of his desired prototype the hard way ...

• [INDEX](#)

• [TABLE OF CONTENTS](#)



Here is the finished 250 behind 4712 and leading unit 223 at the Cardigan Junction depot.

LAST YEAR, AS I WAS SCANNING MY 35 MM SLIDES I stumbled across a couple of shots I had taken of a Rock Island train. This train, known as the Rocky-Soo transfer, ran daily from the Rock's Inver Grove Heights yard in St. Paul to Shoreham Yard. Although the shots are far from being perfect examples of great photography, they are invaluable to me for a couple of reasons.

• [INDEX](#)



SUBSCRIBE
(free)

• [TABLE OF CONTENTS](#)

MODELING A ROCK ISLAND U25B | 3





1a. (Above) I run Rock Island power on my HO Soo Line railroad, based on photographic evidence I have in my collection [1b, 1c].

1b. (Left) I took this photo in 1977, the exact year I model on my HO Soo Line, and it shows Rock Island power running on my modeled area [1a].

MODELING A ROCK ISLAND U25B | 5



1c. There is more Rock Island power on this train I photographed in 1977.



2. A Rock Island Atlas GP 40 in the distance (4708) and the trailing unit, 223, which I had modeled using a Stewart U25B.

MODELING A ROCK ISLAND U25B | 6

First, I took the photos in 1977, which is the exact year of my modeling era [1b, 1c]. Second, they document a classic Rock Island power combination which operated on the exact section of the Soo Line that I model in HO scale [1a].

As I studied the three locomotives in my prototype photos, I knew I already had representations of two of the units in this lash-up [2].

As a bonus in trying to model the units on this train in the prototype photos –one of my models had the same number: 223 [3].

To correct the road number of the lead unit [2], I simply changed the road number on that unit from 4708 to 4712. Some wet sanding, red paint, and a quick visit to my Microscale decal scrap box made this possible.

One unit remained to model this complete three-unit lash-up -- Rock Island 250.



3. My model of Rock Island 223.



Modeling Rock Island unit 250

For most modelers, the first step in any project is to research the prototype. I found some helpful photos on the internet of the 250. The Rock Island Color Pictorial, Vol. 3 by Louis Marre provided helpful prototype information.

It turned out that the 250 was involved in a wreck in 1971 and, as Mr. Marre points out on page 93, “It’s a hard way to do it, but one route to the paint booth at Silvis, was by way of wreck repair.”

Thus, by the early ’70s, the 250 was wearing the new red speed lettering paint scheme.

The next step for this project was to obtain a credible model. I decided that the Bowser U25B model would be the best option for my project. I noticed a wonderful RTR model from Bowser’s



4. Here is my new Bowser Executive Line model complete with a Loksound decoder and lights.



5. Here is the correct split windshield cab for my model of Rock Island 250.

Executive Line at my local train shop. It even came equipped with a Loksound decoder.

Bowser painted the model in the older maroon and yellow scheme which would mean stripping and repainting it and although this was not a big deal, I figured I could come up with a closer option. In hindsight (as you will soon see), I wish I had purchased the hobby shop model, which was the correct “phase” for this project.

Instead I found a Bowser Executive Line model on E-bay. It was lettered for the California Oregon and Eastern railroad. It was even painted yellow and because of this I decided I could simply remove the lettering, mask off the yellow front and back and paint it red. Before I knew it, I had hit the “buy it now” button and my new acquisition was on its way [4].

MODELING A ROCK ISLAND U25B | 9

I started the process of taking apart my new model, so I could properly paint it. I soon ran into the first of many problems. My model was not the same phase as the prototype 250. Uh-oh.

I noticed on the internet photo of the 250 that my new model had a full windshield and not the correct split windshield required for

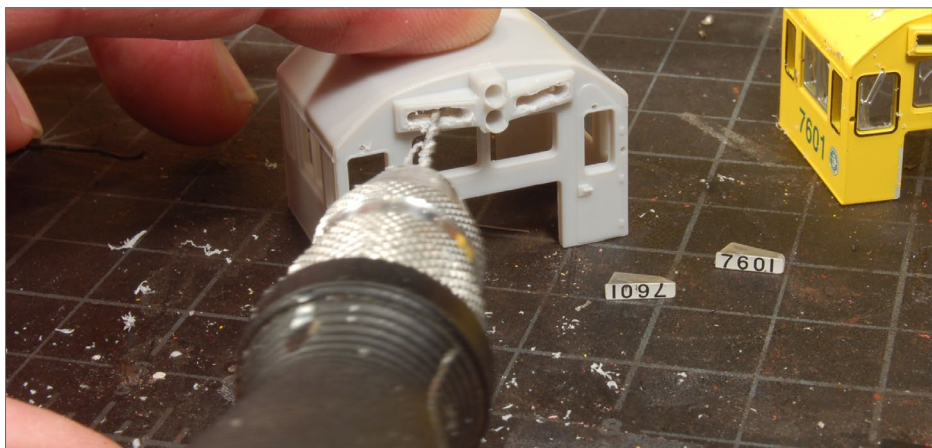

6. I hollowed out the cast number boards on my cab, starting with a drill in my motor tool.

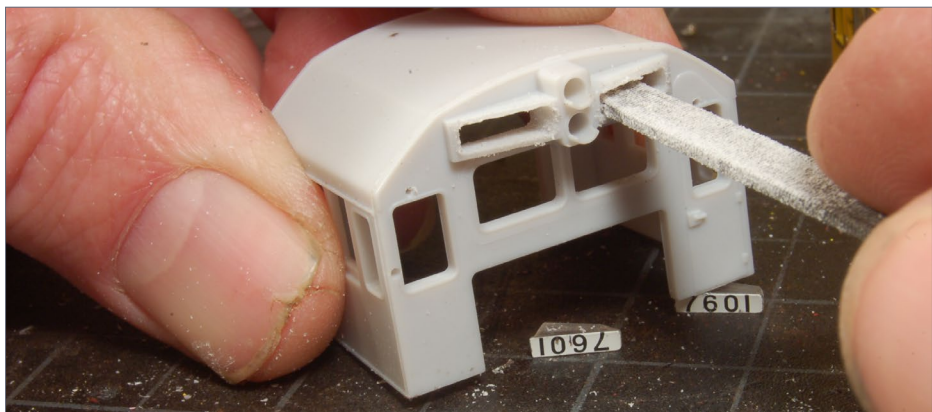

7. I finished opening the cab number boards using a small file, working slowly until the factory number boards fit perfectly.



8. New undecorated shell with the proper nose moved over to my CO&E body.

the 250. A call to Bowser was now in order. The person I talked to was very helpful – and the correct cab was on the way [5].

Unfortunately, the replacement cab was from an older Stewart model line without the lit number boards. If I wanted to use the Executive Line number board lighting, I would have to hollow out the cast number boards. I performed this task using a drill bit in my motor tool [6] and followed up using a small file [7].

I was now much closer to giving my model a coat of speed lettering red. As I was preparing the model for the paint booth I noticed another roadblock: my model had the wrong nose! Instead of a brake wheel, the 250 had a ratchet-style lever. Oops!

I once again called Bowser to see if I could obtain the correct nose. I learned the answer was indeed yes, but only if I purchased an entire undecorated shell!

MODELING A ROCK ISLAND U25B | 11

Once my new undecorated shell arrived, it was a simple matter to remove the nose and attach it to the original CO&E body [8].

My model was finally ready for a coat of Scalecoat II Armour yellow paint. However, before I painted my model red, I used my airbrush to prime the shell with Scalecoat II BNSF white.

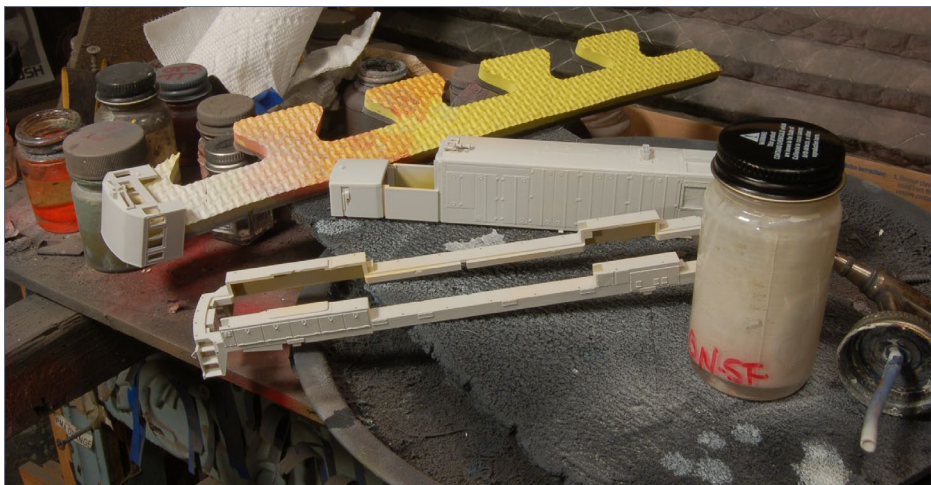

9. Giving the loco a coat of primer gray in my paint booth.



10. I airbrushed my yellow mix onto the nose and rear end. I also airbrushed yellow onto the front of the cab (not shown).



11. Shell and cab masked and ready for a coat of red paint.

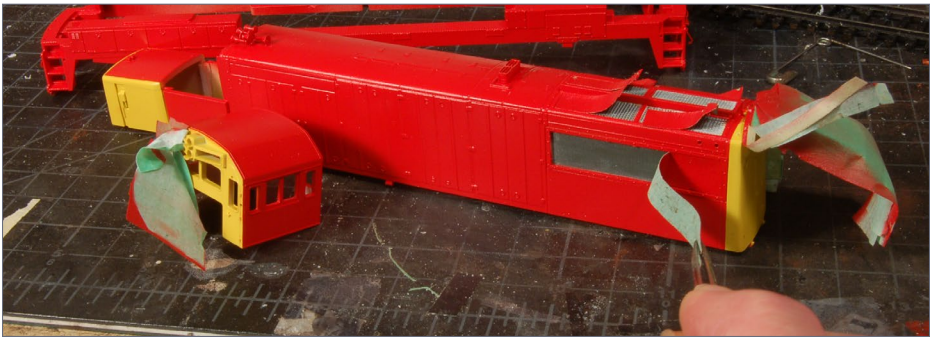

12. Shell and cab masked and ready for a coat of red paint.

Any shade of white or light gray will work as a primer coat. This helps the more transparent red and yellow paints to be rendered accurately [9].

Next step was to paint the Rock Island yellow ends. I decided to add about 5 percent white to UP Armour yellow for this [10].

After painting the ends and cab front yellow, I allowed the paint to dry before I masked off the areas to remain yellow on the finished

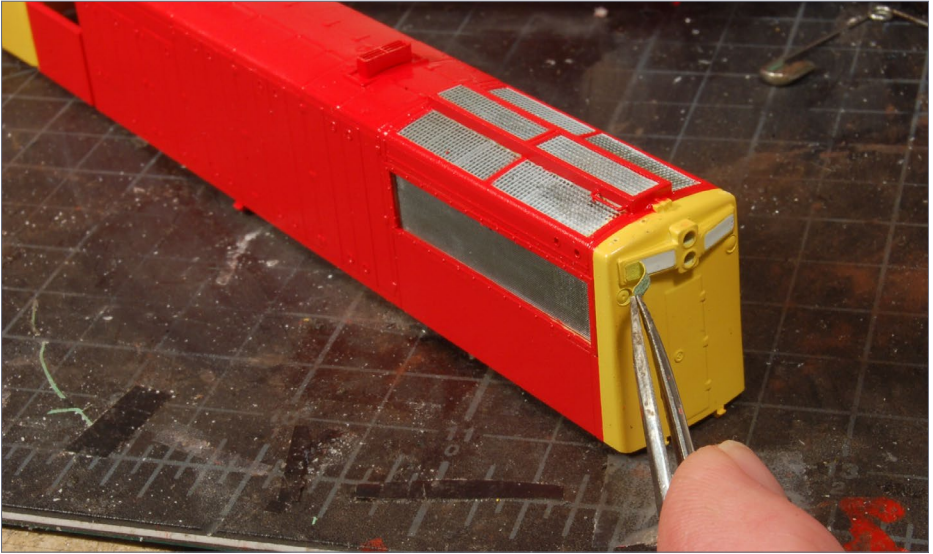

13. Taking the masking tape off the number boards.



14. Applying decals to the body.



15. Removing incorrect front pilot details using an X-Acto blade.

model. I also applied masking tape to all intake grilles and the white number boards [11].

I headed back to my spray booth to apply a coat of Scalecoat II Santa Fe red. I carefully removed the masking tape from the shell [12] and from the number boards [13]. I used Highball Graphics set 87-0218 “Rock Island GE diesels” to letter my model [14].

I next installed the hand-rails. As I studied the prototype photo of number 250, I was once again reminded of why I should have purchased that original factory Bowser



WRITE YOUR OWN INSTRUCTIONS

Before starting a project, study your model and prototype photos for details and differences. Make a list of changes needed and part numbers so you don't forget a step. This helps a lot if your work time stretches over several sessions.



model from my local hobby shop. I realized my model needed side-mount style hand rail stanchions instead of the supplied deck-mounted ones. This new obstacle was soon resolved, however.

As I was looking through my parts drawer I discovered a set of Utah Pacific brass GE stanchions. I used the original deck stanchion mounting holes as a guide to drill new mounting holes to install the new Utah Pacific brass stanchions.



16. New front pilot details match the prototype loco.

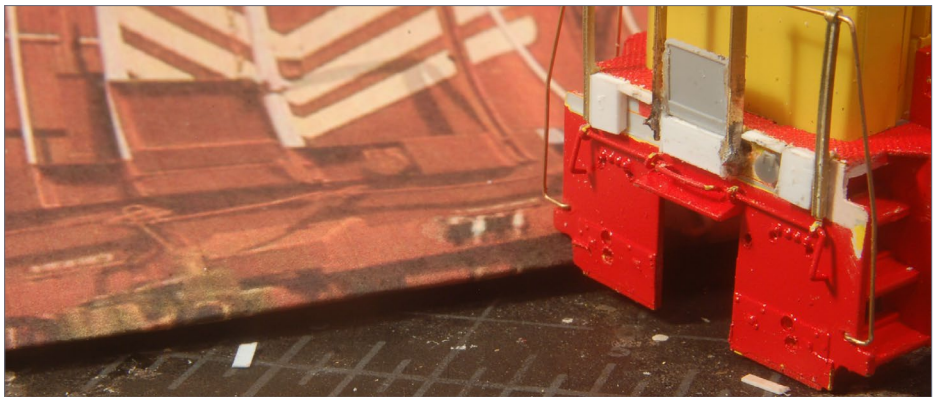

17. The finished front pilot on my model, ready for painting.

MODELING A ROCK ISLAND U25B | 16

I then headed back to the paint booth to apply a coat of Rock Island red onto my newly installed brass stanchions. For the handrails, I used 0.015" brass wire. As I started preparing to bend and cut the hand rails, I noticed on one prototype photo some detail items on the front deck area that were lacking on my model.

Before proceeding further with the handrail installation, I decided to model these details by using a number 17 X-Acto chisel blade to remove some of the existing cast details on my model [15].

I simply added a few bits of styrene to simulate the prototype's appearance. Next, I bent and cut the front handrails and coupler pin lifters from .015 brass wire. I also added a Details West GE drop step and a MU receptacle [16].

I noticed that the prototype photo indicates the two inward stanchions, next to the drop steps, should be flat. To duplicate these, I found a pack of Cary Alco brass stanchions which worked perfectly for this. The deck was ready to be touched up with red paint [17].



18. Attach the sunshade bracket. Also note the masking of some battery box doors to keep them free from weathering and simulate the freshly-painted look of these doors on the prototype.

I waited for the paint to dry before I reassembled my model. It is nearing completion, except for a few detail items. I attached a sunshade bracket cut from a scrap piece of Plastruct L-shaped styrene [18].

Before I started the weathering process on my model, I examined the prototype photo and noticed a few of the battery doors on the underframe had been replaced and had fresh paint. To simulate this detail, I applied patches of masking tape to cover these doors before weathering [18].

After I applied weathering I removed these masks. I also applied masking tape around the intake grilles. Performing this step captures the look of the prototype when I use my airbrush to apply weathering to the grilles [19]. Next I applied some engine black to the masked-off grilles using my airbrush [20].



19. Mask areas around the grilles for airbrushing.



20. Apply engine black to darken the grilles.



21. The finished grilles after removing the masking.



22. Weathering with Bragdon weathering powders.



23. Refer to the prototype photo as a guide for the weathering patterns.

Once the painted weathering had dried, I carefully removed the masking tape [21].

I decided that the best way to finish weathering my model was to use weathering powders [22]. I studied a photo of the prototype and then applied various colors of AIM weathering powders [23]. When I was happy with the look of the weathering on my model, I removed the battery door masks [24].



24. Removing the battery door masks.

**Please tell your
buddies about MRH!**



25. Here is the 250 at the east end of Cardigan Junction.



Finally, I cut a small piece of white stripe from the decal set and applied it to the battery box door. My model of Rock Island 250 was now finished and ready to be placed in service on the railroad.

I couldn't wait to give it a test run and hear that distinctive GE sound [25]. Wouldn't you know it, I encountered another problem. As I ran the model, I noticed that my model did not sound like a GE, but instead more like a Geep or F-unit!

I figured it was probably no accident Bowser offered this model with a 567 prime mover sound, so I turned to the internet to research the prototype California Oregon & Eastern Railroad's number 7601. I discovered that indeed this unit was rebuilt in the mid-seventies using the prime mover from a B&O F-unit! Fortunately, this new issue had a quick fix.

I simply headed for my Loksound programming track and downloaded the correct GE sound file to my model. My Rock Island GE now sounds like a GE. That's more like it [26].



**Want to help keep
MRH free?**

Then *click* on ads!

BOB RIVARD

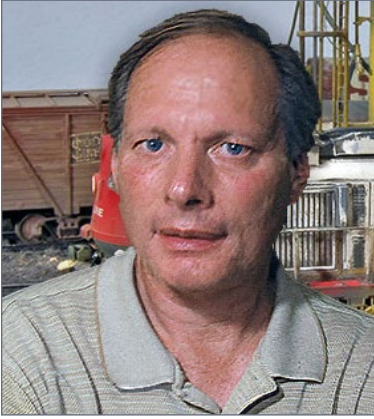

Bob Rivard has been fascinated with trains since the age of 5 when he received his first train set, the proverbial Lionel.

He really enjoys his job at KARE TV and has worked there for 34 years as a broadcast technician. He runs the robotic cameras during the 10 p.m. news. ■

ADVERTISEMENT

Plans by John Hall

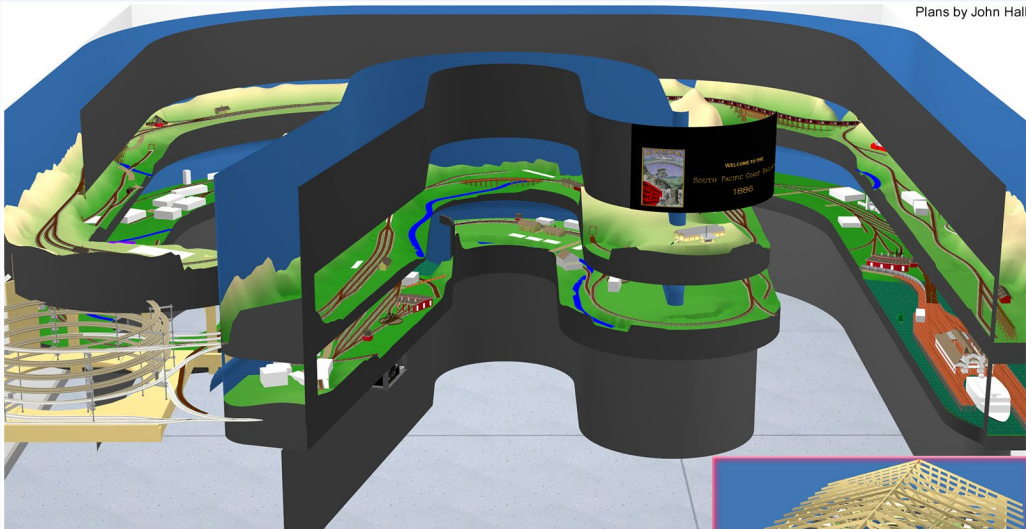

How will you plan your layout?

3rd Plant 3D CAD
The ultimate track planning software

El Dorado
SOFTWARE



Click Here!

• [INDEX](#)



SUBSCRIBE
(free)

• [TABLE OF CONTENTS](#)

ARE ZERO DERAILMENTS POSSIBLE?

YES! Besides TRACKWORK, there's good ROLLING STOCK.

(Book 1)

(Book 2)

Make it run like a

Dream

ROLLING STOCK

102 pages

By Joe Fugate

Available NOW!

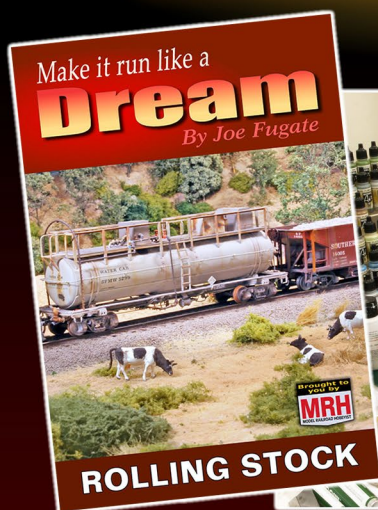

Click me to

GET eBook NOW >>

\$11.49

Format: Landscape and
Portrait PDF

Click me to

ORDER PAPERBACK >>

\$28.49

FREE shipping in US!
Foreign shipping 50%

• [INDEX](#)

• [TABLE OF CONTENTS](#)

Paperback

Content includes ...

~~\$29.99~~
\$28.49

FREE SHIPPING in US
Half-price shipping foreign

eBook

~~\$12.99~~
\$11.49

- Setting good standards
- Building a proper test track
- Wheelset/truck issues
- Coupler issues
- Carbody issues
- Car weight considerations
- Better maintenance procedures
- Useful preventative measures
- Problem diagnosis & repair
- Special little-known tips
- Helpful forms & checklists
- Covers all scales G-Z

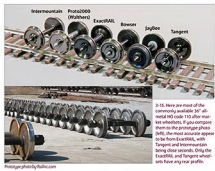

Wheelset This is where you'll find all the information you need to know about wheels and tires. It covers everything from the basic types of wheels to the more advanced types like the ones used on the new locomotives. It also includes information on how to choose the right wheels for your train and how to maintain them.

Page 12 Mini-Franklin-Bus-BREILING-STECK



Wheelset This is where you'll find all the information you need to know about wheels and tires. It covers everything from the basic types of wheels to the more advanced types like the ones used on the new locomotives. It also includes information on how to choose the right wheels for your train and how to maintain them.

Page 16 Mini-Franklin-Bus-BREILING-STECK

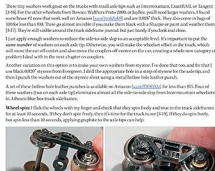

Wheelset This is where you'll find all the information you need to know about wheels and tires. It covers everything from the basic types of wheels to the more advanced types like the ones used on the new locomotives. It also includes information on how to choose the right wheels for your train and how to maintain them.

Page 13 Chapter 3 Wheelset/trucks

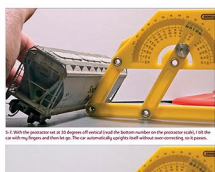

Wheelset This is where you'll find all the information you need to know about wheels and tires. It covers everything from the basic types of wheels to the more advanced types like the ones used on the new locomotives. It also includes information on how to choose the right wheels for your train and how to maintain them.

Page 17 Chapter 3 The car body

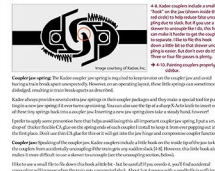

Wheelset This is where you'll find all the information you need to know about wheels and tires. It covers everything from the basic types of wheels to the more advanced types like the ones used on the new locomotives. It also includes information on how to choose the right wheels for your train and how to maintain them.

Page 11 Mini-Franklin-Bus-BREILING-STECK



Wheelset This is where you'll find all the information you need to know about wheels and tires. It covers everything from the basic types of wheels to the more advanced types like the ones used on the new locomotives. It also includes information on how to choose the right wheels for your train and how to maintain them.

Page 16 Mini-Franklin-Bus-BREILING-STECK

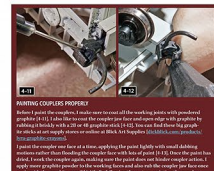

Wheelset This is where you'll find all the information you need to know about wheels and tires. It covers everything from the basic types of wheels to the more advanced types like the ones used on the new locomotives. It also includes information on how to choose the right wheels for your train and how to maintain them.

Page 15 Chapter 3 Couplers

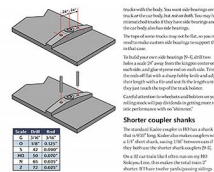

























































Wheelset This is where you'll find all the information you need to know about wheels and tires. It covers everything from the basic types of wheels to the more advanced types like the ones used on the new locomotives. It also includes information on how to choose the right wheels for your train and how to maintain them.

Page 10 Chapter 3 The rolling stock considerations



Inspirational LAYOUT TOURS!

 2018-06-3: Devin Heimbach's Santa Fe 02-01 - Jun 2018 ACT 10 - Orem Heimbach's Santa Fe 2018 (2018)	 2018-05-4: Roger Chrysler's Lake Erie & Northern 05-19 - Apr 2018 ACT 10 - Orem Chrysler's Lake Erie & Northern 2018	 2018-04-3: Steve Peters' Santa Fe 03-19 - Apr 2018 ACT 10 - Orem Peters' Santa Fe (2018) (2018)	 2018-03-3: Don Ball's Jacksonville & Cooperstown 03-19 - Mar 2018 ACT 10 - Orem Ball's Jacksonville & Cooperstown (2018)	 2015-01-3: David Jacob's Silverdale & Western 01-16 - January 2015 ACT 10 - Orem Jacob's Silverdale & Western (2015)	 2014-12-1: The Aberystwyth Junction 12-16 - November 2014 ACT 10 - Orem The Aberystwyth Junction (2014)	 2014-11-3: Virginia Southwestern Road Lanes E16 10-16 - November 2014 ACT 10 - Orem Southern Road Lanes (2014)	 Frio Ridge RR - a Gorra & Caputo Book series 10-16 - Nov 2014 ACT 10 - Orem Frio Ridge RR (2014)
 2018-06-3: Rick Heimbach's Frio 11-16 - Jun 2018 ACT 10 - Orem Heimbach's Frio (2018) (2018)	 2018-01-3: Eric Goodman's Santa Fe Express Sub 01-16 - Jan 2018 ACT 10 - Orem Goodman's Santa Fe (2018)	 2017-11-3: Bill Cobles Rio Grande Southern, pt. 2 10-16 - Oct 2017 ACT 10 - Orem Cobles Rio Grande Southern (pt. 2) (2017)	 2017-11-4: Bill Cobles Rio Grande Southern, pt. 1 10-16 - Nov 2017 ACT 10 - Orem Cobles Rio Grande Southern (pt. 1) (2017)	 2014-10-1: Quaker & New England RR ops 10-16 - October 2014 ACT 10 - Orem New England RR (2014)	 2014-09-3: Dick Joyce's Hagerston & Gauley 09-16 - September 2014 ACT 10 - Orem Joyce's Hagerston & Gauley (2014)	 2014-08-1: John Miller's Kananaskis and Lake Erie 08-16 - September 2014 ACT 10 - Orem Miller's Kananaskis and Lake Erie (2014)	 2014-08-4: L'Espresso at the 2014 National Train Show 08-16 - August 2014 ACT 10 - Orem L'Espresso at the 2014 National Train Show (2014)
 2017-04-3: Our Home and Miniature Land 04-16 - Apr 2017 ACT 10 - Orem Our Home and Miniature Land (2017)	 2016-11-4: DuWayne Eschaly's Chesapeake & Ohio 11-16 - November 2016 ACT 10 - Orem Eschaly's Chesapeake & Ohio (2016)	 2016-11-3: Mike Peters' Ken Valley Railway 11-16 - Nov 2016 ACT 10 - Orem Peters' Ken Valley Railway (2016)	 2016-11-2: The narrow gauge niche 11-16 - Nov 2016 ACT 10 - Orem Narrow gauge niche (2016)	 2014-07-1: Jerry Fashenko's Perry/Rising 07-16 - July 2014 ACT 10 - Orem Fashenko's Perry/Rising (2014)	 2014-06-2: Steel industry modeling - New York Airco 06-16 - June 2014 ACT 10 - Orem Steel industry modeling (2014)	 2014-06-1: Mitch Braucher's Delaware & Hudson 06-16 - Jun 2014 ACT 10 - Orem Braucher's Delaware & Hudson (2014)	 2014-05-2: Bill Duff's Forest Park Southern 05-16 - May 2014 ACT 10 - Orem Duff's Forest Park Southern (2014)
 2016-08-2: Wally Bray's Canadian National 08-16 - Aug 2016 ACT 10 - Orem Bray's Canadian National (2016)	 2016-07-1: Naptown & White River Club 07-16 - Jul 2016 ACT 10 - Orem Naptown & White River Club (2016)	 2016-06-2: Bob Case's B&O West End 06-16 - June 2016 ACT 10 - Orem Case's B&O West End (2016)	 2016-05-3: Rick Norris' Rio Grande Southern 05-16 - May 2016 ACT 10 - Orem Norris' Rio Grande Southern (2016)	 2014-04-4: Sundance Central RR Roundup 04-16 - Apr 2014 ACT 10 - Orem Sundance Central RR Roundup (2014)	 2014-04-2: What ever happened to The Nebelway 04-16 - Apr 2014 ACT 10 - Orem The Nebelway (2014)	 Hot Trains - Alco Menia 04-16 - Apr 2014 ACT 10 - Orem Alco Menia (2014)	 2013-08-4: Barry's Backyard 08-16 - Aug 2013 ACT 10 - Orem Barry's Backyard (2013)
 2016-04-3: Ericson Marquette's River 04-16 - Apr 2016 ACT 10 - Orem Marquette's River (2016) (2016)	 2016-03-3: Dave Pretry's Marquette Central 03-16 - Mar 2016 ACT 10 - Orem Pretry's Marquette Central (2016)	 2015-10-6: Season 3 layout tour 10-16 - Oct 2015 ACT 10 - Orem Season 3 layout tour (2015)	 2015-10-4: George Selton's B&O Update 10-16 - Oct 2015 ACT 10 - Orem Selton's B&O Update (2015)	 2014-03-1: Wattertown club and Lake Erie layout 03-16 - Mar 2014 ACT 10 - Orem Wattertown club and Lake Erie layout (2014)	 2014-03-2: End of the Line 03-16 - Mar 2014 ACT 10 - Orem End of the Line (2014)	 The Allgash story - Mike O'Connell's layout 03-16 - Mar 2014 ACT 10 - Orem Allgash story (2014)	 2014-03-1: Bob Bartlett's O&A 03-16 - Mar 2014 ACT 10 - Orem Bartlett's O&A (2014)
 2015-06-5: Loop Lake Railway Running Storage 06-16 - Jun 2015 ACT 10 - Orem Loop Lake Railway Running Storage (2015)	 2015-05-1: Pete Smith's Loop Lake Railway 05-16 - May 2015 ACT 10 - Orem Smith's Loop Lake Railway (2015)	 2015-05-1: Lewis County model railroad club 05-16 - May 2015 ACT 10 - Orem Lewis County model railroad club (2015)	 2015-06-1: Shaun Tomney's UP Oregon Division 06-16 - Jun 2015 ACT 10 - Orem Tomney's UP Oregon Division (2015)	 2014-01-4: Barry Bartlett's G Scale Garden RR 01-16 - Jan 2014 ACT 10 - Orem Bartlett's G Scale Garden RR (2014)	 2014-01-1: Jim Solloway's Union Pacific layout 01-16 - Jan 2014 ACT 10 - Orem Solloway's Union Pacific layout (2014)	 2013-12-1: Lex Parker's O&D D&RW part 1 12-16 - Dec 2013 ACT 10 - Orem Parker's O&D D&RW part 1 (2013)	 2013-12-1: Lex Parker's O&D D&RW part 2 12-16 - Dec 2013 ACT 10 - Orem Parker's O&D D&RW part 2 (2013)
 2015-05-4: Jeff Sergeant's Owl & Fox layout 05-16 - May 2015 ACT 10 - Orem Sergeant's Owl & Fox (2015)	 2015-03-3: Chelsea Branch Open House 03-16 - Mar 2015 ACT 10 - Orem Chelsea Branch Open House (2015)	 2015-03-1: Columbia Gorge Club 03-16 - Mar 2015 ACT 10 - Orem Columbia Gorge Club (2015)	 2015-02-1: Mike Porter's Chicago Great Western 02-16 - Feb 2015 ACT 10 - Orem Porter's Chicago Great Western (2015)	 2013-11-2: Tom Patterson's O&A 11-16 - Nov 2013 ACT 10 - Orem Patterson's O&A (2013)	 2013-11-1: Tim Warren's Bronx Terminal 11-16 - Nov 2013 ACT 10 - Orem Warren's Bronx Terminal (2013)	 1.7 Bonus footage - Full train 11-16 - Nov 2013 ACT 10 - Orem Bonus footage (2013)	 1.8 Skellys Line - Upper Rock Tour 11-16 - Nov 2013 ACT 10 - Orem Skellys Line - Upper Rock Tour (2013)



TrainMasters TV

A lifetime of hobby insight at your fingertips

Summer special pricing in effect!

Check it out!

www.trainmasters.tv

YES ... IT'S A MODEL



Model Railroad Hobbyist | July 2018 | #101

compiled by **JOE FUGATE**



1. This is the new stone arch bridge on the On30 Ruphe and Tumbelle Rwy. Co. of Rick Reimer. It spans an, as yet unnamed, unfinished creek area. The bridge is scratchbuilt using extruded foam cut in Rick's laser cutter and then fit into the existing scene. The cars are, left-to-right, from AMS, Bachmann and a scratchbuilt combine. The natural rockwork is foam as well, all hand-carved.

► **MRH'S MONTHLY PHOTO ALBUM**

• [INDEX](#)



SUBSCRIBE
(free)

• [TABLE OF CONTENTS](#)



2. Another bright yellow tank car rolls on by in the blazing sun. The local rolls south of the faux town of Longview along the rolling farm lands of the Front Range in Colorado on the Longmont Terminal & Northern Model Railroad with Rio Grande #1182 class C48 2-8-0 on the point. Every day the local delivers



merchandise, heating oil, gasoline, and heavy industrial products to the small communities along the Branch Line. The scene is on a sectional layout that Erik Lindgren and his friend set up at local venues two or three times per year.





GET PAID FOR YOUR PHOTO

We pay **\$40 per photo** we publish. If you'd like to get your modeling in our photo feature, just start posting your photos on the *MRH* website, especially in the Weekly Photo Fun thread created each week.

See mrhmag.com/help for more on how to post an image. You need to be an *MRH* subscriber to post photos to our website, and becoming a subscriber is free, [just fill out this form here](#). ■



RATE THIS ARTICLE

Do ALL your model railroading friends know about MRH?

WE CONTINUE TO BE SURPRISED BY HOW MANY MODELERS STILL HAVE NEVER HEARD OF US - SO SPREAD THE GOOD WORD ABOUT MRH!

NORTH AMERICAN RAILCAR CORPORATION



Pullman Standard 5077cf 50' Single Door Boxcars



Accuracy and Detail... in Scale



Look for these Railways in our first production of 16 Roads

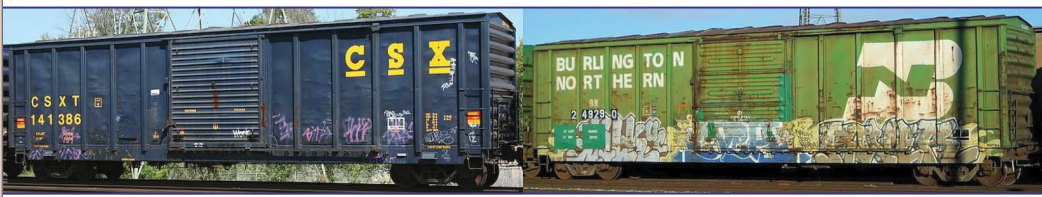

CLICK HERE FOR
HO-5077 Boxcar

Coming Soon!!!

CLICK HERE FOR
N-5077 Boxcar

NARC Cars are sold exclusively through

Pacific Western Rail Systems

• [INDEX](#)



SUBSCRIBE
(free)

• [TABLE OF CONTENTS](#)



A Farmhouse for Goff Brook

Model Railroad Hobbyist | July 2018 | #101

CHRIS ADAMS uses prototype inspiration to elevate an ordinary kit into a structure with a backstory ...

I'M MODELING THE NEW HAVEN RAILROAD'S LINE between Hartford and Old Saybrook in Connecticut during the autumn of 1948. One of the scenes along the way, just over the line from Wethersfield in the town of Rocky Hill, is a bridge over Goff Brook.

• [INDEX](#)

• [TABLE OF CONTENTS](#)



RATE THIS ARTICLE

My friend John Wallace railfanned this area during the late '40s and has been a priceless resource of photos and information in recreating this line. But this dynamic hasn't been without its drawbacks. Case in point – the following conversation about the Goff Brook scene, which was “finished” at this point:

John: “You know, there was a farmhouse there by the side of the road.”

Me: “I don't think it was there in the late '40s – besides, I really don't have a lot of room there.”

John: “That's too bad, because there was a little dog at that house that always ran out and chased the Valley Local down the tracks – and the house is still there today, by the way.”

That sent me back to my photo files. And of course, he was right. The house was there, right smack dab in the middle of my era. It's shocking how often we miss what's right in front of us.

But, I thought “*no way is that house there today – I would have remembered.*” So, the next morning on my way to work, I drove by the site.

**VIEW READER
COMMENTS**

click here



A FARMHOUSE FOR GOFF BROOK | 3



1. The Valley Local southbound at Goff Brook, June 1948. That's the back of the farmhouse in the left back-ground. *Kent Cochrane photo, NHRHTA collection, used with permission*



2. Sure enough, John was right. It's still there, virtually unchanged from 70 years ago. And it looked awfully familiar ...



3. The City Classics “Railroad Street Company House Kit” is just about a perfect match for the prototype. Best of all, I don’t have to scratchbuild!

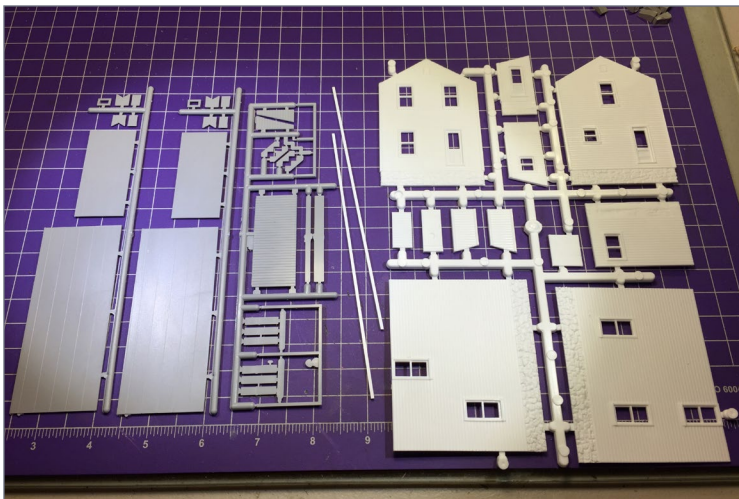

4. After familiarizing myself with all the parts that come with the kit, I divided the parts up into piles for different colors of paint and used a distressing brush to add some additional grain to the stairs, porch, and outhouse. This house will be well-kept, so the walls will remain in good shape.



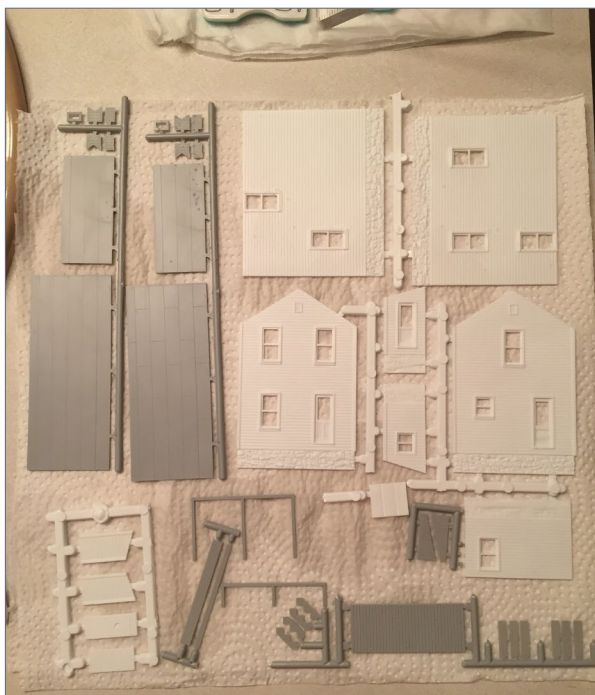

5. A stiff toothbrush with soap and warm water removed any oils that would hinder paint adhesion, and knock off any fuzz left from the distressing brush, then I left the parts on paper towels to dry overnight.



6. I used just two main colors -- a flat gray for the roof sections, porch and porch floor supports, and stairs; and a flat white for all the walls and porch roof supports. I figured I'd hand-paint the chimney with a brush since I'd have to do that with the molded-in stone foundation as well.

A FARMHOUSE FOR GOFF BROOK | 6

There are two types of foundations on this kit, molded right along with the bottom of the walls: stone under the main house, and concrete under the lean-to addition.



7. Here are the pieces painted and ready for assembly. Once the two main colors dried, it was time for detail painting. My prototype photo, thankfully, shows the window frames and the trim as white, just like the walls. All I had to do was paint the chimney and foundations.





8. I use mostly \$.50/bottle acrylic craft paints – granite gray, pewter gray, barn red, and black with “Concrete” from Woodland Scenics and an alcohol and India ink mix as an overall wash.

Please tell your buddies about MRH!

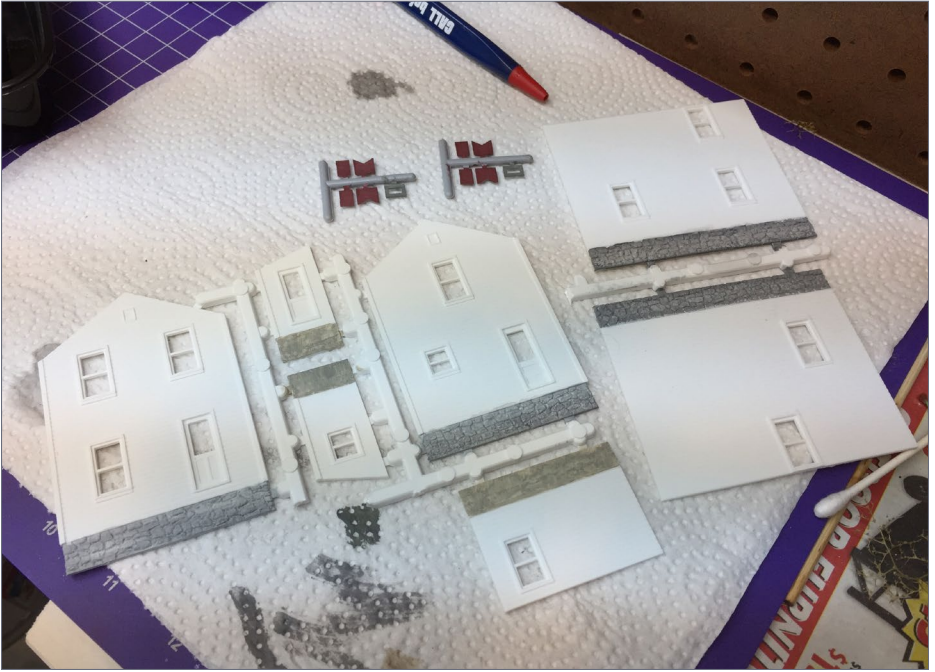

9. I start by using the concrete paint on the concrete foundation, and the granite gray on the stone foundation. Both were too light, so I darkened them with the India ink wash. Be sure to mask the bottom edge of the walls to get a nice clean line between the walls and foundation. The chimney was easy – two coats of barn red with a pewter gray cap.

**VIEW READER
COMMENTS**

click here



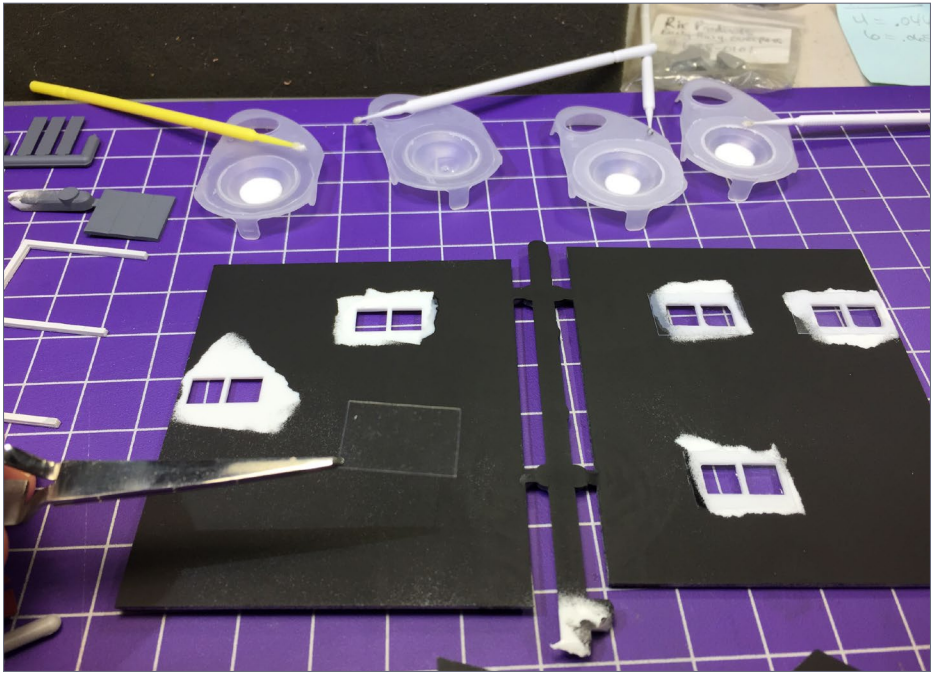

10. Next, I added the window glass and some curtains from an old kit. After some experimentation with different adhesives (seen in the little cups above), I decided on Aleene's Clear Gel Tacky Glue applied with a Microbrush or toothpick. It's great for adding windows and curtains – it grabs quick,

gives you time for positioning, and goes on and dries crystal clear.

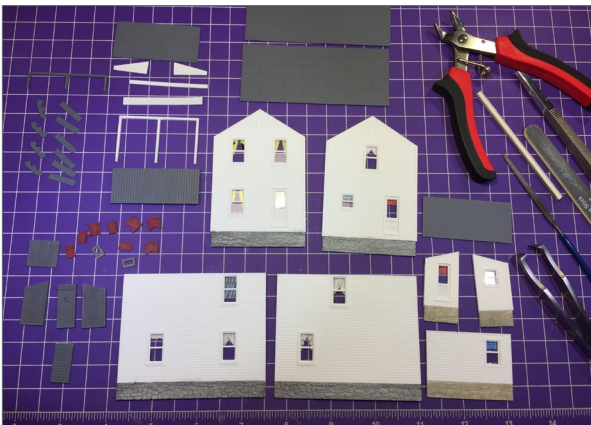

11. After all this preparation, it was time for assembly.

A FARMHOUSE FOR GOFF BROOK | 10

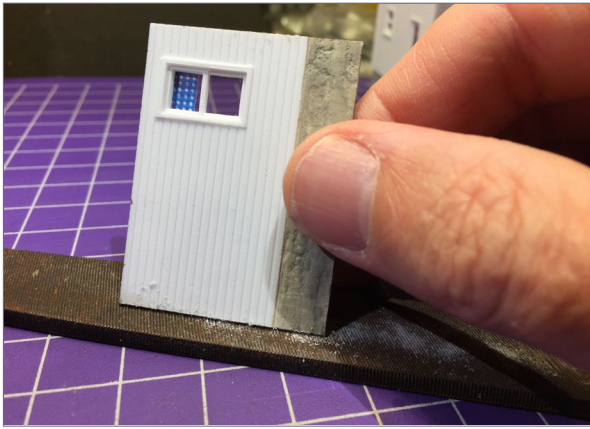

12. I used a mill file to make all the wall mating surfaces perfectly straight and flat, with a very slight angle to guarantee that the clapboards would mate tightly at the corners.



13. For bracing, the instructions call for adding a piece of the supplied strip styrene "1/16-inch from the edge of the wall and parallel to it." Turns out, the strip styrene they supply is 1/16" thick, so I positioned two pieces side by side

on the wall, and put the wall perpendicular to a piece of plate glass. That way I made sure that if the spacer was flush with the edge of the wall, the glued piece would be perfectly parallel to, and the right distance from, the edge. I tacked the brace in place, then removed the spacer piece and applied more cement around the rest of the brace.



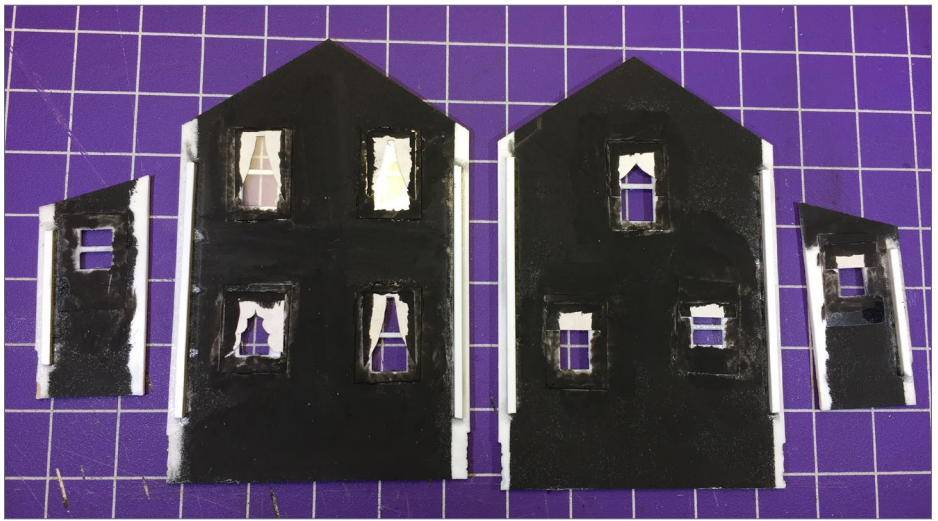

14. Repeat the process for the other side of the end wall, both sides of the opposite end wall, and the side walls of the addition.

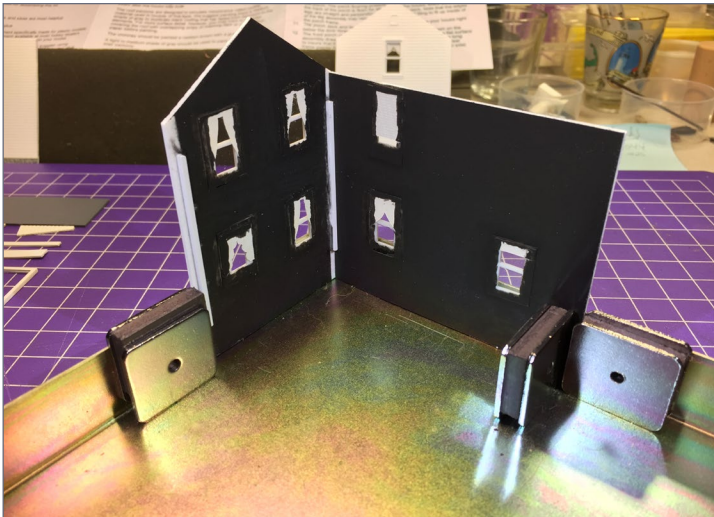

15. Next, I used a very handy magnetic gluing jig to true up the walls to a 90-degree angle and hold them in place while I applied cement to the joint.

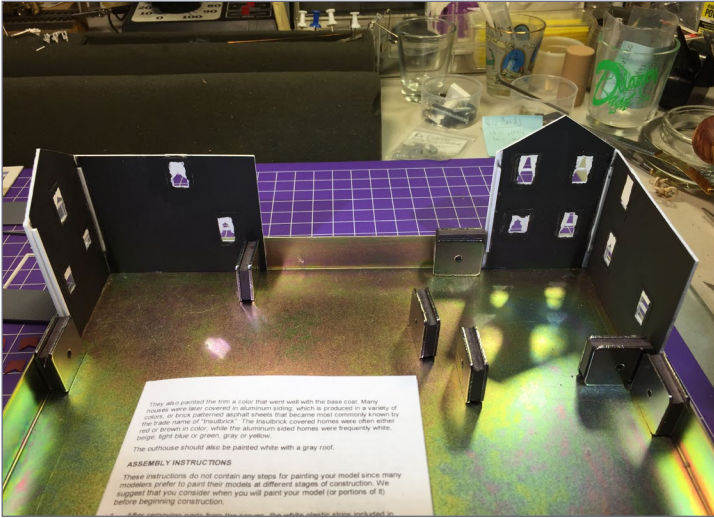

16. Do one corner at a time, repeating the process for the other corner.

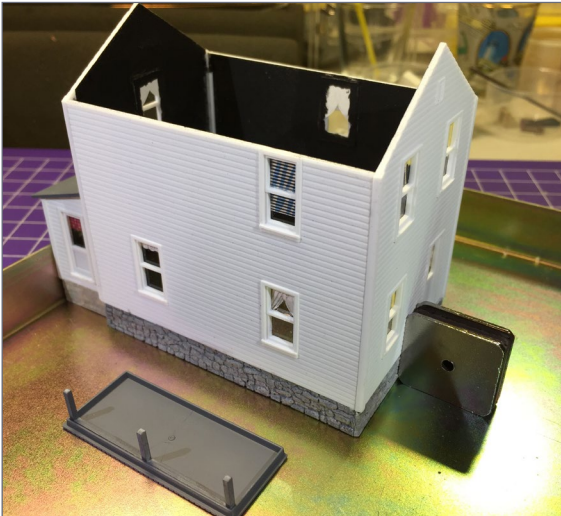

17. After gluing the two main “Ls” of the walls together, I glued the two sides of the addition to the addition’s back wall, let that dry, then attached the addition assembly to the back of the main house, using one of the magnets to press the house and the addition together. I also added the roof on the addition, making sure that the angled edge pressed tight against the back wall of the main house.



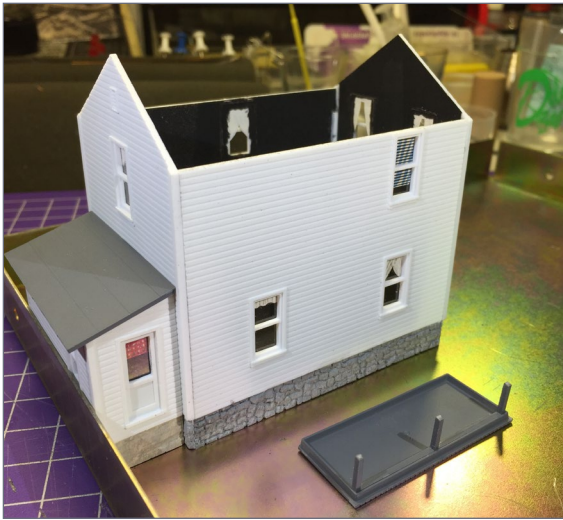

18. At this point, I glued the porch support legs to the porch deck. Two things to note here: 1) you will likely need to file/sand the left and right ends of the leg assembly a bit to get it to fit into the porch deck frame; and 2) make sure that the legs attach

to the *front* of the porch deck – the edge that has the flooring overhanging slightly.



19. While all that was drying, I remembered to make sure that the inside of the chimney was black. I often find that the easiest way to “paint” small black areas right at the bench is to use a black Sharpie.

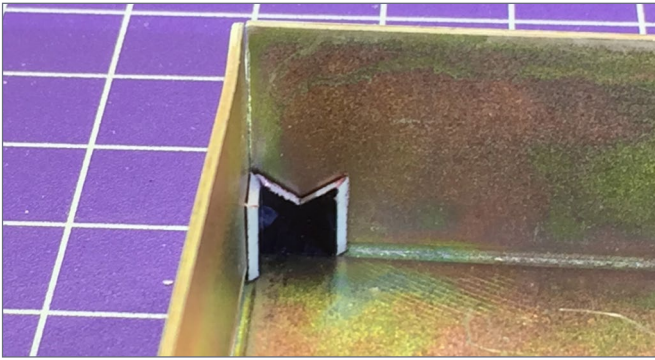

20. The chimney parts are so small no bracing is needed and the edges are already milled at 45 degree angles for assembly. Be sure the sides are glued at true right angles. Again, the gluing jig makes this easy.

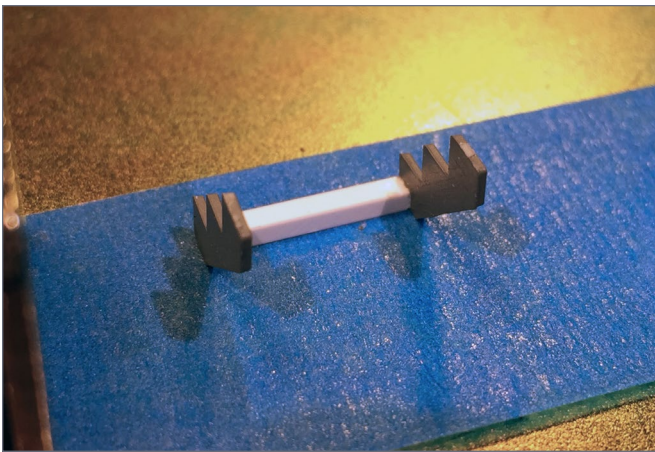

21. I next turned my attention to the two stair assemblies. The stringers are supposed to be 1/2" apart and the instructions mention gluing a 1/2" long piece of the leftover 1/16" strip to the house and then adding the steps to it. I thought I'd be clever and glue the 1/2" piece to the stringers first as a spacer and *then* glue the whole assembly to the house at once. To hold everything in place for gluing, I used a piece of blue masking tape sticky side up, as shown.



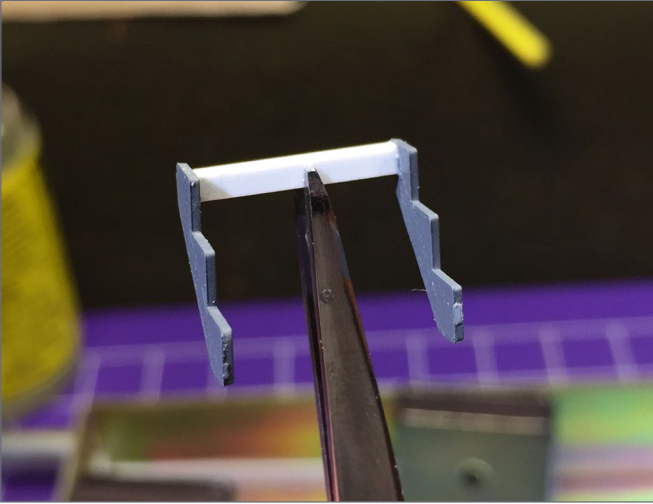

22. If you assemble your steps this way, be *certain* the spacer is flush along the backs of the stringers as well as along the tops of the stringers. You can see above that the left stringer is slightly higher.

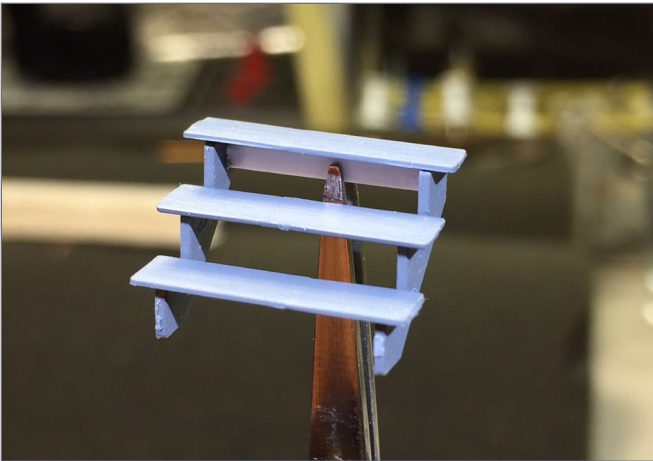

23. I pressed on with assembly, figuring I'd just make sure the top step was level and let the spacer (which would be hidden) stay at an angle. I used self-clamping tweezers to hold things while I used regular tweezers to apply the stair treads.



24. Here are the back steps, attached to the addition. My plan was easier in theory than execution. The top step is slightly angled, but as much of a pain as these steps were to put together, I decided I could live with that.

Next time, I think I'll follow the instructions.

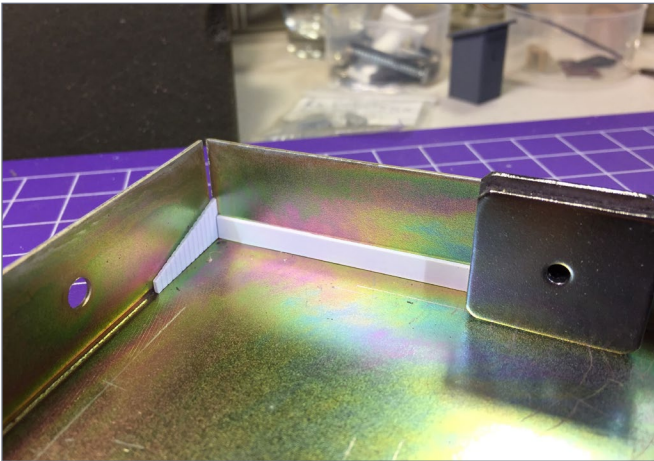

25. The porch roof frame was next. In the future, I may add little bits of square strip to the inside corners to strengthen these joints.



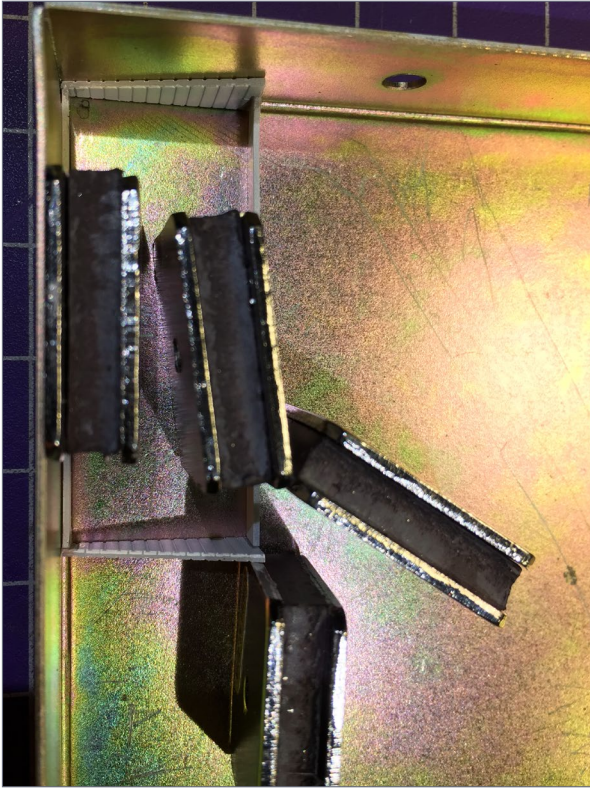

26. You can see I rely pretty heavily on this magnetic gluing jig. No less than four magnets hold everything square in the corner for gluing. Like the main walls of the house, I first glued two pieces together, making two 2-piece assemblies (2 "L"s) before I glued the 2 "L"s together.

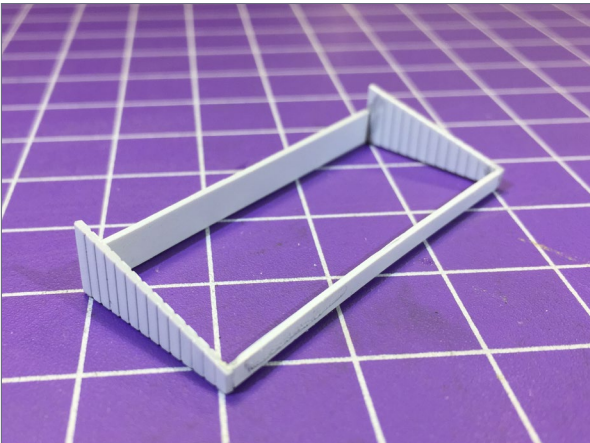

27. As always, don't forget to remove any paint from gluing surfaces. This is especially critical here where the mating surfaces are so tiny. Be certain that the four pieces are flush on the bottom or your porch roof will be slightly off.

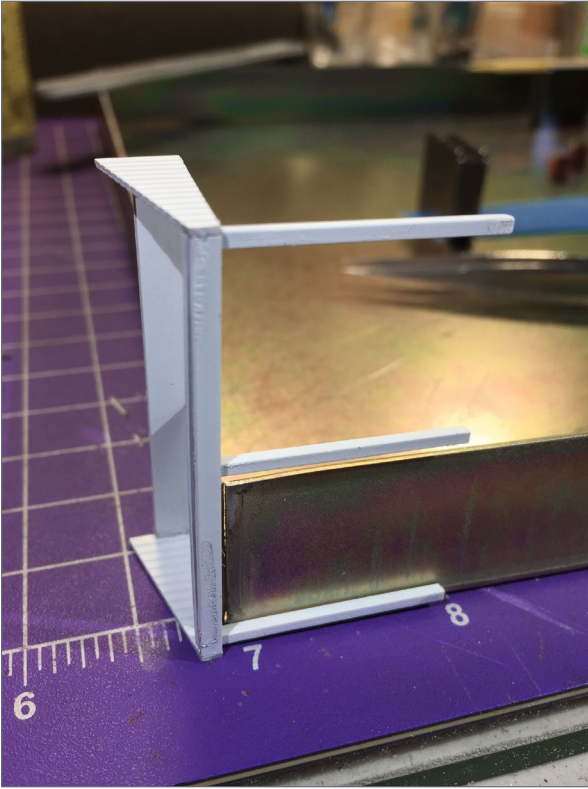

28. I next added the roof support legs to the roof support frame. Be sure not to force the legs at all when you insert them between the roof frame sides. File/sand to fit as needed, or else risk forcing the frame apart. It's also important that the supports be at a right angle to the frame, as shown.

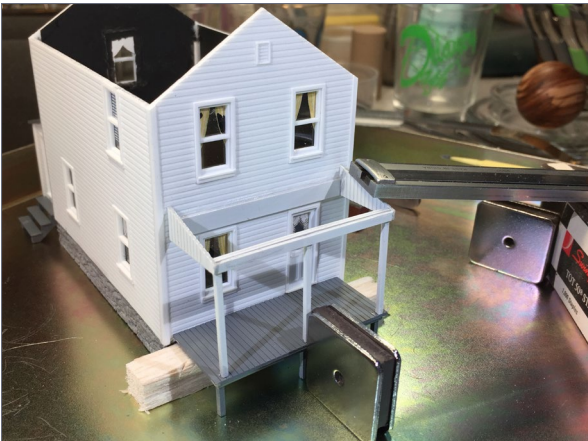

29. Once that all dried, I added the porch to the house, as well as the porch roof support assembly. A scrap piece of balsa supports the back edge of the porch for gluing and I used a magnet to press the porch against the house.

Adding the porch roof support was a bit tricky. You want to be certain the sides are square to the porch and that the frame is level from side to side. Lining up with the clapboards helps, and those same clapboards will make it obvious if your porch roof isn't perfectly level.



30. I added the porch roof as I had the roof on the addition, making sure the beveled edge was snug against the wall. I glued the two halves of the main roof together first, approximating the correct angle, and once the glue was almost cured, but not completely set, I added glue on top of the side and end walls. The angle of the roof was slightly off and did not match the gable peaks exactly, so I used a bag of ballast formed to weigh the roof down against the tops of the walls while the glue cured.

With that, the basic house was finished except for the chimney. I thought adding some stacks and vents and an electrical service would look more authentic.

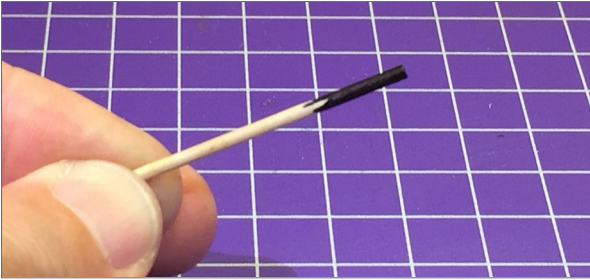

in scale, "painted" with my black Sharpie.

31. Typically, you can make a stack/vent from styrene rod. I didn't have any, so I improvised with a toothpick which is approximately 4" diameter

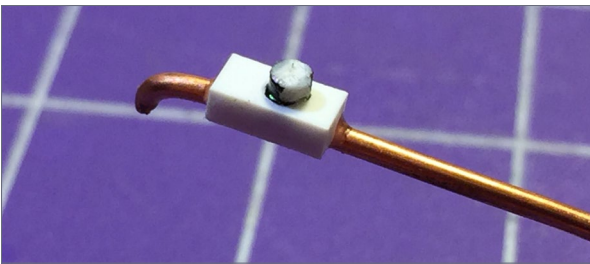

32. The electrical service was a bit more involved. There are commercial parts available and I may use those for future projects, but I didn't want to wait. Then

it occurred to me that I could just go outside and measure the parts of my electrical service. The meter box is 8.5" wide, 14" tall, and 4.5" deep. The clear glass dial is about 5.5" in diameter. Here's what I came up with:

- Service box: a piece of .060x.188" styrene strip, cut to 4.5" wide
- Dial: .060" dia. styrene rod out of my scrap box
- Conduit: 20 gauge solid copper wire with the insulation stripped off

I applied a drop of Testors Model Master Liquid Cement to the box and added the dial.

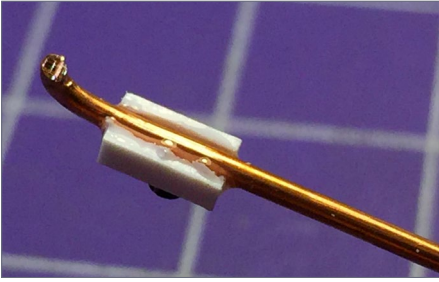

33. I next routed out the back with an .060" drill bit in my Dremel, being careful not to break through the front. A foot/speed pedal really helps here. I bent the wire and clipped it so that most of the curve was gone and it would fit into the wall more easily. Then I used thin CA to fasten the box to the wire.



34. I sprayed the conduit/ meter assembly with gray primer and while that was drying, I located and drilled holes for the bathroom stacks/vents, guessing where they'd be in the house. Then I glued the chimney on with plastic cement and press-fit the toothpick stacks in the holes, securing them with thin CA.



35. Once the electrical conduit was dry, I marked how tall it should be, and bent/snipped the wire at that point for a weather head. Then I pressed the bottom of the conduit in a hole I drilled in the wall and, making sure it was perfectly vertical – a small bit of styrene offsets the conduit from the wall – and secured it with thin CA.

LIST OF MATERIALS

- City Classics “Railroad Street Company House Kit” #111 (1 kit) or #112 (3 kits) (www.cityclassics.biz/c_house.html)
- Aleene’s Clear Gel Tacky Glue (www.aleenes.com/aleenes-always-ready-clear-gel-tacky-glue)
- Testors Model Master Liquid Cement #8872C (www.testors.com/product-catalog/testors-brands/model-master/adhesives/adhesives)
- Thin CA
- Spray paint
 - Gray Primer, Flat White, Flat Black
- Apple Barrel acrylic craft paints (plaidonline.com/brands/apple-barrel-craft-paint)
 - Granite Gray #21392, Pewter Gray #20580
 - Barn Red #20577, Black #20504
- Woodland Scenics “Concrete” acrylic paint #ST1454 (woodlandscenics.woodlandscenics.com/show/Item/ST1454/page/1)
- Alcohol/India ink mix
- Black Sharpie (www.sharpie.com/sharpie/fine/SHFineBlack-Fine.html#start=1)
- Hunterline Light Gray Weathering Mix (hunterline.com/products/copy-of-creosote-black)
- PanPastels (panpastel.com)
 - Black #800.5, Neutral Gray #820.5, Raw Umber #780.5 ■



ELECTRICAL SERVICE MISTAKE – AND HOW I FIXED IT



S1. An electric service weather head popping through the roof is correct in some situations – but not in the case of this farmhouse. And there’s a photo that shows it is wrong.

A little prototype research can be a dangerous thing. During my research of how to model an electric service, I found a diagram showing it going through the roof – as you see in the photo above. Unfortunately, I should have just consulted my prototype photo again – it clearly shows the weather head below the roof. Apparently, conduits only go above the roof when it’s necessary to get the weather head at least 10 feet above ground.

So, after lots of vacillation and trying to convince myself nobody would notice, I decided to go ahead and fix it. Here are the steps I took, in case you ever find yourself in a similar situation which – hopefully now that you have the benefit of my experience here – you won’t.

- Carefully pry the conduit out of the side of the wall. Cushioned tweezers will prevent chipping the paint.

- Clip off the “weather head,” the old bent end of the wire, pull the conduit through the hole, and set it aside.
- Fill hole with Squadron Green Putty or styrene rod.
- Sand lightly when dry to make the patch flush with roof. Apply another coat of putty and sand.
- Decant the same color spray paint used for the roof into an old bottle cap and use a Microbrush to replace the paint in this area and cover everything up.
- Cut the conduit to a shorter length (based on the prototype photo!) and bend a new weather head.
- Add a styrene 2x4x12 to the wall for mounting the weather head end of the conduit.
- Replace conduit, gluing in place with CA.
- Realize that the repaint you did looks a little rough and takes the light differently.
- Decide to respray the roof.

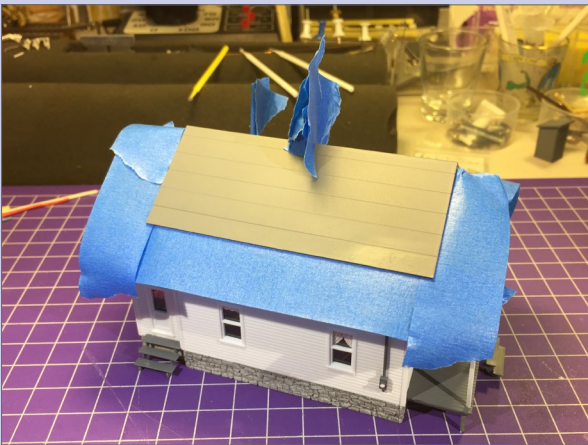

S2. You can see glare and discoloration where the hole was. Apply tape to the underside of the roof, sticky side up, and around the chimney.



ELECTRICAL SERVICE MISTAKE – AND HOW I FIXED IT CONTINUED ...

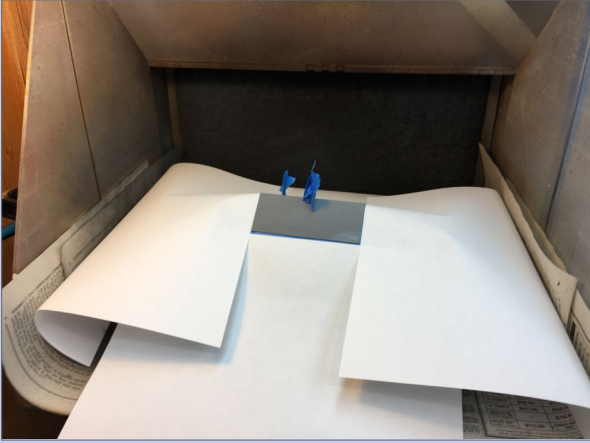

S3. Stick sheets of paper to the tape to protect everything else from paint and overspray.



S4. The patch might have been concealed with weathering, but respraying looks *much* better – and it's almost impossible to tell where the hole in the roof was. ■

I wanted to portray a decently-maintained rural house that happens to be right next to the railroad during the steam era. Prototype photos guided the effort but since my main photo was just taken recently, I used it primarily as a guide for weathering the roof. I weathered the rest of the house assuming that coal soot from home heating and passing locomotives would make the white paint a bit dingy, with some streaking from rainfall. I used a soft-bristled brush to streak a light gray wash vertically on the walls, holding the house *upside down* so that the wash would tend to collect a little under the edges of the clapboards, highlighting them. As with most weathering, you really need to be patient and not do too much at once. While you can wipe off some of the excess, it's much better to build up the effect *gradually*. The key is to know when even "just a little bit more" would be too much. And that sixth sense only comes with practice. So, I practiced on the side of the house that will face the backdrop and worked my way around to the other, more visible sides. I also used the wash around the stone foundation to make it "pop" a bit more.

When talking
to hobby
vendors,
please
remember to
mention MRH.

**VIEW READER
COMMENTS**

click here





36. I applied some PanPastels as well, especially on the roof. The three main colors I used were Black, Neutral Gray, and Raw UMBER. The black went on pretty heavily as soot around the top of the chimney, and as mold and soot streaks down the roof and walls. I used the gray to “sun beat” (lighten) the roofs a bit, add some contrast, and also lighten any black that was too black. The raw umber was used sparingly here and there for some additional contrast and mud splatters. I also used it with the gray to weather the “wood” porch floor.





37. Here's the finished product – a suitably sooty but well-maintained farmhouse, viewed from the left front.



38. Right front view of the finished farmhouse.



39. Right rear view of the finished farmhouse.





40. Low angle left front view of the finished farmhouse.
Bill Schneider photo



41. Here is the farmhouse temporarily in place on the layout.

I still have a bit more I want to do here: plant the house, add a walkway, mailbox, power lines, garage. And I have to find a local kid to “mow” the lawn.

I’m very pleased with how this off-the-shelf kit, with just a little extra work, does such a great job helping to recreate what’s becoming a signature scene on the layout. I need to add an HO scale dog running along the tracks but first I’ll have to ask John what breed it was – you know, for prototype accuracy.

**VIEW READER
COMMENTS**

click here

**Use our custom
Google search on the
MRH website to find
topics of interest**

CLICK TO FIND OUT MORE





42. Another view of the farmhouse in place on the layout.



CHRIS ADAMS



Chris Adams has been into model railroading, off and on, for almost 35 years after having “borrowed” the train set his kid brother got one Christmas and got bored with later that day.

Chris is primarily into the historical research side of the hobby, using his layout to create a “time machine” back to the New Haven Railroad of the late 1940s. When he’s not in the basement, he enjoys bike racing, reading, and maintaining a website dedicated to railroading in the lower Connecticut River Valley at www.thevalleylocal.net.

He also volunteers as a photo archivist for the New Haven Railroad Historical & Technical Association (NHRHTA), works full-time as a legal counsel for the Connecticut General Assembly, and occasionally as a steam locomotive fireman and student engineer at the Valley Railroad in Essex, CT.

Chris lives with his wife, Debby, in Old Saybrook, CT, within earshot of the steam trains on the Valley Line. ■



n scale
click here



• [INDEX](#)



SUBSCRIBE
(free)

• [TABLE OF CONTENTS](#)



One Module Challenge First Prize winner

Model Railroad Hobbyist | July 2018 | #101

PETER VASSALLO designs a TOMA layout to move coal loads and empties across two railroads ...

MOST MODELERS ARE FAMILIAR WITH THE CONCEPT OF interchange, whereby cars are traded between railroads on connecting tracks. This is often accomplished on model railroads using sidings extending to the layout's edge to simulate connections "beyond" the layout. For those who favor operation, a



1. Chesapeake & Ohio on the left, and Clinchfield on the right – the two railroads on this layout plan.



single interchange track can provide more variety and volume of traffic than any other track.

Most interchange is implicitly modeled, involving manual transfer of cars to and from the interchange track. Elkhorn Yard explicitly models the transfer across railroads, with provision for both Clinchfield and C&O trains to enter and leave the yard.

In the real 1:1 world, Elkhorn Yard in Elkhorn City, KY, was the Clinchfield's northern terminus and the southern end of C&O's



ONE MODULE CHALLENGE | 3

Big Sandy subdivision [2]. All northbound traffic from the Clinchfield was transferred to the C&O at Elkhorn. Coal in hopper cars was the bulk of the traffic, with loads and empties moving both north and south along the two railroads.

The Moss mine complex, about 30 miles southwest of Elkhorn, provided a steady stream of coal well into the 1980s. These coal loads were destined for several power plants and mills, one example being Kentucky Power at the northern end of the line near Big Sandy Junction.

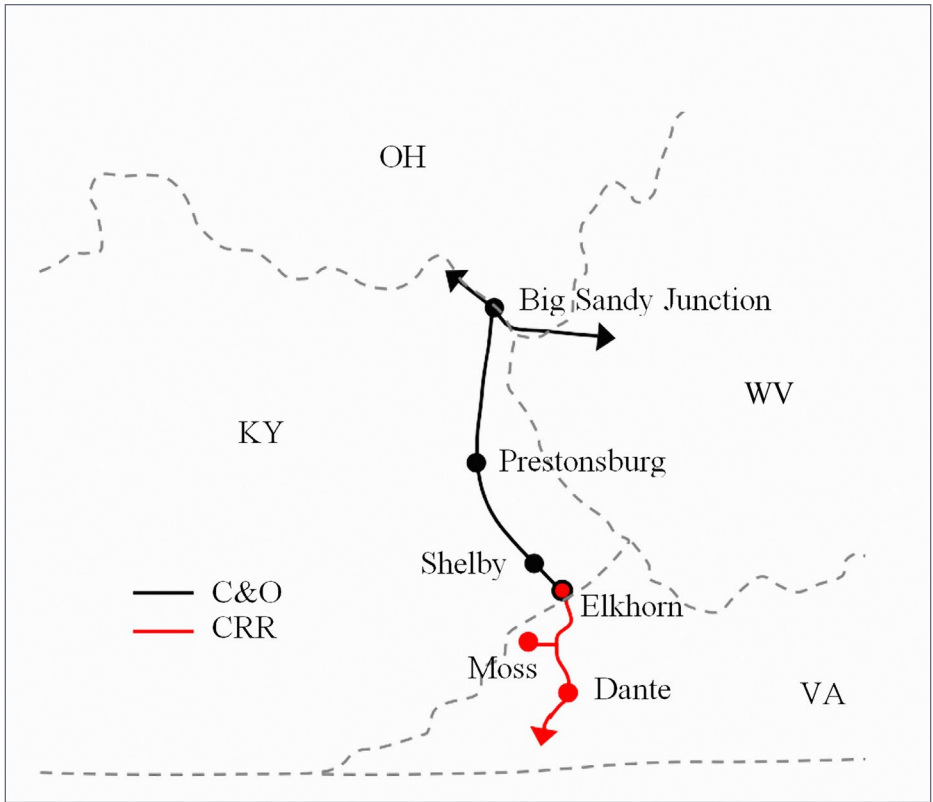

2. Simplified map of the Clinchfield and C&O routes from Elkhorn City, KY.

ONE MODULE CHALLENGE | 4

Beyond function, there are other features that make Elkhorn attractive to model. Because most cars were swapped expeditiously, an extensive array of yard tracks was not necessary, in contrast to nearby classification yards at Shelby, KY or Dante, VA. There were also numerous coal loaders within Elkhorn to provide some local switching.

These loaders accepted coal dumped from trucks. The coal was crushed and cleaned before being transferred to hoppers. Finally, the yard lay snugly between the banks of the Russell Fork River and the east Kentucky hills in a picturesque setting that helps frame the scene [3].



3. Picture of Elkhorn Yard, looking south from the C&O end of the yard. Numerous features to model are evident: weathered track and ballast/dirt mixture in yard, caboose track and spur for hoppers next to the coal loaders at left, shed in lower right corner, line poles and the Russell Fork river at right, and tree-covered hills. *David Wilson photo.*



Module designs

My Elkhorn module design is provided in [4]. I did not attempt to reproduce the yard precisely but wanted to capture the yard's basic function and character. I chose N scale because I think it is well suited to long unit trains and the switching of those trains.

When switching a coal mine, for example, I like to see the entire train in my field of view as the hopper cars are moved into place. Also, switching longer cuts reduces the need to frequently uncouple individual cars, lessening the chances of mechanical failure.

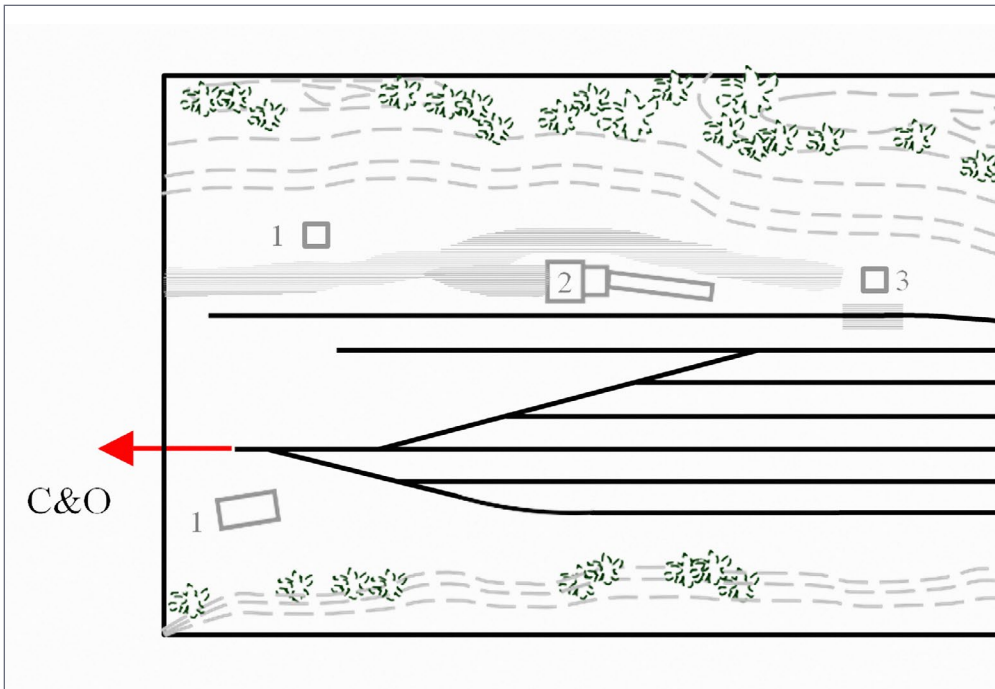

4. Elkhorn yard module, 2 x 6-feet, N scale. Structure key: (1) shed, (2) coal loader, (3) track scale, (4) office, and (5) fuel tank.

ONE MODULE CHALLENGE | 6

For this *TOMA with a Twist* contest, I chose to design two modules with continuous running between them. Since Elkhorn Yard provides a means of exchanging loaded and empty hopper trains, I thought it would be nice to have a companion module where loads and empties can also be exchanged, completing the cycle.

For the second module, I used the classic John Armstrong *loads-empties* exchange between a coal mine and power plant [5]. The mine and power plant are loosely based on Clinchfield's Moss mine and Kentucky Power on the C&O. The sidings in front of the module allow trains from either railroad to run around and

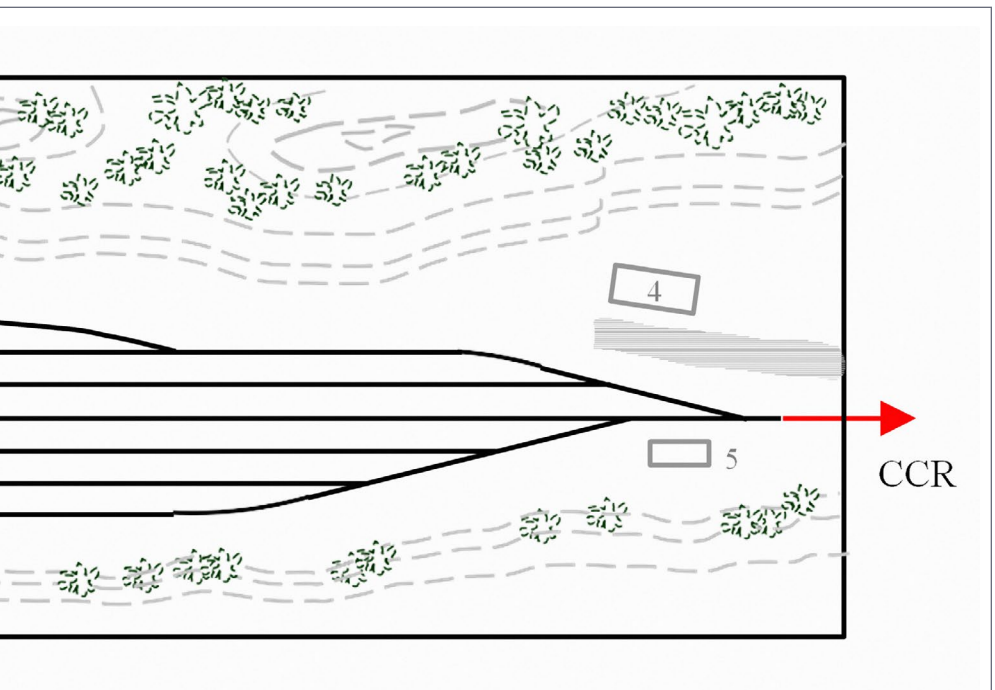

ONE MODULE CHALLENGE | 7

switch their respective industries. For example, an empty hopper train entering from the left represents a Clinchfield train entering the Moss mine facility.

After running around the train, the empties are pushed into the loading track underneath the mine, through the tunnel, and out the power plant on the right side. The loaded hopper cars — which were previously pushed into the power plant receiving track and out to the mine by a C&O train — are pulled and the Clinchfield train of loaded hopper cars is ready to depart.

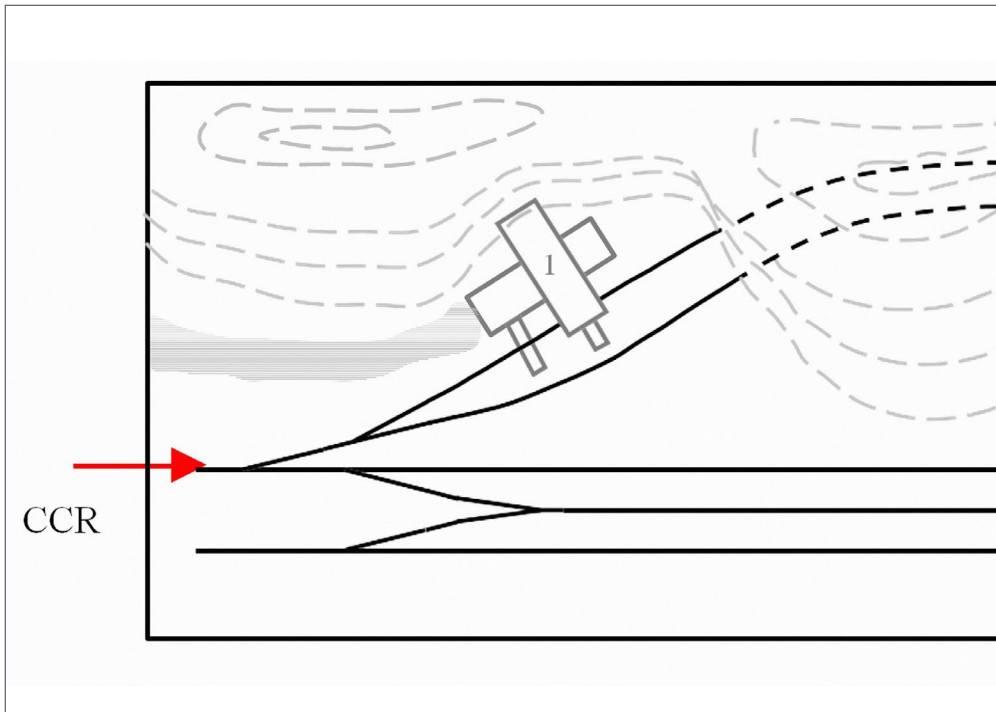

5. Mine module, 2 x 6-feet, N scale. Structure key: (1) coal mine, (2) power plant.

Did you know there's an MRH index available?

CLICK TO FIND OUT MORE

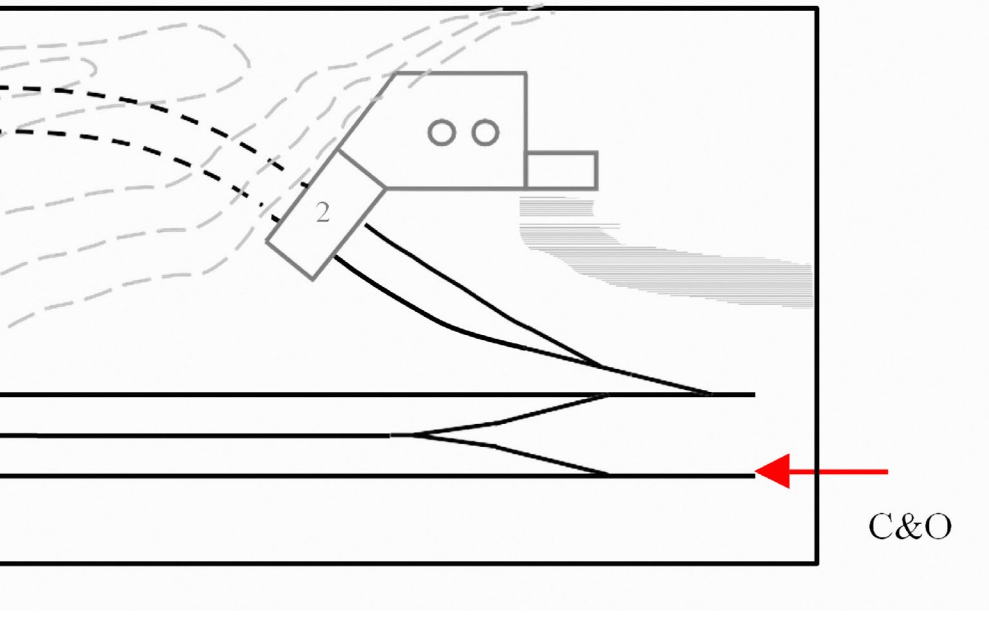

Stage 1 configuration

Initially, the two modules could be placed back to back, as described by Joe Fugate in the September 2017 issue of *Model Railroad Hobbyist*. A pair of 1 x 4-foot modules on either end would form a

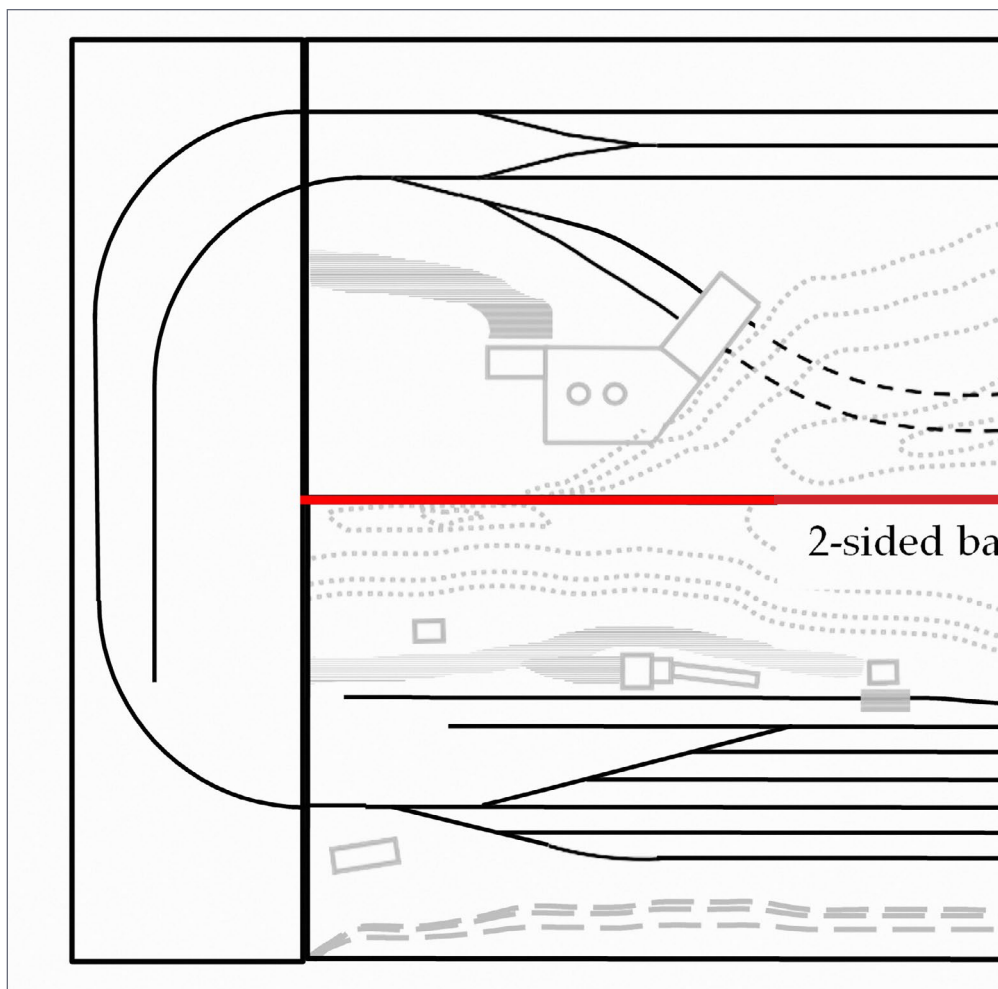

6. Island layout configuration, 4 x 8-foot overall size. The yard and mine modules are placed back to back and two end modules are added.

ONE MODULE CHALLENGE | 10

loop for continuous running [6-7]. This would be the quickest, most compact set-up for initial operations but it lacks mainline running distance and does not allow for staging between modules. However, this is an ideal set-up for display purposes.

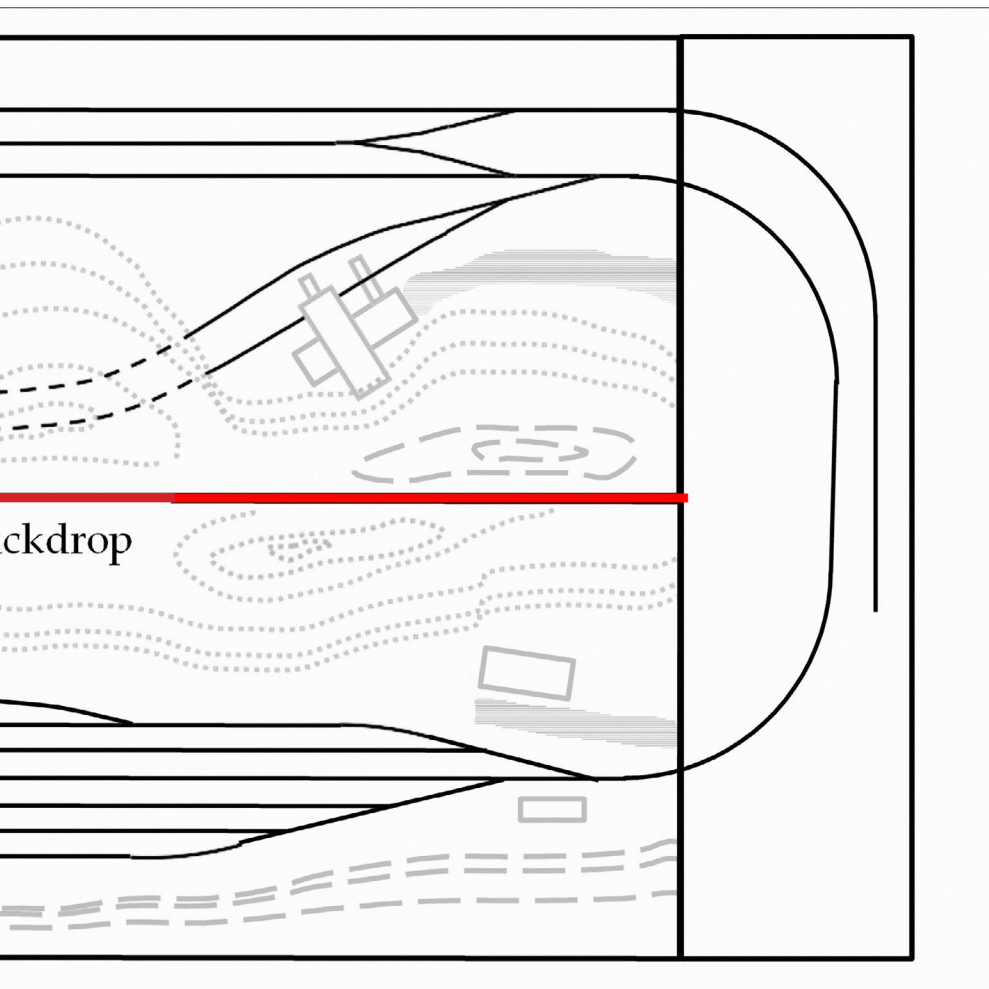

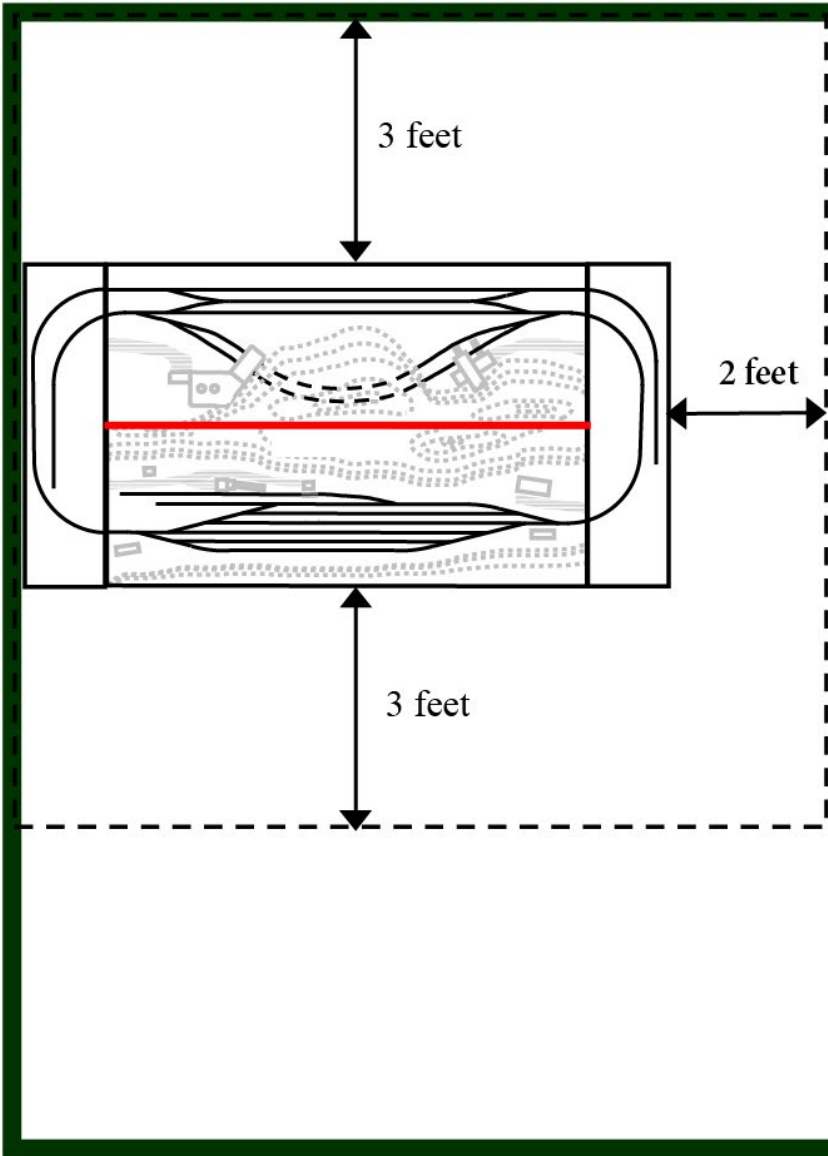

7. Island layout positioned in basement. Required footprint for layout and crew access is about 10 x 10 feet.

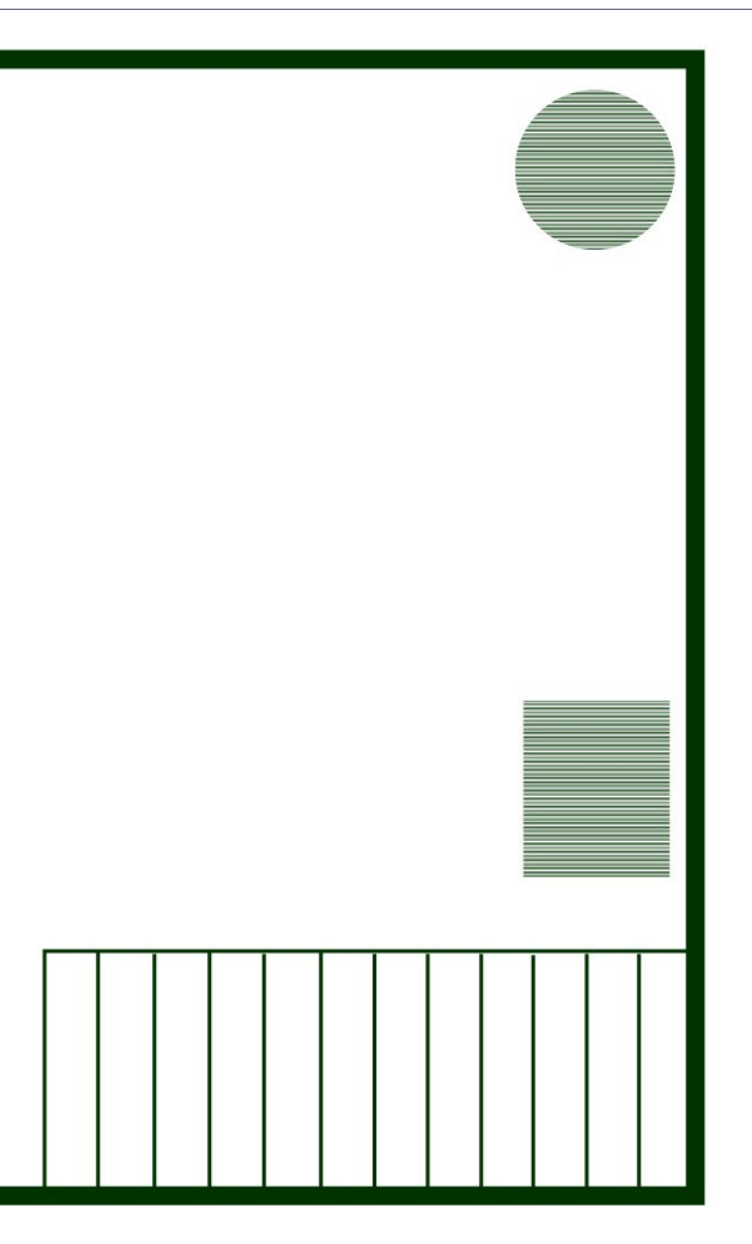

ONE MODULE CHALLENGE | 13

Given the operational drawbacks of [6] and my longer range plans for the layout, I elected to begin this *TOMA with a Twist* configuration as shown in [8-9]. There would be six modules, each between one to two feet wide and six to seven feet long,

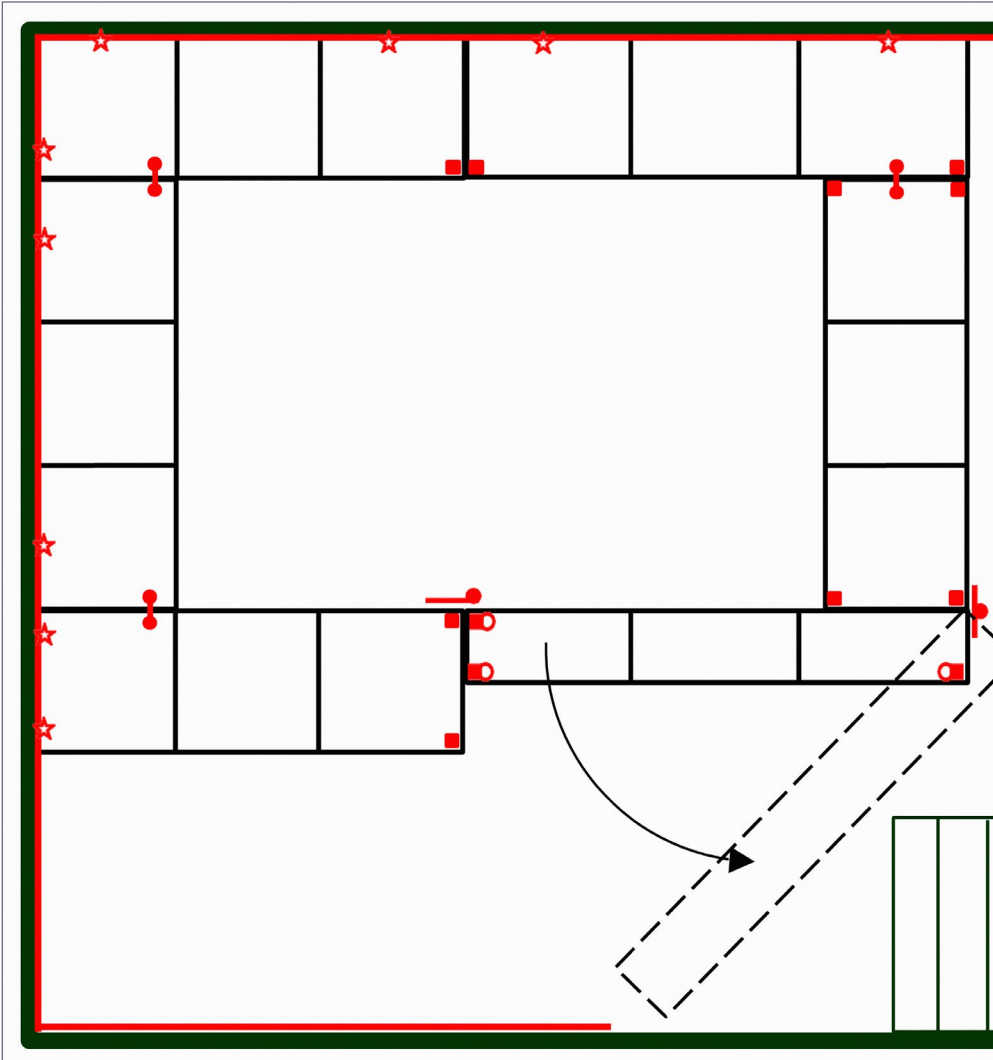

8. Stage 1 benchwork construction: module benchwork in black, supporting structure in red.

ONE MODULE CHALLENGE | 14

built using open grid benchwork. The grids are constructed of three-inch-wide plywood pieces, cut from a 4 x 8-foot sheet of $\frac{3}{4}$ " thick plywood. The pieces are glued and screwed together with $\frac{1}{2}$ " plywood sheet attached on top.



KEY

- | wall ledge
- legs
- ▣ legs with casters
- └ hinge
- └ latch
- bolt
- ★ flat brace



ONE MODULE CHALLENGE | 15

To support the modules, a wooden ledge is screwed into place along the three basement walls at the desired height, approximately 48" from the floor. Depending on how the wall is made,

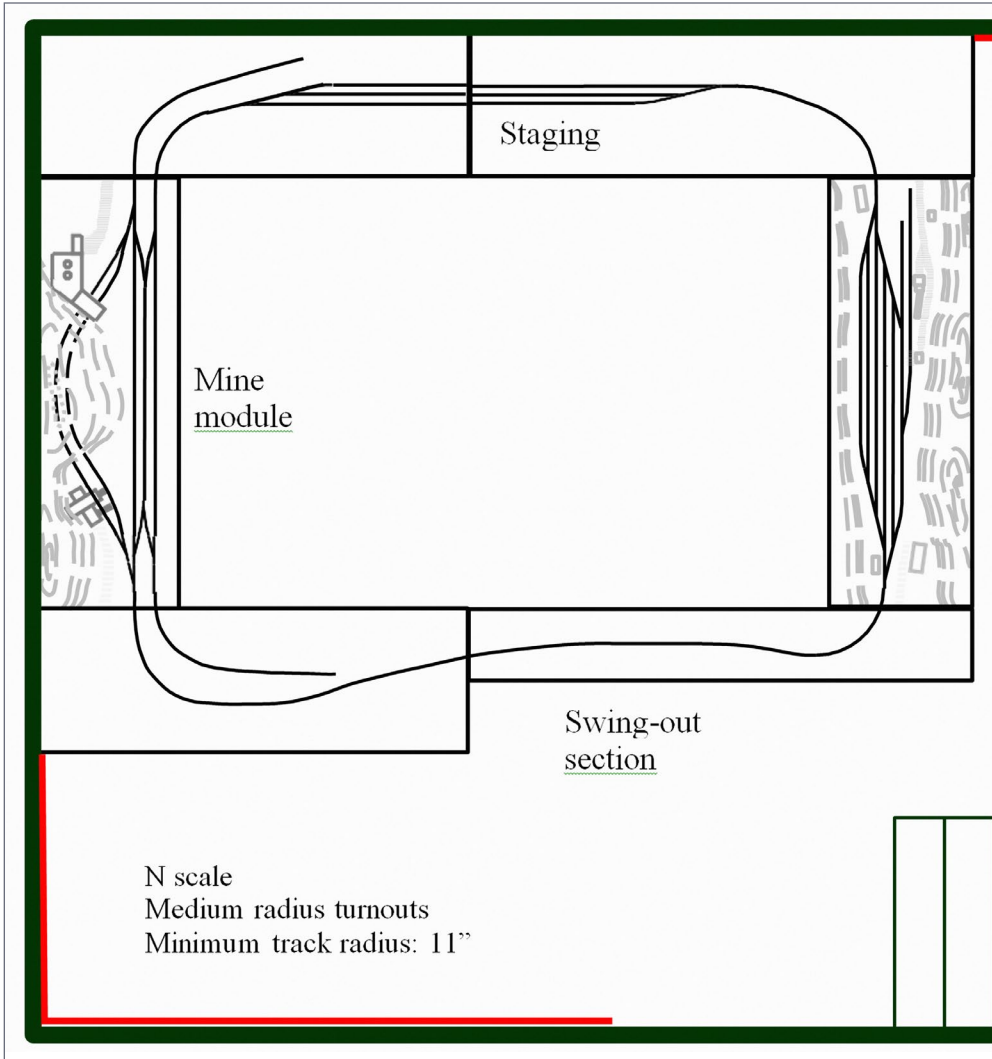

9. Stage 1 module layout and track plan. Overall layout dimensions are 8 x 13-feet. A 6 x 9-foot inside area is available for the operators, accessed via the swing-out section.

screws into the wall studs or self-tapping screws designed for concrete will hold the ledge firmly in place.

Where the modules contact the walls, they sit on the ledge and are secured using flat braces screwed to both ledge and module.

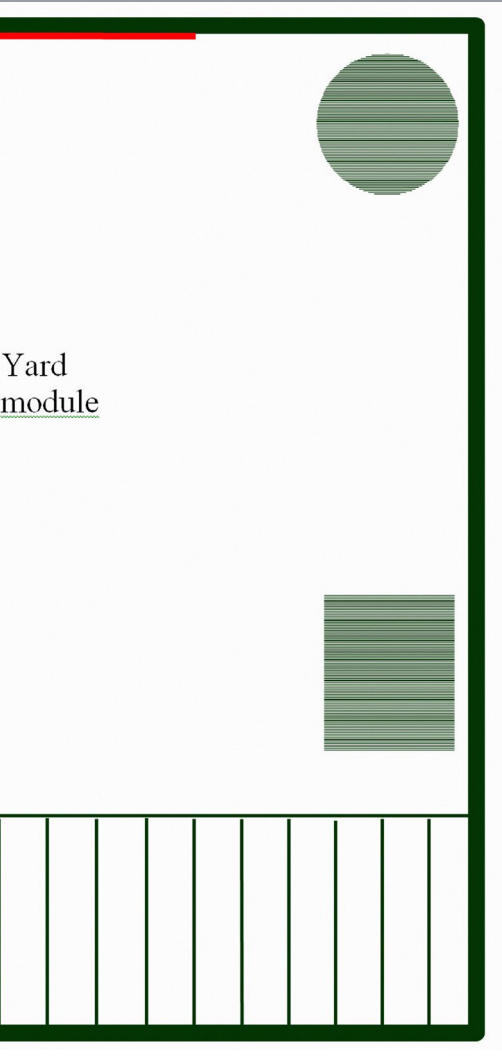

For other locations, legs bolted to the modules, or modules bolted together, provide the support structure. For those who don't like to "duck under," I've shown how a swing-out section could be incorporated using a hinge. Casters on the legs supporting the section allow for rotation, opening a space for the operators to enter. A simple latch holds the swing-out section in its closed position when operating.

I've provided an estimate of the materials needed to build Stage 1 in Tables [1-3]. Table 1 provides details on building the benchwork. Table 2 summarizes the track and electrical components. I've specified Peco Insulfrog turnouts, which will simplify the wiring, but Electrofrog turnouts

could be substituted for those who prefer live frogs. Both types of turnouts are the same price.



Table 1. Component list for Stage 1 supporting structure and benchwork.

Component	Quantity	Function	Comments	Cost
4 x 8-foot plywood, 3/4" thick	1	Module benchwork structure	Cut plywood into 3" wide strips: 8 strips 6' long, 4 strips 7' long, 20 strips 22.5" long, 4 strips 10.5" long	\$35.00
4 x 8-foot plywood, 1/2" thick	3	Module subroadbed	Cut plywood into sections: 4 pieces 2 x 6', 1 piece 2 x 7' and 1 piece 1' x 7'	\$70.00
1 x 4-inch pine, 8 ft. long	5	Ledge on walls	Cut two of the boards to 7' long	\$40.00
2 x 2-inch pine, 8' long	6	Legs	Cut each in half to form 12 pieces 4' long; later adjust lengths as necessary	\$40.00
1 x 2-inch pine, 8' long	4	Bracing for legs	Cut to length as required	\$30.00
3/16" self tapping screws 2 3/4" long	25	Fastening ledge to walls	Tapcon brand, white steel	\$7.50
Flat braces 5/8" wide x 4" long	12	Fastening modules to ledge		\$7.50
3/4" wood screws	1 pkg.	Securing flat braces		\$5.00
1 1/2" wood screws	1 pkg.	Fastening module benchwork		\$10.00
Wood glue	1 bottle	Fastening module benchwork		\$5.00
1/4" bolts, 3" long with nuts and washers	24	Module and leg connections		\$20.00
2" swivel casters	3	Swing-out section movement	Made by Everbilt	\$10.50
2 1/2" black barrel bolt	1	Swing-out section locking	Made by Everbilt	\$3.00
2 1/2" oil-rubbed hinge	1	Swing-out section rotation	Made by Everbilt	\$4.00
			Total:	\$287.50

Table 2. Component list for Stage 1 track and electrical. All track is N scale Code 80.

Component	Manufacturer	Quantity	Cost
RH medium radius turnout	Peco SL-395	11	\$180.00
LH medium radius turnout	Peco SL-396	11	\$180.00
Medium radius wye turnout	Peco SL-397	2	\$32.00
Flextrack, 3-foot sections	Peco SL-300	32	\$170.00
Cork roadbed, 3-foot sections	Midwest Products	40	\$35.00
Bus wire	14AWG, 25'	2	\$14.00
Feeder wire	24AWG, 25'	2	\$8.00
Rail Joiners	Peco		\$10.00
Track nails	Atlas		\$4.00
Total:			\$633.00

There are several options for tackling the project: build all benchwork sections first and then lay track, or work on a subset of modules. I suggest building and installing the three benchwork sections on the left side first. The cork roadbed and track would be laid in place. The mine module could be rotated on the connecting bolts to provide easy access for the wiring. In short order, trains would be running back and forth.

Next, the yard module could be built. The front of the benchwork should be notched one to two inches to allow a hill to be formed in front, using foam scenery. The rear hills, also made out of foam, would sit on the plywood top. The module could be set on a table and flipped on its side for ease of track laying and wiring.

Note that Peco turnouts have built-in springs so that ground throws are not necessary. Once the track is laid and checks out,



Table 3. Component list for Stage 1 scenery materials.

Item	Details	Quantity	Cost
Ballast	Woodland Scenics fine gray, 57.7 in3	2 pkgs.	\$26.00
Dirt	For ground cover and roads	As necessary	
Crushed coal	Woodland Scenics mine run coal, 10.8 in3	1 pkg.	\$5.00
Foam	DOW Foamular, 2' x 8' sheet, 2" thick	2	\$42.00
Paint	Acrylic spray paint: brown, gray		\$20.00
Trees	Woodland Scenics fine leaf foliage, light green	1 pkg.	\$18.00
Bushes	Woodland Scenics foliage clusters, light green	45 in3	\$12.00
Fixative	Woodland Scenics scenic cement		\$10.00
Grass	Woodland Scenics fine turf, burnt grass	18 in3	\$4.00
	Woodland Scenics coarse turf, burnt grass	18 in3	\$4.00
Total:			\$141.00

the yard section would be connected to the benchwork along the wall and the final swing-out section could be built and added. Then, after connecting all the tracks, trains would be able to run around the circuit, from yard to industries and back.

With the track and wiring installed and debugged, it would be time for detailing the yard and mine modules, as well as building structures. I have several comments regarding some of the recommended structures:

Coal mine: Coal mines came in all shapes and sizes. For the module, a mine that extends out from the hill over the loading tracks would be optimal [10]. The best available N scale kit is probably the classic Model Power Coal Mine kit, which I believe is based on a Jack Work original design. With careful painting and weathering, this plastic kit could be made to look like dilapidated wood, with lots of character. The upper shaft house should be cut so that the main body sits closer to the hill. The two outermost loading tracks — those with the most visual interest — would be used on the module.

Power plant: Consistent with the *loads in, empties out* approach, I was looking for a structure that resembled a power plant, but had two tracks entering the structure. While browsing through the Walthers monthly flier, I happened upon a structure that fit the bill:



LOADS IN, EMPTIES OUT

How can we make it easier to deal with open top cars where it's obvious they're not really loaded when we pull them from the industry? The famed late Dean of track planning, John Armstrong, suggested a loads-in/empties out pair of industries placed back-to-back, separated by a backdrop.

You model a shipping industry (eg., coal mine) on one side of a backdrop and on the opposite side you model a receiver (eg., power plant). Loads entering the power plant pass through the backdrop and reappear as coal loads at the mine. Conversely, empties going under the coal tipple reappear on the other side as empties at the power plant. It's self-maintaining!

This allows loaded hoppers to go in one direction and empties in the other without needing to manually load and unload the hoppers.





10. Example of a coal loader suitable for modeling. This building could be connected to a mineshaft, but it's equally possible it is connected to a conveyor belt or a truck dump. There is probably a space for sorting and grading coal in the structure, with different sizes loaded on different tracks. This mine was part of the PV&K coal company in eastern Kentucky.

**When talking
to hobby
vendors,
please
remember to
mention MRH.**

**VIEW READER
COMMENTS**

click here

**TOP VIEW
OF DIESEL
HOUSE,
WITH
TRACKS
ENTERING
STRUCTURE**

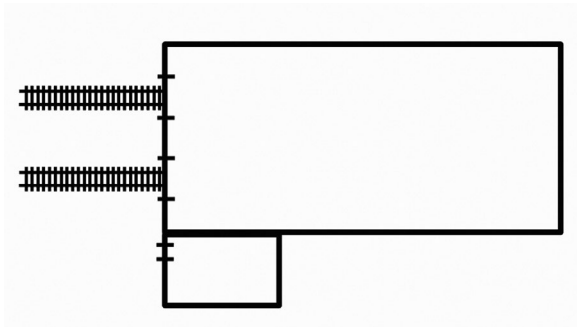

**CUT
SECTIONS AS
SHOWN AND
SEPARATE
SIDE
BUILDING**

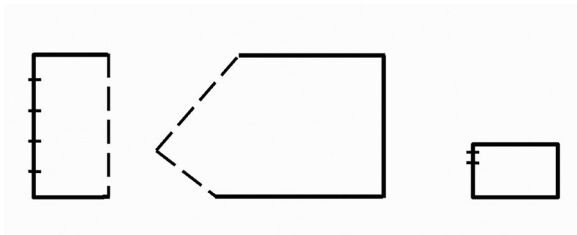

**REASSEMBLE
PARTS AND ADD
SMOKESTACKS**

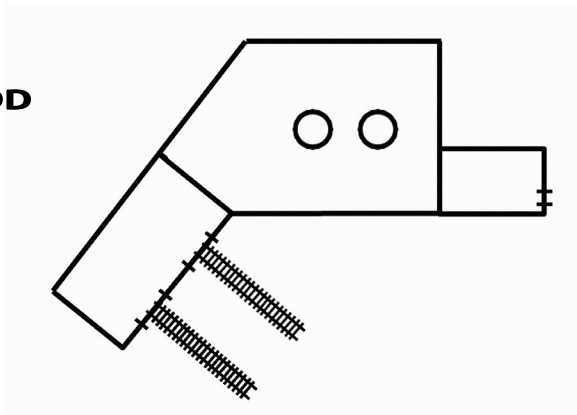

11. Kitbashing steps to convert the Walthers Diesel House to a power plant for use on the mine module.

the Walthers Brick Diesel House. A few simple cuts and rearrangement of this structure would yield a fine model. The steps in [11] show how this could be done.

Coal Loader: There were several coal loaders at Elkhorn City — modeling one would be sufficient for our purposes. The December 2012 and January 2013 issues of *MRH* featured construction articles by Tom Patterson on a coal loader that would work well here. He based his on a Clinchfield design. Tom’s model was HO scale, but it could be built in N scale without too much difficulty. Or, you could build your own from a suitable array of kits and components. The Walthers Cinder Conveyor and Ash Pit is one such possible kit.

Other small structures at Elkhorn Yard included a track scale to weigh the coal loads, a yard office, utility sheds, and a fuel tank. Table 4 is one possible structure list.

Don’t forget the telephone poles!

Table 4. Recommended structure list

Structure	Model	Cost
Coal mine	Model Power Old Coal Mine	\$30.00
Power plant	Walthers Brick Diesel House	\$45.00
Large shed	GC Laser Shim Shed	\$8.00
Small shed	Woodland Scenics Built-up Wood Shack	\$16.00
Office	BLMA Yard Office	\$17.00
Fuel tank	NGINEER Fuel Storage Tank	\$10.00
Track scale house	Woodland Scenics Built-up Work Shed	\$16.00
Coal loader	Scratchbuilt or Walthers Cinder Conveyor and Ash Pit	\$26.00
Telephone poles (12)	Atlas	\$4.00
Total:		\$172.00

Operations

Over the years, both the Clinchfield and the C&O used several different types of hoppers to move coal [12], including capacities of 55, 70 and 100 tons. These models are available from Atlas, Bachmann and Bowser, among others. The layout could support four main cuts of hopper cars; each cut would be about 40 inches long, which is the approximate length of the longest sidings on the yard and mine modules. Two of the cuts would always be loaded and the other two, always empty. These cuts would be traded between the yard and mine module in a regular sequence.

An additional set of hopper cars could be alternatively loaded or empty as they cycle between staging and the Elkhorn coal loader. These loads could be built to be removable using a magnet, as described by Mike Holly in the August 2016 issue of MRH. Mike also models in N scale; in the article, he describes how he weathers his hoppers and creates the removable loads.

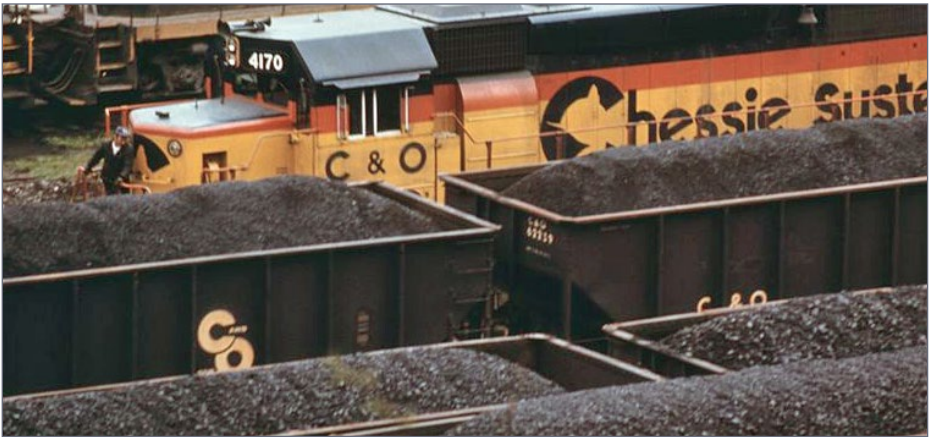

12. Close-up of C&O engines and hopper cars loaded for shipment at the Danville train yard near Charleston, WV. In 1974, the date of this picture, this was one of the largest shipment points for coal in the world.



For variety, a few boxcars, flatcars, and tank cars could be inserted into the trains, carrying supplies to the yard, mine, and power plant as necessary. The actual sequence of operations would be up to you. Given the need to closely operate locomotives from both railroads on the layout, I recommend DCC control, but the layout could be wired for DC control as well.

The yard tracks are arranged simply to promote efficient transfer, storage and switching of cars while allowing engines from both railroads room to maneuver [13]. The two longest yard tracks are used primarily for train transfers while the adjacent tracks are used for storage and the thoroughfare tracks are kept open so

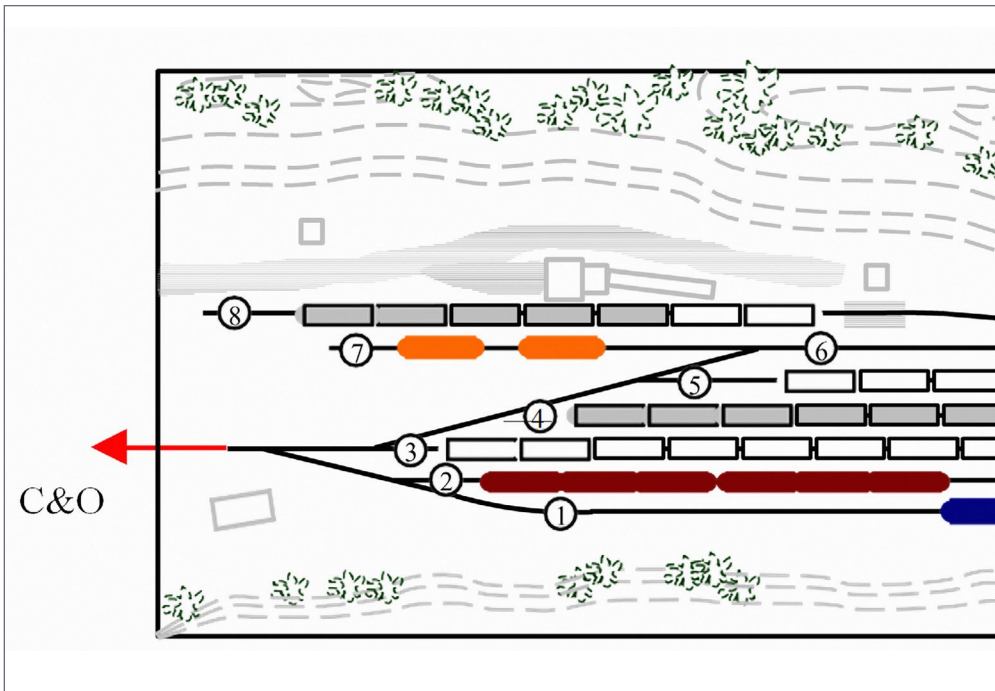

13. Elkhorn yard operations: (1) and (6) thoroughfare tracks; (2) and (5) storage tracks; (3) and (4) transfer tracks; (7)

Tell your friends about MRH!

We depend on word-of-mouth to grow ... if you don't share us, we don't grow

that engines can run around the trains. A local yard engine can switch the coal loading track during lulls in the transfer movements. Caboosees may be stored on the dedicated caboose track.

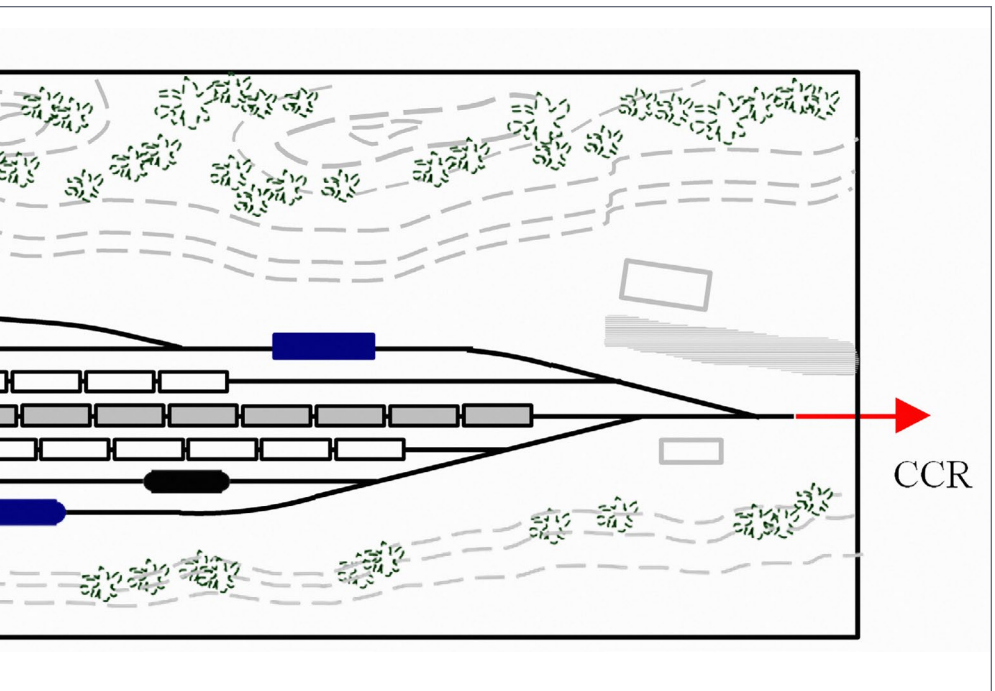

caboose track and (8) coal loading track. Engines are indicated in blue.



Stage 2 configuration

A wye and a small engine facility stood at the north end of the Elkhorn yard. For Stage 2, these features can be added [14]. Adding this track enhances operations as engines from either railroad can be turned and serviced prior to their return

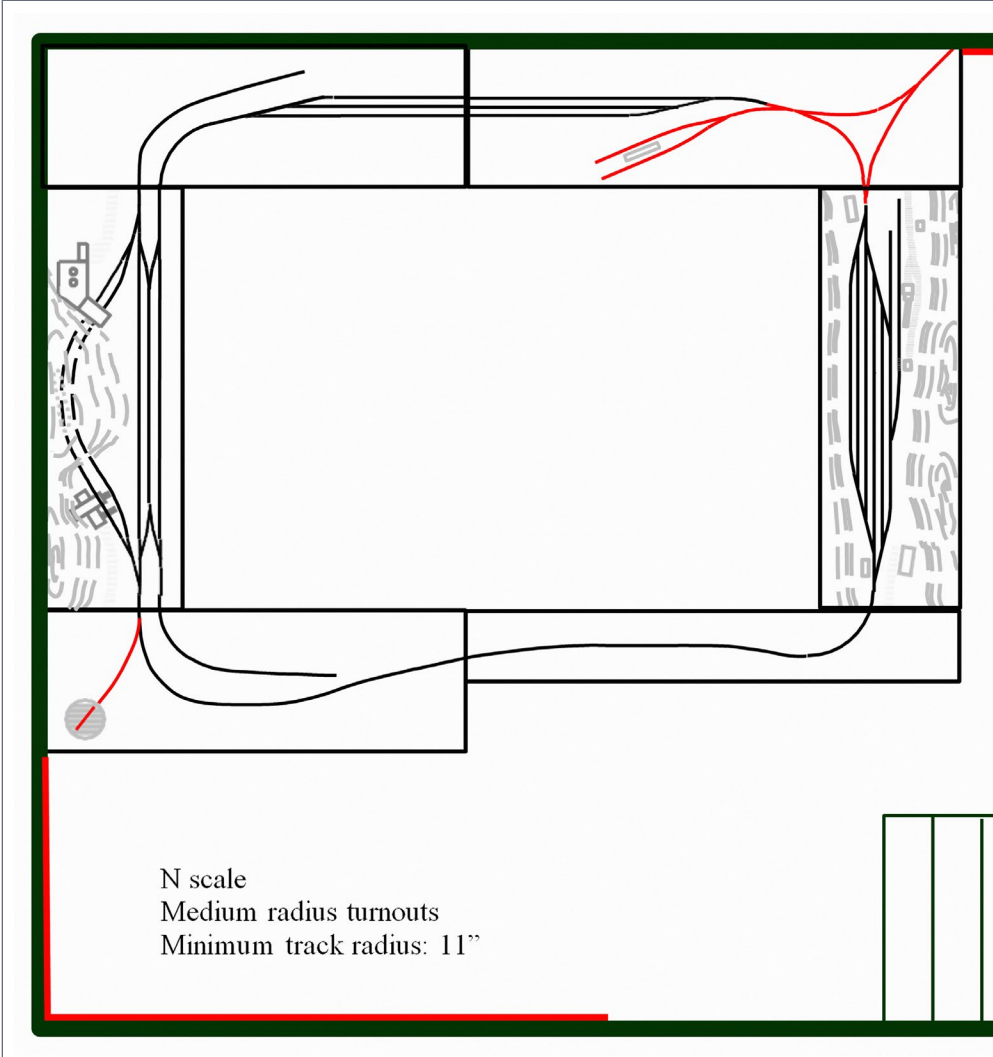

assignments. A small between-tracks diesel service station—including fuel, sand, and water—would work well here. Stewart’s Products offers some good choices for the service station.

A turntable may also be added near the mine to turn the local engines. In this way, engines can be preferentially oriented for both north and south directions along either line. In most pictures I’ve

seen, the locomotives ran short hood forward for improved visibility; however, for safety purposes, there might be a preference for running long hood forward. This would also allow for back-dating to the steam era.

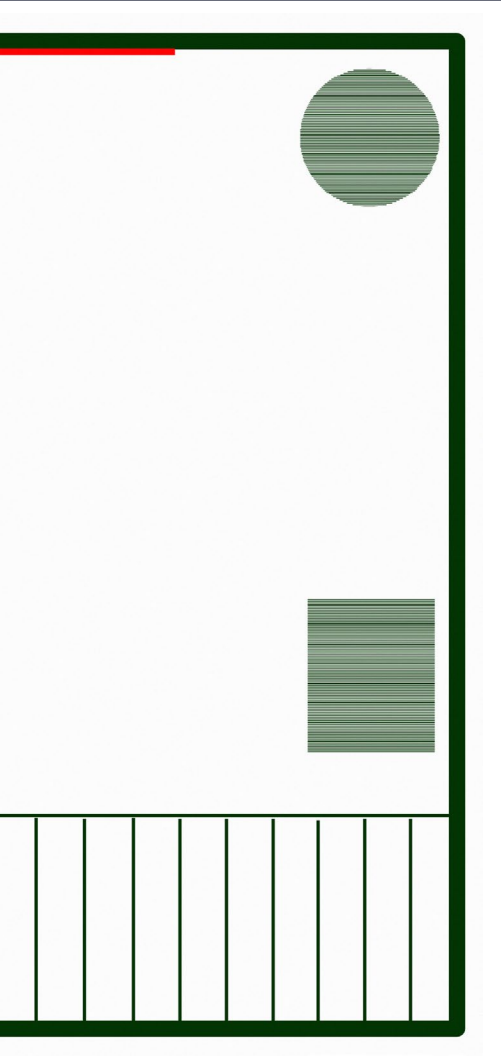

**VIEW READER
COMMENTS**

click here

14. Stage 2 module layout and track plan. Turning tracks and service facility are added, as indicated in red.



Final configuration

In the longer term, the layout can be expanded as shown in [15]. In this arrangement, Elkhorn and its connecting modules move to the upper right while the mine module and its neighbor move to the lower left. Three additional modules fill the gaps. The

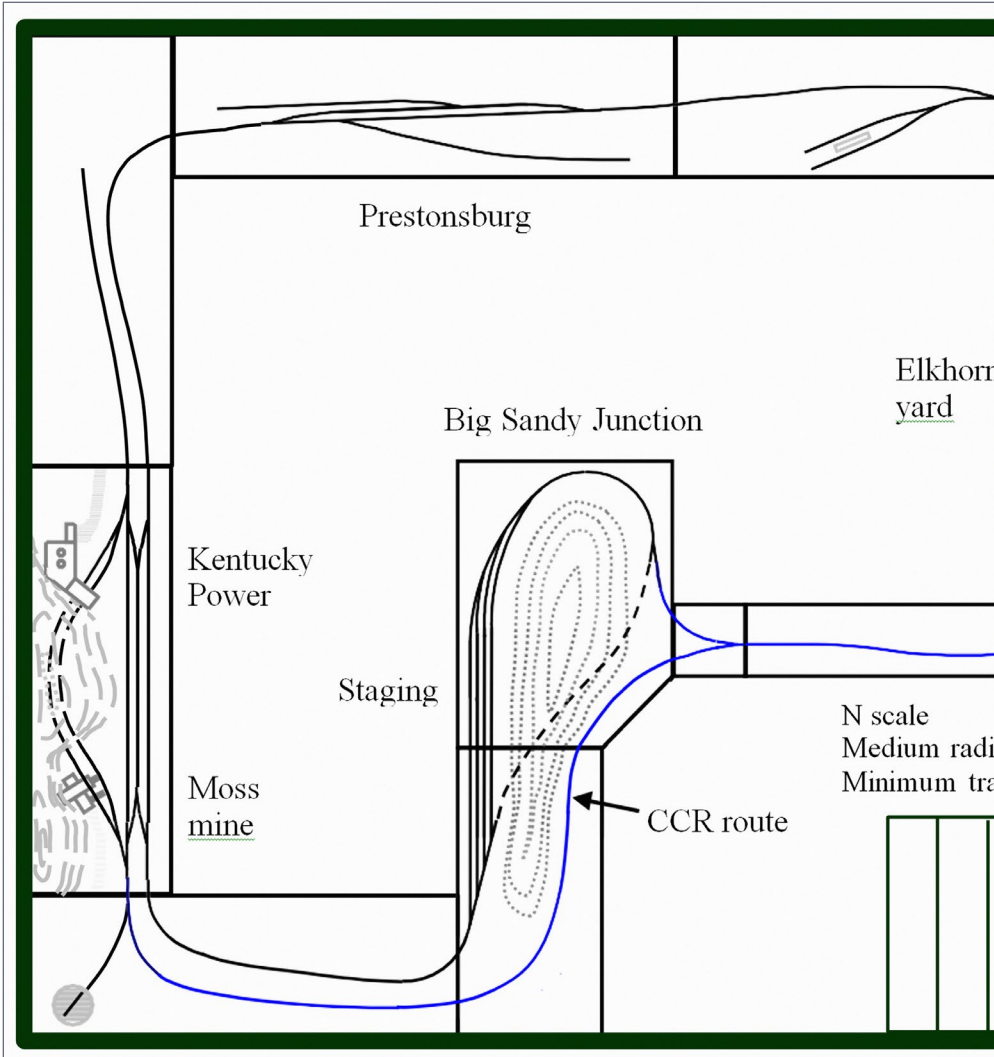

swing-out section is shortened one foot to allow the wye and curved track to be permanently installed, making the track alignment easier.

The final arrangement increases the mainline running distance for both railroads and also provides staging for both railroads. Up to four people can comfortably operate the layout.

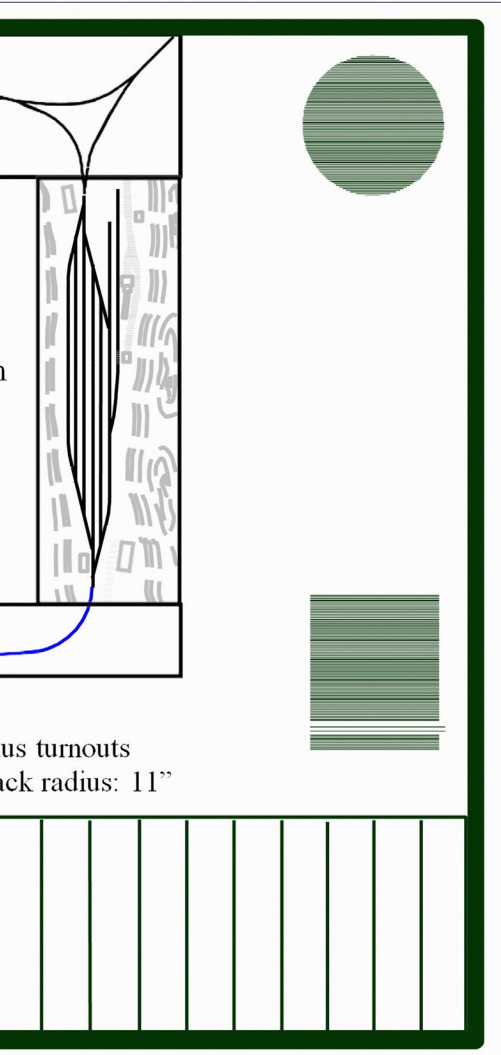

return loop (hidden under hills) allows northbound C&O trains to reverse direction and return as southbound trains. Or, southbound trains from staging could travel all the way through Elkhorn, along the Clinchfield line and back into staging for later use. Prestonsburg — midway between Elkhorn and Big Sandy Junction — allows for switching variety beyond the usual coal traffic. Industries here could include a lumber yard and a freight transfer station.



RATE THIS ARTICLE

15. Final module layout and track plan.



Scenery

There are plenty of scenic opportunities. Tree-covered hills could be modeled at the rear of the modules, rising to meet backdrops along the walls; some of the front benchwork sections may be trimmed to better follow the track and create a free-flowing edge if desired. The track plan is flexible and may be altered to suit your needs.

I would avoid putting in too much track; having stretches of mainline between switching locations allows room for trains to breathe and improves the operating experience.

All the sections are portable and could be removed from the basement easily. The module designs allow flexibility in future layout arrangements if a move is required. The heart of the layout is the opposing set-up of the yard and mine modules; any number of modules could be fashioned between them to fit the available footprint at a new location. Even a room as small as 10 x 10-feet would work if the island layout design [6] was adopted.

I think this would be a fun layout to operate – switching cars and swapping trains with fellow operators. And fun, after all, is what this hobby is all about.

**Please include
a phone number
when emailing
MRH**

**(in case your spam
filters eat our email
response)**

**VIEW READER
COMMENTS**

click here

PETER VASSALLO



Peter lives in Albany, NY and works as a mechanical engineer. This design project takes him back to his roots as he had an N scale layout as a boy growing up in Buffalo, NY. Now, he models mostly in HO scale and favors western railroads, particularly the narrow gauge lines of Colorado and California. An article on his HOn3 Alistair Road layout was published in the May/June

2017 issue of the *Narrow Gauge and Shortline Gazette*. He has had articles published in *Model Railroader* and *Model Railroad Hobbyist*. ■

**Use our custom
Google search on the
MRH website to find
topics of interest**

CLICK TO FIND OUT MORE





Modeling a **FRISCO USRA 2-8-2**

Model Railroad Hobbyist | July 2018 | #101

DON WIRTH shares tips on modifying a stock brass USRA loco to better represent Frisco 4026 ...

A WHILE BACK, I FOUND AN AKANE USRA LIGHT 2-8-2 for sale online at Brass Trains (brasstrains.com). Having modeled the Frisco from the steam days since the mid-'60s, I had modeled Frisco 4000-class Mikes some four times over the years using PFM models, but never using an Akane.

I am impressed with how well the Akane brass model represents the prototype. I received the model, ironically painted and lettered



RATE THIS ARTICLE

Pennsylvania [1]. I say ironically because the Frisco received many of their USRA light Mikes from the PRR!

After totally disassembling the loco, I soaked it in lacquer thinner. The paint came off very quickly and thoroughly [2]. I ended up with a model as clean as a pin. Time to start making the modifications.

Removing unwanted detail

The shop crew (that's me) stripped the detail from the engine's boiler [3]. This stripping process involved a lot of unsoldering using several tools: a resistance unit, 250W soldering gun, and a 40W iron (see the sidebar on Soldering/Unsoldering).

After unsoldering, I removed all the excess solder, cleaned the holes, and filed/sanded things smooth. The domes, stack, and all other boiler-mounted items were removed. I also removed the cab and boiler backhead, as well as the smokebox front.

Collecting the new detail parts

The Stores Department (that's me again) gathered the Frisco-specific accessories, castings, and detail parts in preparation for the rebuild [4]. I used castings from PIA, PSC, Cal-Scale, Cary, and some custom castings in the rebuild.

I filed parting lines and sprue remains off the castings prior to installing them.



FRISCO USRA 2-8-2 | 3

I dealt with the removed parts by passing them to the reclamation crew (that's me again). Some smaller parts, such as cab doors and windows, I reused in the rebuild.

There was not much that I could reuse, since the Frisco changed the appearance of these locomotives by replacing the trailing trucks with Delta castings, and installed straight running boards and steps from the running board to the pilot.

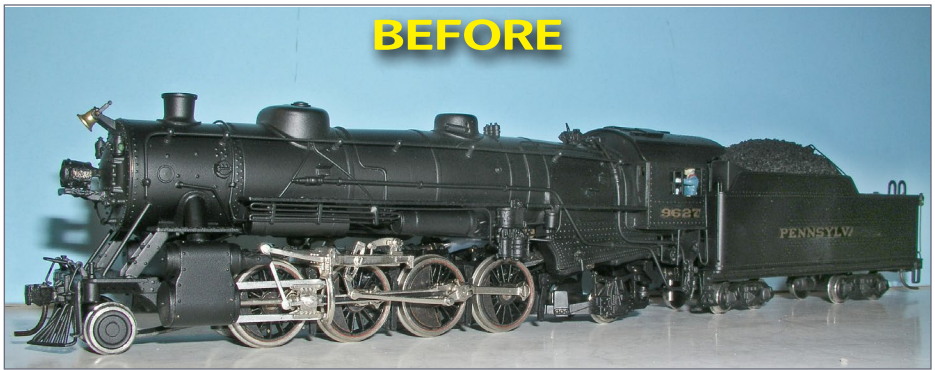

1a. The original Akane brass 2-8-2 painted for the Pennsy.



1b. The final upgraded Frisco model of 4026.

These changes gave the engine a businesslike appearance reeking with the “Frisco” look. I think the distinctive headlight, bell, and coonskin number plate really made the loco front end handsome.



2. The disassembled model after stripping the paint.



3. The model with some of the unwanted boiler detail unsoldered and removed. I went on to also remove the running boards, cab, boiler backhead, and smokebox front.

Starting the rebuild: the cab and surrounds

As mentioned, I removed the running boards, cab, backhead, and smokebox front, as you can see [6].

As delivered, the USRA cab was on the small side, and the big strapping Ozark boys likely banged their heads on the low roof



4. All the collected parts used in this rebuild.



5. Parts I removed – I did not use most of these parts on my Frisco model.

inside. Some of the Frisco replacement cabs maintained the USRA arched roof appearance but had taller new sides and ends.

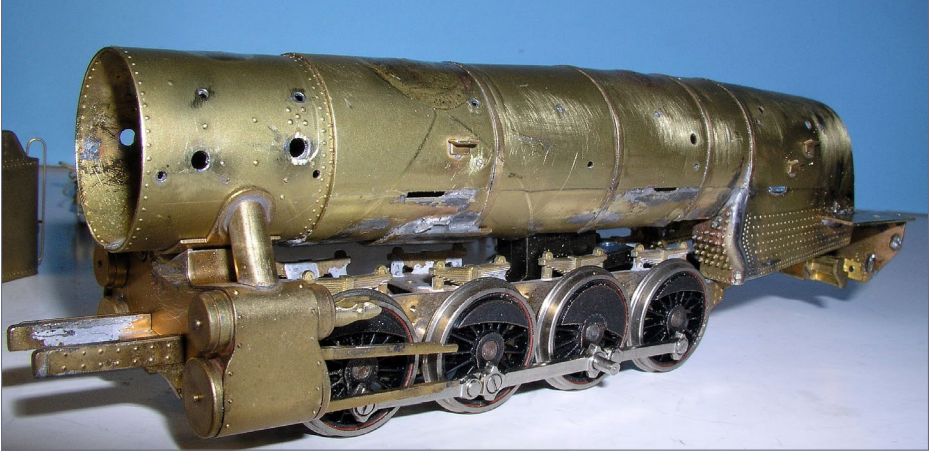

6. The stripped boiler minus all the detail, running boards, cab, boiler backhead, and smokebox front. To start the rebuild, I added firebox front sheet castings.

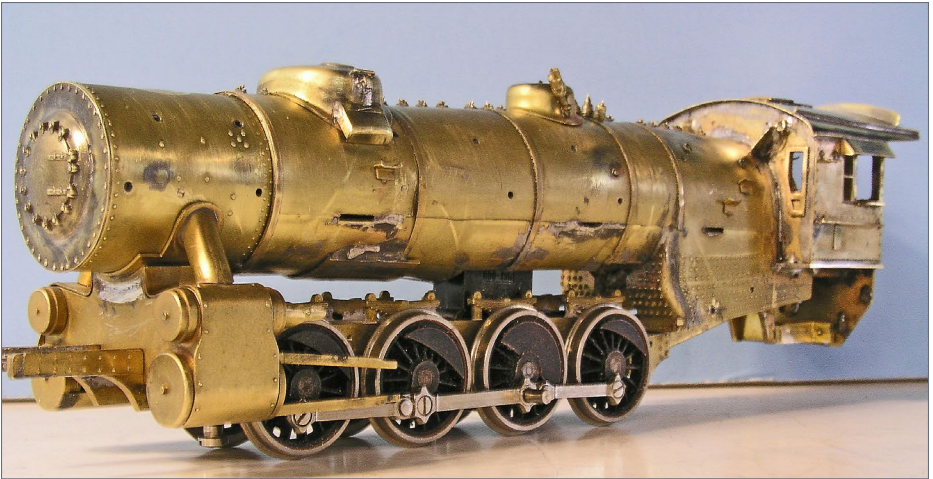

7. Progress so far with the new cab installed domes replaced, and the new smokebox front in place.

The engines with the arched roof cabs looked very tall, and the roof of the cab was 3' above the top of the boiler, somewhat ungainly looking, actually. I chose to model the 4026 with the “standard” Frisco cab.

As a first enhancement, I added firebox front sheets [6]. These castings that add a great amount of detail to a somewhat-ignored area.

I installed the new cab and replaced the domes with ones having a whistle and sanding valve covers [7]. Next, I put the new smokebox front in place. At this point it's starting to resemble a Frisco locomotive!

Frisco engines had a distinctive look to them, like some other southwest roads. Missouri Pacific, MKT, and Texas & Pacific engines were all true southwest engines. Frisco always had a



8. Progress so far, showing the loco from the cab end.

well-balanced look to their engines, and I found them always to be distinctly recognizable.

Looking at the locomotive from the rear [8] shows more of the scratchbuilt cab features as altered by the Frisco.

Next, I added more detail to the fireman's side and top of the boiler: air pump, starter valves, boiler checks, turret valve, new

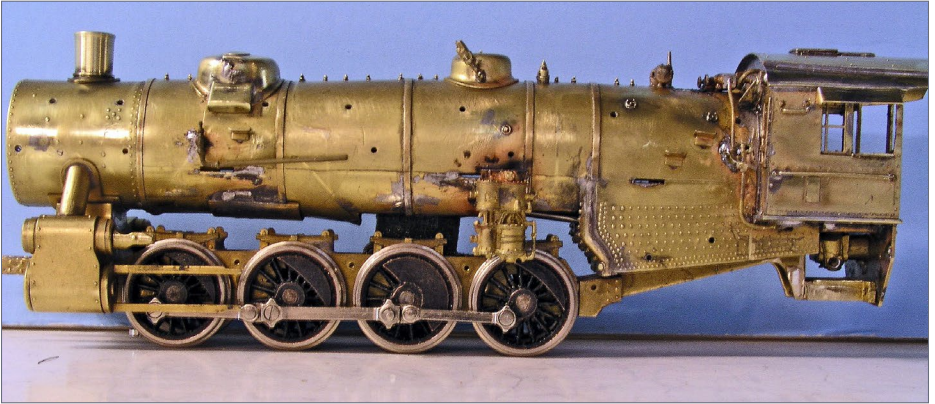

9. Adding more detail to the boiler [fireman's side].

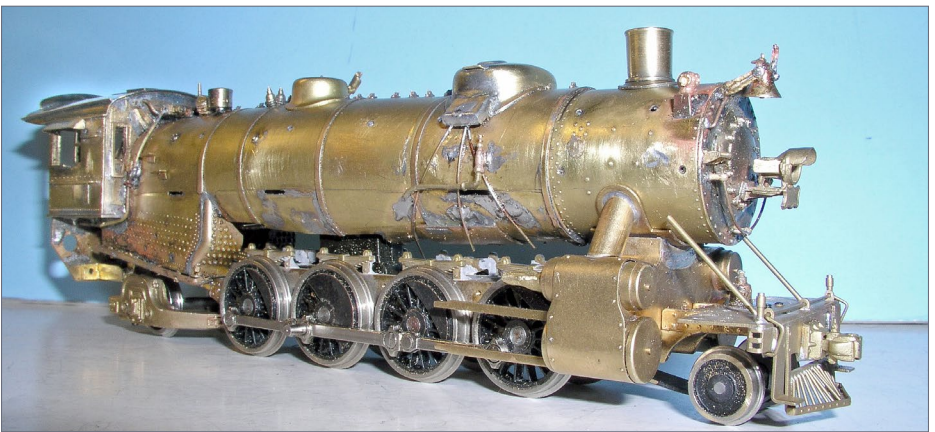

10. Considerable detail has been added.

stack, and dynamo [9]. Frisco was a big user of Chicago injectors and starting valves. They fitted a few of the “smaller” engines with feedwater heaters. The loco is really starting to take shape now!

Next I added the front pilot, Pyle national class lights and brackets, the front headlight and bracket, bell, and other miscellaneous smokebox-front detail. I also added a blowdown muffler, as well as a boiler check and starter valve. I added sand pipes and put ash-pans on the bottom of the firebox [10].

I assembled the trailing truck and installed it, making sure it was leveled and true. Frisco used trailing truck boosters on many of their engines with Delta trailing trucks. I also kept adding more piping [11].

I’ve always felt Frisco engines seemed to have such a balanced and well-proportioned front end [12]. The headlight sits just slightly below center with the coonskin number board and the front-mounted bell – all very attractive, I think.

I continued to solder on more detail: waist sheets (mid-boiler support), furnace bearer (rear-firebox supports), booster engine,

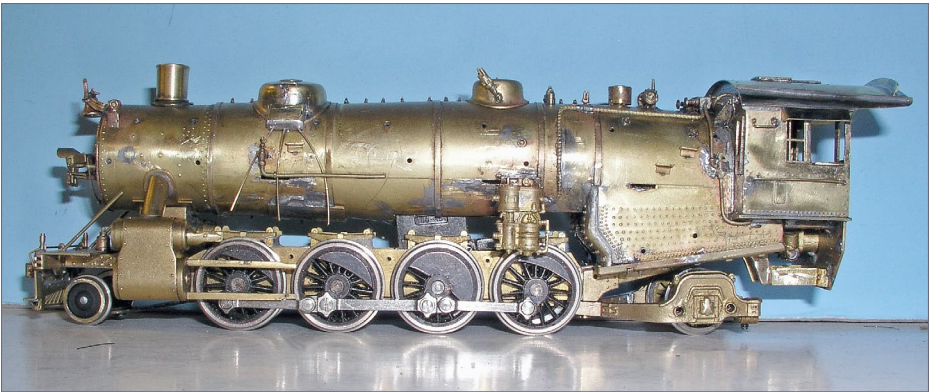

11. More piping being added to the boiler.

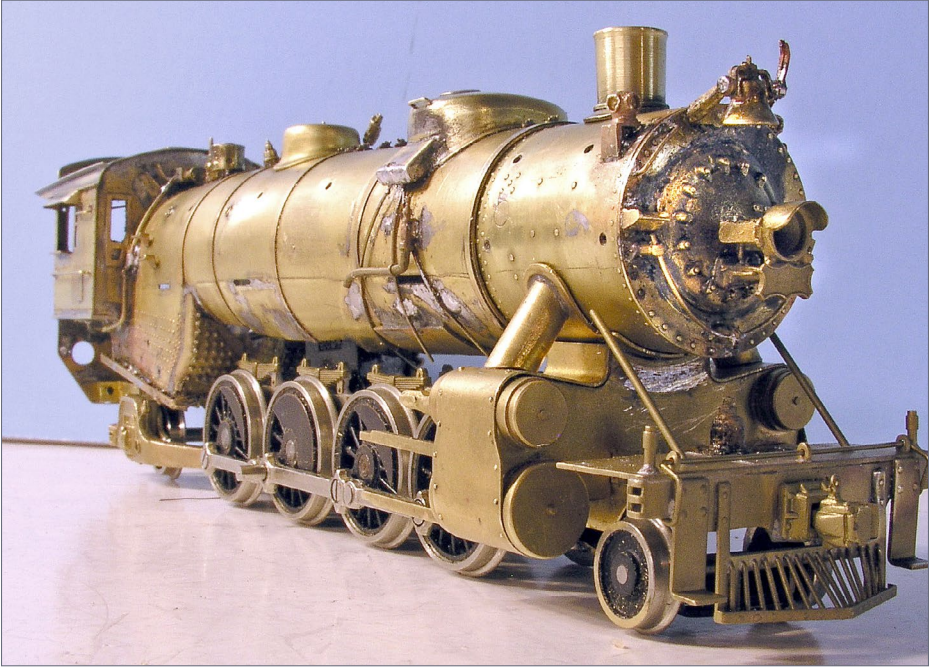

12. The loco is starting to get its Frisco face.

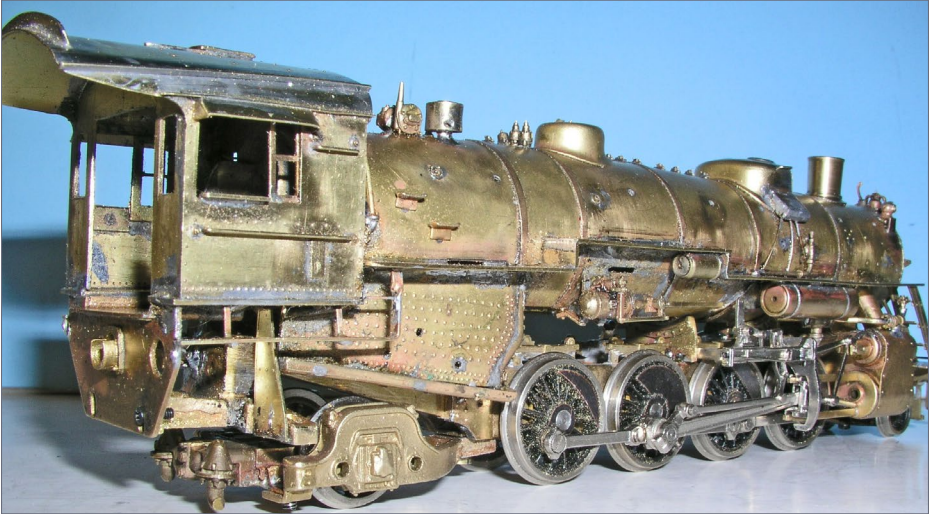

13. More major detail added to the engineer's side.

running board, power reverse, front steps, and air reservoirs [13]. The engineer's side is really taking shape.

Working on the fireman's side, I added the running boards, steps and air reservoirs [14].

I finished up all the piping on the fireman's side and turned my attention to the tender [15].

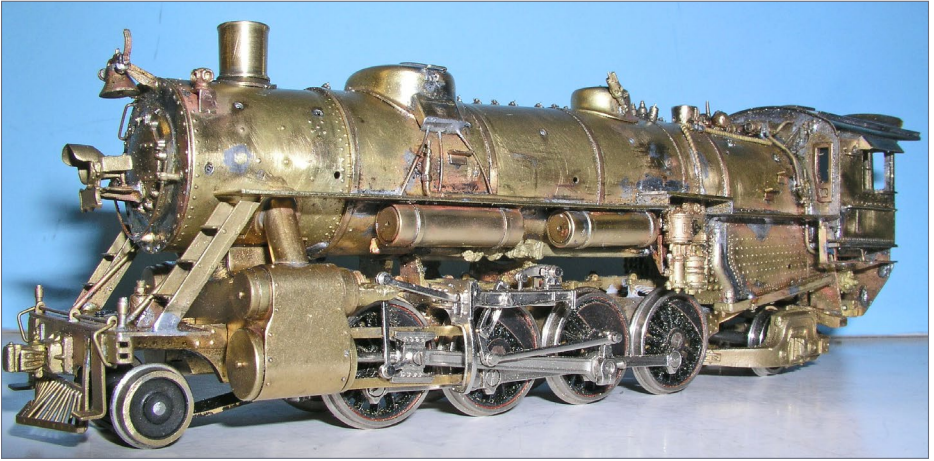

14. Progress on the fireman's side with more detail added.

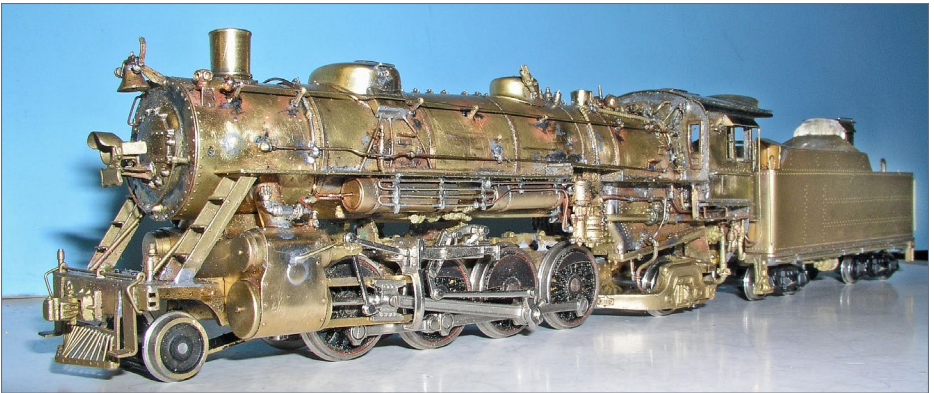

15. Fireman's side is complete – time to move on to the tender.

Frisco-izing the tender

Next, I worked to “Friscoize” the tender [16, 17].

The Frisco put brakemen’s “doghouses” on the tenders since the cabs really weren’t big enough for the head brakeman. Plus, the Frisco added other details specific to their practices: some of the 4000-class locos had built-up sides on their coal bunkers, for example. The 4026 does not have these built-up coal bunkers, however.

The finished product

Once I finished the loco, I painted and weathered it, then put it into service on my 1943-era Rolla Subdivision of the Frisco [18, 19, 20, 21].

I painted the loco with Scalecoat L. For the wheels and running gear, I used Tru Color black with some gray primer mixed in. I lettered the loco with decals made on my old ALPS printer, and weathered it with chalks.

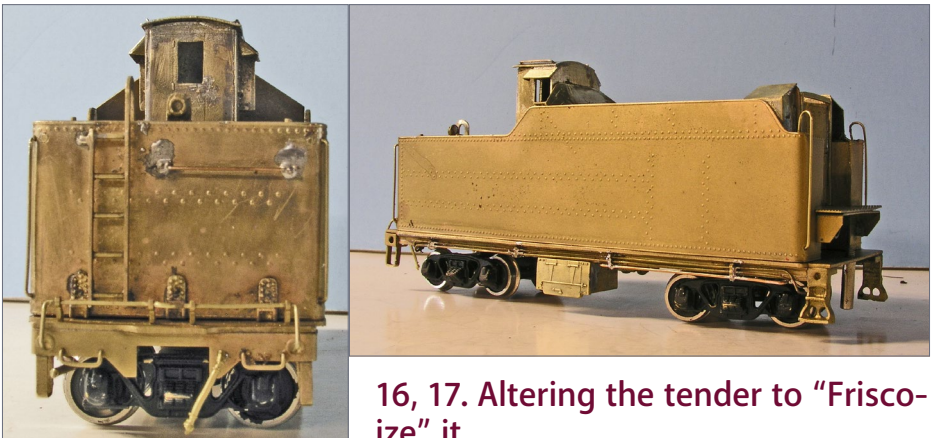

16, 17. Altering the tender to “Frisco-ize” it.



18. Fireman's side of the finished loco.



19. Engineer's side of the finished loco.



20. Front view of the finished loco.



21. Rear view of the finished loco.

This was an enjoyable project and I'm pleased with the outcome. In fact, I just found another one of these locos on eBay, so I bought it.

I will let it sit and mellow on the back track of the shop for a while... you just never know what might come out of the loco shops here!



Please tell your buddies about MRH!



SOLDERING/UNSOLDERING ON BRASS LOCOS

One of the things I get asked about is soldering and unsoldering. Let me give you some basic pointers – hopefully, these will answer many of your questions.

I don't have what I would call "exotic" tools in my shop. I do have a 250W American Beauty resistance soldering unit with tweezers (and honestly, I don't use the tweezers that much) and a single electrode with it. I have altered the electrode hand piece from 3/32" to 1/8" so I could use general copperclad rods save money, since the electrodes wear out with use.

To alter the electrode, I reamed the hand piece out to 1/8" and bought a box of a hundred 1/8" Arcair-brand copperclad rods from a welding house for less than fifty dollars.

These are carbon rods in a copper sheath just like the 3/32" diameter rods sold with the unit. These work very well and the rods last forever. The Arcair rods come 12" long – I cut them to match length of the existing rods that come with the unit. I conservatively have a 200 year supply of electrodes!

This unit is great for either removing or soldering castings on. One caution: Do not touch the "piping" on a model with this type of soldering unit, as it vaporizes small diameter wire!

Next, I have a small Weller soldering station with adjustable wattage from 5 to 40 watts. This is great for working with smaller details.

Finally, I have a Weller 250W soldering gun, but I don't use it as much as I used to.

On the soldering station, I use a Weller 40W pencil with a screwdriver-shaped tip for the smaller soldering, while I use the resistance unit for the medium to large jobs. If I can't get

enough heat with the pencil on the smaller jobs, then I move to the gun. But I mostly use the 40W pencil and the resistance unit.

No matter what you use, I follow these fundamentals:

1. First, make a good, strong mechanical joint.
2. Whatever you are soldering must be clean – both the part and what you are soldering the part to.
3. I use a paste flux which I've used for 40 years called NOKORODE. It is non-corrosive and cleans up nicely. The goal is a nice, shiny bright joint.
4. Don't use any more heat than is necessary.
5. Protect other soldered parts close by with either a piece of wet tissue or a heat sink. A pair of tweezers or similar will act as a heat sink and keep the heat localized.

My ultimate goal is to be able to pick up the model by the part I've just soldered on.

Soldering is not rocket science, nor is it a rare art. Gather up some brass scraps and practice, practice some more, and then practice still more.

You will find that you won't fear soldering after doing plenty of practice first. Clean the parts, get a solid mechanical joint, use flux, and don't over-apply the solder. Avoid big globs.

When people tell me they can't do soldering, I tell them all the same thing: Hey, I'm 6'3", weigh 265 and my hands are huge. If I can solder successfully, *anyone can*. ■



RESISTANCE UNIT

You can find an American Beauty resistance soldering unit similar to what Don describes on Amazon.

WEB: a.co/790yMsg



DON WIRTH



Don was born into a Frisco family – his dad was an engineer on the Frisco Rolla Sub between St. Louis and Newburg, MO. Don grew up listening to his dad’s stories of running steam, and became hopelessly

hooked as a little kid, being in love with steam all his life.

Don started modeling the Frisco in HO back in 1965. A series of *Model Railroader* articles by Bob Darwin on the art of steam loco superdetailing in the 1960s changed Don’s whole outlook on how to model steam locos. He also learned a lot from his friend Joe Collias – one of the best steam modelers Don has ever known.

During the 1970s, Don worked on some projects for the brass importers, as well as doing model steam painting to keep his hobby “mad money” coming in.

In 1985, Don’s model work took a back seat to the prototype when he became involved in the restoration of Frisco 1522. In 1988, Don became FRA-certified as one of the three engineers of 1522 and was made its Chief Mechanical Officer. When 1522 was retired in 2002, Don got back into HO modeling and has been at it ever since. ■



RATE THIS ARTICLE

Waiting a

MONTH

just too long?

Get your
weekly
What's Neat
fix on
YouTube!

What's Neat
This Week

with Ken Patterson

Watch on



WEEKLY VIDEO PODCAST!

Check it out >>

*Watch Ken's What's Neat This Week video
podcast on YouTube each week!*

• [INDEX](#)



SUBSCRIBE
(free)

• [TABLE OF CONTENTS](#)

You're the kid.



Welcome to the candy store.

- 180,000 square feet of “candy”
- The world’s best known manufacturers
- 44,000 square feet of modular layouts
- “Ask the Collectibles” appraiser
- Trains, accessories, collectibles & more
- Hands-on demonstrations

**CLICK HERE
FOR ALL THE
DETAILS!**

www.nationaltrainshow.org

August 10-12, 2018
Kansas City
Convention Center
301 West 13th St.
Kansas City, MO

© 2017 NMRA

Sponsored by



We make it more fun!

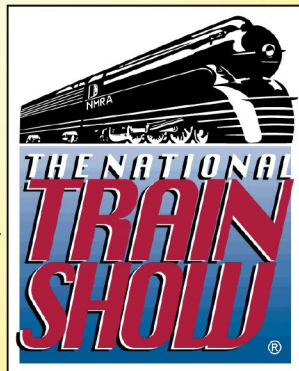

• [INDEX](#)

• [TABLE OF CONTENTS](#)

JULY NEWS

column



Model Railroad Hobbyist | July 2018 | #101



RATE THIS ARTICLE

RICHARD BALE and

JEFF SHULTZ report the latest hobby industry news

Fourth generation to lead Walthers



Stacey Walthers Naffah, great granddaughter of company founder William K. Walthers, will take the throttle at Walthers effective September 2018. Stacy succeeds her father, Phil Walthers, who will become chairman of the board. Stacy has been vice president of sales and marketing since 2013. She joined the family business in 2009. Her resume includes

People magazine, Reader's Digest and the advertising agency J. Walter Thompson Co. Stacy is a graduate of Boston College and earned her MBA at Northwestern University. Stacy is a past president of the Model Railroad Division of the Hobby Manufacturer's Association and is the current president of the World's Greatest Hobby, a non-profit organization that promotes model railroading as a hobby. Walthers is a major manufacturer, distributor, and direct seller of model railroad products. The company

► [THE LATEST MODEL RAILROAD PRODUCTS, NEWS & EVENTS](#)

• [INDEX](#)



[SUBSCRIBE](#)
(free)

• [TABLE OF CONTENTS](#)

employs about 80 people in its 114,000 square-foot headquarters in Milwaukee.

Dead Rail Installs, Tam Valley Depot

Dead Rail Installs is now the exclusive North American distributor for all Tam Valley Depot dead rail (Power on Board) products. Dead Rail Installs is an established firm owned and operated by Pete Steinmetz. The company specializes in sales and installation of radio-controlled battery operated systems for model trains. It is also an authorized dealer/installer for BlueRail Trains, SoundTraxx, and CVP Airwire Products. For additional information visit deadrailinstalls.com. Tam Valley Depot will continue to manufacture and market its core line of products that includes Frog Juicer, QuadLN_S loconet decoder, Turtle Stall motor driver, SwitchWright switch machine, DCC Train Shuttle, DCC Booster, and Octopus III. For additional information visit tamvalleydepot.com ...

Sergent Engineering releases patents



Sergent Engineering has made the patents and designs for Sergent couplers available to the public domain. The surprise announcement was made by Frank Sergent who developed the unique couplers and has been manufacturing them

for the past 20 years. He has decided it is time to step back and pursue other interests. Prototype modelers working in HO scale consider Sergent couplers the most authentic model of a full-size North American railroad coupler available. Anyone seriously interested in manufacturing Sergent HO scale couplers, or developing them for other scales, can contact Frank Sergent at info@sergent-engineering.com ...

Monster Modelworks for sale

Jimmy Simmons, the creative talent behind Monster Modelworks, has announced that his company is for sale. Simmons stated that seven intense years of developing hundreds of highly detailed laser-etched structures and related components has taken a toll on his creativity. Simmons and his wife Lisa have decided it is time for a life reboot and a change of direction. Interested parties with serious offers can contact Simmons at jimmy@monstermodelworks.com ...

Ozark Miniatures expanding

Ozark Miniatures, a specialty producer of large-scale products based in Cedar City, UT, has purchased Lone Star Bridge and Abutment Company. The newly acquired product line is being updated and is expected to be available for shipment by September. Other brands in the Ozark Miniature family of large-scale products include Hartford F-scale kits, Hartland Locomotive Works, Sheridan Products, Precision Products 3D veneer sheets, CDS dry transfer lettering, Larry Larson Graphics, and Air-Ezze remote turnout controls For additional information visit ozark-miniatures.com ...

Rail-Scale-Models purchases Rusty Stumps laser-cut details

Rail-Scale-Models, best known as a supplier of laser-cut structure kits and detail items in a variety of scales, has acquired the rights to manufacture the line of laser-cut details developed by Rusty Stumps Scale Models. Items involved in the acquisition include shingles, fencing, crates, pallets, doors, windows, and laminated



wall sheets. Walter Gillespie, owner of Rusty Stumps Scale Models, said the sale will give him more time to focus on developing cast and 3D printed details, and producing more kits. Gillespie noted that he has recently acquired a second SLA 3D printer.

.....

NEW CLUB CARS



The Chicago & North Western Historical Society is selling a limited run of Kadee HO scale PS-1 boxcars decorated as CNW No. 809 and No. 153. The prototype cars were

built in 1954 at Pullman Standard's plant in Michigan City, IN. The HO scale ready-to-run models represent prototypes repaired in the 1960s and repainted in the then-standard black car cement on ends, roof, and underframe; freight car red sides, and two slightly different versions of CNW's distinctive yellow-lettering scheme. For additional information visit cnwhs.org.

.....



Kits for this custom decorated HO scale 70-ton triple-bay hopper car with offset sides are available from **Division 4, Mid-Central Region of the NMRA**. Four numbers are available, with the option of eight additional numbers using a special decal supplied by Accurail, which produced the kit. The decorating scheme portrays Davies Steel cars built in the late 1940s. For additional information go to www.div4.org/sub_pages/company_store_page.htm.

.....

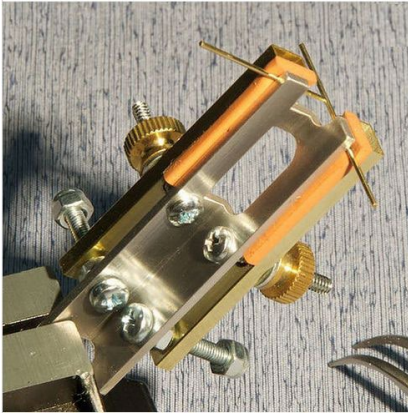

Coffman Engineering has introduced a new website at coffmaneng.com and announced their newest corner clamp, the AC-8-3 Mini Combo Right Clamp. With a jaw length of one inch, the clamp features a vise tab at the end for hands-free operation, high temperature silicone rubber pads to allow the modeler to solder while the pieces are in the clamp, two sets of

V-grooves to hold small wire, tubing, and other structural shapes at right angles, and thumb nuts on the end screws. Coffman Engineering can now be reached at a new email address, randyl@coffmaneng.com. For more information see the website above.

.....

NEW PRODUCTS FOR ALL SCALES



New animated electric signs from **Miller Engineering** include this rooftop Illinois Central Railroad sign. It is available in two sizes: 1.8 x 2.2-inches wide, and 3.7 x 4.25-inches wide. A flashing Illinois Central window sign is also available.



A flashing roadside billboard for KOA has recently been added to the Miller lineup of electric animated signs. For additional information including a demonstration of both signs visit www.microstru.com/Coming-soon.html.

.....



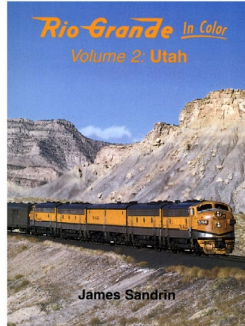
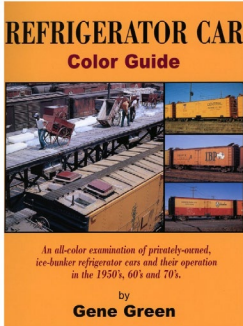

Morning Sun has released two digital reprints from its extensive library of previously published hardbound books. *Refrigerator Car Color Guide* by Gene Green is an in-depth look at the operation and roster of

privately-owned ice-bunker reefer cars. An interesting feature is a sequential study of the icing procedure atop an icing dock in 1962.

Also available now as a digital reprint is *Rio Grande in Color Volume 2: Utah*, by James Sandrin. It was originally published in 1998. The digital version provides a station-by-station itinerary from Grand Junction, CO to D&RGW interchange with the SP at Ogden.

Morning Sun has a new hardcover book coming, *Bicentennials in Color, Volume 1: A to F*. It features over 300 color photos of locomotives, cabooses, and other equipment and structures specially painted for the United States' Bicentennial. A free 10-page downloadable preview is available at morningsunbooks.com/pages/red-white-blue-preview.

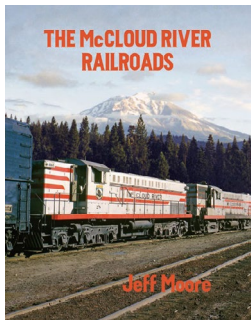

In his latest book, author Jeff Moore tells the story of *The McCloud River Railroads* that were built to serve the lumber industry located south and east of Mt. Shasta, one of the premier logging territories of California in the late 19th century. This handsome book offers 385 photographs plus 41 maps drawn by John R. Signor. For more information visit signature-press.com.

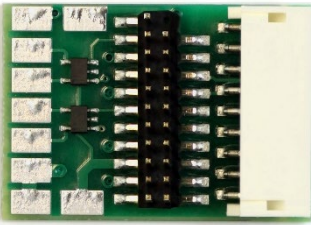

SoundTraxx has introduced a simple device (JST-21PNEM) that adapts any SoundTraxx 21PNEM decoder to an NMRA 9-Pin DCC quick-plug equipped model. The JST-21PNEM can also be used with a SoundTraxx 9-Pin JST Power Harness to create a universal-

style decoder. The JST-21PNEM supports up to eight lighting functions and has solder pads for CurrentKeeper, speaker connections, and extra lighting outputs. Dimensions of the new adapter are 22.5 x 16 x 7.5 mm. For additional information contact a Soundtraxx dealer or visit soundtraxx.com.

.....

O SCALE PRODUCT NEWS



3rd Rail Division of Sunset Models is booking reservations for an O scale model of a Virginian class EL-2B, the largest electric locomotive ever built in North America. The EL-21Bs comprised two permanently linked electric locomotives with a total of 16 powered axles. The locomotives were over 150-feet long and weighted in excess of 1 million pounds. The VGN used these locomotives on the 133-mile electrified portion of the railroad that extended from Roanoke, VA to Mullens, WV. 3rd Rail's O scale



version will be composed of an ABS body with brass details, manually working pantographs, and diecast ball bearing trucks. Three-rail versions will have ERR Cruise and TMCC. Models equipped for two-rail operation will use QSI Titan DCC.

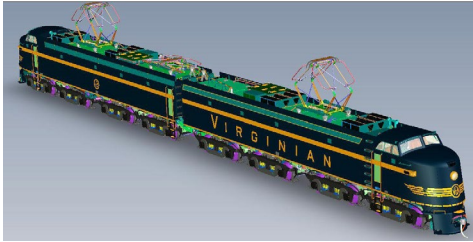

Although decorating the prototype for N&W was planned, it was not accomplished before the units were retired and scrapped. 3rd Rail will offer both VGN and N&W versions. For more information contact

a dealer or visit 3rdrail.com.

.....



Right On Track Models has released the James Watt Furniture Factory, an O scale craftsman style laser-cut kit. Components in the kit include laser-cut basswood, cast resin details, Tichy windows and doors, and white metal details cast by Berkshire Valley. The kit includes

seven standalone structures that can be arranged as shown, or in a variety of configurations. More add-on buildings are planned for release at a later date.



Right On Track Models has re-issued its O scale kit for Wilson Bros. Freight Transfer. The kit features laser-cut basswood with laser-engraved brickwork and components from Tichy and Berkshire Valley. The assembled model has a footprint of 16 x 10.25-inches. For

additional information go to rightontrackmodels.com.

.....



Rusty Rail has released a cast-resin kit for an O scale work shed. It is shown here with its roof removed. A few signs and a wall calendar are included. For a limited time a figure of a workman will be included with the kit. For more information visit rustyrail.com.

.....



Woodland Scenics has introduced the Old Weathered Barn in O scale, a fully assembled and painted structure. Details include a fieldstone foundation, shake roof, hay loft door and a weather vane on top of the slatted cupola. Also

included are a concrete grain silo, implement shed, and a printed interior. The structure includes pre-installed LED lighting that is intended for use with the Just Plug® Lighting System. For more information see your local hobby shop or go to woodlandscenics.com.

.....

S SCALE PRODUCT NEWS

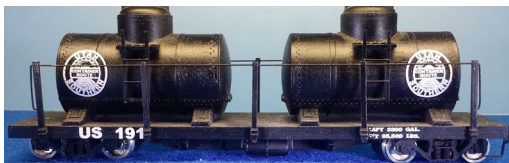

Precision Vintage Classics has released cast-resin kits for flat cars that, depending on the trucks selected, are suitable for

either Sn3 or On30 application. Models are available with either



wood or steel side sills. Also new is a short injection-molded plastic tank designed to be mounted on the flat cars.

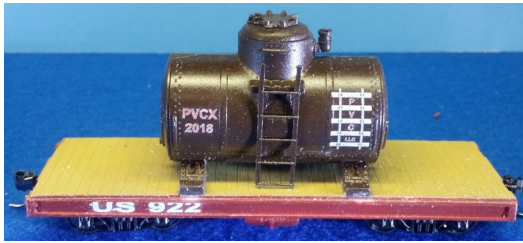

The kits include couplers but no decals. For more information contact Paul Vaughn at pev.sn3@gmail.com.



Pre-Size Model Specialties is selling an S scale kit for a general service composite gondola. The one-piece cast resin

model is based on a prototype car used by both Southern Pacific and Union Pacific railroads. The kit is available with and without decals. Trucks and couplers are not included. For more information visit pre-size.com.

HO SCALE PRODUCT NEWS

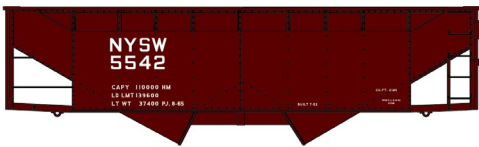

Accurail has released several new HO scale kits including one for this New York, Susquehanna &

Western 50-ton offset-side, twin-bay hopper car. The model represents a steel coal hauler built in 1952 and rebuilt in 1965.

Also new is a kit for a Wellsville, Addison & Galetton 40-foot single-sheathed wood boxcar. The model is based on a car



built in 1930 with Murphy metal ends and Youngstown steel doors.



A somewhat more modern car is this 40-foot Western Maryland AAR steel boxcar built with

Dreadnaught ends and fitted with Youngstown steel sliding doors. Accurail's HO kit replicates a prototype built in 1939. It was rebuilt in 1957.

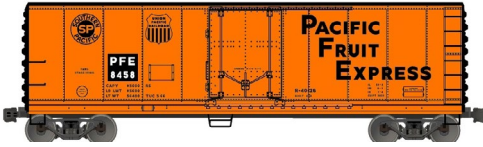

Accurail is selling this Pacific Fruit Express 40-foot steel ice reefer in a special 3-car pack with

different car numbers. The HO scale model is based on a class R-40-26 prototype introduced in 1951. Within a few years most new reefers would be built with some form of mechanical refrigeration.

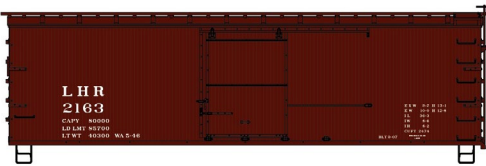

This 36-foot double-sheathed wood boxcar was built with a metal roof and Murphy corrugated steel ends.

Accurail's HO scale kit is decorated for a Lehigh & Hudson River car built in 1907.

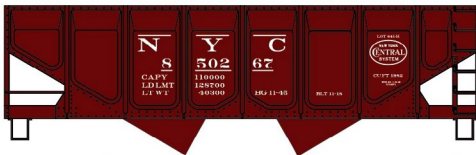

Two additional 3-packs of HO scale car kits from Accurail include a USRA 55-ton twin-bay hopper car



with panel sides, and an ACF covered hopper with three discharge bays. Both of the cars are decorated for New York Central.

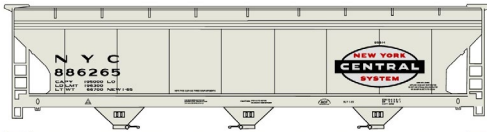

All Accurail kits come with appropriate trucks with plastic wheelsets and Accumate knuckle couplers.

For additional information contact a dealer or visit accurail.com.

.....



Athearn has added Norfolk Southern No. 6920 to its release of EMD SD60E diesel locomotives coming next May. No. 6920 wears a one-of-a-kind paint scheme that honors America's veterans. The Genesis SD60E mode represents a prototype rebuilt with a short "Crescent" cab. The HO scale model joins the previously announced No. 9-1-1 that honors First Responders (see MRH News February 2018).



PAINTING A PROTOTYPE

Ever wonder what it takes to paint a diesel unit? Norfolk Southern's painting team consists of some two dozen dedicated employees who need about 66 gallons of primer and paint to decorate a typical modern locomotive. The paint job takes about 112 hours to complete. You can watch the process by going to

www.youtube.com/watch?v=7h55AaK6rZ0.



Another late addition to a previously announced Athearn production schedule is UP No. 1943. Dubbed the Spirit of the Union Pacific, the locomotive honors a Boeing B-17 bomber funded by war bonds Union

Pacific employees purchased during WWII. Athearn plans to release the HO scale SD70ACe in December. Both the SD60E and SD70ACe locomotives described here come with a SoundTraxx Tsunami2 DCC decoder sound system that operates in both DC and DCC modes.

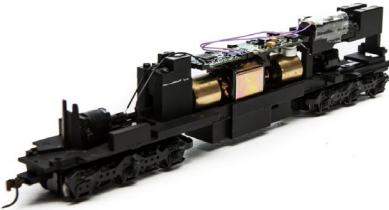

Athearn has announced plans to sell powered SD40T-2 and SD45T-2 chassis as a replacement under-frame for updating older Ready-to-Roll models. The new chassis will have couplers and coupler pockets

and an EMD 4500-gallon fuel tank. The trucks will come with Athearn's new HTC sideframes with Hyatt and Timken truck journal box options, however, these details are removable so the tank and sideframes from the original model can be retained. The stand-alone chassis will have the latest 21-pin DCC-ready motherboard and it will be sound-ready with a 16mm x 35mm speaker baffle. Eight LEDs to replace older light bulbs will be included. Availability is planned for April 2019.

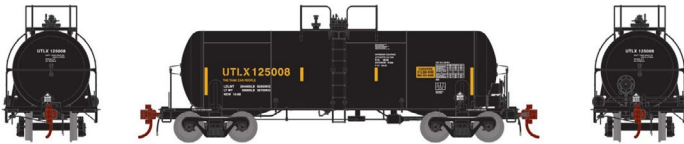

Athearn's May 2019 production schedule includes an HO scale 13,600-gallon acid tank car. Road-specific variations on the



Genesis model include body details, configuration of the top platforms, and the arrangement of brake rigging.

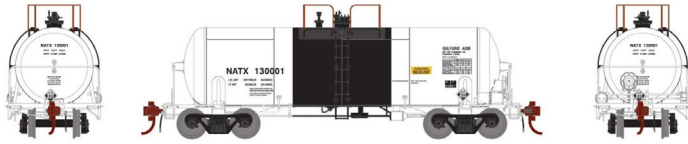

Road names will be UTLX (two schemes), Asarco Incorporated, Dupont, GE Rail Services, and Procor.



This 60-foot FMC boxcar with double 8-foot Youngstown sliding doors will be released by Athearn as an HO scale Ready-to-Roll model next May. This will be the first availability of this big car since the fall of 2015. Features include photo-etched metal cross-over platforms and separately applied brake wheel, grab irons, and end ladders. In addition to Conrail, road names will be CSX, Transportación Ferroviaria Mexicana, and three Cotton Belt schemes including an ex-Golden West car in faded Primed for Grime paint.



Several versions of a Pullman-built PS-2 twin-bay 2600 cu. ft. covered hopper will be available next May. Road names for the Ready-to-Roll HO scale model include M-K-T, CSX, Grand Trunk Western, Conrail, Chicago & North Western, and Rio Grande Chemical.

Both single and dual axle versions of an HO scale Freightliner tractor are scheduled for release next May. The model features



rubber tires and clear window glazing. Decorating schemes include BN and Union Pacific (above), and six basic colors. The orange version has a roof-top wind deflector.



Roundhouse brand models coming from Athearn next May include a 50-foot smooth side mechanical refrigerator car. The HO scale ready-to-run model

will be available decorated for Union Pacific (ARMN), Cryo-Trans, CSX, Americold, and Trinity Leasing (ex-BNSF in Primed for Grime scheme). For additional information on Athearn and Roundhouse products contact a dealer or visit athearn.com.

.....

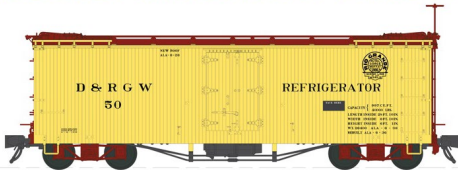

Blackstone Models is planning to complete the second release of its HO_n3 30-foot 20-ton D&RGW refrig-

erator car late this fall. Decorating schemes include the Moffat Tunnel herald (above) and the Flying Grande lettering (below).



The model is based on prototype cars rebuilt in 1926 with Murphy roofs, altered needle beams, and larger ice hatches. The ready-to-run model will have arch bar trucks with

4-foot 8-inch axle centers and Kadee No. 714 couplers. They will be ready for the addition of Blackstone's SoundCar digital sound



decoder. For additional information contact a dealer or visit blackstonemodels.com.

.....

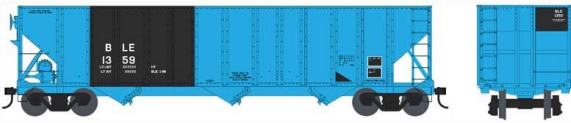

Bowser Trains is booking reservations for a new production run of 100-ton triple-bay coal hoppers. A release date of February 2019 is planned for the HO scale model. The prototype evolved from a 1960 N&W design. Increasing the height of the sides to 12-feet 3-inches raised the cars capacity to 3433 cu. ft. Construction of the larger car began in 1964 with more than 130,000 being built.

Spotting features on Bowser's HO scale version include roping eye with integral end buffers, end slope sheets that are at a steeper angle than the hopper sheets, and 13 riveted side posts with the two middle panels wider than the others. Additional details include Wine door locks, full height side ladder stiles, knuckle couplers, and roller bearing trucks with 36-inch metal wheelsets.



Road names will be B&LE (blue), B&O, BN, Chessie (B&O, C&O, and WM), CSX, NS, P&LE, PPLX, RBMN, Reading & Northern, CAN, and two versions of CAN on ex-LEFC cars. For additional information contact a dealer or visit bowser-trains.com.

.....

Broadway Limited Imports is selling an HO scale version of a massive Union Pacific 4-12-2 steam locomotive. The highly detailed hybrid model is constructed of brass and plastic. The

locomotive comes with Paragon3 sound and operating system suitable for both DC and DCC systems. It requires a minimum radius of 22 inches.



The 4-12-2 was the largest North American steam locomotive built with a rigid wheelbase. In the 1920s Union Pacific used 2-10-2 and 2-8-8-0 locomotives on main line freight trains

but both types were slow. Following a successful test of a three-cylinder 4-10-2, UP took the next step and ordered a 4-12-2 from Alco. The outside cylinders drove the third set of 67-inch drive wheels and a third cylinder, located in the center of the engine, drove the second axle. The first axle also had a crank to provide clearance for the center main rod. The design proved successful and Union Pacific eventually owned 87 of the giant 4-12-2s. They were superseded by Challengers and Big Boys. For additional information contact a dealer or visit broadway-limited.com.

.....



RUSSIAN 4-14-4

In 1934 Russia built a 4-14-4 that had 63-inch drivers on a rigid frame. The one-of-a-kind locomotive made one demonstration run during which it ripped the track apart. It was stored and later scrapped.



InterMountain Railway has announced plans to make another production run of its HO scale 1937 AAR boxcar with an interior height of 10-foot 6-inches. The release date is TBA. Features include metal wheelsets and Kadee couplers. IR's catalog describes the car as having 4-3-1 Improved Dreadnaught ends which would indicate the model is based on a prototype rebuilt sometime after 1944 when ACF introduced ends with the revised design.

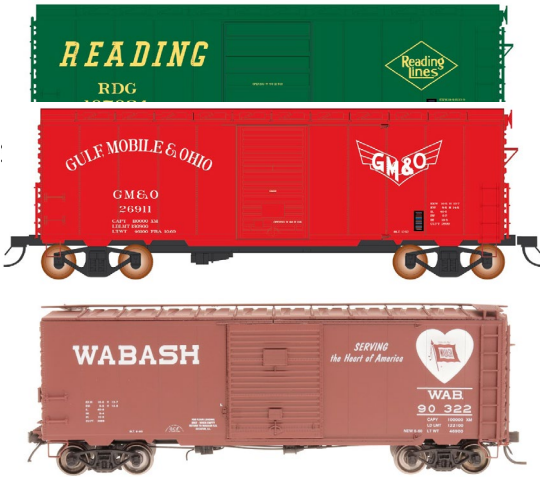

Cars equipped with 6-foot doors will be available for Gulf, Mobile & Ohio; Toledo, Peoria & Western; Colorado & Southern, and Reading.

Cars decorated for Detroit & Mackinac, Missouri Pacific, Illinois Central, Western Pacific, Rock Island DF2, and Wabash have

8-foot doors. Undecorated kits with a choice of either 6- or 8-foot doors are included in the release. The economy priced kits come with plastic wheelsets and no couplers. For additional information contact a dealer or visit intermountain-railway.com.

.....

**VIEW READER
COMMENTS**

click here



Kadee has scheduled the release of this Western Pacific boxcar in September. The ready-to-run model represents a

50-foot PS-1 built by Pullman-Standard in 1954. Like the prototype, Kadee's HO scale version has dual Youngstown doors covering an offset 15-foot opening.



Also due from Kadee in September is this PS-2 twin-bay covered hopper decorated for Chicago, Milwaukee, St. Paul & Pacific. The HO

scale Milwaukee Road model wears the original 1956 alkali-resisting light gray paint that was applied to the prototype. For additional information contact a dealer or visit kadee.com.



Menard's is selling an assembled model named Wally's Service Station. The HO scale structure features more than 20 LED lights including lighted domes on the gas pumps. The rooftop Shell sign revolves (a 4.5 volt

power source is sold separately). The model is 4.125 inches tall. It has a footprint of 8.25 x 5.25-inches. For additional information visit www.menards.com/main/home-decor/toys-recreation/train-stuff/ho-wallys-service-station/2795017/p-1506580368312-c-13318.htm.





New HO scale vehicles available from Oxford Diecast include a 1961 Chevrolet Impala convertible in Roman red with white trim, and a 1959 Pontiac Bonneville hardtop coupe painted in sunrise coral.



Additional 1:87 models recently released include a 1955 Buick Century decorated as NYC taxi, and cream-colored 1936 Buick Special convertible coupe. If your favorite hobby dealer does not carry Oxford Diecast models, the simplest way to purchase them in the US is on Amazon or eBay.

.....



Motrak Models has introduced a new laser cut camper body sized to fit on Classic Metal Works 1941 Chevy truck, which is included. The kit consists of laser-cut walls, outer shell, tarpaper material, random shake shingles, and windows and door. Accessories include a plastic smokestack, resin trash can, peace signage and signage

consists of laser-cut walls, outer shell, tarpaper material, random shake shingles, and windows and door. Accessories include a plastic smokestack, resin trash can, peace signage and signage

as a Mexican food truck. The Classic Metal Works truck comes pre-painted and the kit is ordered by which color truck is included. For more information see the Motrak Models website at motrakmodelsusa.com.

.....



Rapido Trains has announced that it is proceeding with new tooling for HO scale F9B and F7B units as produced for the Canadian market by GMD (General

Motors Diesel Division). According to Rapido's Jason Shron, the differences between the Canadian and US-built FB units are significant enough to require separate tooling.



Originally announced almost five years ago, the project to produce unique Canadian FB units all but died for lack of consumer interest. Last summer Rapido quietly released a statement cancelling

the project. Last month Shron happily announced that the response to the death notice was overwhelmingly positive and reservations have more than justified reviving the project. The F7B and F9B units will be available in ten liveries including two Canadian National schemes (1954 and stripes), two VIA schemes, two Canadian Pacific schemes (block and script), and two CP Rail schemes. For more information contact a dealer or visit rapidotrains.com.

.....





Resin Car Works is selling HO scale kits for AC&F Type 27, 8,000-gallon insulated tank cars. The resin model replicates a Warren Petroleum tank car from 1943, and several

Shippers' Car Line tankers from the late 1930s that were leased to Mathieson Alkali Works.



Photo courtesy Hawkins/Wider/Long collection
The limited-run craftsman-style kit includes accurate decals and a pair of appropriate Tahoe Model Works truck side frames.

Wheelsets and couplers are not included. For additional information visit resincarworks.com.

.....



ScaleTrains.com is planning another production run of GATC 4180 cu. ft. Airslide covered hoppers.

Availability is scheduled for this fall. Road names for the HO scale Rivet Counter series model will be BNSF, CSX, D&RGW, GACX, MKT, N&W, and WP. An undecorated version will also be available. Road name variations on the ScaleTrains.com models will include side column post and horizontal end braces, Morton or Apex metal running boards, ladder heights, gravity or pneumatic assisted outlet gates, roping eyes, and the location of the brake wheel. For additional information go to scaletrains.com.

.....

Tichy Train Group has published a cross reference that matches its own HO scale window stock numbers with the equivalent Grandt Line item. The cross reference can be viewed at www.tichytraingroup.com/Portals/0/Instructions/GRANDT_CROSS.pdf?ver=2018-05-30-150422-247.

.....



Train Life is selling kits for HO scale evaporative coolers commonly known as swamp coolers. The coolers come in a pack of four that includes two commercial size units (.56-inches

square, above left) and two residential size that measure approximately .39-inches square. The model swamp coolers are made of laser-etched material. The instructions include options for window or roof mounting. For additional information visit trainlife.com.

.....

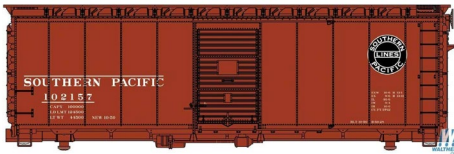

Walthers has announced a September release date for a new production run of 40-foot AAR 1948 boxcars. Significant differences from AAR's 1944

design include a diagonal panel roof and Improved Dreadnaught 4-4 ends with a truncated top rib. Additional spotting features on the Mainline series model include an Apex steel running board, 6-foot Youngstown sliding doors, and an Ajax brake wheel. The HO scale ready-to-run model comes with metal knuckle couplers, and Bettendorf trucks with 33-inch machined metal wheelsets. Road names will be Bangor & Aroostook, B&O, Great Northern, Penn Central, Wabash, and Southern Pacific.





Walthers has introduced four new Cornerstone structure kits that can be used individually or combined to create a complete brick making and shipping facility. The kits include brick kilns (left), and stacked bricks (right).



Completing the series of four brick yard kits is a corrugated storage building (left), and the main

production facility complete with a brick chimney (right). For more information contact a dealer or visit walthers.com.

.....

N SCALE PRODUCT NEWS



Athearn plans to release an N scale Trailer Train/TTX F-89F TOFC flat car with a 40-foot Fruehauf Z-Van trailer next May. Both brown and yellow TTX trailers will be available with a selection of 40-foot

trailers decorated for Santa Fe, Chicago & North Western, Conrail, M-K-T, Frisco, Union Pacific, and Erie-Lackawanna.



An N scale PS-2 2600 cu. ft. twin-bay covered hopper is also set for release in May. Features include an etched metal roof walk, factory-installed wire grab irons, and round or trough hatches depending on the practice of the railroad being modeled. Road names for the fully assembled model will be M-K-T, CSX, Conrail, Chicago & North Western, Rio Grande Chemical, and Grand Trunk Western. For additional information on Athearn products contact a dealer or visit athearn.com.

.....



Atlas reports that the next release of its N scale GP40 diesel locomotives will be dur-

ing the fourth quarter of 2018. In addition to Montana Rail Link, road names for the Master series model will be Detroit, Toledo & Ironton; Richmond, Fredericksburg & Potomac; HICX, Baltimore & Ohio, Milwaukee Road, Canadian National, New Jersey Transit, Southern Pacific, and Western Pacific. DC and DCC models with ESU LokSound will be available.

New N scale freight cars coming from Atlas include a Master series Thrall steel gondola. The car has an interior length of 52-foot 6-inches and a rated capacity of 2743 cu. ft. The ready-to-run model will be available decorated for Dakota, Minnesota &



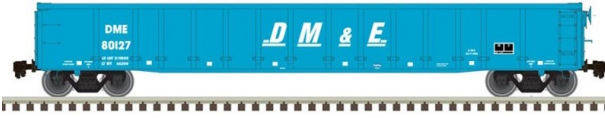

Eastern; Oregon Steel Mills, BNSF, CEFX (ex-CP), CRDX-Chicago

Freight, Norfolk Southern, and Union Pacific.



Also due for release during the fourth quarter is a Trainman series PS-2 twin-bay 2,003 cu. ft. covered hopper car. The model will come with either solid

bearing or roller bearing trucks as appropriate to the railroad being modeled. Road names will be Chessie System (B&O), CSX, Soo Line, Southern Pacific, Jersey Central, Missouri Pacific, Rock Island, and Burlington Northern.



Completing Atlas' fourth quarter production is another run of 60-foot heavyweight passenger

cars. Car types in this release will be baggage, combine, RPO, coach, and an observation car with an open deck.



The N scale models are based on C&NW and CNJ prototypes. Special features include diaphragms,

detailed interiors, and Accumate couplers. Road names will be Central of New Jersey, New York Central, Denver & Rio Grande, Milwaukee Road, Boston & Maine, and Grand Trunk Western.



For additional information on Atlas products contact a dealer or visit atlasrr.com.



able decorated for Union Pacific, Northern Central, Western & Atlantic, and Pennsylvania Lines.



In addition to Union Pacific, the four-wheel bobber caboose shown here is available decorated for Central Pacific, Santa Fe, and Pennsylvania Lines. For additional information contact a dealer or visit bachmanntrains.com.



Bowser has announced plans to release an N scale version of Pennsylvania class H21 quadruple-bay hopper cars. Delivery will be next March. The ready-to-

run model represents one of the largest classes of coal-carrying cars owned by PRR. Spotting features include four sawtooth discharge hoppers, 10 full side panels, and 11 side stakes with no visible sill.



Ten decorating schemes will be available including two Penn Central, one Virginian, and seven various PRR paint and



lettering arrangements. For more information contact a dealer or visit bowser-trains.com.

.....



Eastern Seaboard Models has released this photo of a pre-production sample of its new U.S. Railway Equipment

Corporation X72 boxcar.



Also under development at ESM is an ACF Type-27 class 103B 8,000 gallon acid tank car. The kit will include Micro-Trains #1015 couplers and

National B-1 trucks fitted with Atlas/BLMA metal wheelsets. Both of these new N scale models are expected to be available this summer. For more information visit esmc.com.

.....



Kato USA has released Amfleet I Phase VI cars to accompany its Siemens ACS-64 electric locomotives (See MRH News February 2018). Amtrak's initial fleet of pas-

senger cars was an assortment of aging equipment inherited from other railroads. The first new cars specifically designed and built for Amtrak were known as Amfleet I. The spotting features are doors on each end of the car side. Although subsequent designs have been introduced, Amfleet I cars are still in regular use on some of Amtrak's shorter routes. Kato's offering of N scale Amfleet

It includes a coach (above) and a café car. For additional information contact a dealer or visit katousa.com.

.....



Among the latest N scale models released by **Micro-Trains Line** is this Union Pacific paired-window coach. The model is based on a 78-foot heavyweight car built in the early 1920s that was later repainted in UP's postwar two-tone grey scheme.



This twin-bay covered hopper follows a prototype built by Gunderson in Mexico in 2013. Micro-Trains' N scale version features the CSX "boxcar" logo with the slogan "How tomorrow moves".



Built in 1956, the prototype of this 50-foot boxcar, with a pair of 8-foot Youngstown sliding doors on each side, subsequently had its running board removed and ladders shortened. Many N&W cars in this series were fitted with Evans Air Packs. The Micro-Trains N scale versions ride on Bettendorf trucks with solid bearings.



This 50-foot troop sleeper is the latest release in Micro-Trains on-going series of WWII-era military cars decorated with



morale-boosting posters. Like the prototype, this N scale model rides on Allied Full Cushion trucks. For additional information on Micro-Trains Line products contact a dealer or visit micro-trains.com.

NEW DECALS, SIGNS AND FINISHING PRODUCTS

Herald King Decals has updated its website, which offers over 1,000 waterslide decals for model railroad hobbyists. For more information visit heraldkingdecals.com.

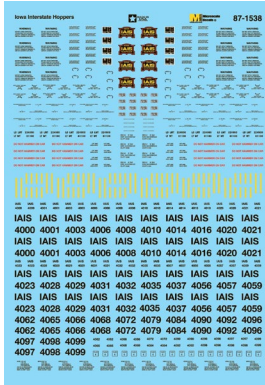

Microscale is selling waterslide decals for N and HO scale Iowa Interstate Hoppers. The sets includes 33 road numbers and eight IAIS logos. For additional information contact a dealer or visit microscale.com.

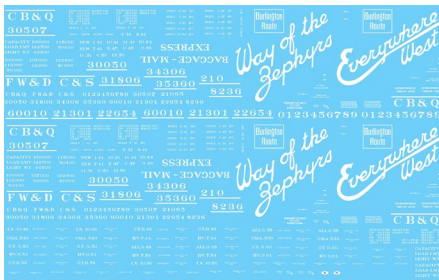

Speedwitch Media has released new prototypically accurate waterslide decals for GM&O GSC 53-foot 6-inch flat cars, CB&Q

XM-32 and -33 boxcars, and GN 1937-1942 double-sheathed boxcars. To order visit speedwitchmedia.com.

.....

Tichy Train Group has added 100 decals to its website. The complete collection of N, S, O, and HO scale lettering sets now totals more than 400 decals. To access the decal catalog go to tichytraingroup.com. On the home page click on SHOP, then SCALE, than DECALS.

.....

DISCLAIMER

The opinions expressed in this column are those of the writer and do not necessarily reflect the opinion of *Model Railroad Hobbyist* or its sponsors. Every effort is made to provide our readers with accurate and responsible news and information, however, neither *Model Railroad Hobbyist* or the writer of this column can be held responsible for any inaccuracies or typographical errors that may inadvertently appear in this column.



SEND US YOUR PRODUCT ANNOUNCEMENTS

If you are a hobby manufacturer with a product announcement, just [click here](#) and submit your announcement to us. Our web site and free magazine reach continues to grow, so get on board this new media train! ■

.....





BRIEFLY NOTED AT PRESS TIME ...

Atlas's production schedule for early 2019 includes RS-1 and Dash 8-40C/CW locomotives, a Trinity 5660 cu. ft. covered hopper, and a 50-foot 6-inch boxcar all in both N and HO scales. Coalveyor bathtub gondolas and 25K gallon tank cars are coming during the first quarter of 2019 in N, HO and O scales. N scale modelers can also look forward to a new run of multi-level passenger cars and an ALP-45DP locomotive ...

Bethlehem Car Works has kits for an HO scale Pullman 10-2 Sleeper plan 3584. BCW has also just released two Rutland steel coaches. These new models are based on Branchline kits with cast resin car sides produced by Tom Madden. Details at bethlehemcarworks.com ...

Downtown Deco is getting ready to release N scale kits for Lindsey's Grocery Store and Von Eerie's Family Restaurant ...

Tangent Scale Models has released another run of its HO scale ready-to-run model of a General Service Industries 60-foot flatcar with bulkheads. Road names include Seaboard Coast Line, Great Northern, Burlington Northern, Missouri Pacific and two versions of an Atlantic Coast Line car. Details are available at tangentscalemodels.com ...

Steel Valley Models is producing cast resin "Hopper Toppers" with Plano etched metal walkways. Used by Chessie/CSX, Conrail and ICG, the toppers are designed to fit Bowser and ConCor 100-ton 3-bay hoppers. They are available at www.facebook.com/Steel-Valley-Models-1823537481001708.

MRH will have complete details including graphics on all these new items in our next edition ...

Doug Junda and Bob Stears have announced that **The San Juan Model Co.** has been created out of the acquisition and merger of Grandt Line Products, The San Juan Car Co, San Juan Decals, American Limited Models and The Leadville Shops.

ExactRail has announced the Johnstown America AutoFlood II Hopper, the first time it has been released in N scale. The first run will be available in BNSF Brown, BNSF Green, CSXT, KGLX, NRLX, and UCEX, including 'On Track for the Cure and Military Veterans schemes. The model will include a coal load and feature body mounted Micro-Trains couplers & metal wheels. See exactrail.com for more information.

Atlas has announced that it is purchasing the N scale locomotive and rolling stock tooling from Walthers, sale does not include structures or electronics.

ScaleTrains.com has announced that it will be producing N scale models of the GE C39-8 and Pullman Standard 4785 covered hoppers in the Rivet Counter line.

Rapido Trains has announced several new products, in HO scale they announced the Alco RS-11, MLW RS-18, and Tempo Passenger car train box set, and in N scale the CN/BCR Dash 8-40CM locomotive. The order deadlines for the Royal Hudson and B36-7 have been extended to August 13th and September 17th respectively.



SELECTED EVENTS



Model Railroad Hobbyist | July 2018 | #101

JULY 2018



(Many events charge a fee. Check individual info website for details.)

CALIFORNIA, McCLELLAN (Greater Sacramento), July 11-15, National Summer Steamup of Small-Scale Live Steam, at Lions Gate Hotel, 3410 Westover Street. Info at steam-events.org.

ILLINOIS, COLLINSVILLE (Metro St. Louis), July 20-21, Railroad Prototype Modeler's Meet co-hosted by NMRA Gateway Division, John Golden, and Lonnie Bathurst, at Gateway Convention Center, One Gateway Drive. HQ at Double Tree Hotel adjacent to the convention center. Info at icg.home.mindspring.com/rpm/stlrpm.htm.

August 2018, by location

FLORIDA, THE VILLAGES, August 18-19, Summer Rail Expo Show & Sale, sponsored by the Villages Model Train Club, at Savannah Regional Recreation Center, 1545 Buena Vista Blvd. Info at thevillagesmodeltrainclub.com.

MARYLAND, ROCKVILLE, August 22-26, 50th O scale National Convention, co-sponsored by NMRA MER, Standard Gauge, Narrow Gauge, P48 and Traction modelers; at Rockville Hilton Hotel, 1750 Rockville Pike. Info at 2018oscalenational.com.

MISSOURI, KANSAS CITY, August 5-12, 2018, NMRA National Convention and National Train Show. Host hotel is Westin Kansas City at Crown Center. Info at kc2018.org.

NEW HAMPSHIRE, CONCORD, August 19, Model Railroad Show, sponsored by Concord MR Club, at Everett Arena, Loudon Road. Request info from Rich Fifield at ehfsaf@aol.com.

VIRGINIA, LYNCHBURG, August 11, Lynchburg Rail Day, sponsored by Blue Ridge Chapter, National Railway Historical Society, at Boonsboro Ruritan Club, 1065 Coffee Road. Info at www.blueridgenrhs.org/rail-day.

Future 2018, by location

CANADA, ONTARIO, TORONTO, September 29-30, The Greater Toronto Train Show, at Brampton Fairgrounds. Info at torontotrainshow.com.

CALIFORNIA, SAN DIEGO, September 12-16, NMRA/PSR Convention, sponsored by San Diego Division, Pacific Southwest Region at Marriott Courtyard Hotel Mission Valley, 8757 Rio San Diego Drive. Info at psrconvention.org/home/index.php.

ILLINOIS, LISLE, October 18-20, Railroad Prototype Modelers Conference Chicagoland, at Sheraton Hotel and Conference Center, 3000 Warrenville Road. Info at rpmconference.com.

INDIANA, SOUTH BEND, September 21-22, NMRA Michiana Division Education and Training Conference 2018 "Modeling like a PROtotype", at Aloft Hotel. Info at michiana-nmra.org.

MICHIGAN, EAST LANSING, November 11. Model Railroad Show & Sale, sponsored by Lansing MR Club, at Michigan State University Pavilion, 4301 Farm Lane. Info at lmrc.org/trainshow/index.shtml.



MICHIGAN, WYOMING (Greater Grand Rapids), October 13, Fall Train Show sponsored by Grand River Valley Railroad Club, at the Home School Building, 5625 Burlingame Avenue SW. Info at grvrrc.org.

MINNESOTA, BLOOMINGTON, September 5-8, 38th Annual National Narrow Gauge Convention at Double Tree by Hilton, 7800 Normandale Blvd. Info at www.nngc-2018.com.

NEW JERSEY, MAHWAH, September 13-16, NMRA Northeast Region Convention at Double Tree by Hilton, 180 route 17 South. Info at arielimited.org.

PENNSYLVANIA, EASTON, October 7, 42nd Annual Lehigh Valley Regional Train Show & Expo, co-sponsored by Railroad Historians of the Lehigh Valley and Lehigh Valley Chapter of the National Railroad Historical Society, at Charles Chrin Community Center, 4100 Green Pond Road. Info at www.lehigh-lines.org/uploads/9/1/4/5/91456028/2018_regional_train_show_and_expo_flyer.pdf.

Beyond 2018

UTAH, SALT LAKE CITY, July 7-13, 2019, NMRA National Convention and National Train Show. HQ hotel is Little America Hotel. Info at nmra2019slc.org.

MISSOURI, ST. LOUIS, July 12-18, 2020, NMRA National Convention and National Train Show. HQ hotel is Hilton St. Louis at the Ballpark. Info at gateway2020.org.

CALIFORNIA, SANTA CLARA, 2021, NMRA National Convention. ■



RATE THIS ARTICLE

Now available!

Issues 1-50 - Issues 51-99

Model Railroad Hobbyist magazine™

**Save
yourself
endless
hours of
downloading**

Send me 1-50

\$12

Shipping:

FREE in the US

Send me 51-99

\$12

50% off foreign

*Over 7,000
pages of
how-to
information
on model
railroading
on each
disk!*



• [INDEX](#)



SUBSCRIBE
(free)

• [TABLE OF CONTENTS](#)

[Accu-Lites](#)

[Archer Fine Transfers](#)

[Atlas Model Railroad Co.](#)

[Athearn](#)

[Bachmann](#)

[Backdrop Junction](#)

[Berrett Hill Trains](#)

[Black Cat Publishing](#)

[Blair Line](#)

[Bowser](#)

[Caboose](#)

[Canyon Creek Scenics](#)

[Coastmans Scenic Products](#)

[Coffman Graphics](#)

[Crow River Products](#)

[Daniel Cortopassi Productions](#)

[Digitrax \(2 page spread\)](#)

[El Dorado 3rd PlanIt](#)

[ESU LokSound](#)

[Fast Tracks](#)

[Fast Tracks \(Scale Lumber\)](#)

[Fine Scale Miniatures](#)

[Great Decals](#)

[HO Diesel Supply](#)

[Iowa Scaled Engineering \(ISE\)](#)

[ITLA Scale Models](#)

[Ken Patterson.com](#)

[Lights 4 Models](#)

[Litchfield Station](#)

[Logic Rail Technologies](#)

[Main Street Heritage Models](#)

[Masterpiece Modules](#)

[Micro-Trains Line](#)

[Model Railroad Control Systems](#)

[Monashee Laser Engineering](#)

[Mountain Subdivision Hobbies](#)

[MRH Store \(1\)](#)

[MRH Store \(2\)](#)

[MRH Store \(3\)](#)

[MRH Store \(4\)](#)

[MRH Store \(5\)](#)

[MRH Store \(6\)](#)

[National Train Show \(Kansas City\)](#)

[NCE \(2 page spread\)](#)

[North American Railcar Co.](#)

[Pre-Size Model Specialities](#)

[Precision Design Co.](#)

[Rapido \(1\)](#)

[Rapido \(2\)](#)

[Ring Engineering \(1\)](#)

[Ring Engineering \(2\)](#)

[Scale Trains](#)

[Mike & Scotty Live](#)

[Soundtraxx \(Blackstone\)](#)

[Southern Digital](#)

[Streamlined Backshop Services](#)

[TAM Valley Depot](#)

[Tony's Train Exchange](#)

[TrainMasters TV \(1\)](#)

[TrainMasters TV \(2\)](#)

[TrainMasters TV \(3\)](#)

[Walthers](#)

[Westerfield Models](#)

[Yankee Dabbler](#)

[Yarmouth Model Works](#)

DONATE*

Donations help pay contributors for more excellent articles and videos, and help keep MRH free to all your fellow modelers.

* Donations for hobby publications are not tax-deductible.

Clickable "other" index

[Other - Contents](#)

[Other - Cover](#)

[Other - Derailments](#)

[Other - Hobby Marketplace](#)

[Other - MRH Sponsors](#)

DOWNLOAD ISSUE



DOWNLOAD PORTRAIT



DOWNLOAD LANDSCAPE

• [INDEX](#)



SUBSCRIBE
(free)

• [TABLE OF CONTENTS](#)

REVERSE RUNNING

commentary



Model Railroad Hobbyist | July 2018 | #101

JOE BRUGGER: TIME TO PUT THE
KEYBOARD DOWN AND BACK AWAY?

★★★★★
RATE THIS ARTICLE



TODAY, I READ THE SADDEST THING I HAVE SEEN IN A long, long time. Certainly, the saddest to appear in a hobby magazine.

“Didn’t have time to read the article.”

The guy who wrote it (who will not be identified) is an accomplished modeler. Like many of us, he spends a fair amount of time on the internet following model railroad topics and makes many good contributions. He asks a lot of good questions.

And, like many of us, that may take up a lot of his hobby time.

▶ **STEPPING OUTSIDE THE BOX WITH A CONTRARY VIEW**

• [INDEX](#)

• [TABLE OF CONTENTS](#)

Want to know about all the latest releases? Check out the “News and Events” in *Model Railroad Hobbyist*. Add your favorite manufacturers to your Facebook feed. Want to check out the air reservoir size on a Union Pacific small Consolidation? Google it.

Whoops. Can't find out about those air reservoirs? Too bad. Download a couple of pictures and guess. No pictures? No plan drawings? Move along. There are plenty of other unfinished projects on the shelf.

Do you see what happens here?

First, we default to finding the fast and easy solution.

Second, our hobby universe shrinks to whatever is available online – there are plenty of maps and photos and people who share their discoveries, but not everything has been researched, scanned, and posted. Frankly, for the modeler who wants to go beyond a primary level of prototype modeling, there are big gaps in the info available. Some information – *gasp* – is only available in printed magazines and books. Some can only be unearthed by searching through dusty files or talking to people.

Third, we end up in a circle of modeling each other's projects. There isn't a good avenue for discovering new information and modeling techniques.

Fourth, the whole process takes place while we're sitting in our chair and gazing out of the window. That's not conducive to good mental and social health.

“Didn't have time.”

What is a hobby about, other than setting aside some time in our daily routine for a little relaxation? Is model railroading now a race to build the biggest railroad? Is it now a competitive sport? Is someone, somewhere keeping score? Is it simply reading and talking about train stuff on the Web? Are we really modelers if we are content to go only where the markets lead us?

If we are interested in railroading, and if we are interested in modeling, shouldn't we use some of our limited hobby time to look for information? Shouldn't we take time to play around with techniques that will bring our model creations closer to reality? Shouldn't we stretch ourselves a little by some hands-on exploration?



DERAILMENTS



RATE THIS ARTICLE

Model Railroad Hobbyist | July 2018 | #101



Five ALCO's working hard

This Delaware Lackawanna train works the freight cars with so much pull the dispatcher in Tower 60 said over the radio that she could feel the force from there! ■

**VIEW READER
COMMENTS**

click here

► **BIZARRE FACTS AND HUMOR (SUPPOSEDLY)**

• [INDEX](#)

• [TABLE OF CONTENTS](#)

COMING NEXT MONTH ...



Ken McCorry's Conrail Buffalo Division ...



Running trains with the new ProtoThrottle ...



Modeling an ornate downtown station ...

... and lots more coming
in the August MRH!

• [INDEX](#)



SUBSCRIBE
(free)

• [TABLE OF CONTENTS](#)