

Model Railroad Hobbyist magazine™

The model-trains-video.com mediaZine

Third Quarter 2009

EMBEDDED Edition

Using servos for turnout control

Upgrading the Kato covered hopper



Build your
own... **Deluxe track
cleaning slider car**

FIRST LOOK: Sergeant Couplers

Modeling telephone poles

ROLLIN' IN FAST!



HO Scale Model Pictured

Norfolk-Southern TOPGON 2nd Run!

Our first run **SOLD OUT** before it arrived! But don't worry...we're bringing you two new paint variations in the **NEW G-86R** car class, 24 new numbers, and a new variation with yellow striping! Don't miss the order deadline... **ORDER TODAY!**

HO Scale Features:

- 100% Ready-To-Run
- Separate Wire Grabs/Cut Levers
- Accurately Painted & Printed
- Installed Internal Bracing
- Kadee #58 Scale Couplers
- Etched-Metal Brake Platform
- 2nd Run - 24 New Numbers!

Pre-Order Deadline: August 15 N \$18.95
Expected Delivery: November HO \$27.95

G-86R w/ TopGon Logo

HO #50037 - 50048 N #10037 - 10048



G-86R w/ TopGon Logo & Yellow Striping

HO #50049 - 50060 N #10049 - 10060



You've seen them in real life...
 Now you can put them on your layout!

The PODS moving and storage containers have been a highly visible fixture of life in North America for over a decade. BLMA Models is proud to release these fine-scale, officially licensed miniature replicas!

HO SCALE #4115
 \$9.45

NS SCALE #615
 2 for \$12.95



Officially Licensed by

VISIT OUR WEBSITE AND WATCH THE VIDEOS



www.BLMAModels.com

HAVE YOU TRIED OUR NEW CONSIST GENERATOR YET?


IT'S A GREAT WAY TO PLAY WITH YOUR TRAINS, EVEN WHEN YOU'RE NOWHERE NEAR YOUR TRAINS.

CAN'T WAIT? CLICK ON THE TRAIN BELOW TO PLAY WITH IT.



A part of our free My Railroad suite of tools and utilities. It's cool and will make girls like you.



 Click to Visit



This tragedy could of been prevented...



FAST TRACKS

www.fast-tracks.net

2009 NTS - Booths 127, 128 & 129

Feature Articles

26 **Alcos in the Alcove**

Byron Henderson starts with a simple interest in Alco locos and builds it out into a great concept for a switching layout in a small space.

HO

29 **R/C Servos for Model Railroading**

Model railroader and servo expert Duncan McRee demonstrates how to use inexpensive high-tech servos to operate turnouts and move semaphore signal arms in this in-depth feature article.

Any Scale

51 **Modeling Telephone Poles** *by Bob Grech*

Expert modeler Bob Grech presents his step-by-step techniques for making some very realistic telephone poles.

HO

56 **Deluxe Track Cleaning Slider Car**

The masonite slider track cleaning car idea has been around for decades – modeler Mike Ruby shows how to take that basic idea and “put it on steroids”.

Any Scale

62 **Upgrading the Kato Covered Hopper**

Take your basic Kato covered hopper and upgrade it with Mont’s prototype detailing and weathering techniques to transform it into a more accurate model of the real thing.

HO

70 **FIRST LOOK: Sergeant Couplers**

Jeff Shultz and Jason Baakko take an in-depth look at these exact scale HO couplers that actually operate!

HO



Photo by Duncan McRee

Editorials & Columns

11 PUBLISHERS EDITORIAL: Hobby publication erosion

Since the 1980s the circulation of model railroading magazines has been dropping. Our publisher comments on what that may tell us about the future of the hobby. *by Joe Fugate*

77 THE LITE AND NARROW: Plausible freight car design

Lew Matt delves into the process of freelance freight car design, and includes some generic car drawings to use as a basis for making up your own believable narrow gage or shortline freight cars. *by Lew Matt*

87 UP THE CREEK: Geology lessons

Charlie Comstock goes below the ground level on his Bear Creek layout to detail some of his benchwork techniques, which includes a video of his benchwork design done in 3rd PlanIt. *by Charlie Comstock*

92 COMME-N-TARY: Creating a realistic roster

John Drye discusses the process of building a prototypically accurate roster for his mid-50s era Pennsylvania Railroad. The mix of road names he needs may surprise you! *by John Drye*

101 PARALLEL LINES: How I finish turnouts

Trackwork columnist Tim Warris illustrates how he ballasts, paints and weathers a turnout to look more like real trackwork. Learn great tips and hints from a trackwork master! *by Tim Warris*

105 THE NEW MEDIA: Goodbye newbie status

When someone told Ryan Anderson he was no longer a hobby newbie, this lead Ryan to search the web for guidelines on model railroading skill levels – his findings may surprise you! *by Ryan Andersen*

118 REVERSE RUNNING: The death of scratchbuilding

Many old-timers in the hobby are bemoaning how the ready-to-run trend is killing the need for hobby craftsmanship. Joe Fugate wonders: is scratchbuilding is really dead? *by Joe Fugate*



18 July Model Railroading News and Events

July Model Railroad Hobbyist newsletter – see the hobby scuttlebutt you're missing each month in our monthly newsletter!

Any scale

108 Jack Burgess' Yosemite Valley RR

Our layouts editor visits Jack Burgess' *by Charlie Comstock*
Yosemite Valley Railroad for some exciting new updates on this ultra-accurate layout modeling August 1939.

HO

Bonus Features

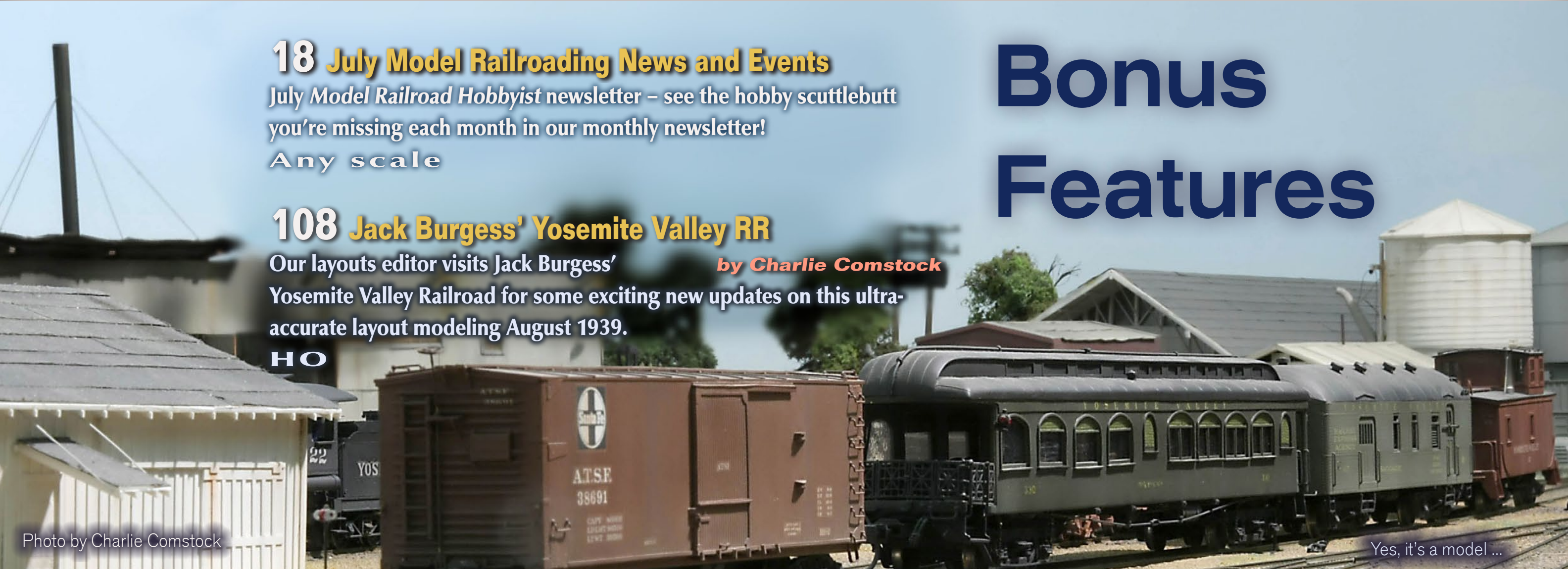


Photo by Charlie Comstock

Yes, it's a model ...



ACCU-LITES, inc

- DCC Specialists
- Digitrax-NCE-LENZ-Soundtraxx
- TCS-QSI Solutions-RR CirKits

**We are an Authorized Walthers Dealer
We offer 20% off the MSRP on ALL Walthers Catalog Items!**

Watch our website for our monthly specials!

CLICK TO LEARN MORE: <http://www.acculites.com>



DECALPRO[®]fx

Make Your Own **REAL** "Dry Transfer" Graphics In 8 minutes!



Use your laser printer (or copier) to turn black toner white or any of 12 metallic colors & full-color from any color laser or copier!

Pulsar
PROFESSIONAL fx

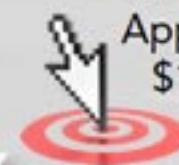
21 Carriage Drive, Crawfordville, FL 32327-2496
Phone: (850) 926-2009 eMail: mail@pulsarprofx.com

www.DecalProFX.com

Powerful Capability for
the Serious Hobbyist



Complete
Starter Kit &
Applicator
\$159.⁹⁹



Model Railroad Hobbyist magazine



Front Cover: Microelectronics and robotics hobbyists have been doing creative animation with servos for decades – it's time model railroading turnout and signal animation comes into the 21st century. Read all about it in this issue.

ISSN Pending

Editorial Staff
Joe D. Fugate, Publisher
Charlie Comstock, Layouts and media editor

Columnists
Ryan Andersen, New media
Richard Bale, News and events
John Drye, N scale
Lew Matt, Narrow gage and shortlines
Marty McGuirk, Prototype modeling
Tim Warris, Trackwork

Special Correspondents
Jim Duncan, Layouts and operations
Byron Henderson, Layouts and track planning

Production
Patty Fugate, pasteup and layout
Joe Brugger, copy editing
Mike Dodd, copy editing

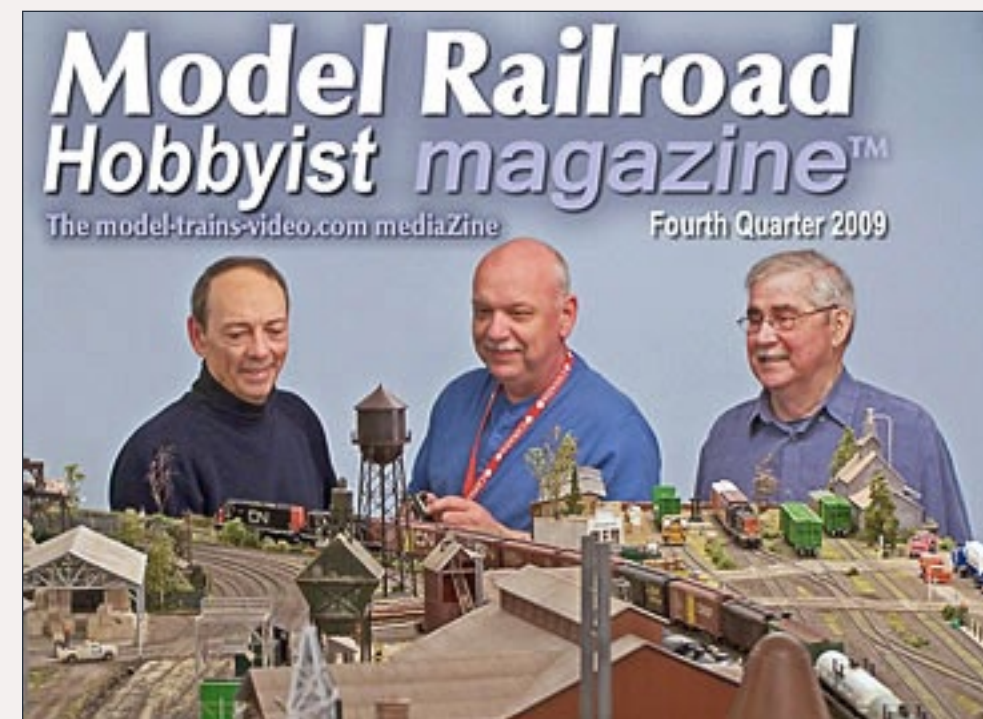
Technical Assistant
Jeff Shultz

Advertising Account Manager
Les Halmos

Coming next issue

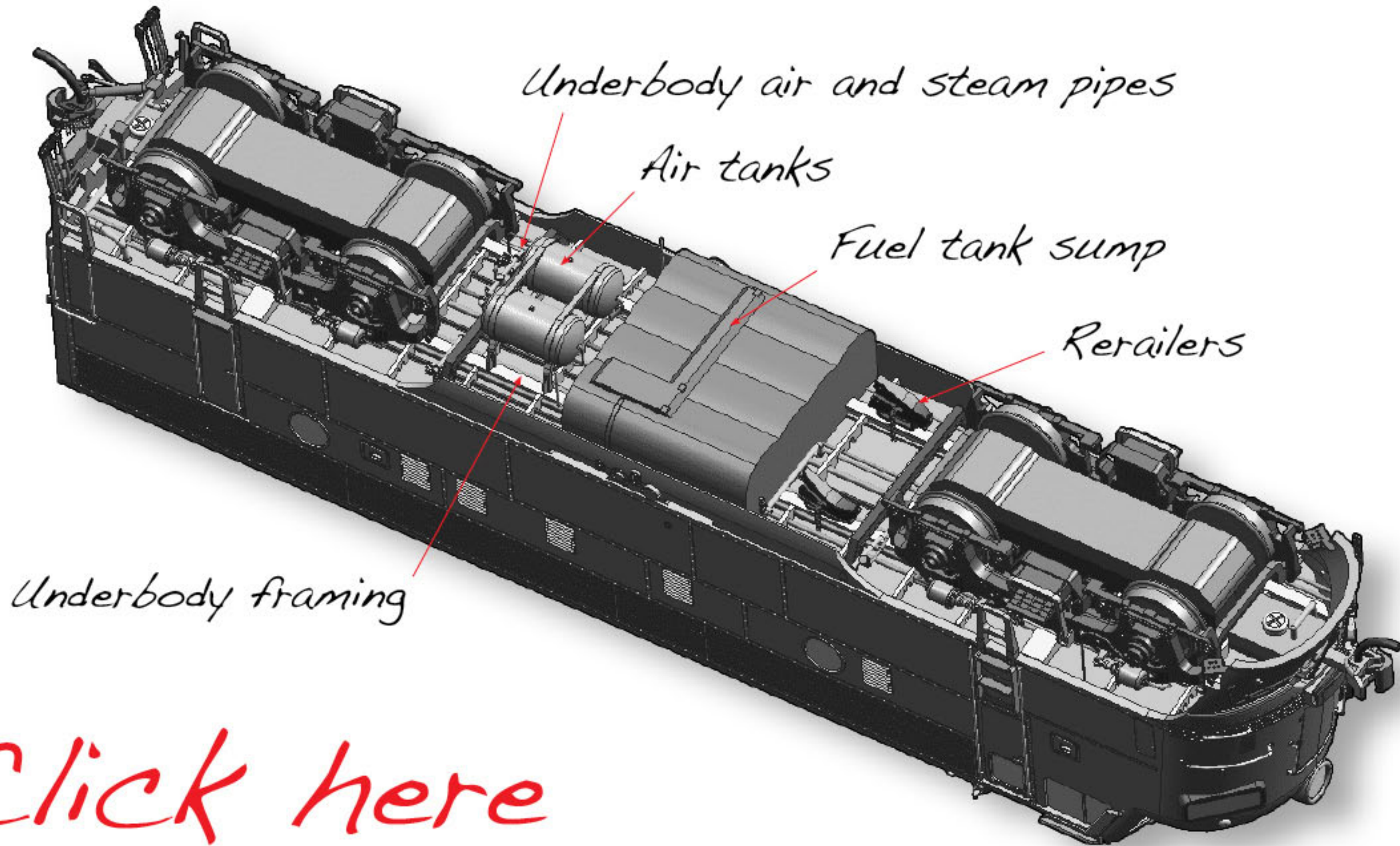
- New series: build an operating turntable and roundhouse
- CSX SD38 painting
- Operating switch stands
- Better windows for structures
- Final installment of the 3rd PlanIt series
- Another Byron Henderson track plan
- Our regular columns

... and lots more!



For the love of model trains

The Most Detailed F-Unit Model on the Planet.



Click here
for more info. 

Sounds of Perfection!

Put the "Quantum Revolution-A" on your list!
Thousands sold to our happy users!



- 2 Amps, HO/S Scale
- 6 Lite Functions, 28 Total
- Advanced Analog™ DC with Quantum Engineer
- System & Specific Volume Controls
- Sound-of-Power™ Sounds of locos under load
- Pro-Power™ Reduces shorts/opens
- Regulated Throttle Control™ / BEMF (Super Smooth)
- Quantum Air Brakes
- Stat Chat™ Verbal Feedback
- Magnetic Wand™ Reset and Volume
- Quantum Doppler™ Effect
- Quantum Download - Edit and Install Sounds
- New Sound Effects
- Co-Processors: 16+8 Bits
- List \$109.95



QSI Solutions.com • (800) 671-0641

The only manufacturer to offer a two year unconditional warranty!

PUBLISHER'S EDITORIAL: Hobby publication erosion?

Musings from the MRH founder

About the Publisher




Joe Fugate is the featured expert in many Model-Trains-Video.com videos, and he's also the founder and publisher of **Model Railroad Hobbyist Magazine**.

To learn more about Joe, [click here](#).



Reader feedback!

CLICK HERE for reader comments on this article ... 

Model railroading magazine circulation has continued to drop in the last 20 years ...

Last issue I discussed some indicators that the hobby is doing okay, especially in light of recent trends like the growth in holiday train set sales.

I also pointed out that the newest Generation Y population now exceeds the legendary Baby Boomers – which means there's a huge market that will be coming of age in the next 20 years.

But what about hobby publishing? Isn't it true that the circulation of magazines like *Model Railroader* peaked in the 1980s and has been in decline ever since? Isn't this a strong indicator that the model railroading population is shrinking?

Maybe or maybe not – you need factor in *all* the considerations around why this shrinkage has been occurring.

Since the advent of inexpensive desktop publishing in the late 1980s, we've seen the rise of numerous niche publications in model railroading – Kalmbach's *Garden Railroading* and *Classic Toy Trains* being prime examples.

Then there's the *Narrow Gauge and Shortline Gazette*, which is published by Benchmark Publishing.

Add to that the scale-specific magazines for N scale (count them *two* different magazines), Z scale, O scale, and S scale. None of these magazines existed in the 1980s when *Model Railroader's* circulation peaked.

If you add up the circulation of all these niche magazines, then assume a 30% overlap of the same people getting multiple magazines, you far exceed the circulation of *Model Railroader* at its peak.

While some cite the decline of hobby magazine circulation as a sure sign the *hobby population* is in decline, you need to account for all the niche publications that siphon off readers – *and* you also need to consider the effect of the internet.

In the 1980s, the print magazines were the *only way* for the masses to find out what other people were doing in the hobby. With the rise of the internet in the 1990s, that's no longer true.

In fact, I suspect the internet contributed to the demise of the second-tier model railroading magazines: *Main-line Modeler*, *Model Railroading Magazine*, and *Railmodel Journal*. There's just too much helpful info available online for free to make it necessary to spend a good chunk of your monthly

hobby budget getting all these “extra” magazines.

Into this vacuum comes *Model Railroad Hobbyist* – the **forever free** internet magazine that's hobby-vendor sponsored. By being free, *Model Railroad Hobbyist* has a virtually boundless potential.

Anyone on the planet who has an internet connection and is interested in model railroading can potentially download and read MRH *without* limitation.

Once word has spread that MRH exists, how large will the “saturation” circulation be? Will *that* be an indicator of how large the hobby *really is* now?

Time will tell if the hobby really is shrinking or not. As I said last issue, I believe the hobby's not the fad it once was in the 1950s and 60s, but it still has a strong following around the globe.

I believe the hobby has a bright future ahead of it well into the 21st century. We modelers can now connect and share knowledge quickly with *any other modeler on the planet* via the internet.

And if that isn't exciting, I don't know what is!

Notes from the MRH Staff

Bulls-eye, magazine growth, premium content, and more



When you see the **Bulls Eye logo** on ads, that means “click me”. It tells you where to click on an advertisement to learn more about the vendor’s products.

Since we’re ad-supported, *the more you click on ads*, the more advertisers are willing to place ads with us. If you like MRH being free and want to ensure we keep coming to you free, then every click on a bulls-eye logo is like money in the bank to us!

Issue size growth

You may notice that Marty McGuirk’s prototype modeling column isn’t in this issue. Also, the 3rd PlanIt part 3 article isn’t in this issue as planned. So what happened?

Issue 3 kept growing and growing, with Duncan McRee’s servo article coming out at a whopping 22 pages, we kept finding other goodies to include in the other articles, and the Sergeant Couplers First Look piece grew into a full-fledged feature-length article ...

continued on page 13 →

Your Premier Highball Auction Site

UP bids.net

ONLINE AUCTION SOLD

For all of your Railroad needs, whether you are looking to buy or sell, our auction is the best option.

**Free Listings
Super Low seller fees**

Come check us out!!!!

Everything you need to know about model building in one great How-To resource...the Micro-Mark catalog!

More than 2,750 name-brand and hard-to-find tools, trains and supplies, plus tips, techniques and more...all designed to help you complete your hobby projects in less time with more satisfying, professional results!



Micro-Mark
THE SMALL TOOL SPECIALISTS

Track Tools page 82

Free Catalog!
Click here and enter code BA3

1-800-225-1066
Shop On-Line: www.micromark.com

Micro-Mark
SMALL TOOL SPECIALISTS

Make Your Own Custom Decals at Home page 54

NEW!
Spiking Pliers page 90

1-800-225-1066
www.micromark.com

\$4

Micro-Mark®

Berkeley Heights, New Jersey 07922
1-800-225-1066

As an electronic publication, we're not as hampered by page count like a physical print publication, tis true.

But we can't keep adding pages indefinitely and still make our publication deadlines either. Our goal with each issue is at least 100 pages, with 120 pages an ideal maximum.

We're also adding advertisers each issue, so the page count will tend to grow slowly as we strive to maintain a high content-to-ads ratio. Issue 3, however, was getting out of hand at 150+ pages, so we had to cut somewhere.

Marty offered to take a brief siesta for one issue, so we took him up on the offer. Don't worry, he will be back in issue 4. Mont Switzer's article in this issue somewhat fills in for Marty's column as a nice prototype modeling-based piece.

The other casualty in issue 3 is the third and final installment of the 3rd PlanIt series. It makes editorial sense to skip one issue with this series to give us more room to vary the issue content from a steady stream of computer-based track planning articles.

For those of you following this series, don't worry, the final installment of the 3rd PlanIt piece will be in issue 4 – Ryan Boudreaux covers some great topics, complete with 14 (count them, 14) how-to video clips demonstrating various techniques with this amazing software.

Remember our reader survey!

If you haven't yet voted in our [reader survey](#), then please do so. Advertisers want to know who's reading *Model Railroad Hobbyist*, so by voting you get a voice in attracting the advertisers who have the products you are most interested in.

We still need another 1,000 responses to get the statistical confidence levels that will give the survey the most relevance when presenting it to hobby vendors.

Download the next issue right away, or miss out!

Good circulation numbers help *Model Railroad Hobbyist* succeed. If modelers take their sweet time before downloading an issue, that hurts circulation and makes us less inviting to hobby vendors.

Issue 2's download numbers are off by at least 25% – and from some responses we've gotten when checking around, we believe more than a few of you still haven't gotten around to downloading the issue yet.

To encourage all you procrastinators to download each issue right away, we're giving you special incentives. You [get access to extra premium content](#) only if you download each issue within 30 days of its release.

The early download goodies available via special links in issue 3 include:

continued on page 14 →

LISTEN UP!

SPONSORED BY:
THE MODEL RAILROAD
HOBBYIST MAGAZINE

The Scotty Mason Show

THE FIRST INTERNET MODEL RAILROADING PODCAST

*Get the Latest Model Railroading
News, Tips, Reviews & Opinions
From These Knuckleheads.*

Scotty Mason

Jimmy Deignan

Dave Frary

Doug Foscale

Available here or on iTunes

www.modelrailroadpodcast.com

[Visit Scotty Mason podcast site](#)

[Tell a friend ...](#)

[Contents](#)

[Index](#)



S T A T I O N

Our Team



Making DCC Fun!

 www.Mr-DCC.com

623-298-7355

- Handy-dandy **Universal Modeling Measurements Chart** for O-Z scale (definitely a *miss-this-and-you'll-be-sorry* extra)
- Additional DVD-quality rich media that's not in the magazine
- Special money-saving advertiser coupon codes (only good until August 1st).

Regarding the *Universal Modeling Measurements Chart*, let's say I wanted to see how large a 2-1/2" pipe should be in HO. A glance at this chart tells me:

- 2-1/2" in HO = 0.029" or 0.737 mm.
- The proper drill size is #69 (ANSI) or .75 (ISO)
- The closest approximate decimal drill size is 1/32

- The matching wire gauge is #21
- The nearest screw size is 00-90 (just over 3" in HO)
- The 00-90 tap drill size is #63/.95
- The 00-90 clearance drill size is #55/1.35

All from a quick reference to this handy chart – so don't wait to download an issue or you'll miss out!

Free hobby shop listing section on our web site!

We've opened a new hobby shop listings section on the MRH web site – shops can list with us **completely free**.

We're getting an average of 15,000 unique visitors to our web site every month and we've had over a million

continued on page 15 →

Issue 3 Premium Extras!

Free for the first 30 days after issue release
(After August 2, 2009, cost is \$2 to access)

- **Universal Modeling Measurements Chart (O, S, HO, N, Z)**
- **DVD-quality versions of this issue's videos**
- **Special money-saving advertiser coupon codes**



Click here to access

page views since we launched last summer!

We hope in time to have the most complete model railroad hobby shop listing on the web. If your shop's not listed with us, remind them we're free.

Just tell your local hobby shop to google: *free model railroad magazine*, take the top entry in the search list and then select: hobby shops! ■

When you see this symbol, it means:



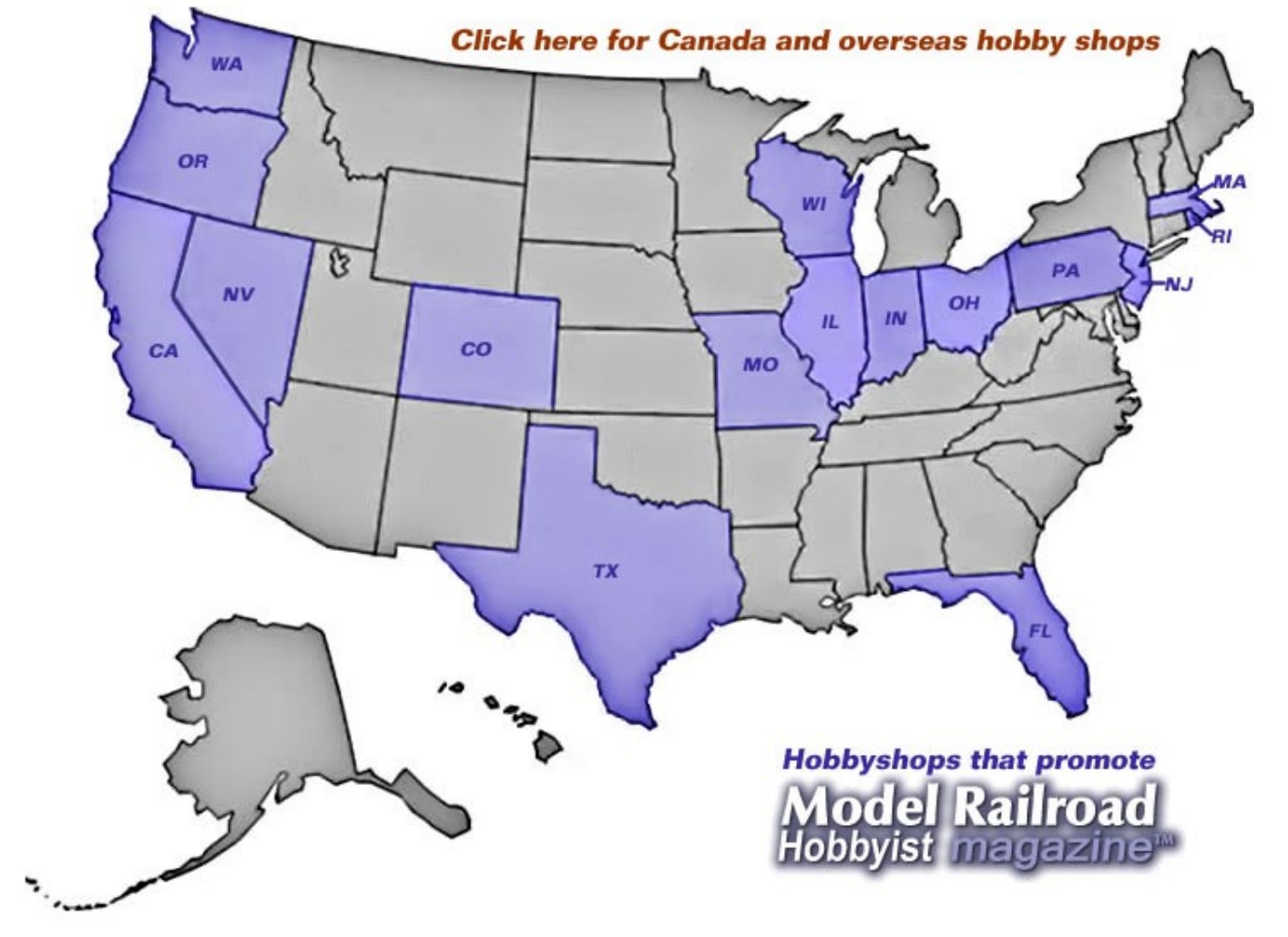
"Click here to learn more!"

Every click tells advertisers an ad in MRH is a wise investment ...

Hobby Shops

Hobby shops that support Model Railroad Hobbyist magazine - click on a State for details.

If you would like your hobby shop added to this list, just [click here](#). We also list [shops outside the USA](#).



The US map on the Model Railroad Hobbyist web site is slowly filling up with hobby shops who want their free shop listing on our web site.

Model Railroad Tips

100% FREE!
ONLINE & PDF ARTICLES
CLICK HERE TO LEARN MORE...



VERNONIA
PO Box 207
Vernonia, Oregon 97064-0207

NORTHERN

DCC Conversions at reasonable rates.

Need a custom circuit for model building lighting or unique feature on your model railroad?

Contact Vernonia Northern with your specifications.

PO Box 207
Vernonia, Oregon 97064-0207

www.vernonianorthern.com



V&O 41' Gondola
in HO



First time ever V&O Gondola. Highly detailed Accurail model available as kit or RTR. Oxide red or black. 3 numbers each color.

Kit \$17/RTR \$23 Postpaid
All 6 Kit \$80/RTR \$108 PP

Website or check/MO only to:
Division 3, MCR
6493 Anvil Dr
Waynesville OH 45068



Your Premier Highball Auction Site

For all of your Railroad needs, whether you are looking to buy or sell, our auction is the best option.

Free Listings • Super Low seller fees
Come check us out!!!!

UP
bids.net

ONLINE AUCTION
SOLD





Quality



Precision

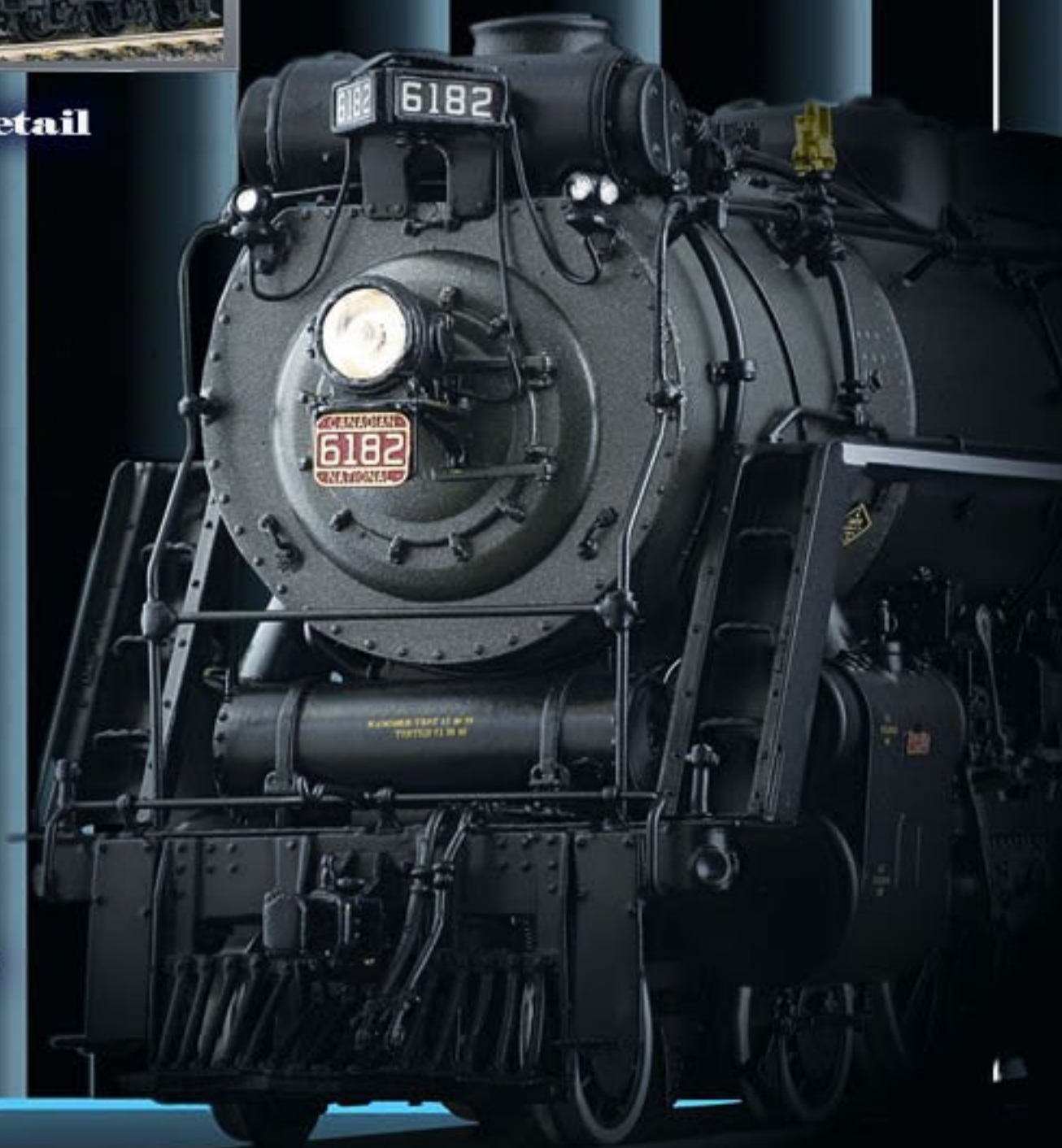


Detail

Don't just buy brass *INVEST IN BRASS*

You can trust your investment
when you purchase a model
from Division Point

Canadian National Railway
U-2-f 4-8-4
2008 Release - Sold Out



 **Division Point**
www.DivisionPoint.com orders@DivisionPoint.com
Ph. 303-499-5909

Visit our website or contact your favorite
Division Point Dealer today to see our full product line

Model Railroad Hobbyist's First annual reader online survey!



**Help us get a better idea of who's
actually reading MRH ...**

Want to help Model Railroad Hobbyist succeed in getting more hobby advertisers? Participate in our online anonymous reader survey! Armed with *actual reader demographics* when speaking with advertisers, we can more easily show hobby vendors why they *need* to be placing ads in MRH.

MRH First Annual Reader Survey

Who's reading MRH?



We're conducting a survey of our readers so that we can get a better idea of who our readers are, and have demographics to give our advertisers. Please answer the questions below - all results are totally anonymous.

On each question, pick your choice(s) and then click "Cast your vote". Repeat this process with each question.

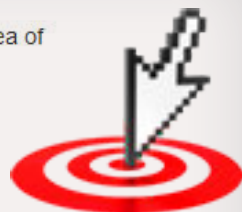
CLICK HERE to take the survey

Online Surveys & Market Research

What's your age?

Please select 1 answer.

- Under 20
- 20-29
- 30-39



CRAFTSMAN STRUCTURE SHOW v 3.0 2009

**IMPROVED
& UPGRADED!**

"They pulled off the best show I've ever attended, and I've been to hundreds."
Dave Frary

"I have to say this was the finest show I've ever done."
Bob Van Gelder, South River Modelworks

MODEL BY DAVE REVELIA

NOVEMBER 12th, 13th & 14th 2009

**HOLIDAY INN
MANSFIELD, MA**

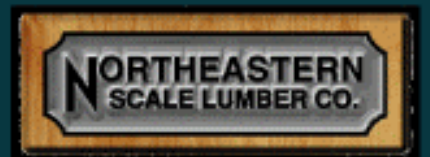
**THE ONLY SHOW EXCLUSIVELY FOR SCALE
MODEL STRUCTURE BUILDERS AND COLLECTORS.
NEW! CSS PREMIUM WORKSHOPS NOV.11TH
HANDS ON CLINICS IN SMALL GROUPS**

**ATTEND CLINICS GIVEN BY THE BEST KNOWN MODELERS
DAVE REVELIA - BRETT GALANT - BRIAN NOLAN
RUSS GREENE - DAVE FRARY - MIKE TYLICK
DOUG FOSCALE - SCOTT MASON - BOB VAN GELDER & MORE**

BROUGHT TO YOU BY:

**CRAFTSMANKITS.COM
FOSLIMITED.COM
SCOTTYMASON.COM**

SPONSORED BY:



**& THE MODEL RAILROAD
HOBBYIST MAGAZINE**



REGISTER AT

WWW.CSS09.COM

Model Railroad Hobbyist newsletter™

July 2009



Newsletter feedback!

CLICK HERE for reader comments on newsletter ...

The Old Yardmaster



News and views from up and down the line...

Since our report last month on Athearn's future plans for the SD70ACe / SD70M-2 tooling recently acquired from Tower 55, we've learned that the dies will be reworked to provide a wide variety of road-specific details in the Genesis version of the HO scale diesel.

Variables will include such goodies as alternate placement of fuel fill and fuel gauges, a choice of anticlimbers, different rear sand filler locations, different inverter cabinet panels, both high and low headlights, different dynamic brake louver panels and both early and late versions of jacking pads.

Look for a list of road names on the initial run to be announced later this year with delivery no sooner than the first quarter of 2010.

The C&NW Historical Society has contracted with Accurail to produce a seldom-seen Fort Dodge Des Moines & Southern non-interchange hopper car. In 1959 FDDM&S purchased eight former Louisville & Nashville 50-ton 2-bay hopper cars for gravel and ballast service. The repainted FDDM&S cars were stenciled "Company Material Only." Offered in two car numbers, the HO scale hoppers are available direct from the historical society store at www.CNWHs.org

The Coach Yard, importer of HO scale brass passenger equipment, has clarified which items on their extensive production list are expected to arrive from their Korean builder during the second half of 2009.

The items include heavyweight Southern Pacific Daylight 8-car sets with repaired power trucks, due in late June; individual heavyweight SP cars with extra trucks due in mid-July; Baltimore & Ohio EA/SF E1 diesels expected by the end of August; Santa Fe San Francisco Chief cars due near the end of October and Baltimore & Ohio Capitol Limited cars due in December.

Deluxe Innovations is quoting 4th quarter delivery for a 40-foot Missouri Pacific box car displaying the road's large white buzz-saw herald. The N scale model will be offered in six different car numbers. Also due this fall is a Canadian/Canadien National deep-rib woodchip gondola decorated in CN's wet noodle lettering style. Ten different car numbers will be offered.

As the result of considerable positive feedback received for an HO scale diorama Randy Pepprock cobbled together from a variety of old castings, Randy, who owns Downtown Deco, has decided to market a limited number of the dioramas in kit form. Since his original idea centered on a gentleman's club and a funeral home, Randy will call the new kit Coming & Going. Clever names have always been a favorite of model railroaders and Randy earns a gold star for this one. Visit www.downtowndeco.com for details.

About our news and events editor



Richard Bale writes our news column under the byline of *The Old Yardmaster*. He has been writing about the model railroad trade for various hobby publications since the 1960s.

Richard is currently introducing 3 of his grandsons to the hobby by involving them in the construction of his fifth layout. He enjoys building models, particularly structures, some of which appeared in the June 2006 issue of *Model Railroader* magazine.



Send us your product announcements!

If you are a hobby manufacturer with a product you want to announce, [just click here](#) and submit your announcement to us!

Future releases from **Accurail** will include a group of 89-foot partially-enclosed bi-Level auto rack cars. The new **HO scale** models are based on the company's existing Paragon rack with the addition of some nifty looking corrugated side panels. Road names scheduled at this early date include Santa Fe, Union Pacific, B&O, PRR, NYC, CN, N&W, Wabash, C&O, Southern, NP, GN, C&NW, Milwaukee and D&RGW (Figure 1).

Look for **Aristo-Craft** to introduce a **G scale** 2-8-0 Consolidation steam locomotive late this year. Full details remain sketchy but the pilot model appears to have a B&O class E-27 heritage (Figure 2).

ExactRail says it will begin shipping its new **HO scale** Trinity Hy-Cube box car by mid-July. Road names on this release include TTX (yellow), SRY (red), SRY (blue) and CN (brown). Also due in July is ExactRail's new PS 4427 covered hopper which is being issued under the company's Platinum series.



FIGURE 1: Preproduction mockup of Accurail's partially-enclosed auto rack cars coming later this year.

Among the special features of the series are detailed air hoses, coupler cut bars, wire hand grabs and separate ladders. The eight road names on this release are Milwaukee, ATSF, BN, UP, RI, NP, C&NW and Pillsbury. An undecorated version is scheduled for release in October. Visit www.exactrail.com for ordering information.

Highlands Station has a new digital book by George Melvin that photographically documents Alco's beautiful PA diesel locomotive as used by ATSF, D&H, D&RGW, Erie, E-L, GM&O, LV, MKT, MP, NdeM, NYC, NKP, NH, PRR, SOU, SP, UP and Wabash.

Titled "Alco PA: The Burly Beauty," Melvin's 40-page series first appeared in Model Railroading magazine in 1999. The new digital version has 89 photos including 40 in color. Presented in PDF format, the text is fully searchable and all of the photos can be zoomed in for close examination. For further information including system requirements go to www.highlandsstationllc.com.



FIGURE 2: Engineering pilot model of Aristo-Craft's forthcoming 2-8-0 Consolidation.

InterMountain Railway dealers are taking reservations now for fall delivery of **N scale** EMD FP7 A&B units decorated for both Northern Pacific in the elegant Raymond Loewy scheme and Southern Pacific's familiar black widow style.

Also coming late this year are SD40T-2 "tunnel motors" diesels decorated for D&RGW and Southern Pacific's short nose unit. Additional versions of the SD40 are in the future as IMRC plans to modify its basic tooling with a fixture that will allow production of a Canadian National SD40-2W. It should be ready for delivery by the end of this year.

Kadee says it will release an **HO scale** Erie 40-foot box car without a road number late this month. Using standard hobby decals (not included), Erie modelers can add any road number(s) to the car which will come decorated in 1954 factory new box car red. Kadee is giving a September delivery date for

When you see this symbol, it means:



"Click here to learn more!"

Every click tells advertisers an ad in MRH is a wise investment ...

We try to make it really easy for you to leave us feedback. Please click the button below and tell us how we're doing: good, bad, or otherwise.



Newsletter feedback!

CLICK HERE for reader comments on newsletter ...



its new P&N 50-foot box car as built in 1966 with 10-foot Youngstown doors. The P&N car will have a functioning cushion underframe and will be decorated in the blue, as-new scheme.

Atlas is working on a new **HO scale** 73-foot center-partition car for delivery this October. Introduced in 1986 and designated by the AAR as a class FBC, the prototype was specifically designed to efficiently load and off-load lumber and gypsum board (Figure 3).

In addition to the usual Atlas features, the center-partition car will have simulated tie-loops and ratchets, partition cable hooks, etched cross-over walks and will ride on newly-tooled 286k trucks.

Also in the works for release this fall in Atlas's Trainman series is a short-bulkhead flat car, a design intended for carrying high density loads such as sheet steel, pipe, rebar and structural steel. A 20-foot high-cube trash container is also due soon from Atlas. No delivery date yet but Atlas is developing both **N scale** and **HO scale** versions of an NSC 42-foot coil



FIGURE 3: Pre-production sample of 73-foot center partition car coming this fall from Atlas.

car. Road names on the initial release are expected to be Canadian National, CSX, Kansas City Southern and Norfolk Southern.

Several pre-production versions of **Bowser's** soon-to-be released San Francisco F-Line PCC trolley cars shown at the recent East Penn Traction Meet drew raves from attendees. The models accurately portray the 14 former Philadelphia PCCs that are now in daily use in San Francisco. The one-piece body is designed to mount on Bowser's proven power chassis.

Traction specialist, Custom Traxx, collaborated with Bowser in developing the **HO scale** project including handling the research for the lettering and complex paint schemes. George Huckaby of CustomTraxx said particular attention was given to determining the paint specifications since a hobbyist would be able to actually compare a model with the real thing.

The initial release of the first four cars is scheduled for late July and will include Los Angeles Railway



FIGURE 4: Bowser PCC car decorated by traction guru George Huckaby as F-Line Philadelphia Transportation Co. No. 1055.

(two-tone yellow with silver stripes), Philadelphia Transportation Company (green & cream with red belt rail), Cincinnati Street Railway (yellow and gray with green stripes) and Pacific Electric Railway (red, orange and gray, post-1940).

Decorating schemes for the second release due later this summer are yet to be decided. An interesting non-operating souvenir car with plastic wheels and chassis is being marketed to the gift industry.

Summer releases coming from vehicle manufacturer **Classic Metal Works** include **HO scale** piggy-back trailer sets decorated for Chicago & Northwestern and Rio Grande Motor Freight.

Foscale Limited has introduced Tower Gas & Walt's Garage, a new **HO scale** craftsman structure kit adaptable to



FIGURE 5: Tower Gas & Walt's Garage is the newest HO structure kit from Foscale.

almost any period being modeled. The small gas station features a distinctive tower and a large assortment of appropriate signage. A nice assortment of metal detail parts are included with the kit. The completed structure of this limited edition kit occupies a footprint of 3.5 x 5-inches. Visit www.foslimited.com for more details.

Among new **HO scale** sets from **Microscale** are Rio Grande D&RGW caboose from the 1972-91 era featuring "The Action Road" slogan in both dash and solid line frames. The lettering is black and the decal set includes a variety of white safety diagonals. Other new decal sets include Kansas City Southern GP7 diesel from the 1949-1962 period with bold "KCS" in red, and a KCS Southern Belle Trinity Hopper.

Ever wonder what it would be like to operate a real steam locomotive? You can rent a full size 2-8-0 from the **Nevada Northern Railway** which has recently refurbished its venerable ALCo-built Consolidation. Check out the details at www.nevadanorthernrailway.net.

Overland Models says it will begin delivery of its British Columbia Railway GF6c AC-1004 and AC-1005 electrics in late June. The **HO scale** model locomotives feature colorful factory paint, accurate lettering, operating

 **Newsletter feedback!**
CLICK HERE for reader comments
on newsletter ... 

headlight and ditch lights, Kadee #58 couplers and a DCC plug. The brass models of the EMD locomotives are being built in Korea by Ajin Train Model.

Structure specialist **Full Steam Ahead** will soon begin shipping a new **HO scale** craftsman waterfront kit called Troels Kirk Cannery. Assuming all goes well and no surprises occur in preparing the assembly instructions, shipment of the limited edition kit was to begin in late June. The price is expected to be in the \$120 to \$140 range. Visit www.fullsteamahead.ca



FIGURE 6: New waterfront structure from Full Steam Ahead to be offered in HO scale.

for details and ordering instructions (Figure 6).

Precision Scale will have its **HO scale** brass models of New Haven class Y-4 and Y-4a 0-8-0 switching locomotives ready for dealers in July or August. The series will include a 1924-era version with a class V2 Vanderbilt tender and a 1928 version with class W-10-D clear vision tender.

Also coming from Precision Scale this summer is a plastic D&RGW vestibule coach with brass details, full interiors and brass trucks. Both **On3** and **On30**

versions of the hybrid coaches will be produced. Factory painting will include the 1930s/40s-era Pullman green and 1950s-era Silverton car decorated in Rio Grande gold. A Pullman green coach without lettering will also be available (Figure 7).

Railflyer Model Prototypes has released a revised kit for an **HO scale** GMDD Wide Cab MK 4013. The kit is composed of an injection molded one-piece body plus additional injection molded and photo-etched detail parts.

Revised features include new window gaskets, window inserts, and windshield wiper gaskets. For more info visit www.railflyermodelprototypes.com.

Brass importer **Rich Yoder Models** is taking reservations for the final group in its series of **O scale** ACF Type 7 high roofway tank cars. This last production group includes 6,000, 8,000 and 10,000 gallon cars in both single and multiple dome styles. For more information including a detailed history of the prototype visit www.richyodermodels.com (Figure 8).

San Juan Car Company will expand its line of track products with the addition of code 100 Flex Track with center-connected ties, an exclusive feature that is said to permit smoother radius and more evenly spaced ties.



FIGURE 7: Hybrid plastic and brass D&RGW coach available this summer from Precision Scale.

The new track sections are 1 meter (39.3-inches) in length and will come in 4-packs and 25-packs. Visit www.sanjuancarco.com for details.

Stella Scale Models has new coal loads for several popular **HO scale** cars including Athearn offset-side twin hopper, Atlas offset-side twin hopper, Accurail USRA twin hopper, Walther's-Trainline series twin hopper and Stewart/Bowser 70-ton 12-panel triple hopper. The loads are cast in solid pigmented resin so no granules can break loose and foul trackwork. Special volume pricing is available on lots of 40 or more loads. Visit www.stellascalemodels.com.



FIGURE 8: "Hand crafted preproduction sample of O scale high roofway tank cars imported by Rich Yoder Models."

Rapido continues to expand the selection of passenger car types in its feature-laden **HO scale** Super Continental Line as well as its equally well detailed **N scale** Panorama Line. Plan on these models arriving during the winter of 2009-2010.

Road names and paint schemes for the new **N scale** "Dayniter" coach that we mentioned last month will include Central of Georgia, Chesapeake & Ohio, Illinois Central, Louisville & Nashville, Milwaukee Road (UP colors), Missouri Pacific, Norfolk & Western and Ontario Northland, plus an undecorated car.

The newest addition to Rapido's **1/87 scale** Super Continental Line is a buffet-

parlor car based on the Canadian National Pullman-Standard plan 7638. Introduced more than 50 years ago, the prototype CN buffet-parlor and cars like it saw service throughout the United States and Canada. Decorating schemes will include Amtrak (Phase 1), Canadian National (1954-era), Chicago & North Western, Erie, Grand Trunk Western, Great Northern, Gulf, Mobile & Ohio, Milwaukee Road, Missouri Pacific, New York Central and Northern Pacific.

Digital Fox Service, the custom decorating outfit that specializes in Accurail equipment, has an **HO scale** 3-bay covered hopper decorated for West Central Soyplus. The car is available direct only at www.digitalfox.com (Figure 9).

Eastern Seaboard Models has prepared tooling for a Pennsylvania Railroad 65-foot class G26 mill gondola. The one-piece injection molded plastic body is supported by a metal diecast underframe. The kit includes separate drop-ends that can be positioned either up or down. The kit comes with Micro-Trains #1015 couplers and M-T trucks fitted with low-profile wheelsets.

Over a third of the 1,650 cars Pennsy built in the early 1930s lasted into the Penn Central era. And several of the gondolas survived after Conrail took ownership. Schemes available in the **N scale** kit will include Conrail, Penn Central and PRR in both circle and shadow keystone heralds (Figures 10, 11 next page).

Industry News

Best wishes to Brian Leppert, the engineering expert behind Tahoe Model Works, who suffered a heart attack May 31st.

Mrs. L reports Brian is recovering nicely from emergency bypass surgery, but since Tahoe is a one-man shop, it may be a few weeks before her



FIGURE 9: Custom decorated Accurail covered hopper available from Digital Fox Service.

MODEL TRAINS WEATHERED .COM

THE WORLD'S ONLY WEATHERER'S NETWORK FORUM

STOP BY TODAY AND INQUIRE ABOUT MEMBERSHIP

husband is able to begin filling orders. The good news is that Brian now has some time to build a model or two.

John Winston, 65, passed away May 27, following a two-year battle with cancer. Over the years Mr. Winston built and relished his reputation as a colorful and frequently outspoken dealer of imported brass models and was probably best known to model railroaders for the long-running Brass Buyer's Guide he published under the pseudonym of Bob Brass. ■



FIGURE 10: End detail on PRR mill gondola under development by Eastern Seaboard Models.



FIGURE 11: N scale PRR gondola available soon from Eastern Seaboard Models.

Briefly noted at press time...

...Authorities in Canton, Ohio, are holding the alleged murderer of the wife and grandchildren of Jim Eakin, founder of **Railhead Publications** and publisher of *Short & Narrow Rails* and *Traction Prototype & Models* magazines.

Although Jim hopes to continue publishing his line of books, the future of the magazines is less clear. Family members have asked that readers of Jim's publications wait a reasonable period of time before flooding him with inquiries about the status of their subscription.

...**Sylvan Models** will have samples of its new HO scale Mack B-67 single and tandem axle tractors at the National Train Show in Hartford.

...**Division Point** will launch a project to recreate the famous Norfolk & Western 6-6-6-6 steam turbine locomotive #2300 in HO scale. Best known to N&W fans as "Jawn Henry," the imported brass model will include the unique auxiliary water tender as an option.

...**Funaro & Camerlengo** now has an HO scale one-piece body resin kit for a Pennsylvania Railroad class GLca hopper car.

...**Harold H. Carstens**, publisher of *Railroad Model Craftsman* and *Railfan & Railroad* magazines, died peacefully at his New Jersey home on June 23rd.

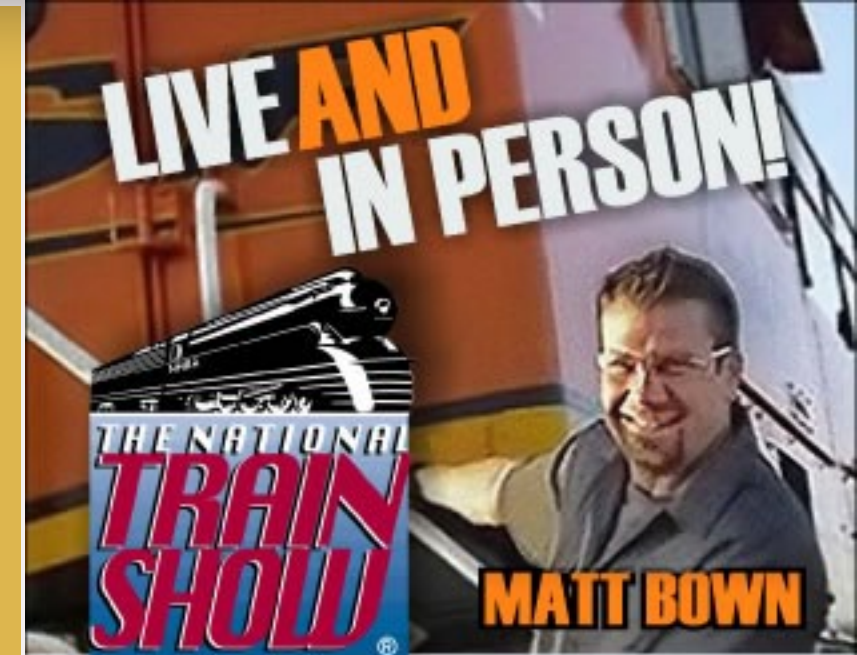
A lifelong rail fan, modeler and active train collector, Hal Carstens was widely recognized for his numerous contributions to the hobby that spanned for than fifty years.

He was a life member and early supporter of NMRA and received the organizations Distinguished Service Award in 1962. He served as president of several organizations including the Hobby Industry Association (HIAA) in 1971-72, Model Railroad Industry Association (MRIA) 1977-78 and Train Collectors Association 1964-65. He received the HIAA Meritorious Award of Honor in 1979 and was elected to the MRIA Hall of Fame in 1996. In 1989 NMRA named Mr. Carstens the Model Railroad Man of the Year. ■



Newsletter feedback!

CLICK HERE for reader comments on newsletter ...



at the National Train Show in Hartford, CT

host of **Extreme Trains**



Watch the Model Railroad Hobbyist web site for video coverage of this year's National Train Show!

July 10-11 ONLY
Booth #280-281

Brought to you by



click to learn more about this sponsor



Selected Events

July 2009

CONNECTICUT, HARTFORD, July 5-11, NMRA National Convention, Connecticut Convention Center. www.hn2009.org.

CONNECTICUT, HARTFORD, July 10-12, National Train Show, Connecticut Convention Center.

FLORIDA, DELAND, July 11, 28th Florida Rail Fair, Volusia County Fairgrounds, Lawrence Arena. www.gserr.com/shows.htm.

CALIFORNIA, MCCLELLAN (Sacramento), July 22-26, National Summer Steamup (small-scale live steam meet), Lions Gate Hotel. www.summersteamup.com.

MICHIGAN, OWOSSO, July 23-26, Steam Railroading Institute Train Festival 2009, featuring excursions behind several operating steam locomotives. www.mstrp.com.

August 2009

MISSOURI, ST. LOUIS, August 4-8, 2009, National Association of S Gaugers Annual Convention, Airport Marriot Hotel, Bridgeton. www.nasg.org.

OREGON, SALEM, August 21-22, Rails By The River, a prototype modelers meet, Center50+, 2615 Portland Road, Salem, OR 97301. railsbytheriver.com.

OREGON, GARIBALDI, August 22, [Oregon Coast Crawler excursion](#) behind Curtiss Lumber Co. Heisler #2 sponsored by Oregon Coast Scenic Railroad.

Future 2009

COLORADO, COLORADO SPRINGS, September 16-19, 2009, 29th National Narrow Gauge Convention, Doubletree Hotel, 1775 East Cheyenne Mountain Blvd. www.29nng.com.

SAN BERNARDINO, CALIFORNIA, September 19, 2009, Western Prototype Modelers Meet, Santa Fe Depot, 1170 West 3rd Street. www.westernprototypemodelers.org.

ILLINOIS, NAPERVILLE, October 29-November 1, 2009, 16th Annual Prototype Modeler's Seminar sponsored by Sunshine Models.

MASSACHUSETTS, MANSFIELD, November 12-14, 2009, Craftsman Structure Show, Grand Holiday Inn Hotel & Convention Center. www.css09.com. ■



FEELING DOWN?

YOU WON'T BE LET DOWN WITH CF SHOPS!

WE'LL GO TO THE ENDS OF THE GALAXY FOR OUR CUSTOMERS!

Cf Shops is an on-line, CUSTOMER ORIENTED Direct Order Hobby Shop.

We are Model Railroaders Too and we treat every customer the way we want to be treated.

WITH OUTSTANDING CUSTOMER SERVICE
AND RESOURCES, BEYOND YOUR OUT-OF-THIS-WORLD EXPECTATIONS
MENTION

MODEL RAILROAD HOBBYIST MAGAZINE

FOR AN ADDITIONAL 10% OFF YOUR FIRST ORDER

MRH Sponsor Spotlight: Micro-Mark



Model Railroad Hobbyist magazine™

Issue 4 sneak peek ...

The screenshot shows the Micro-Mark website interface. The top navigation bar includes the Micro-Mark logo, the slogan 'THE SMALL TOOL SPECIALISTS', a toll-free number '1-800-225-1066', and a shopping cart icon showing '0 items (\$0.00)'. Below the navigation is a search bar and links for 'Home Page', 'My Account: Login/Create', and 'View Cart / Checkout'. The main content area features a 'Welcome to the NEW Micro-Mark Web Site!' banner with images of various tools and an 'ECONOMIC SALE!' badge. A secondary banner below it shows a 'To begin shopping, click on a product category below:' section with a list of categories including Adhesives, Books, Carvers, Clamps, Drills, and more. The 'Drill Bits, Taps, Dies & Reamers' category is highlighted, showing three sub-sections: 'DRILL BITS & ACCESSORIES', 'TAP SETS, TAP HOLDERS & REAMERS', and 'TAPS, DIES & DRILLS'.

The magazine cover features the title 'Model Railroad Hobbyist magazine™' and the subtitle 'The model-trains-video.com mediaZine'. It is dated 'Fourth Quarter 2009'. The cover image shows three men, likely the authors of the featured articles, working on a detailed model train layout. The layout includes a water tower, a roundhouse, and various buildings. Text on the cover highlights new series: 'Building an operating turntable and roundhouse' and 'CSX SD38 Painting'. Other articles mentioned include 'Operating switch stands Using 3rd PlanIt, part 3' and 'Better windows for structures'.

Micro-Mark is *Model Railroad Hobbyist's* newest sponsoring advertiser, and we're excited to have them aboard!

Micro-Mark certainly embodies their slogan as being "The Small Tool Specialists". The Micro-Mark web site is a hobbyist's mecca of hard-to-find small tools and hobby supplies.

Micro-Mark's rich web site presents an easy-to-browse "online catalog" that's loaded with great product information

and photos. We find their web site to be a real delight to shop!

If you're looking for some great deals, make sure you check out their *close outs* and *special offers* (see the left-hand navigation menu). And while you're at it, don't forget to check their *new items* section – Micro-Mark adds new-and-interesting products to this section regularly.

[Click here to visit the Micro-Mark web site.](#)

Model Railroad Hobbyist magazine
Openly available to every model railroader on the planet with an internet connection!

Issue 4 release date:
October 2009



Subscribe to **Model Railroad Hobbyist magazine™**
click here

Alcos in the Alcove

Overlapping functions for space-savings

— by **Byron Henderson**

www.LayoutVision.com



Paul Swanson photo

Figure 1: The Mid-Continent Railway Museum's ALCO RSC-2 #988 has been restored to its 1947 as-delivered paint scheme, similar to the KATO HO model that inspired the setting for this issue's switching layout. Photo courtesy the [Mid-Continent Railway Museum](http://www.mcrmuseum.com), North Freedom, WI.

The alcove in the corner was crying out to my layout design client for some kind of model railroad project. So a sheet of plywood was cut at the lumber yard to yield a 5'X2' shelf, which sat forlornly for many months. Meanwhile, dreams of a simple diorama had blossomed into switching layout aspirations.

Happily, negotiations with the household planning commission allowed the

5'X2' off-cut (less the saw kerf) to be joined to the original shelf. Land grab accomplished – but now what to build?

The kit inventory included GCLaser's beautiful model of the Sturtevant, Wisconsin Milwaukee Road station. Since a pair of smooth-running Kato RSC-2 MILW diesels was also on hand, the search for a prototype was complete. But accommodating the rest of the stockpile was trickier.

Finding space for kits and cars

The Sturtevant depot is a unique design since it served two different MILW lines at a near 90-degree crossing. It's also fairly large for an HO station, so I decided to place it first at the far corner of the alcove shelf. This allowed me to provide just the suggestion of a crossing line without using much space.

Crossings often imply interchange, so an interchange track is included. (The owner may choose to represent a different railroad or just another MILW line.) In order to increase the overall appeal, I set the 90-degree crossing and other tracks at a slight angle to the room and the shelves.

With one kit down, I turned to the rest of the inventory. Sturtevant is about twenty miles south of Milwaukee, but the client wanted a bit more of a granger feel by including Walthers' ADM Grain Elevator (AGE) and GCLaser's County Co-Op (CCO) across the main line from one another.

Other must-have structures included American Model Builders' A.C. Brown Manufacturing (ACB) and Walthers' Merchants Row II (MR2). Although it's not my usual design approach to start with

building footprints, I thought that might be the best case here with these relatively large structures.

Curves and straights (and structures)

The alcove shelf obviously was going to have to host some curves, so it seemed the best spot for the granger-inspired scene would be along the other shelf.

With that in mind, I placed the elevators where there would be some length for their spurs to extend. In real life, grain elevators and similar industries need room for the cars to be rolled under spouts or over dumps and then rolled away for the next car to be handled. This is often ignored on model plans.

For the ADM elevator I had to cheat a little – OK, a lot. The switch crew shoves the string of cars all the way into the elevator track (toward the bottom of the track plan) by first backing the string into the elevator lead.

Then as each car is loaded, I assume the grades are such that it can roll back down to the end of the elevator lead, clearing the switch for the "next day's" switch crew to pick up the string. (I've seen a similar configuration once in real life, but not on a curve and there was a car puller at the end.)

The County Co-Op has a more typical arrangement, though only a few cars may be set out between the grain spout and the clearance point of the switch, and then allowed to roll to the end of the track as they are loaded. (Actually, we'll slide them to the end of track between sessions, but you get the idea.)



Figure 2: Although the freelance track plan must curve to fit the alcove, keeping some track straight suggests a granger atmosphere suitable for grain elevators.

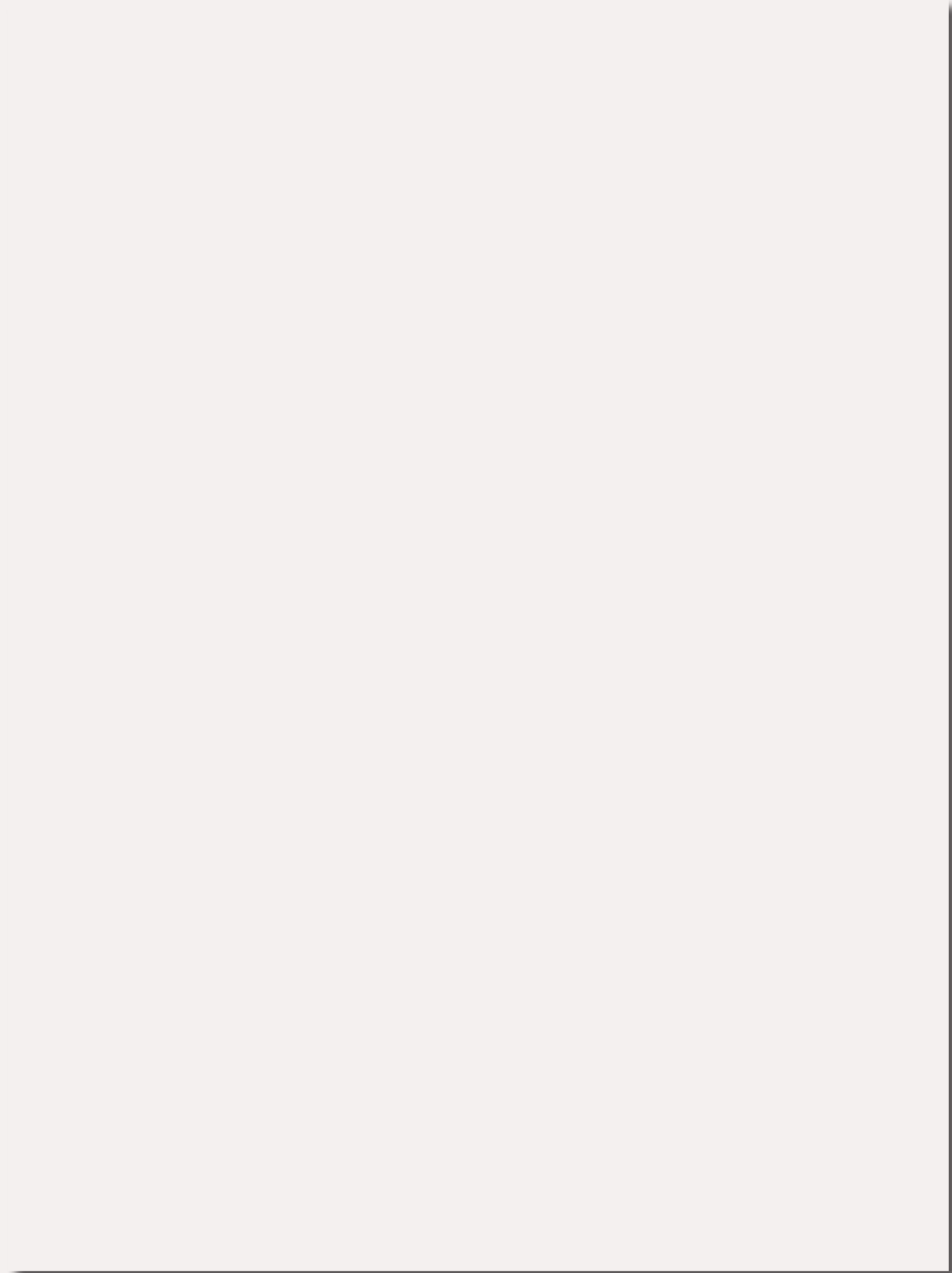


Figure 3: Thoughtful planning allows some tracks to be used multiple times as switch leads and runarounds, helpful in such limited space.

A.C. Brown just fits in the upper left-hand corner. This space would also have been a good spot for a team track or oil distributor, which would have offered more variety in car types.

The balance of the structure footprints shown are just placeholders –kits for these locations will be chosen during construction. The scene along the left side offers a chance to model the “back-side” of structures, perhaps with a bit of clutter. But not too seedy, this is the Midwest, after all.

The resulting track plan creates as much straight track as possible, but lays it at a slight angle to the shelf. Since these are fixed shelves, not sections, there was no attention paid to minimizing the number of tracks crossing the benchwork joint.

While it’s not the maximum number of industries possible in the space, the industry structures and tracks are substantial enough to be more realistic.

Substituting more industries with loading doors docks (rather than the elevators that must leave track clear) and/or using flats along the wall would also allow more industries in a similar configuration.

Overlapping and double-duty tracks

One trick new layout designers often miss is overlapping the various functions along the benchwork. If we can use the same linear stretch of shelf for runarounds, switching leads, and industry tracks alongside one another, we can incorporate more fun and interest in a given space. (Figure 3 previous page.)

In addition, we can use some track segments for multiple purposes, acting at various times as a switching lead, a portion of the runaround, or a “for now” place to stash cars during switching. The figure shows how the various tracks are used at different times.

While the owner will probably only use one of the two RSC-2s at a time, the ends of the runaround tracks are just long enough to accommodate the two

together – just in case. But the extra length of the two locos would limit the number of cars that could be easily switched in a session.

Operating in the alcove

One might start the session with a short train on the “main.” The crew needs to plan their work, taking a look at the industry tracks for the pulls and the “put-backs”. These are the cars that have not yet been loaded or unloaded and need to be returned to their original spots.

The crew also must decide where to stash the caboose and their pulled cars to keep them out of the way while switching.

Next the crew works the industry tracks and interchange, pulling and spotting cars as needed.

To end the session, they can shove the interchange with the outbounds and perhaps arrange their own train for “eastbounds” and “westbounds” before picking up the caboose and imagining rolling back to the yard. Not a bad day’s work!

Byron Henderson is a custom model railroad layout designer from San Jose, CA. His own under-construction proto-freelance N scale layout, the [Oakland Harbor Belt](#), is focused on waterside freight terminal operations near Oakland, CA in 1955. Byron is a member of the [Layout Design SIG](#) and [Operations SIG](#), and is a past editor of the *LDSIG's Layout Design Journal*.



Article feedback!

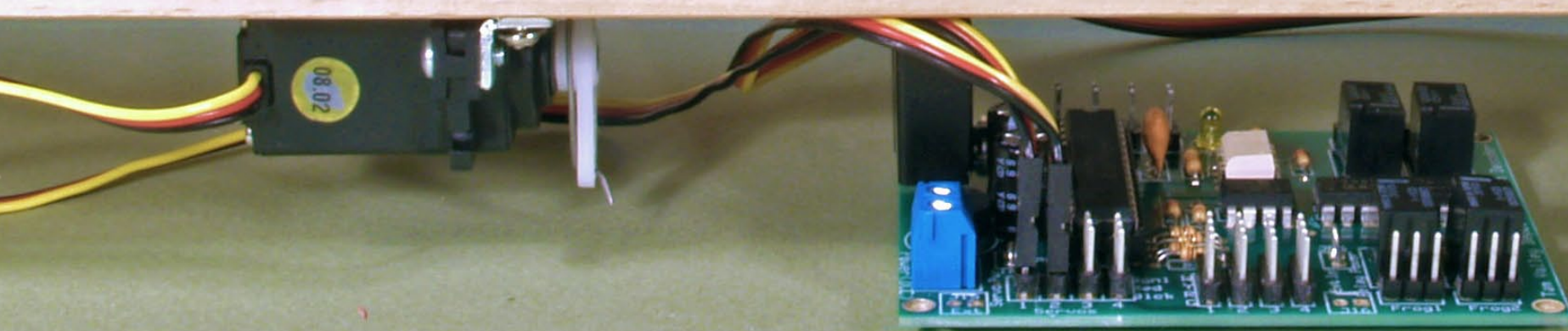
CLICK HERE for reader comments on this article ...



Figure 4: Chicago & North Western EMD GP35 number 864 leads a mixed MILW & CNW consist past the Sturtevant, Wisconsin depot on May 4, 1976. Image copyright by [Mike and Mark Nelson](#), used with permission.

R/C Servos for Model Railroading:

Powerful new low-cost technology with exciting model applications



– by *Duncan McRee*
Photos by the author

The ideal device for throwing a model railroad turnout would be a small motor with high torque, variable speed and minimal power need. A device that could be easily attached to the bottom of the turnout with minimal effort, say with foam tape. It should have a low

profile so that it can fit within the benchwork, whether it is traditional, multi-deck or foam. It should be controllable manually, by signal logic, and by DCC. And it should be inexpensive. Sound too good to be true?

Such a device does exist. The R/C servos commonly used by model airplane and robotics enthusiasts fit the bill quite nicely, as long they are coupled to the proper controller. A good servo suitable for throwing turnouts will cost less than \$10.

Servos allow the model railroading community to join in the economy of scale that these little marvels enjoy. Many of us who dabble in more than

one hobby already have a number of servos on our shelves and have thought we should be able to use these on our layouts.

I decided to build a multi-deck layout, and I became intrigued with using servos to control my turnouts. Before that I relied on the venerable Tortoise™ as a turnout motor. However, a Tortoise™ sticks down too far to work well on an upper deck.

Tony Koester's excellent book "Multi-Deck Layout Design" suggests that the upper deck thickness should be the thickness of a plywood shelf with a light fixture attached on the bottom to light the lower deck. This means 2-2.5" is a good thickness with the switch machine getting about 2" of this space. Servos fit the bill perfectly, being only about 1/2" thick (Figure 1).

I had a lot of old servos lying around the workshop because two of my temporary hobbies (my permanent hobby, since I was about 14, being, of course, model railroading) in the past were flying R/C electric model airplanes and battling one-pound robots. I used R/C servos for both. These little servos are remarkably tough. I have crashed all of my planes at least once and the servos always survived to fly again.

As to battling robots, I often had to push the pieces of my poor bot into a cardboard box to carry it home. As long as the servo wasn't actually cut by a rotating saw-blade weapon, they survived to fight again. Now these servos are retired to the bottom of my layout.

Some research on the Web will uncover a few sites that have used servos for controlling model railroad turnouts. I am not claiming to be the first by any means. They seem to be popular in Australia and I found one site in England. I also frequently meet modelers who have thought about using servos but, for one reason or

another, have not gotten around to it. I hope this article will inspire you to give it a try. I think you will find that these little mechanical marvels are easy to use and very versatile.

I have come up with a few different ways to attach the servos to turnouts depending upon the situation: a direct drive on the bottom of the sub-roadbed through a slot, a direct drive attached directly to a plate on the bottom of the switch, which works well for foam roadbed; and a crank through a small hole, that is useful for retrofitting already laid switches.

I will show you step-by-step instructions. For the crank method, you can see step-by-step details at my Tam Valley Railroad website (www.tamvalleyrr.com).

Servos need a special input signal to move them (see the section "How Servos Work" - Page 6). This signal is easily generated by a microprocessor but not by diodes and switches, the control stuff most model railroaders are used to.

You can generate the signal with 555 timers and a bunch of resistors and capacitors, but a microprocessor is ideally suited for controlling servos. A microprocessor is less expensive these days than all of the individual parts needed, because one \$4 microprocessor with 20 I/O pins can control a number of servos and still have pins for LED indicator lights, pushbuttons, and DCC inputs.



FIGURE 1: Three sizes of R/C servos with an HO scale locomotive and a penny for size comparison. From the left are a standard, mini and micro servo. All 3 servos have a standard 3-pole plug and despite their different sizes and all respond identically to standard R/C servo signals. The white servo arms can be replaced by a wide variety of different size and shapes for connecting to different devices. In this article I show a few uses for model railroads including turnouts and semaphores.

A number of options are available for the control boards. I have seen ads from several companies in the hobby magazines and they are available from my own startup company Tam Valley Depot (<http://www.tamvalleydepot.com>).

A board costs \$25-40 depending upon the features and can drive from 4-8

turnouts. The boards often double as DCC accessory decoders and can also be interfaced to signaling/CTC systems.

The first controller I designed was my Quad Servo Accessory Decoder (Fig. 2), which can control four servos and can respond to DCC inputs or pushbutton controls. It is also possible to connect it to other control systems,

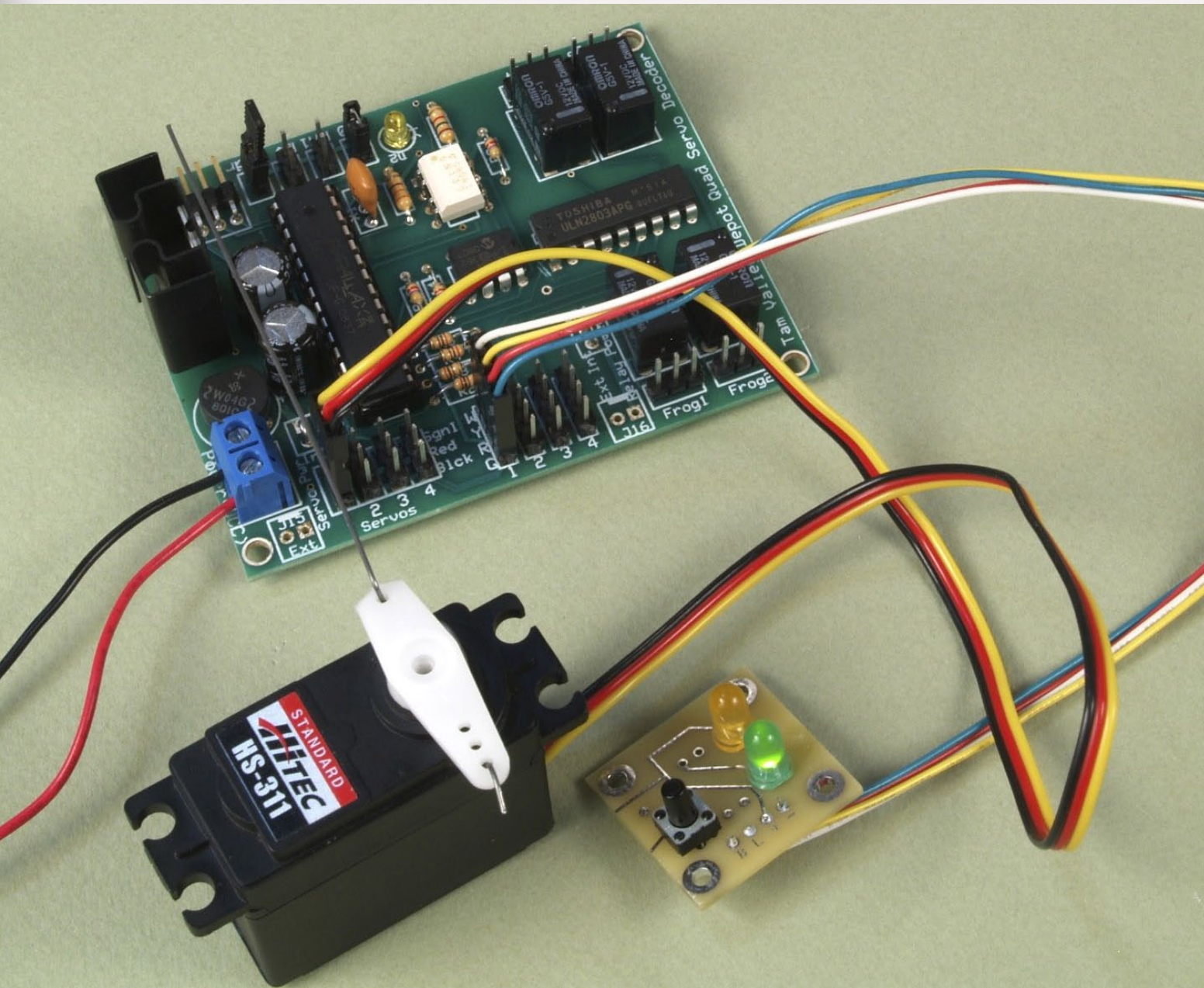


FIGURE 2: Some form of electronics is required to generate the signal required by servos. Shown here is a DCC stationary decoder based on a microprocessor for driving servos from Tam Valley Depot. The board can drive up to 4 servos and can be controlled either by the button controller (lower right), a DCC signal or signal logic. Relays are provided for switching the frog power.



FIGURE 3: Turnout on Craig Bisgeier's Housatonic railroad powered by a servo and the original Octopus 8-servo driver. The turnout is hand-laid by Craig using Fast Tracks tools. The turnout has solid rail points, which are easily thrown by the servo.

i.e., a signaling system, that use logic-low outputs. Driving four turnouts spreads the cost of the PC board and the microprocessor across several turnouts.

I sent early versions to Ryan Andersen and Will Ayerst, the hosts of the Model Railcast Show (Ryan also does a column in this e-zine), and Ryan installed his first servo underneath a turnout in about 5 minutes. Ryan posted an excellent video on the Quad and his installation on his Railcast website (www.modelrailcast.com).

Craig Bisgeier, of Housatonic railroad fame (www.HousatonicRR.com), heard about the Quad from the show and

he became very enthusiastic, as he had been thinking for some time of using servos for his layout. However, he didn't want "any of that silly DCC decoder stuff" so we came up with the Octopus, a servo driver that can control up to eight servos from eight toggle switches.

Craig kindly provided me with a photo of one his servo installations (see Figure 3). By driving eight servos with one microprocessor board we were able to get the cost per turnout a little below that of using the Tortoise™. Craig is working on adapting the Octopus to drive a ball signal. These signals have 2 positions, high-ball and low-ball, which is a natural for the

Octopus as it drives servos to two end positions. Input will be manual control - just like on the prototype.

More recently I have built a controller that can drive two servos to three positions each, the Dual 3-Way. This can be used to drive semaphore signals and 3-way stub switches.

Chuck Stancil of Logic Rail Tech supplied one of his Signal Animators and I hooked it up to a Tomar upper quadrant semaphore. After some fiddling, I found that the servo drives the semaphore nicely. In Figure 4 you

can see the semaphore cycle through a green red, yellow, and back to green sequence, driven by the servo underneath the roadbed.

This Dual 3-Way is being driven by logic outputs from Chuck's SA board, but the Dual 3-Way can be hooked up to many other signaling systems.

Jason Reis sent me a nicely built 3-way stub switch so that I could give this a go with my Dual 3-Way (see Figure 5). Initial results were very promising, but then I noticed that the center position was a bit tricky to align.

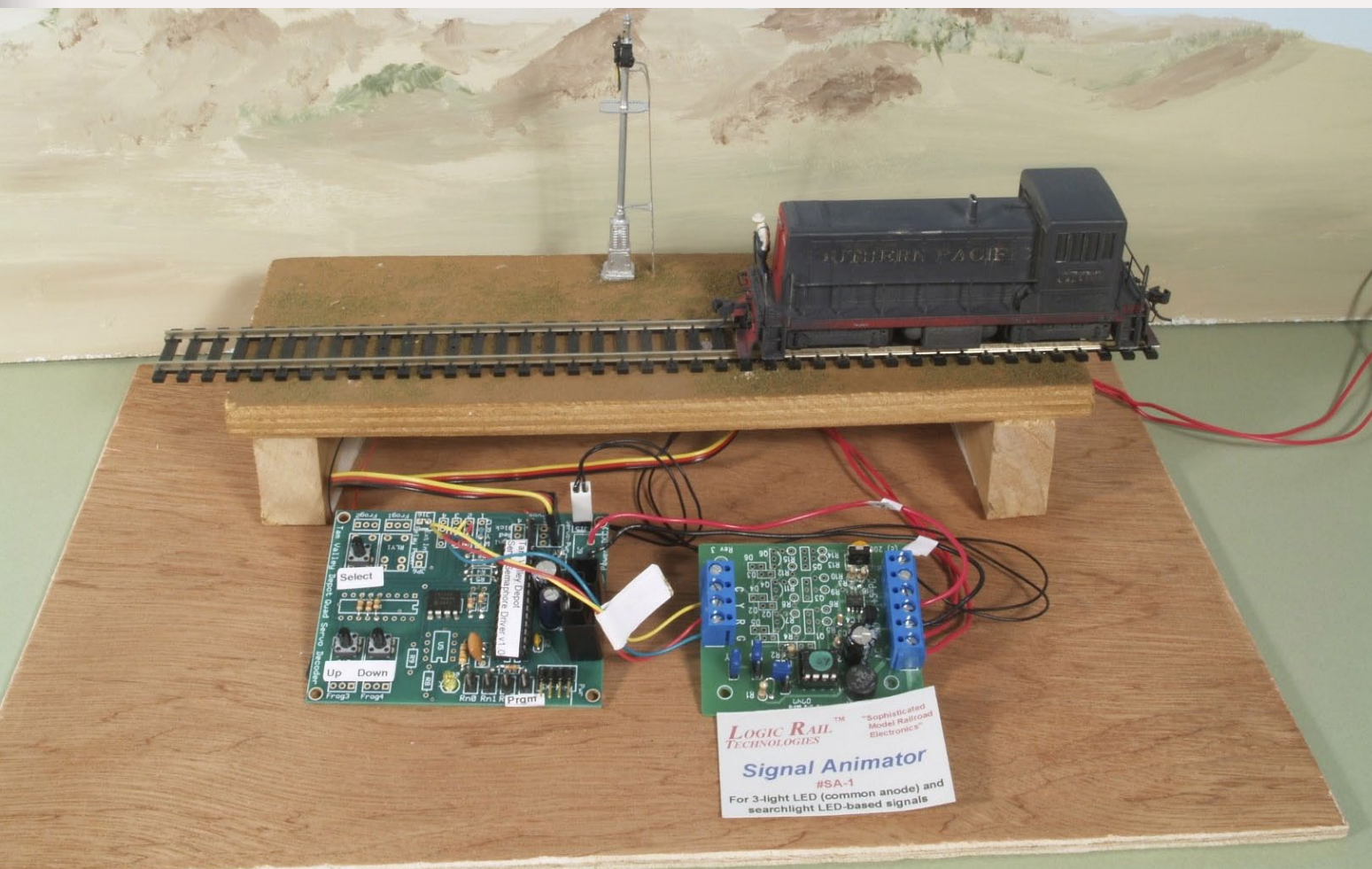


FIGURE 4: An example of electronics for driving a semaphore with a servo. On the right is a Logic Rail Tech signal animator (SA) that senses when a photocell between the tracks is covered, initiating a cycle of stop-caution-proceed (RYG). The SA sends out signals on 3-wires to the Tam Valley Depot semaphore driver on the left which translates the RYG signals into movements of a servo mounted below the semaphore.

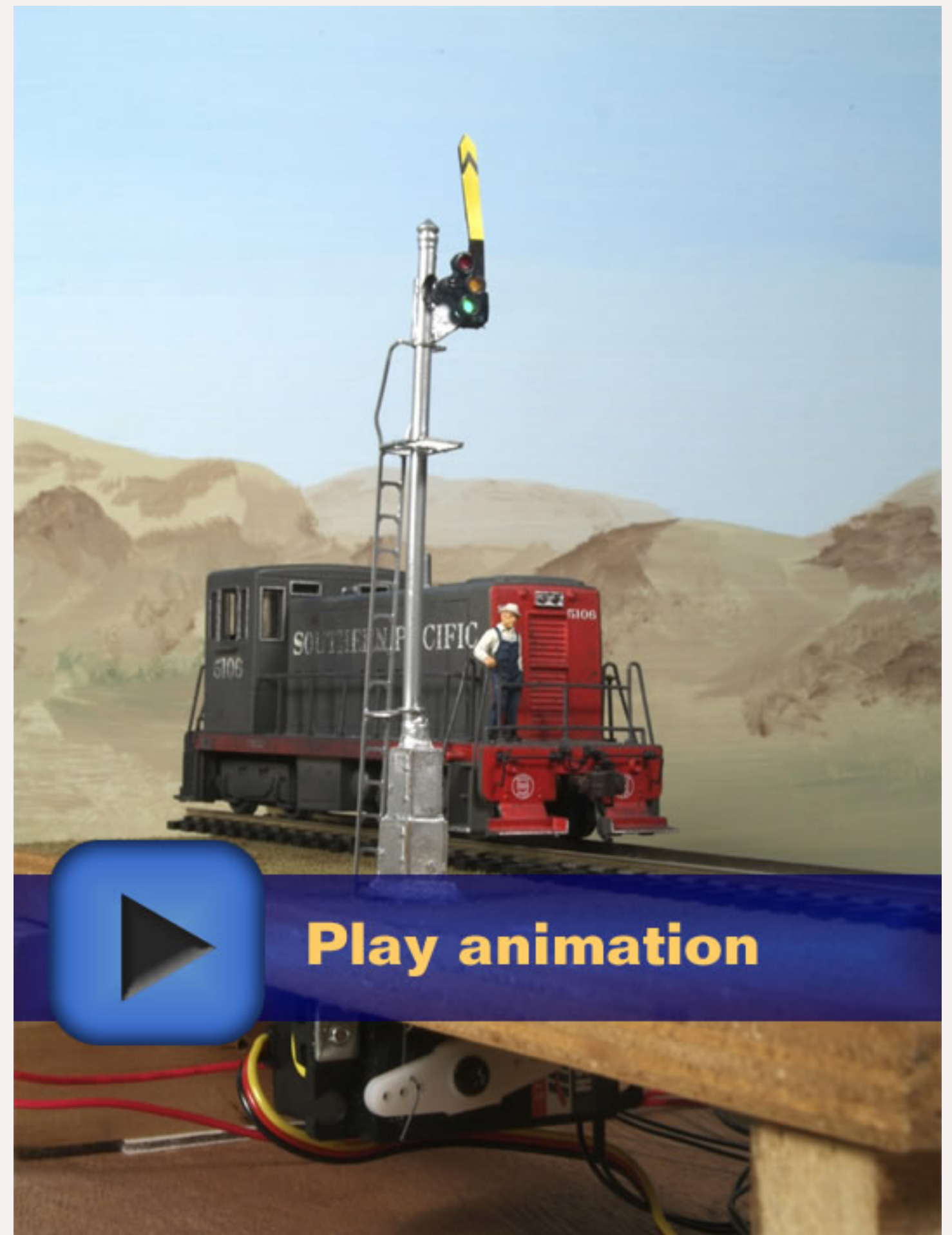


FIGURE 4B: A 3-position upper quadrant semaphore actuated by a servo being run through its paces by an inspection crew.



Play animation

FIGURE 5: 3-way stub turnout. In a stub turnout the approach rails move to switch the turnout. This stub turnout is being controlled by a TVD 3-way DCC decoder driving a standard servo under the roadbed. Trackwork courtesy of Jason Reis.

On, further inspection it became apparent that the alignment depended upon the direction from which the points were driven. If I went from left to center it would stop in one position, but if driving from right to center it would stop about 1/16" from that position.

This is a common problem in motor driven mechanical linkages and is called backlash. Backlash is caused by having a small amount of slop in the system, such that

you end up at slightly different end points when going forward than from backward. It is easily overcome by a technique known as anti-backlash.

In anti-backlash you drive the motor to the final point always from the same direction. So for one direction you drive to the position directly, but if coming from the opposite direction, the motor is driven a small ways past and then reverses and comes back to the final position.

This article is about using servos for turnouts but there are many other uses for servos on layouts for animation and control. I hope to see many articles and clinics from the community as servos find more ways to be used on our layouts. In future articles I plan to give more details on the electronics for driving servos.

Microprocessor Resources for Model Railroads

It is outside of the scope of this article to talk about how the microprocessors are programmed and I doubt most model railroaders are interested, but for those of you who are interested (like me), I can point you to some good sources.

The most popular micro is the PIC series made by Microchips Inc. There are hundreds of books on PIC micros and a bewildering array of PIC chips available. They are especially popular in the robotics community and most model railroad microprocessor products I am aware of have used them. Most likely your DCC controller has one inside as well as your locomotive's decoder.

I can't recommend a particular book for PICs, but the ones sold for robotics hobbyists almost always have a section on using servos. A number of good designs based on the PIC chips for model railroads are available at the MERG website (www.merg.org.uk). The code for all of these is in assembly language and so I was unable to actually make any sense of it.

I like to use the SX series of micros. Parallax, the company that sells the SX chips, has an excellent web site (www.parallax.com) with many details on how to use their chips.

Especially good are the Jon Williams Nuts and Volts magazine articles, which can be found at the

Parallax website. These easily followed articles have details on many circuits for animation and control including several that use servos. Jon programs in BASIC, which is easily followed and heavily annotated to the point where I was able to adapt pieces of his code to get the framework for my decoders.

The BASIC compiler for SX chips is cost-free. Inexpensive prototyping boards are available for experimentation. You can also use one of the bare boards at the Tam Valley Depot as a starting point for your new design (which would be clever because you could also start with my code).

The one investment you will need (besides a Windows PC which you most likely already have) is a \$29.95 SX-Blitz USB downloader for transferring the programs from the PC into the chip.

If people are interested I am willing to start a regular series detailing how to use microprocessors for controlling and animating model railroads. The possibilities for these little chips are endless and I would like to get them out of their current "Black Box" status. ■

How Do Servos Work?

Servos are DC motors with built-in gearing and a feedback loop to sense the position of the output shaft.

A servo is an automatic device that uses feedback to correct the performance of the mechanism. In R/C servos a feedback potentiometer on the output shaft is used to sense the output position, which is then compared to an input pulse.

The motor is driven in the correct direction to minimize the difference. This means that the output shaft closely follows the input signal.

The input signal is a variable-width pulse. A short pulse is one endpoint, a long pulse is the other end and a pulse halfway between these two is the midpoint. R/C servos are designed to center on a 1.5 ms pulse and vary between a 0.9 ms and a 2.1 ms pulse. See Fig. 6).

The pulses are sent every 20 ms, although this timing is not critical. The rate at which a servo moves is controlled by the rate of change of the input signal. In most geared DC motors, slowing the motor is done by lowering the drive voltage, and this also lowers the available torque.

In a servo, on the other hand, very slow movement is possible while maintaining full torque because the speed is dependent on the rate of change of the pulse-width, not on drive voltage. Servos have 3 input wires: signal, V+ and ground. The signal is as just described. V+ is gen-

erally 4.8-6 V which is picked for the common voltages available from a 4-cell NiCad (4.8V) or alkaline battery (6V). And of course both voltages are referenced to ground. The color-coding of these wires is generally red for V+ and black for ground.

The signal wire color varies with different manufacturers. The most common are white from Futaba and yellow from Hitec. Servos from these two manufacturers are interchangeable, as are the R/C servos from most other manufacturers. However, there are a few exceptions, noticeably some Euro designs, that are not compatible, so you should check the technical specifications.

Servos draw just a few milliamps at idle and can draw up to about 700 mA at full stall, which occurs when the input pulse is telling the servo to move but it is being mechanically held in a different position. When servos are being driven between positions they generally draw around 60-100 mA.

Servo Terminology

Analog vs. Digital. Servos fall into two broad categories, those that use analog electronics and those that use digital.

Digital servos have higher speed, better holding power, higher torque and generally cost more. For the purposes of throwing turnouts, an analog servo works fine, and there is no advantage to using digital, although there is no harm in doing so (except perhaps excessive current draw).

Servo Sizes

Standard - generally the largest size and the least expensive. These are the ones to use for driving solid point turnouts.

Mini - midsize servos. These servos usually have as much torque as a standard in spite of their smaller size, but do so with smaller gears that are more prone to stripping. The trouble I have had with these servos is that you can strip the servo by stalling it and continuing to apply power.

Micro - very small servos that have less torque, but still plenty for moving hinged point turnouts. The lower torque means they are actually less prone to stripping under their own power. This means they can be used to drive points against the stock rails with plenty of force without worrying about stripping the gears. They can also be stripped by forcing, so always push the output shaft gently. Very inexpensive versions of these can be had from China.

Pico - the smallest servos available. I have not tried these but assume they would work similarly to the micros. There could be some very interesting uses of these in animation where a small footprint actuator is desired.

Gear Types

Servos are categorized by how hard a material is used to make the gears. Nylon is the softest material and is also the most common. Karbonite, metal and titanium are tougher, and more expensive, in increasing order. Nylon is also the slipperiest of the

materials so that nylon geared servos generally draw the least power when moving.

Hi-torque – These servos use a low gearing so that they have more torque but use more turns of the motor to get there. If a standard turnout isn't able to move something then one of these babies may do it for you.

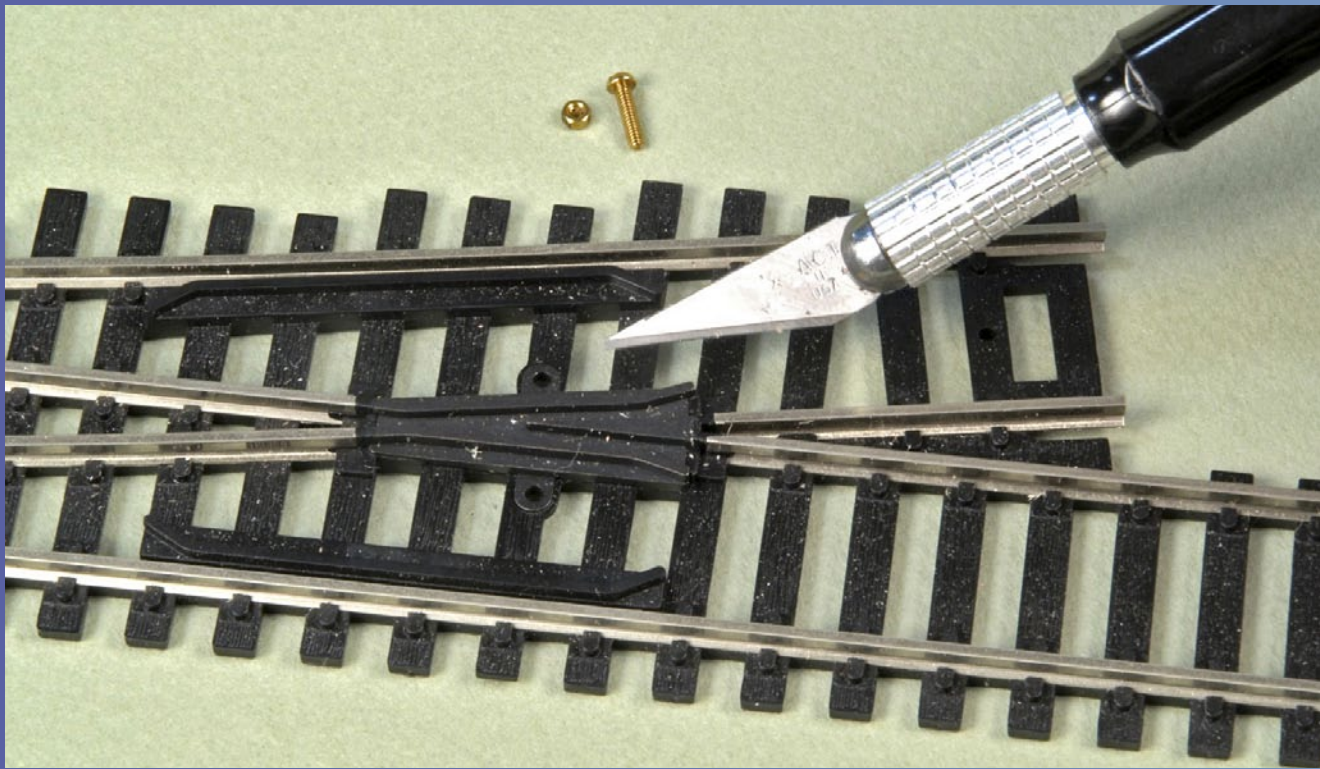
Hi-speed - The high gear analog, these servos move faster but have less power. I can't imagine any application in model railroading where the extreme speed of these servos is needed, but I expect someone else will show me wrong.

Continuous Rotation - a continuous rotation servo is made by breaking the feedback connection to the output potentiometer. This causes the servo to rotate continuously in one direction or the other, with the rate controlled by the pulse width.

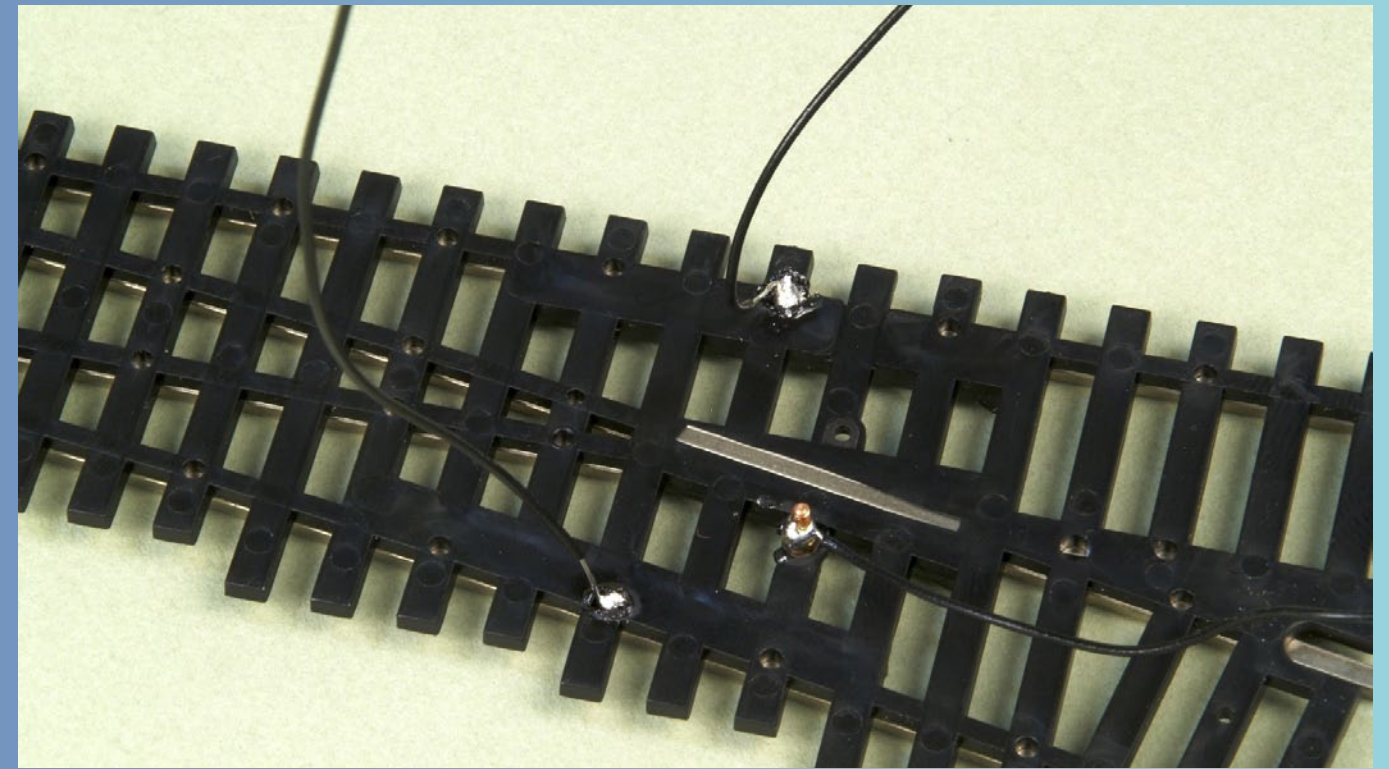
Technically speaking, these are no longer servos because they have no feedback, but are variable speed geared motors. However, since they are commonly made by altering a servo, they are generally considered a type of servo.

Continuous rotation servos are very useful in place of motors in that they allow a servo controller to be used as the speed and direction control of a DC motor. They should have many uses on model railroads, such as a turntable control.

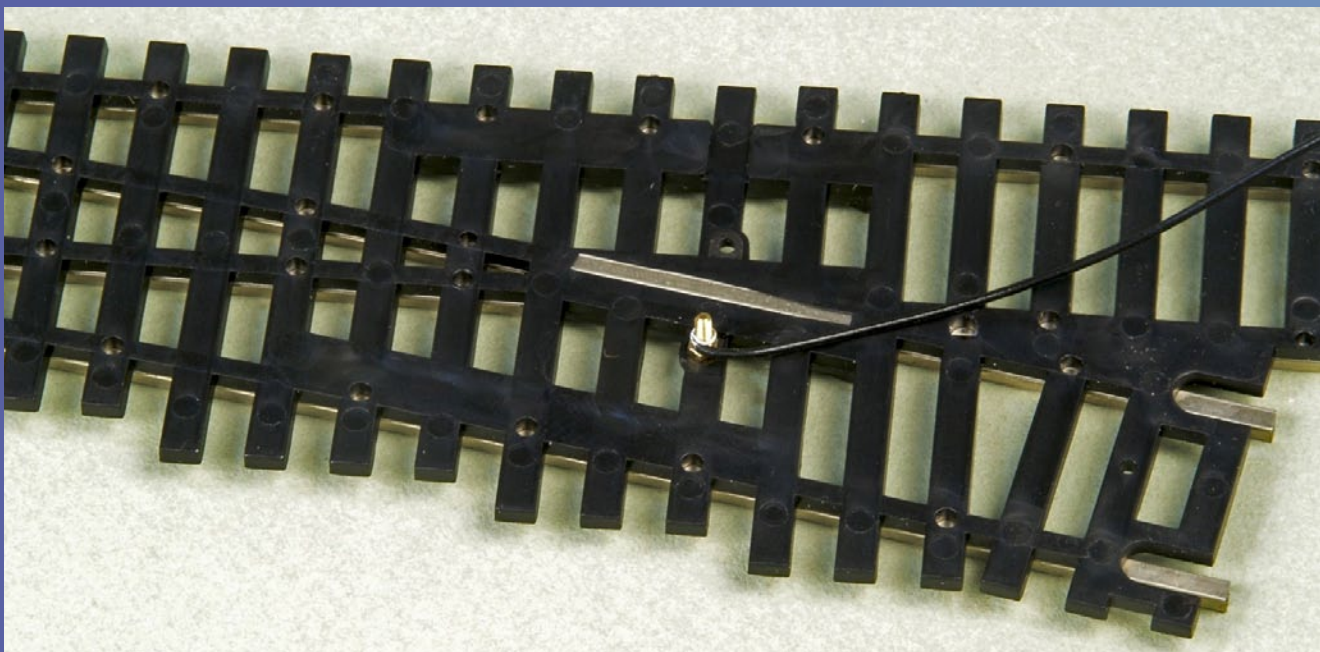
STEP 2: Turnout Preparation



First we need to prepare the turnout. We are going to power the frog of the turnout so we need to attach the wire. On many turnouts it is simple to solder a wire to the bottom of the frog. On Atlas turnouts a small brass 0-80 screw can be inserted in to the hole being pointed to by the knife-point.



I have soldered a wire to the screw in the frog and added two feeder wires to each rail. These can be small wires as they will only be a couple of inches long when finished.

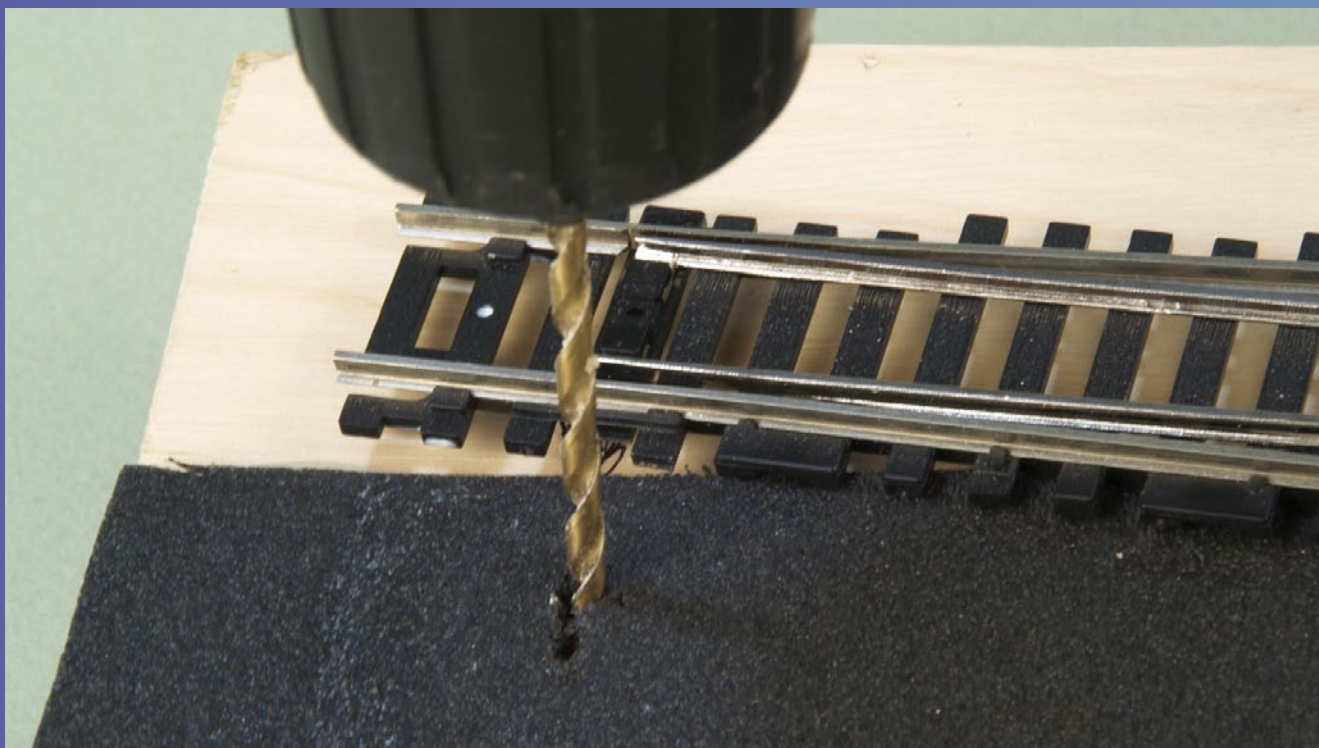


A view of the bottom of the frog after inserting the screw and wrapping a wire around it.

STEP 4: Preparation for the Servo



Drill holes for the feeder wires to poke through.



Drill a slot for the actuating wire under the throw bar. File the hole smooth to make sure the wire does not get hung up. You can use a bigger drill than I am using to make sure you have clearance.

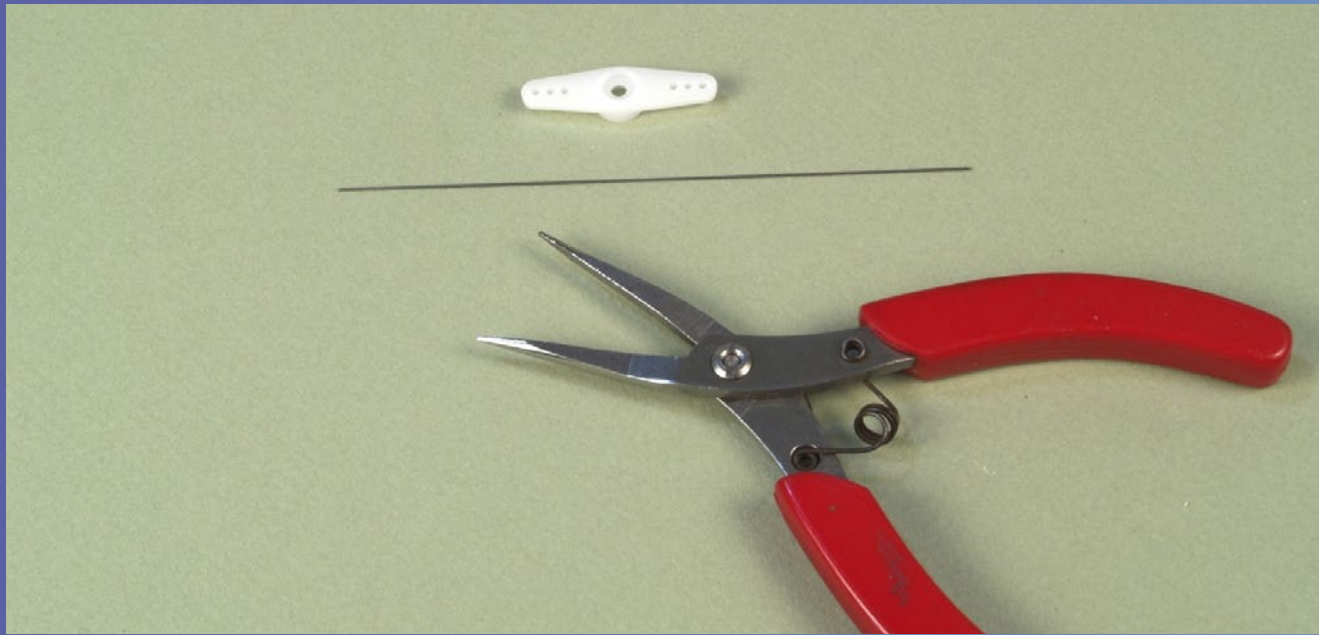


Add a bead of glue to the bottom of the switch. Notice that I have avoided getting glue near the moving points. I find the tacky glue works great for bonding the switch down and has the advantage that, if you want to remove it later, it can be softened by spraying on some water and soaking it for a few minutes to soften it. If you should accidentally glue the points, repeatedly spray on water and soak until the points move again.

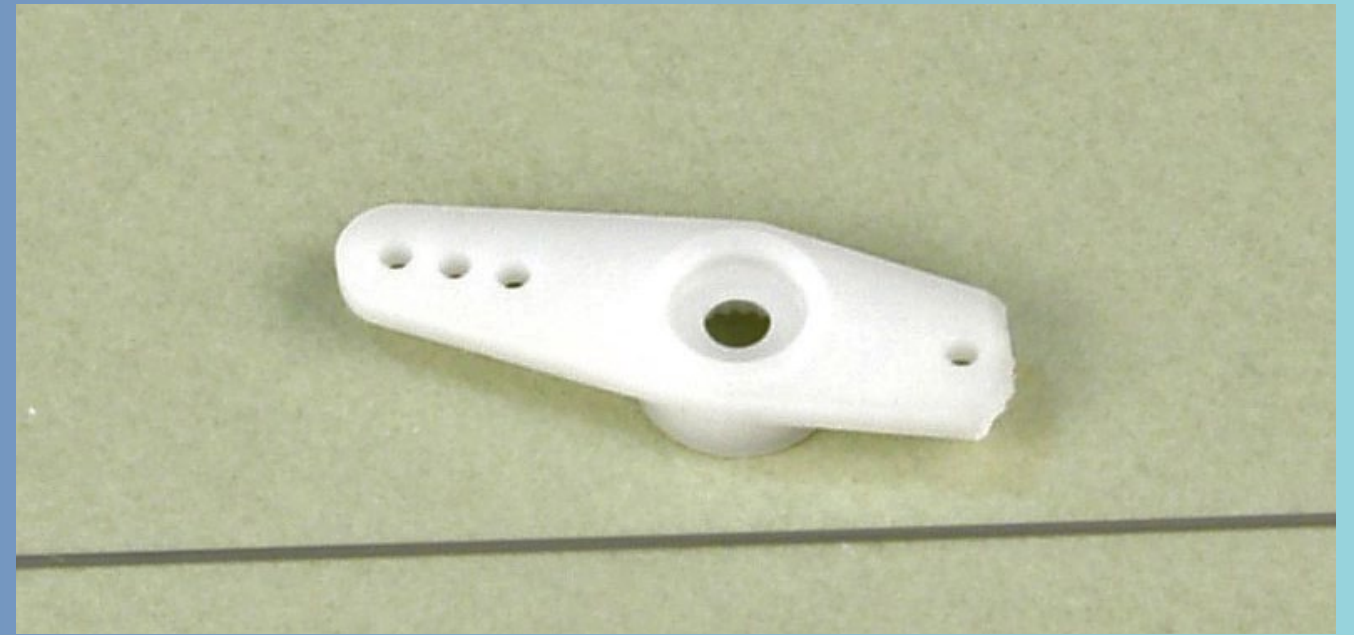


Cans make great weights for holding the turnout down flat while the glue dries. They have just the right weight to hold the track down but not crush the foam roadbed. Making sure the turnout is absolutely flat will greatly increase its reliability.

STEP 5: Preparing the Servo Horn



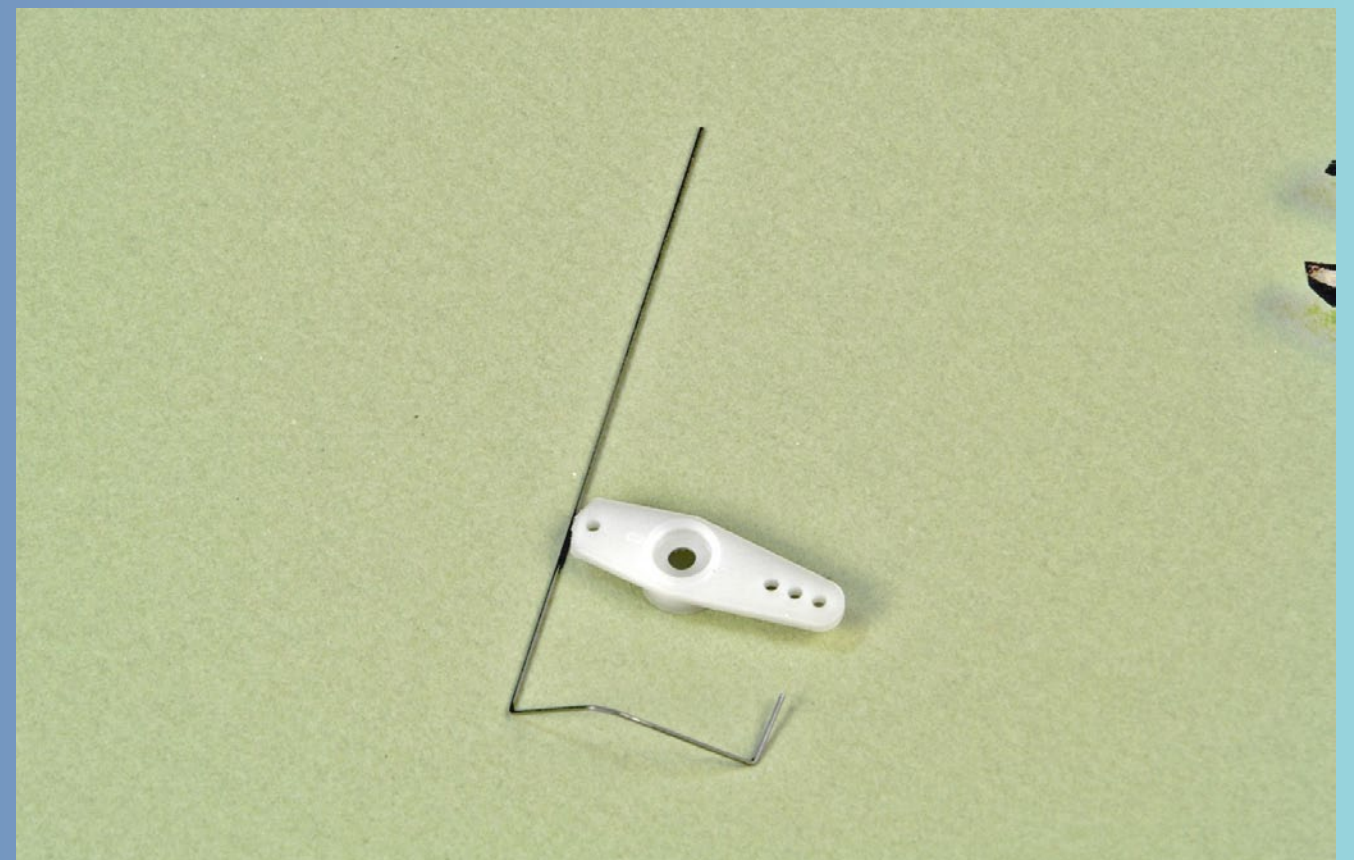
While the glue on the turnout is drying the servo can be prepared. This is the servo arm I like to use and a piece of .025" wire. Avoid using thicker wire as the springiness of the thinner wire makes the installation a lot less critical and prevents the servo from stalling and drawing too much current. For solid point turnouts, however, .032-.047 wire is needed.



The horn should look like this after trimming.



One end of the servo arm is shortened by cutting it off with diagonal pliers to give it sufficient clearance. Be certain not to cut the last hole.



Bend the wire as shown.

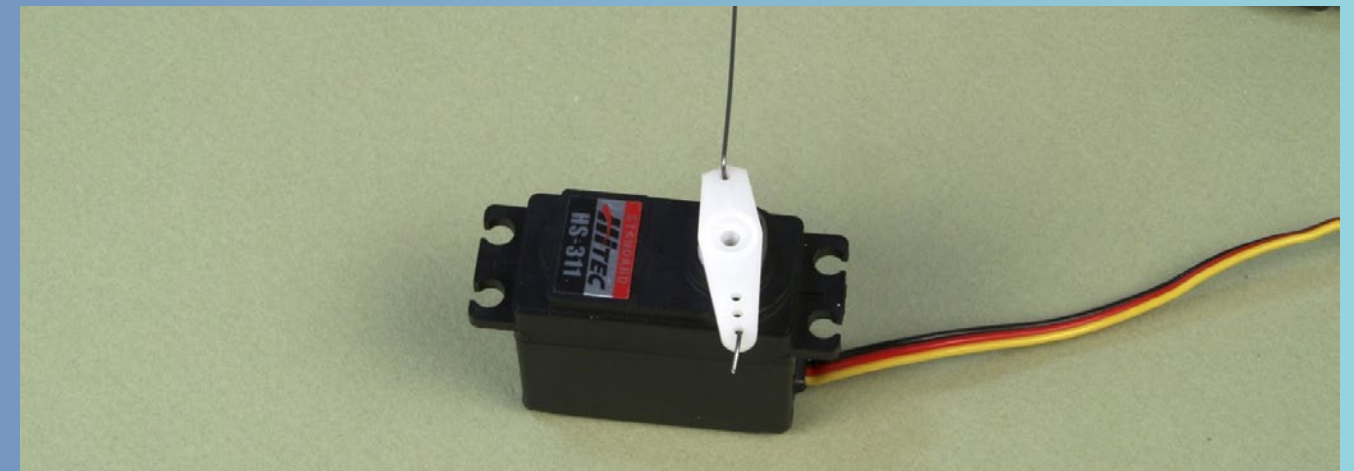
STEP 5: Preparation of the Servo Horn Continued



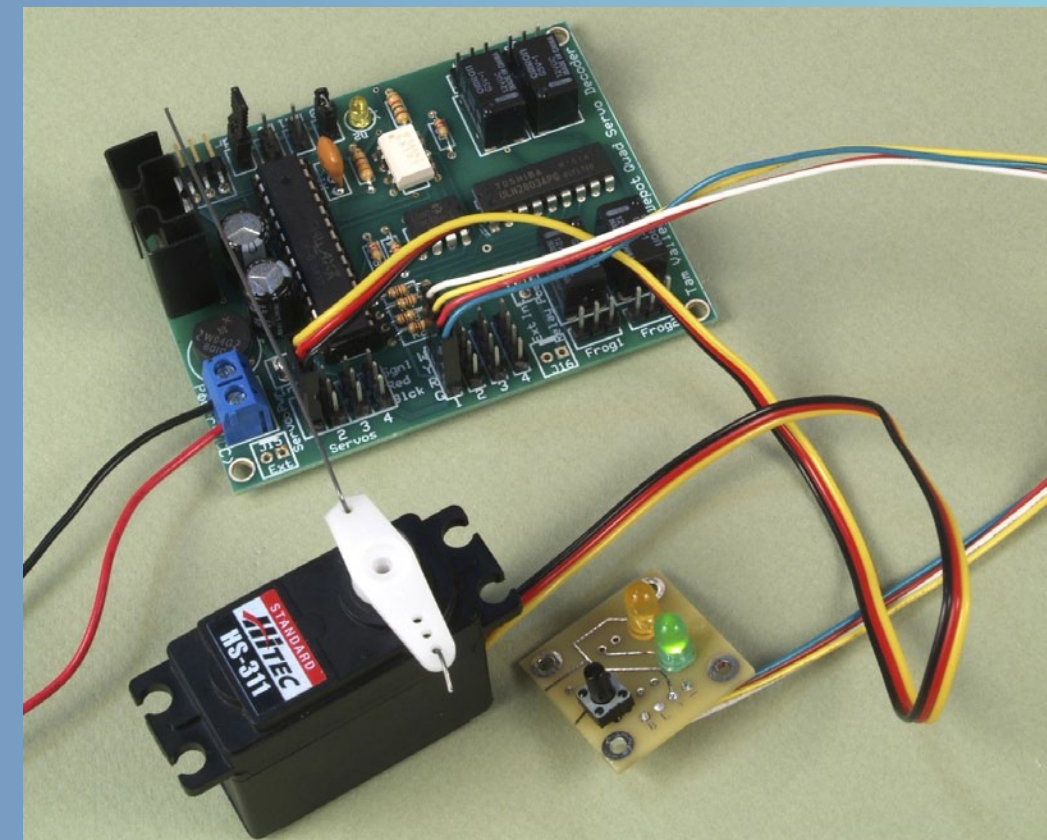
Put the wire through the holes like this.



Bend the 2 ends down like this. The wire will now stay on and it won't interfere with the mounting hole. Note that there are little set screw-based devices made for attaching wire to servos but these are normally best avoided. The screws will work themselves loose over time and disaster will follow.

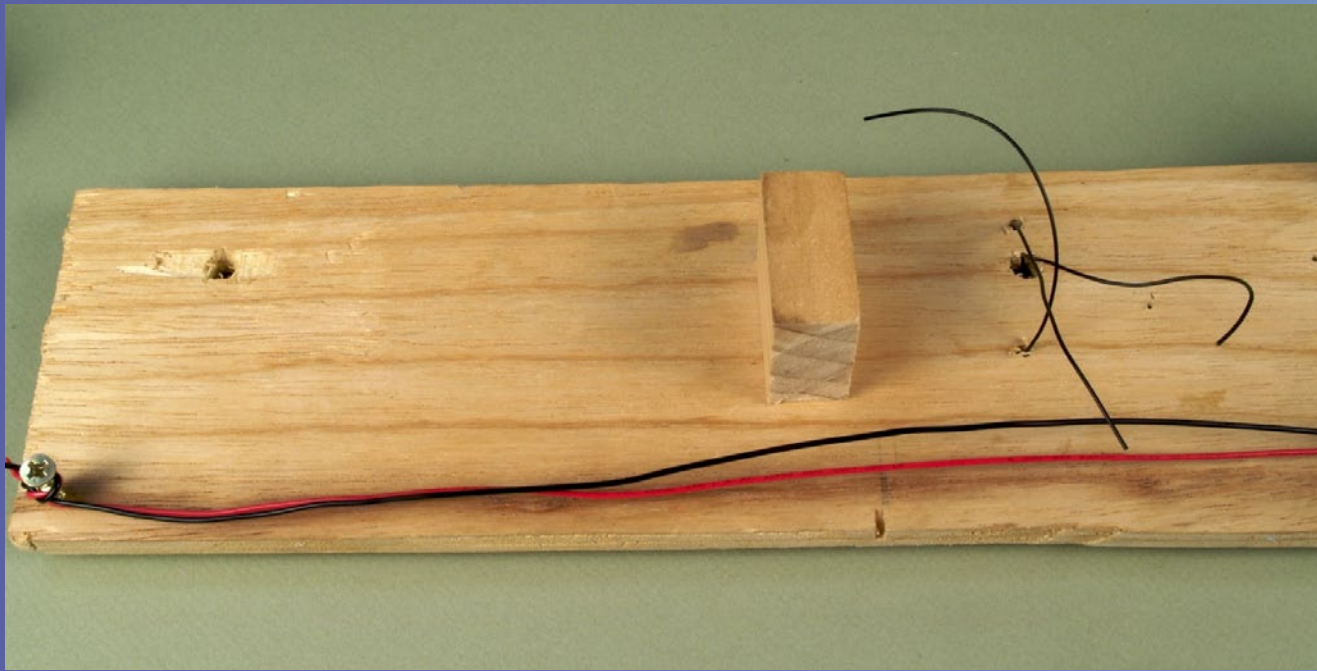


Place the horn on the servo. Leave off the center screw that secures the arm for now. This will let us fine-tune the arm position.

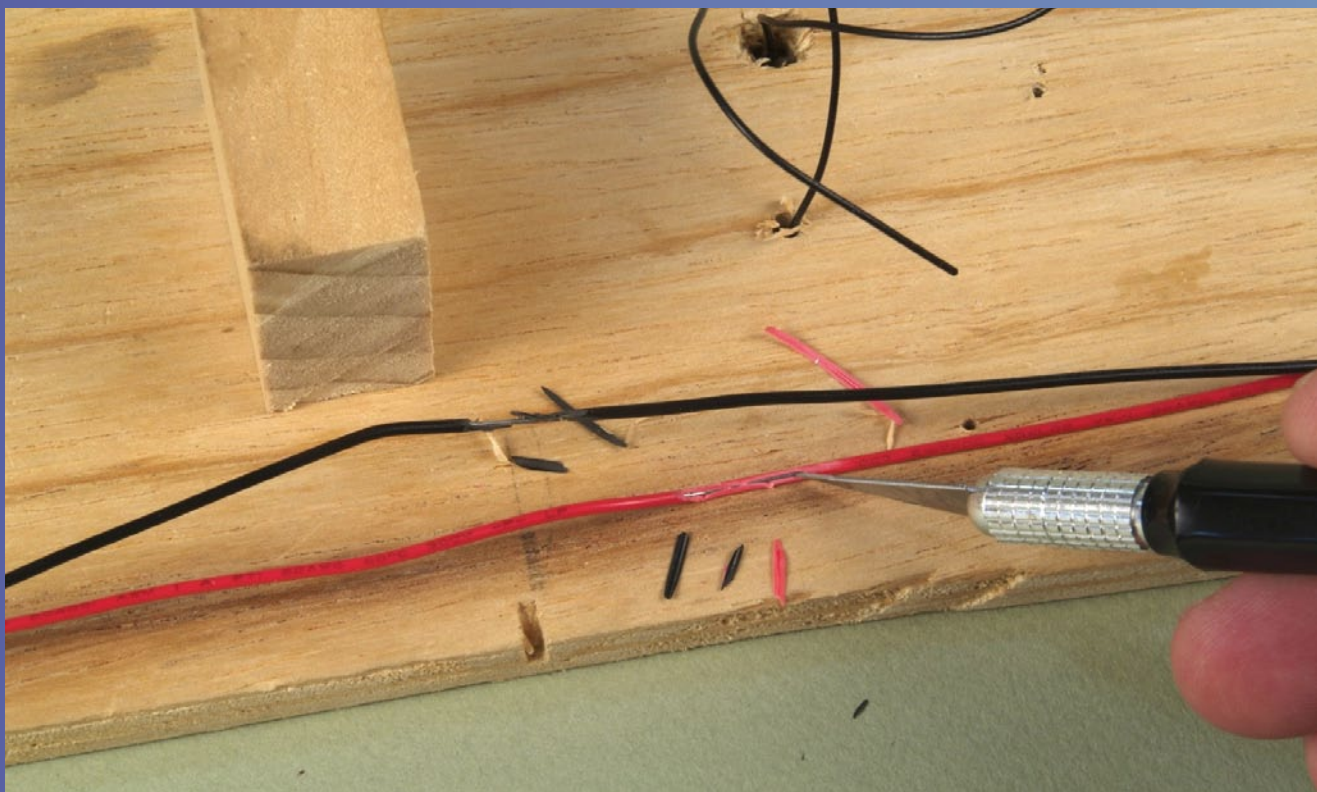


I have attached the servo to the control board and powered it up by connecting it to the track so that I can test the servo and center the arm. Now is a good time to take note of how the servo moves for each position, closed (straight-through) and thrown. We can mount the servo in 2 ways, one of which will have the default closed and thrown correct. In the other, the turnout is turned around 180 degrees on the axis of the actuator wire, with the throw reversed. Obviously, the former is better. However, we can reverse it with the software later if needed if, for example, something gets in the way of one of the positions.

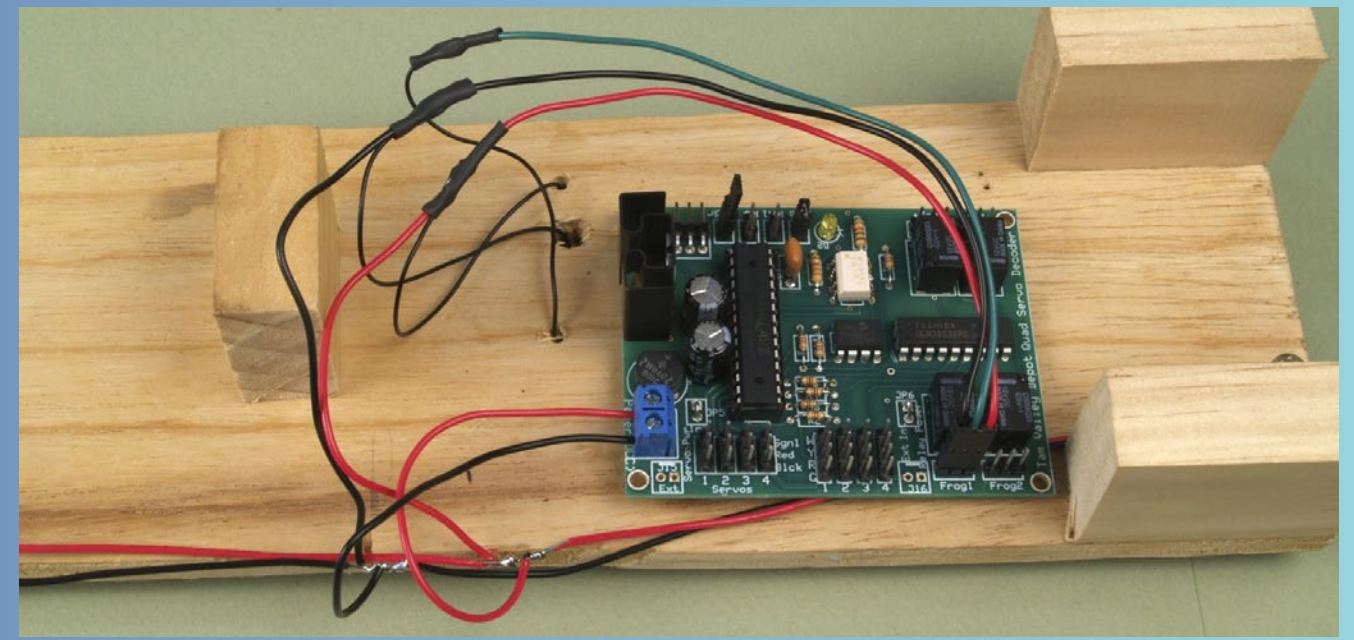
STEP 6: Attaching the Servo to the Subroadbed



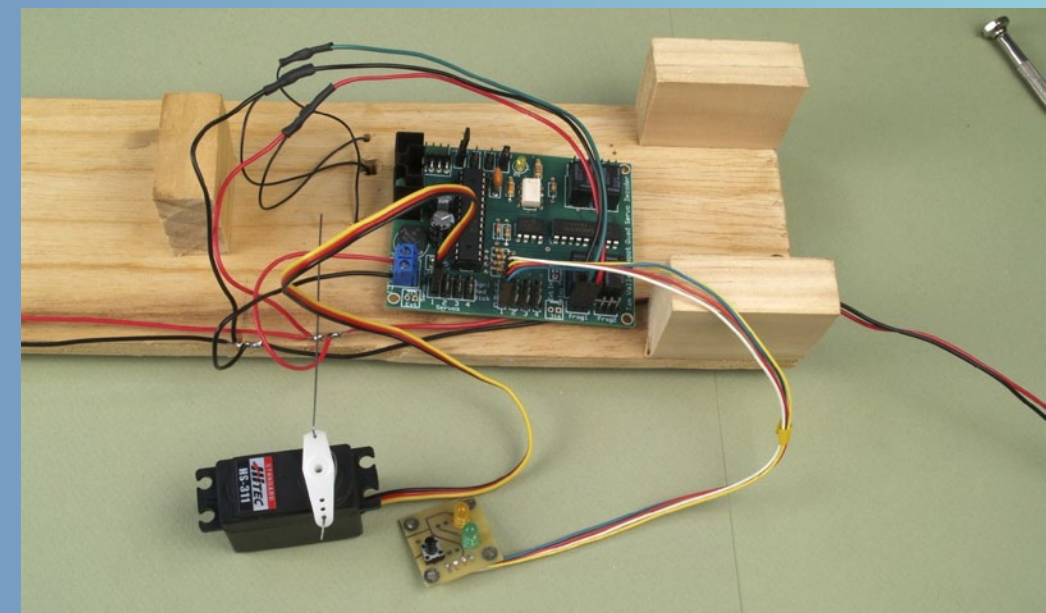
Back to the turnout. Here I show the under-side with the hole under the throw-bar on the left, The three feeder wires are on the right. Stretching across the bottom is the DCC track bus.



Using a hobby knife I have stripped some insulation for attaching some feeder wires. Note that I have offset the stripping on the two wires so that they will not short if touched together.

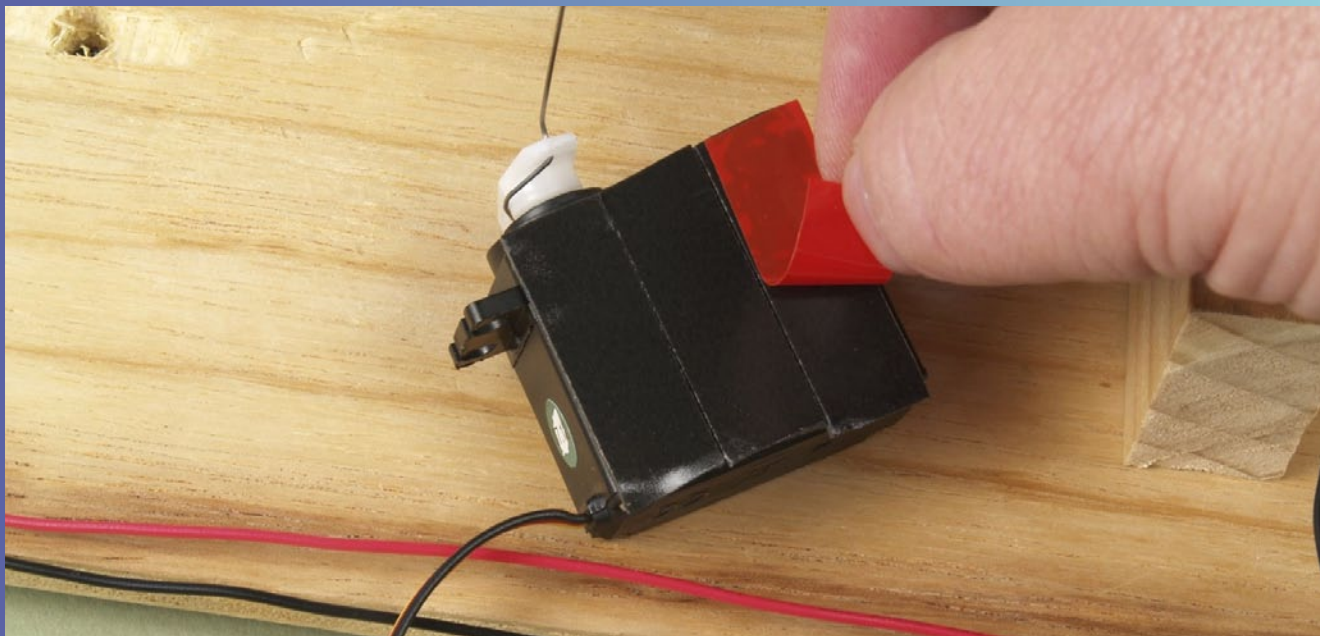


The decoder board is in place along with feeder wires to both power it and transmit the DCC signal. The turnout feeder wires have been soldered in and the frog powering circuit has been wired and attached to the board. I have not bothered to figure out the correct polarity for the frog circuit – we will do that later after the servo is in place.

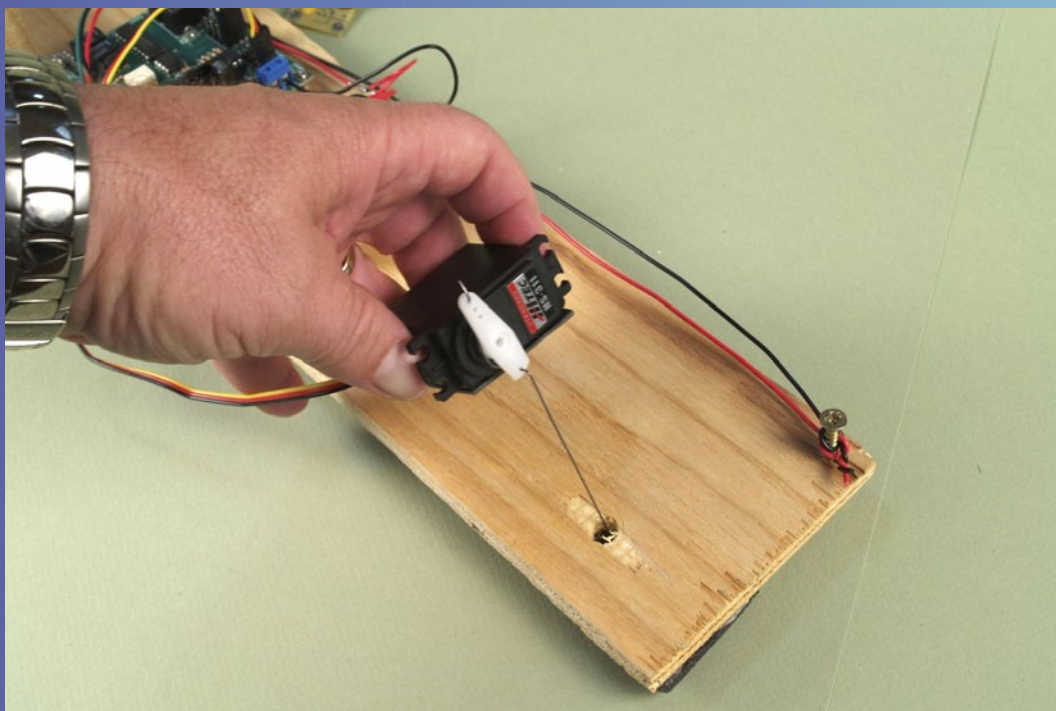


I have plugged in the servo and attached the fascia controller. Now is the time to center the servo. On the Quad we can center a servo by placing a jumper on the Addr pins and then pushing the button on the fascia controller. On the Octopus there is a jumper marked Cntr. You can also center servos by moving the arm to both ends of the movement and guesstimating the center. Be careful when pushing the arm to do it slowly so as not to hurt the output gears. I have moved the arm on the mounting sprocket so that it is roughly at 90 degrees to the flat side of the servo.

STEP 6: Attaching the Servo to the Subroadbed *Continued*



I have attached a layer of double-sided tape after cleaning the plastic of the servo with rubbing alcohol to increase the tape adhesion.

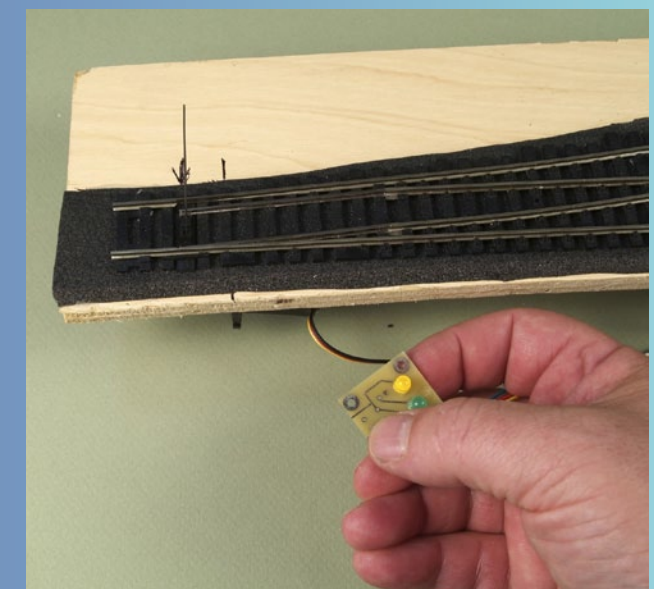
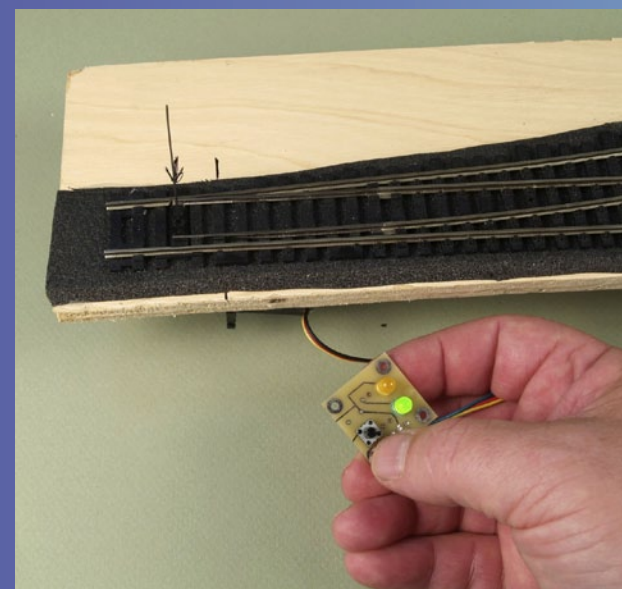


The servo is now attached to the subroadbed. You can clean the plywood surface of dust and loose particles with a piece of blue masking tape. Just stick it on and remove it a few times to pick up the loose particles. Push the wire through the hole and through the hole in the throw-bar. This is by far the trickiest bit in the whole procedure. If the layout can't be turned upside down, a small mirror can be used to aid this procedure by angling it so you can see up the hole and position the wire.

STEP 7: Attaching the Servo to the Roadbed

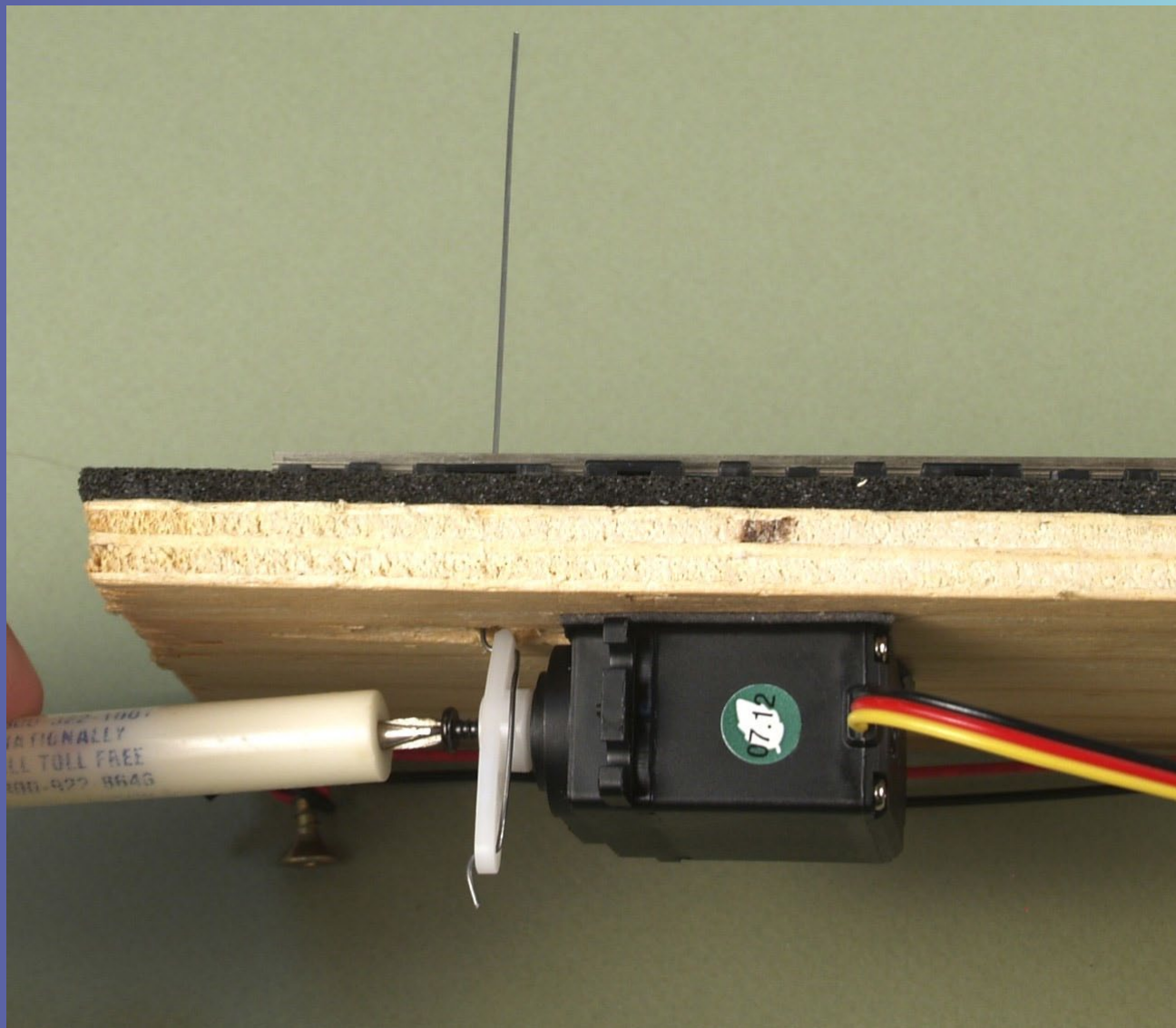


Before attaching the servo to the roadbed move it around so that the points are in the middle. Now push up firmly on the servo to seat it.



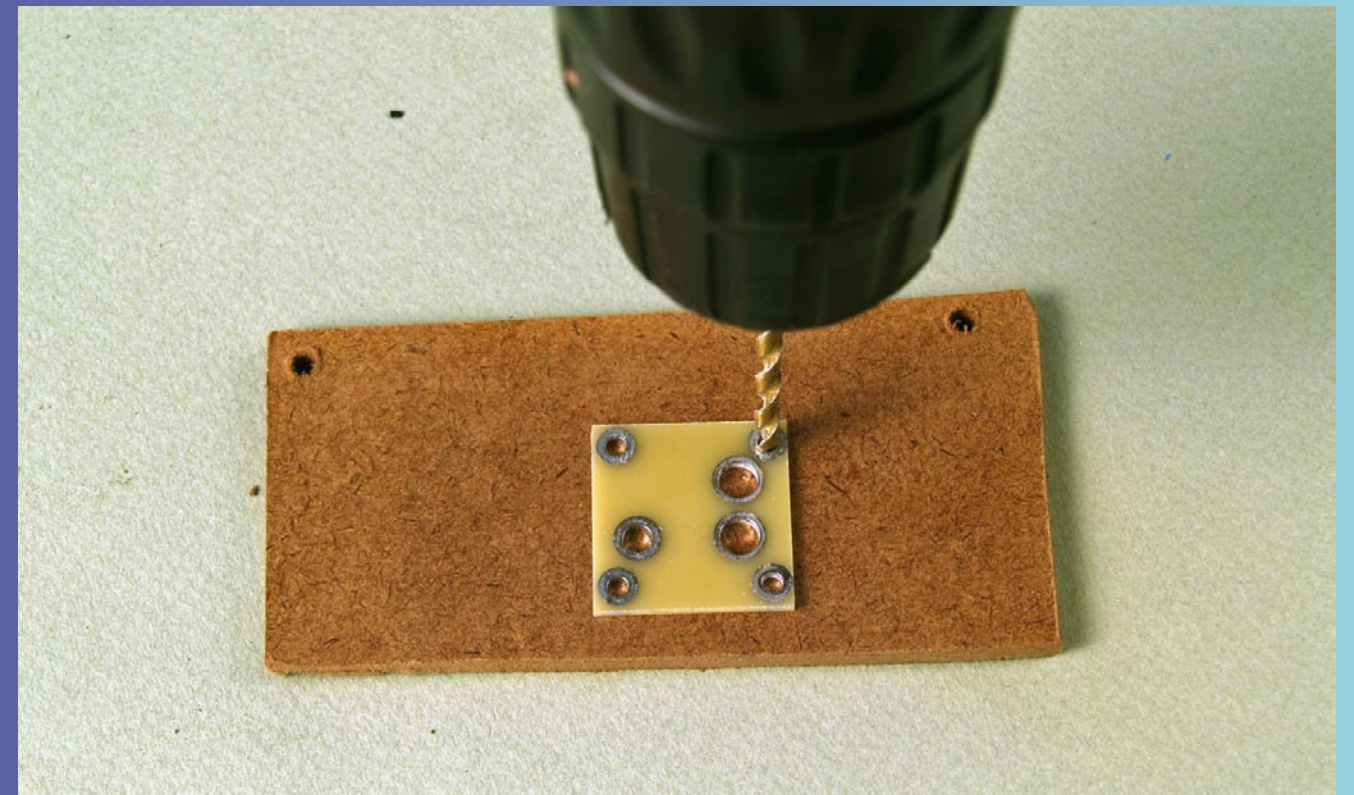
I have removed the centering jumper from the Quad and am testing the throw of the turnout. If the points don't seat firmly it may be necessary to increase the range of the throw. The Quad as it comes with no jumpers should work just right on an HO turnout or any turnout with about the same amount of throw. Less throw may be needed for N scale, which is done by adding a jumper across pins R0 on the Quad.

STEP 7: Attaching the Servo to the Roadbed *Continued*

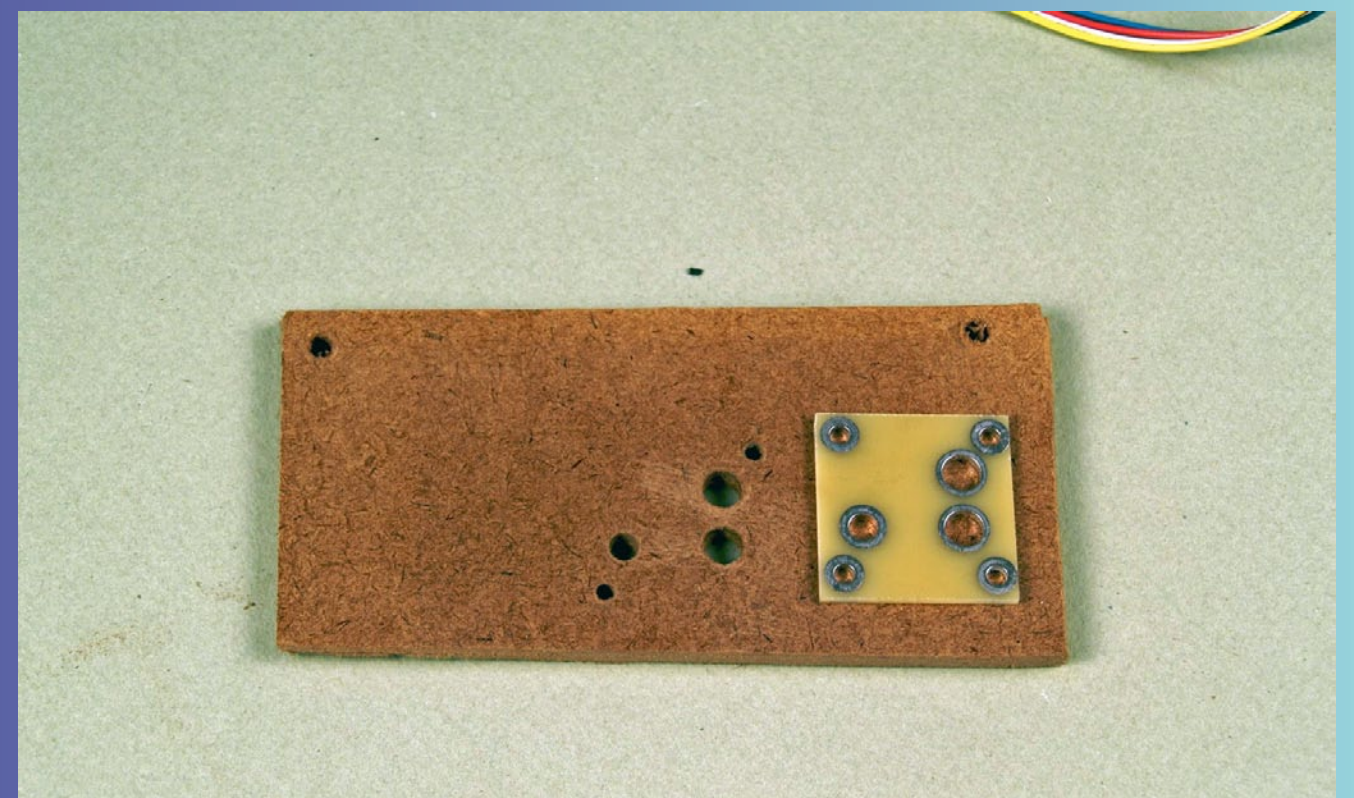


I am attaching the screw to the servo arm now that it is in place to keep the arm from working its way off. You can also see how the servo is mounted to the bottom of the roadbed. You can also see why we trimmed the servo arm shorter – it just barely clears the bottom of the roadbed. If desired you can add brackets at this point to more firmly mount the turnouts. Small blocks of wood can be used or small L-brackets. However, I highly recommend at least placing the turnout with the double-sided tape as it is easier to position it this way and then add bracing later.

STEP 8: Mounting the Fascia Controller

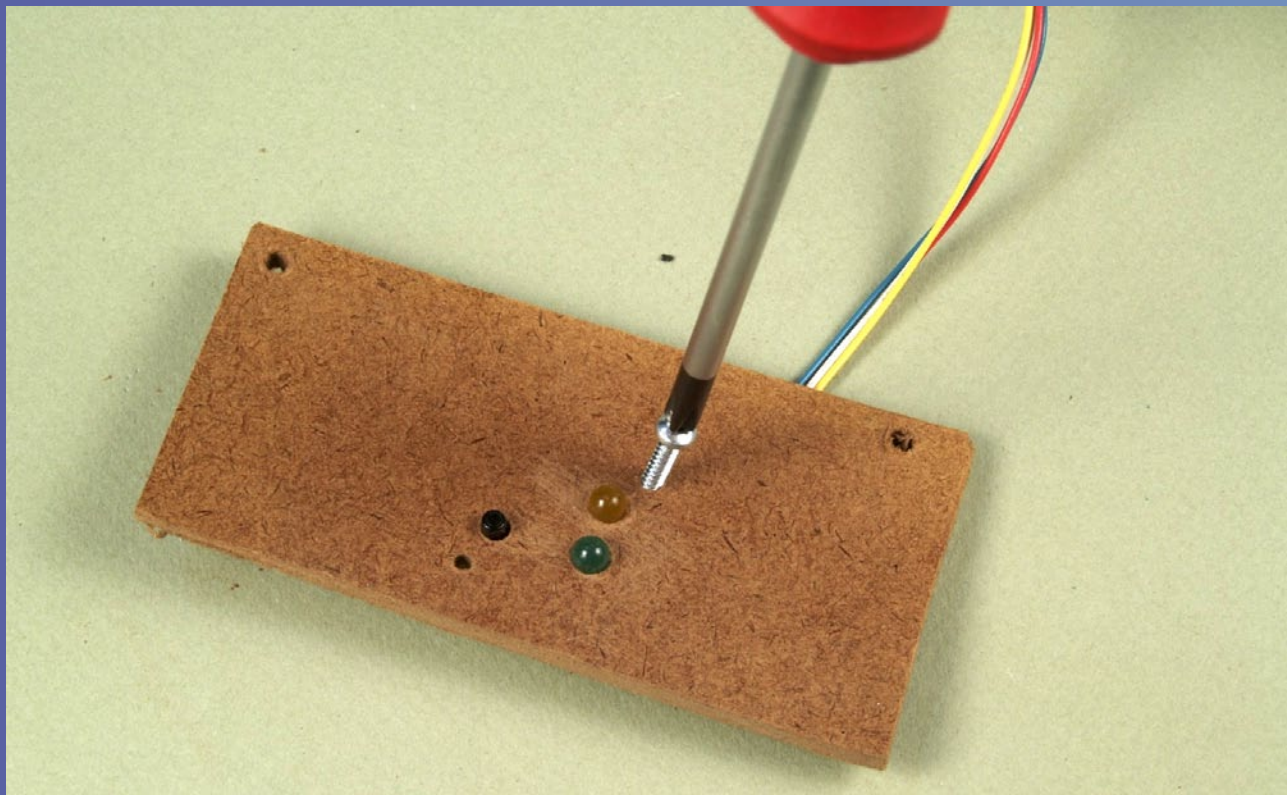


I am now going to mount the fascia controller on a small piece of hardboard to simulate a fascia. I am using the drilling template that comes with the fascia controllers to guide the placement of the holes.

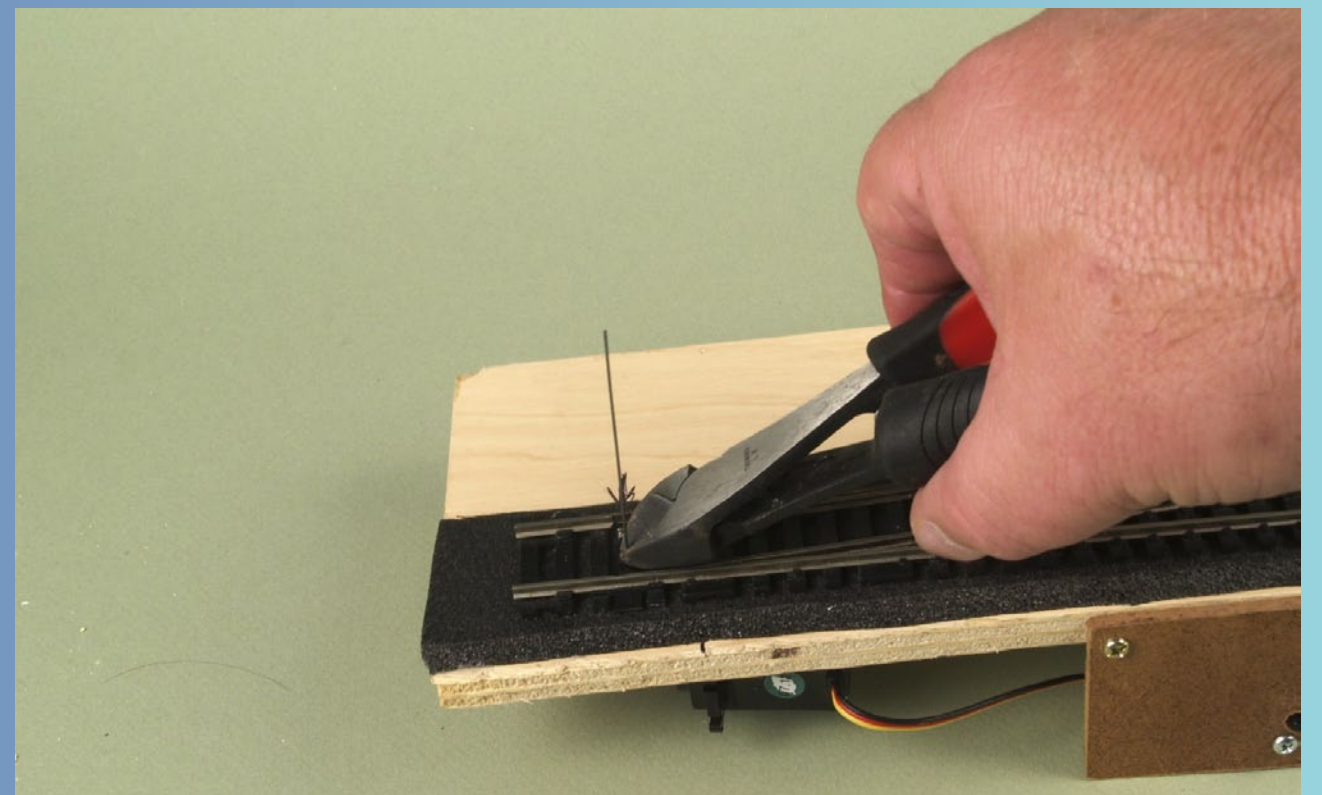


The holes are done and ready for the controller.

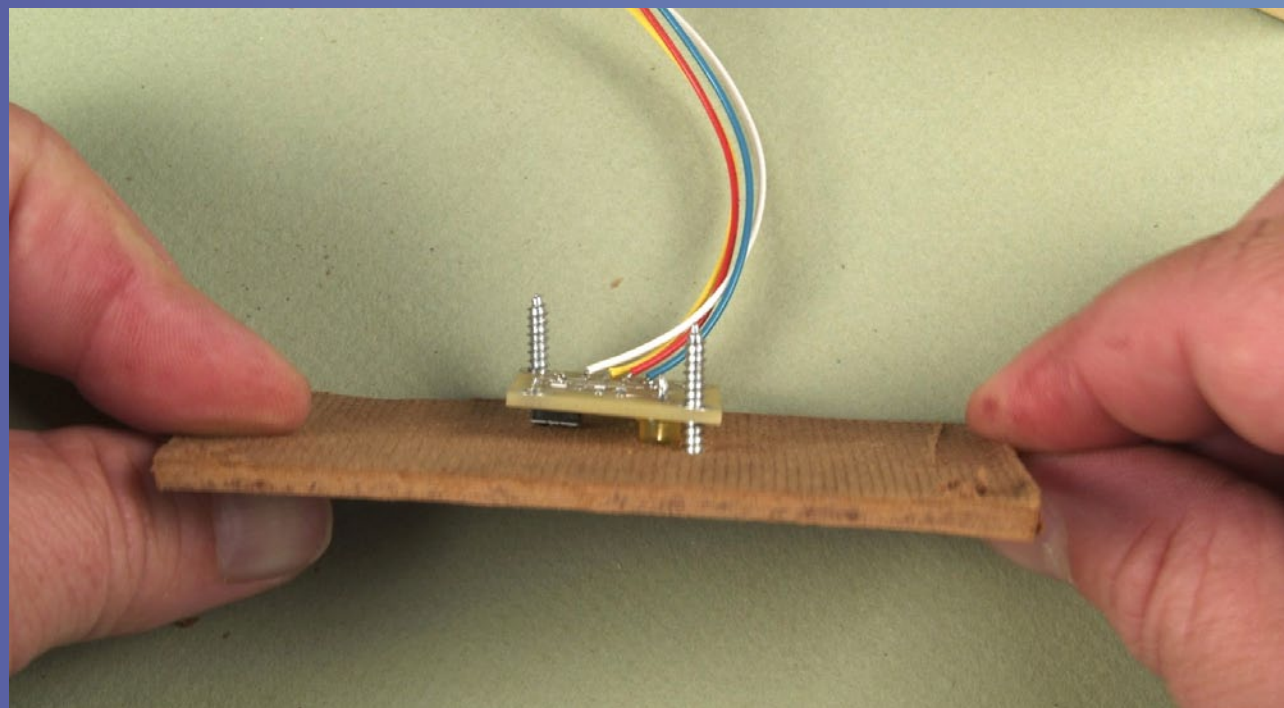
STEP 8: Mounting the Facia Controller *Continued*



The holes are sized for #4 sheet metal screws. The soft metal lining the mounting holes on the PC board makes a perfect material for tapping the screws into.

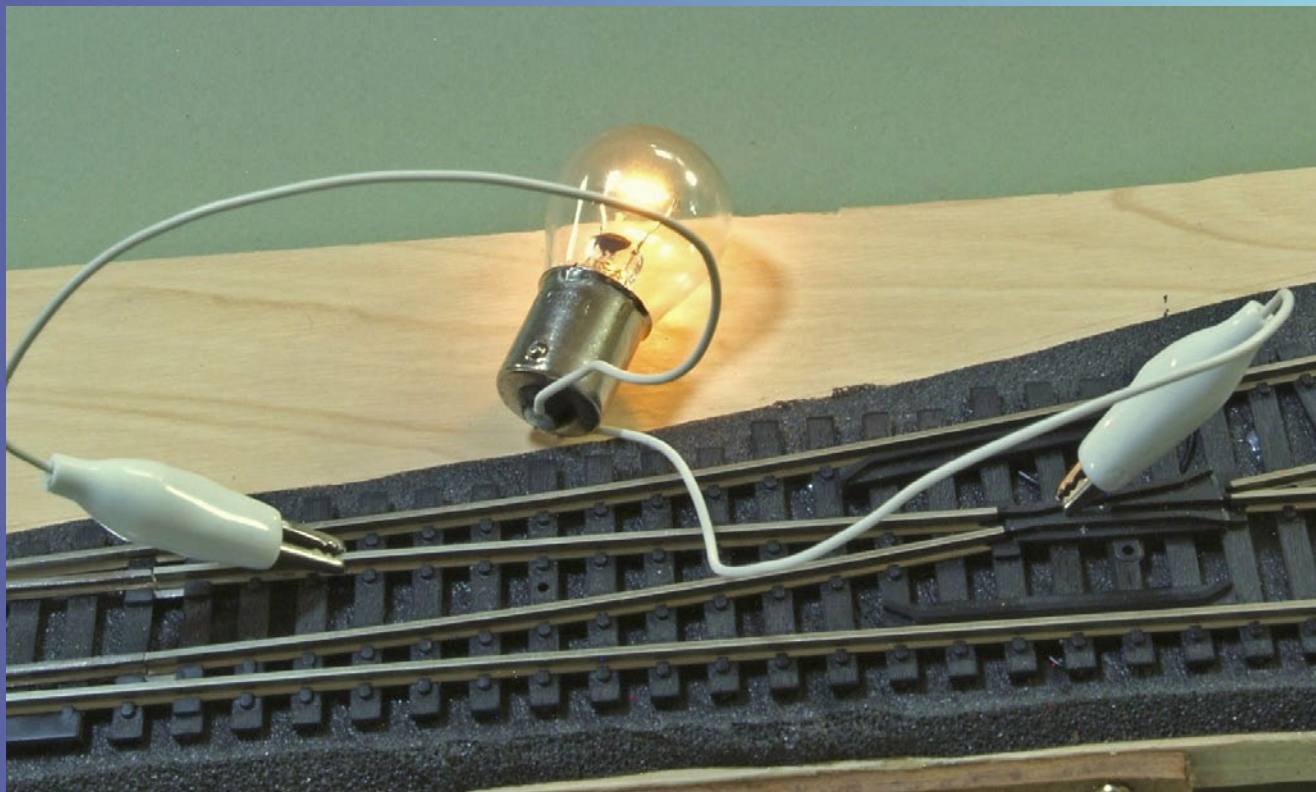


The final step is to trim off the actuator wire.

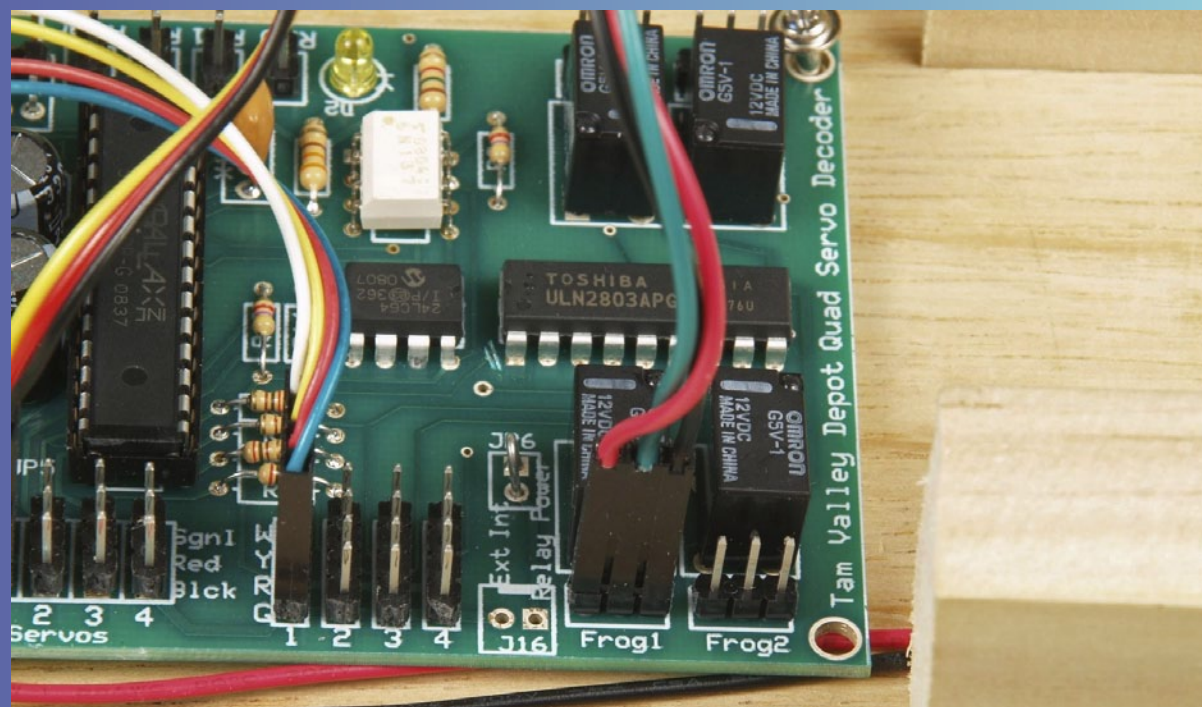


A side view showing how the screws are holding the controller in place. Don't over-tighten the screws and crush the PC board!

STEP 9: Testing the Device

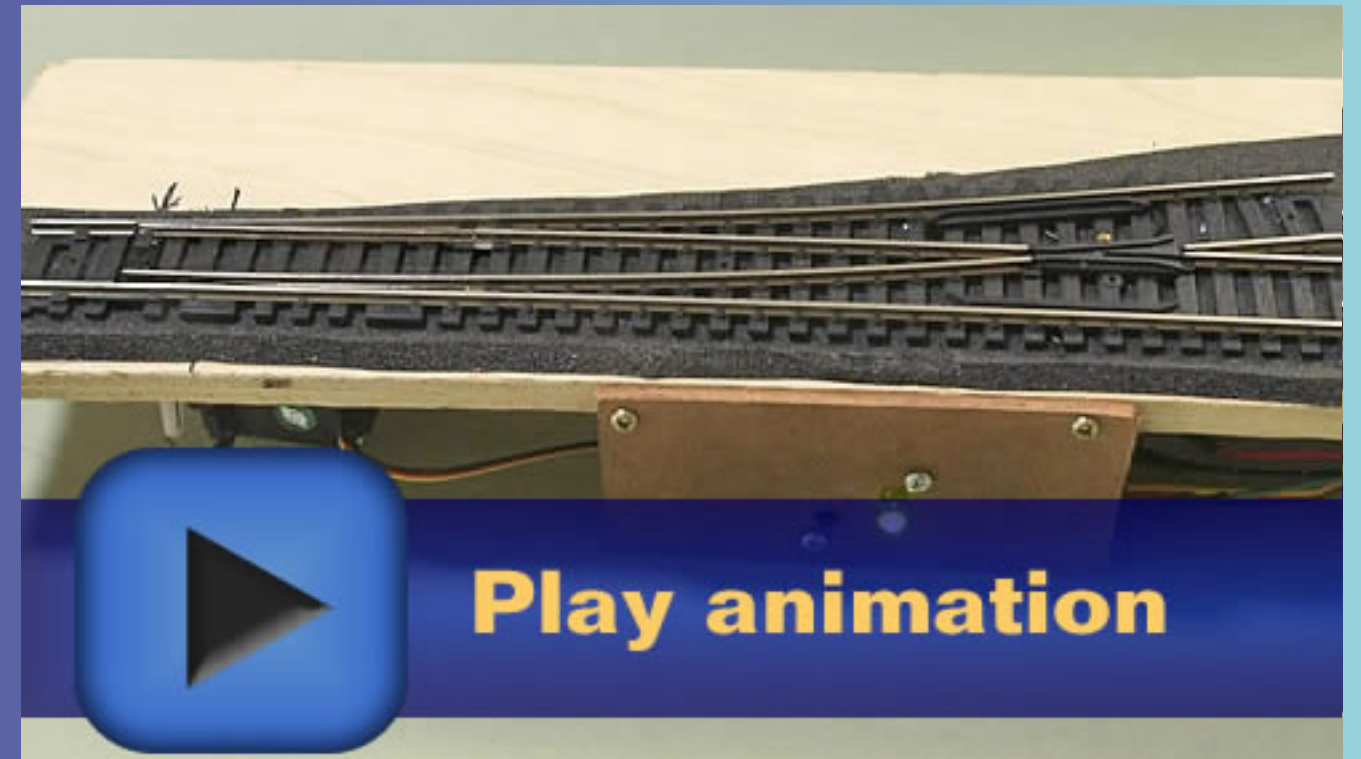


I am using a 12V automobile light bulb to test the frog circuitry. The turnout is in the closed position and the frog should be at the same potential as the closed rail. However, as you can see, the frog is connected to the wrong rail as the light bulb has lit, indicating a short.



The problem is easily corrected by swapping the 3-way plug of the frog connector on the Quad the other way around. Now the light bulb stays dark as it should.

STEP 10: Final Installation



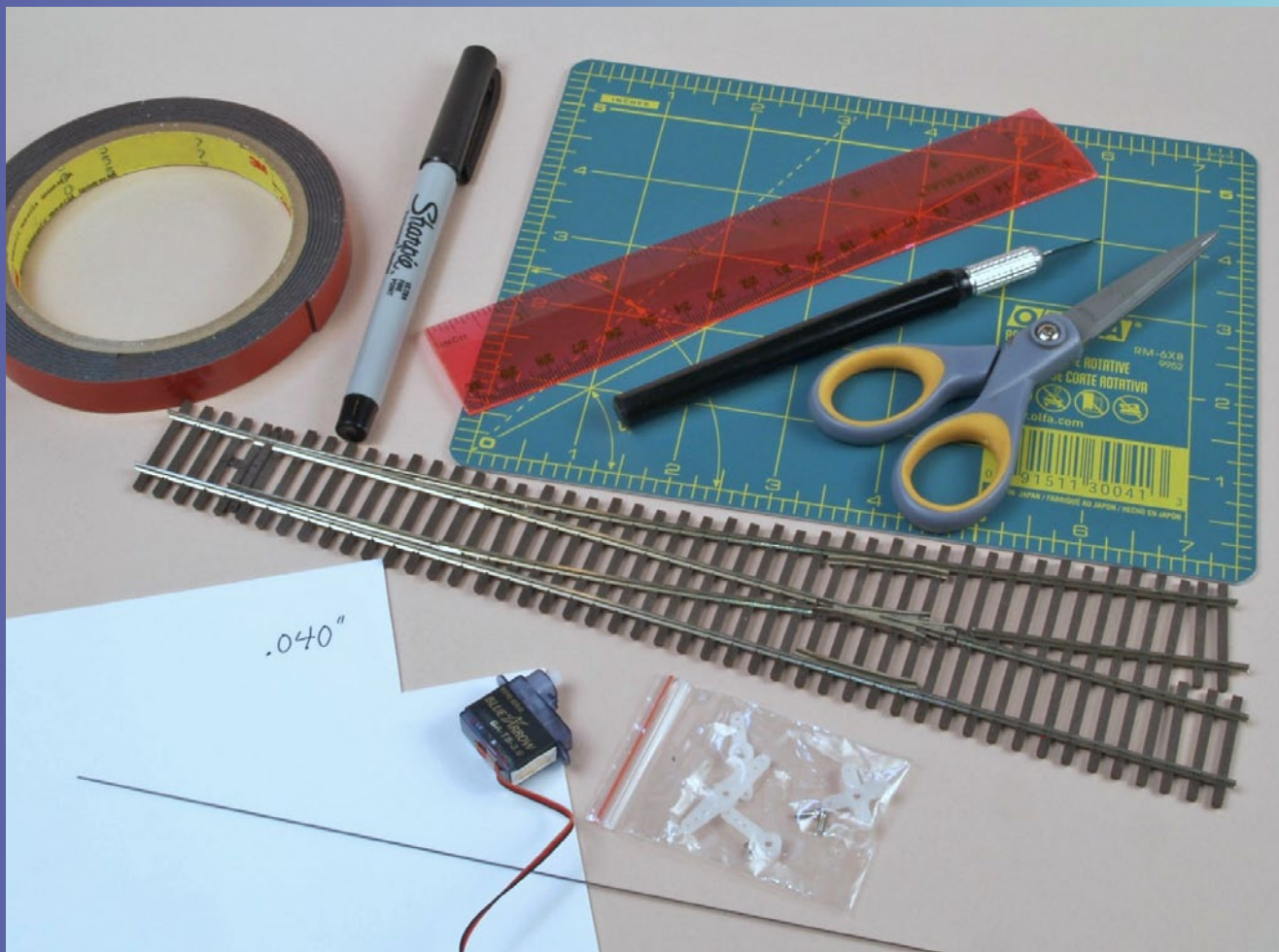
The final installation. It goes a lot faster than reading these detailed steps would have you think.



The final installation viewed from the end. You can clearly see how the servo arm moves the points.

Installing a Micro Servo Directly to the Bottom of a Turnout

STEP 1: Parts Needed

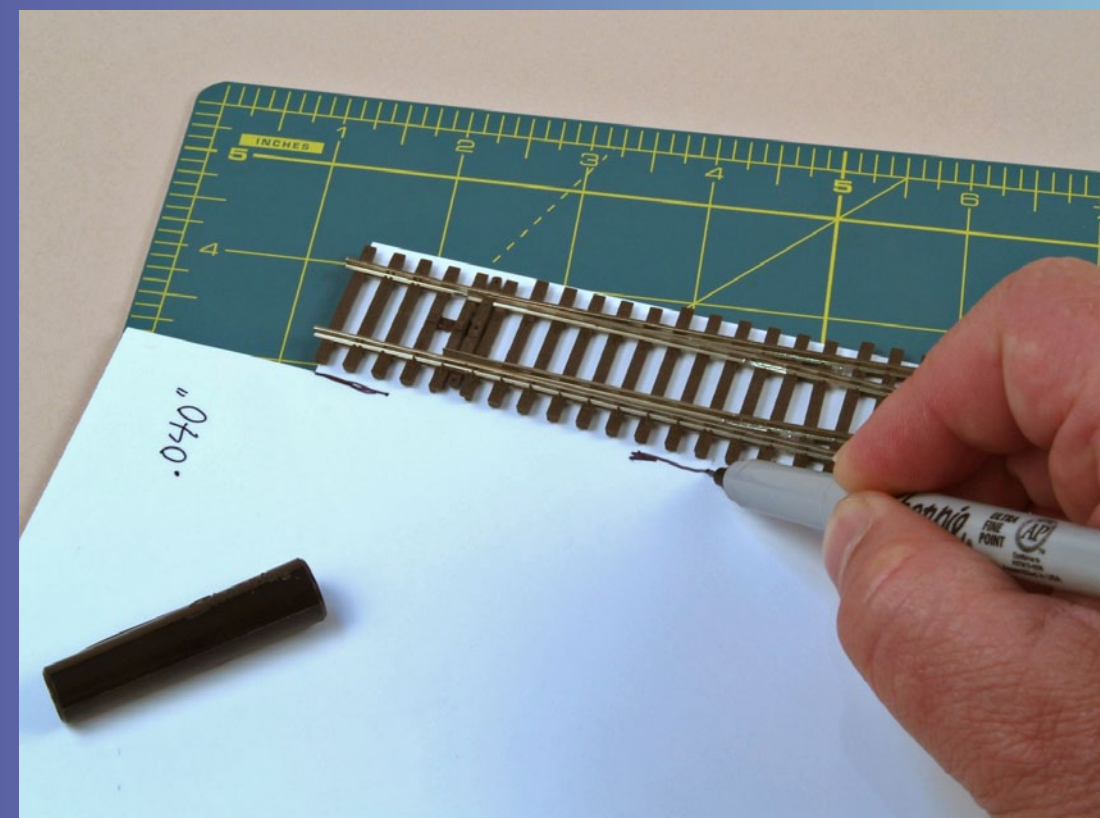


Parts needed: a turnout, a Micro Engineering code 83 #6 is pictured, .040" thick styrene for the mounting base, a micro-servo (other sizes will also work) and servo parts, a piece of .020" thick music/spring wire (K&S metal center), double-sided foam mounting tape, a pen for marking, cutting board, straight-edge, and scissors.

STEP 2: Preparing for the Actuator Wire

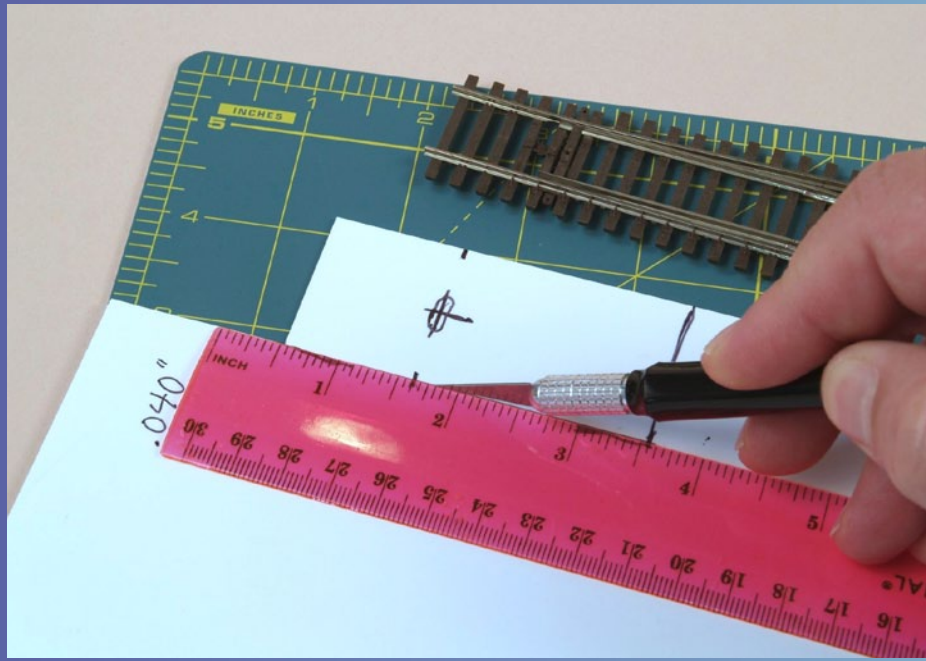


The micro-engineering turnout has a small hole in the middle of the throw-bar that will be used for the actuating wire. If there isn't a hole in your turnout then drill one with a small drill a little larger than the wire.

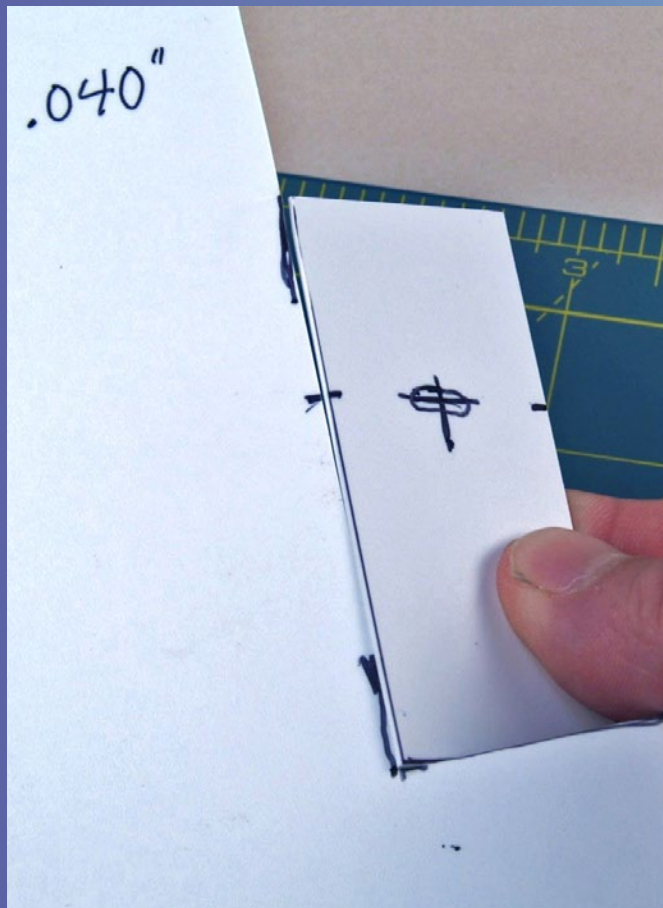


Marking the styrene to cut. I like to make it a little larger than the ties.

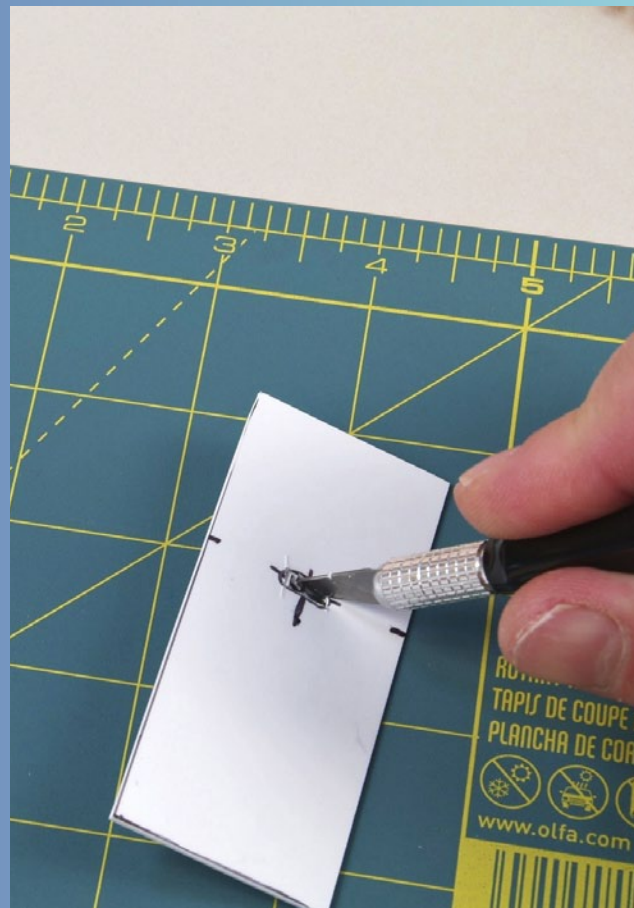
STEP 2: Preparing for the Actuator Wire Continued



Note that I have marked the area under the points directly beneath the hole in the throw bar. We will cut a slot here for the actuating wire. Using a straightedge, score the styrene with a sharp knife.

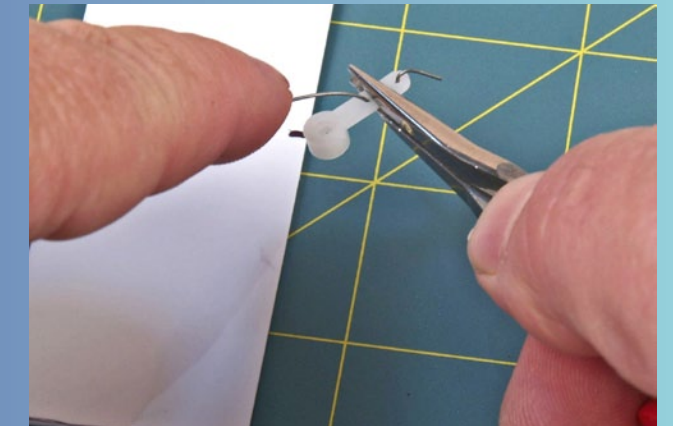
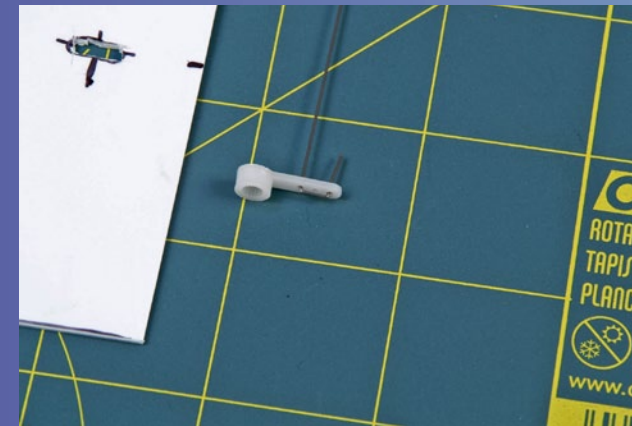
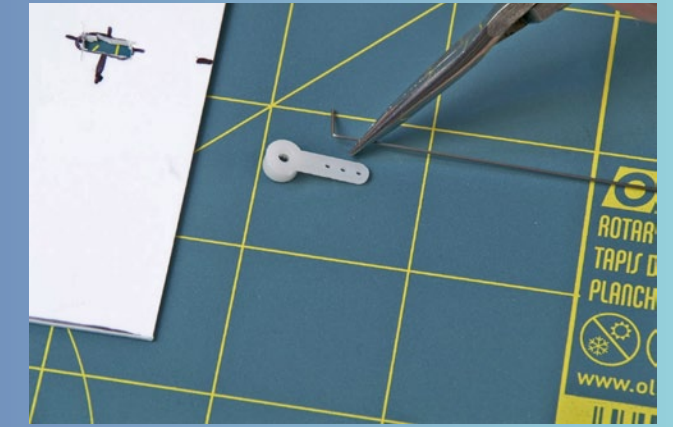
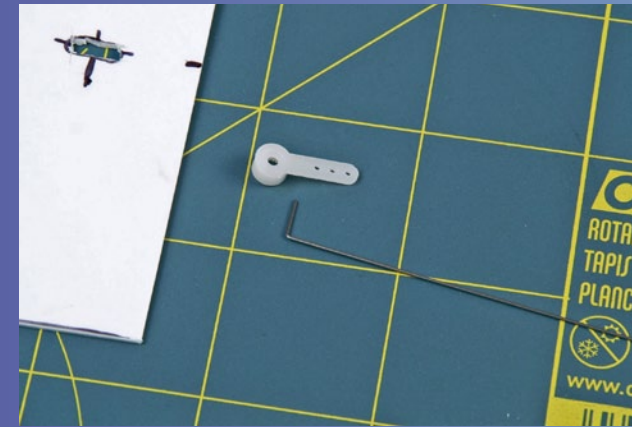


Snap the styrene along the scored lines to break off the piece.

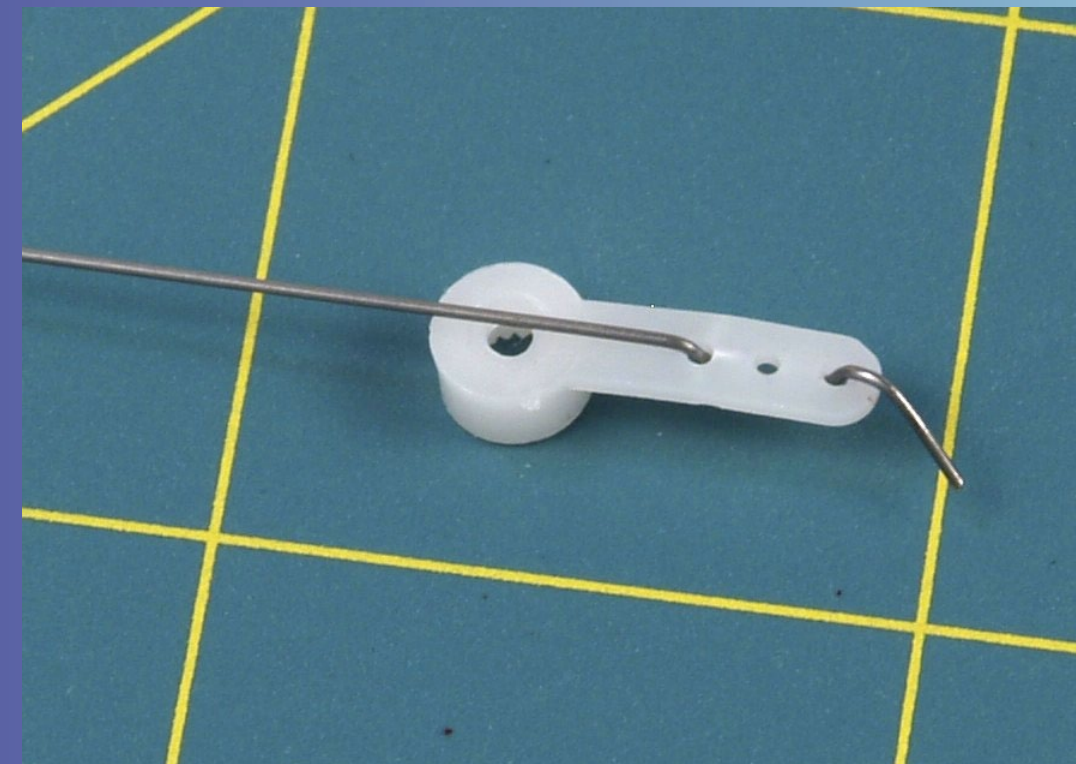


Cut out the slot - no need to be elegant - just a rough cut is fine.

STEP 2: Preparing for the Actuator Wire Continued

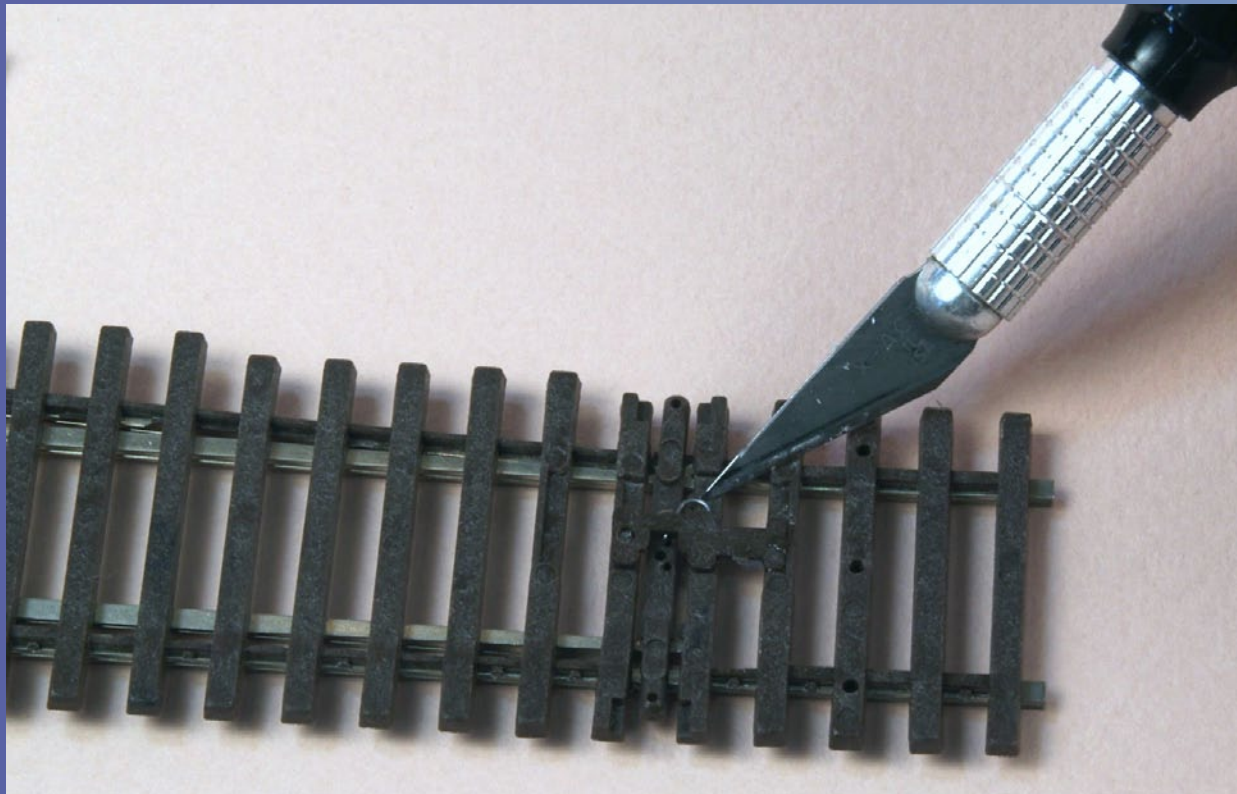


Bend the wire as in the pictures above show.

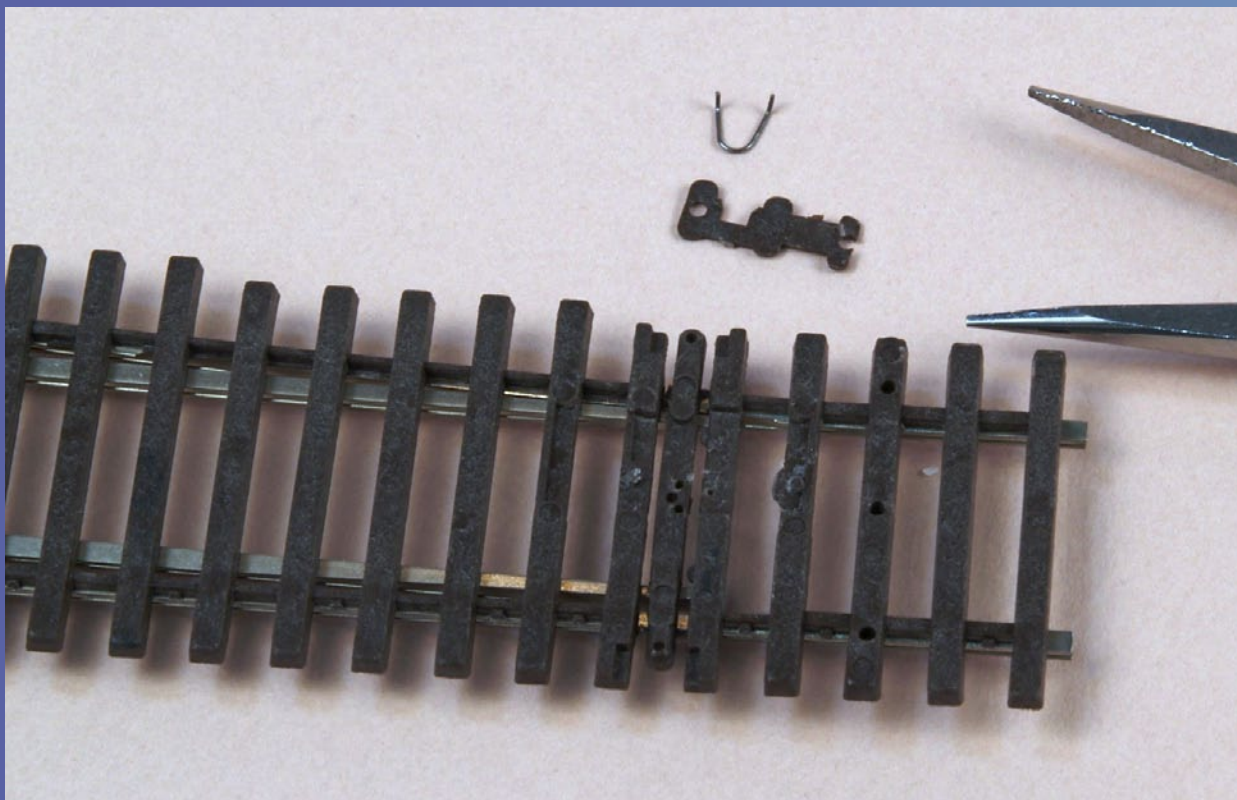


Close-up of the final bend.

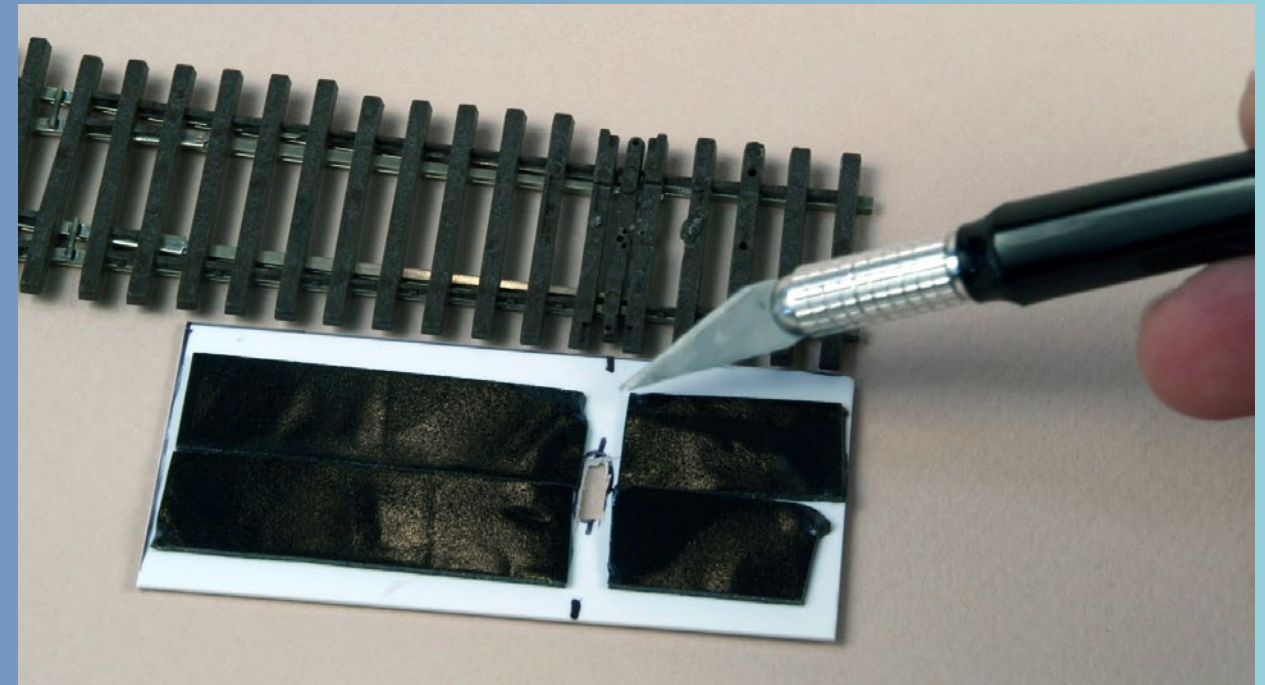
STEP 3: Preparing the Turnout



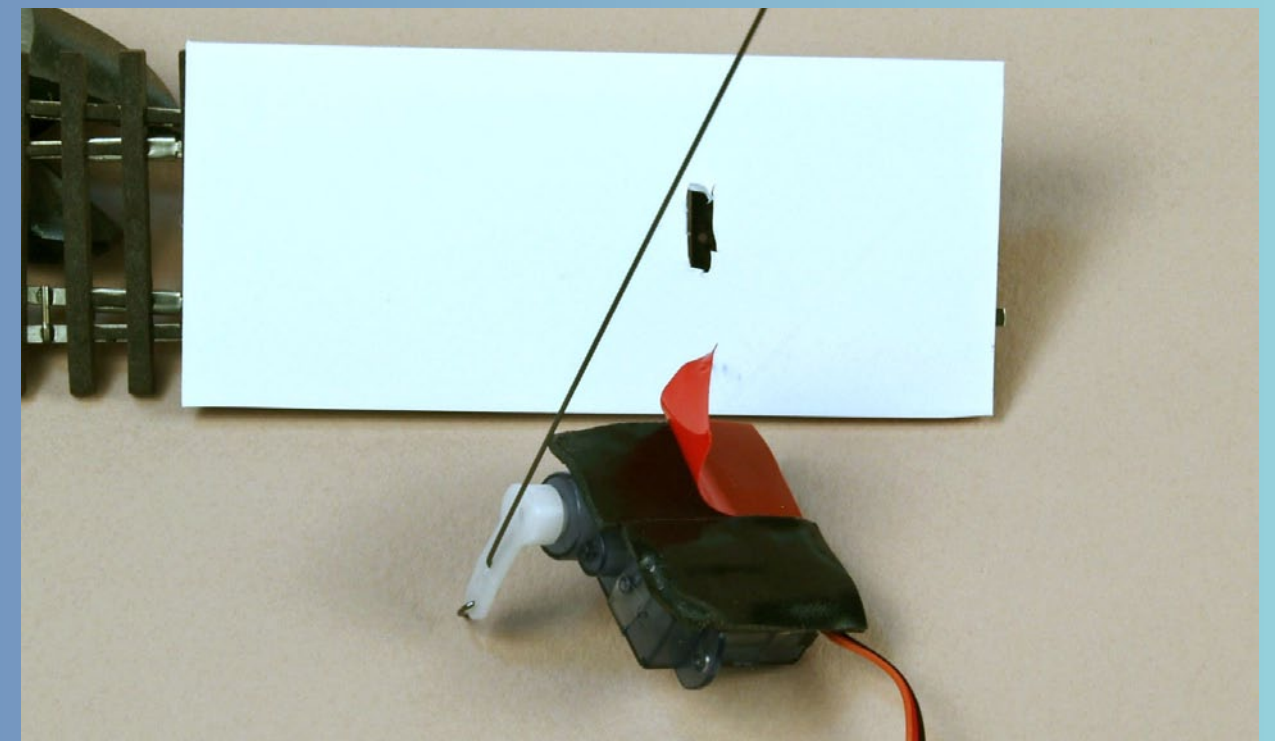
The knife is pointing to a cover over a small spring that needs removing on ME turnouts (Pecos are similar).



The spring has been removed.

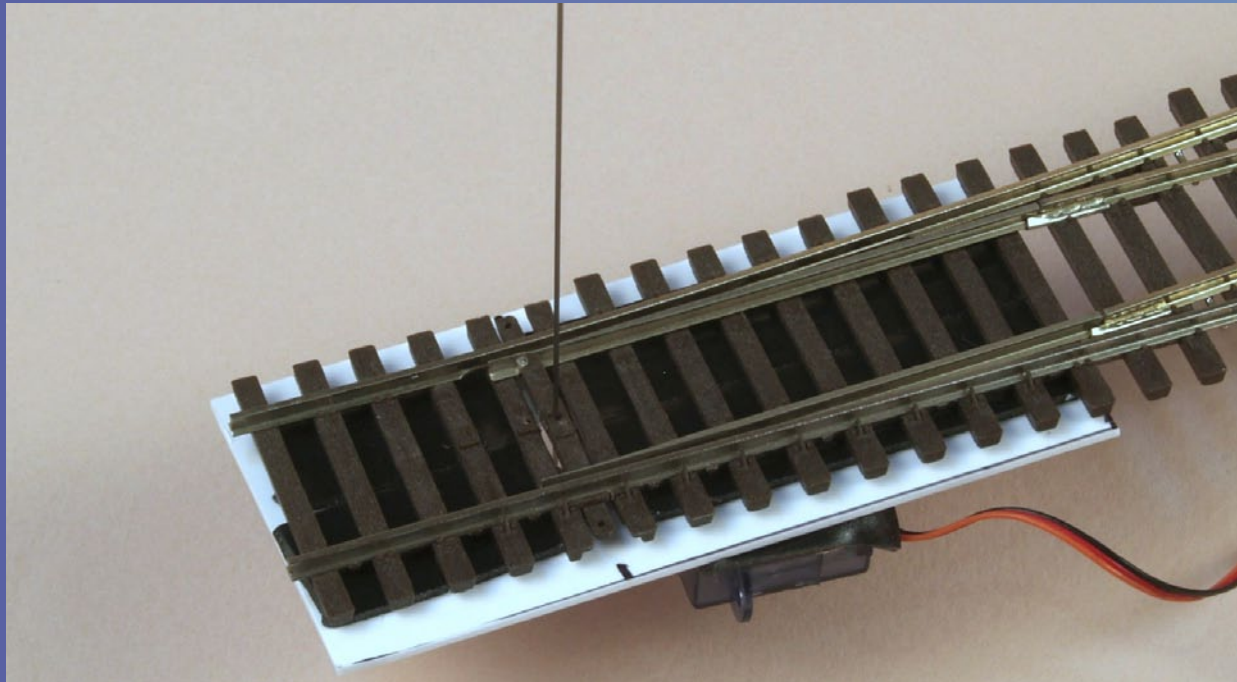


Double-sided tape applied to the styrene base ready for mounting on to the bottom of the turnout. Note how there is a slot in the tape where the throw-bar is going to fit. We don't want the throw-bar stuck to the tape or it won't move!

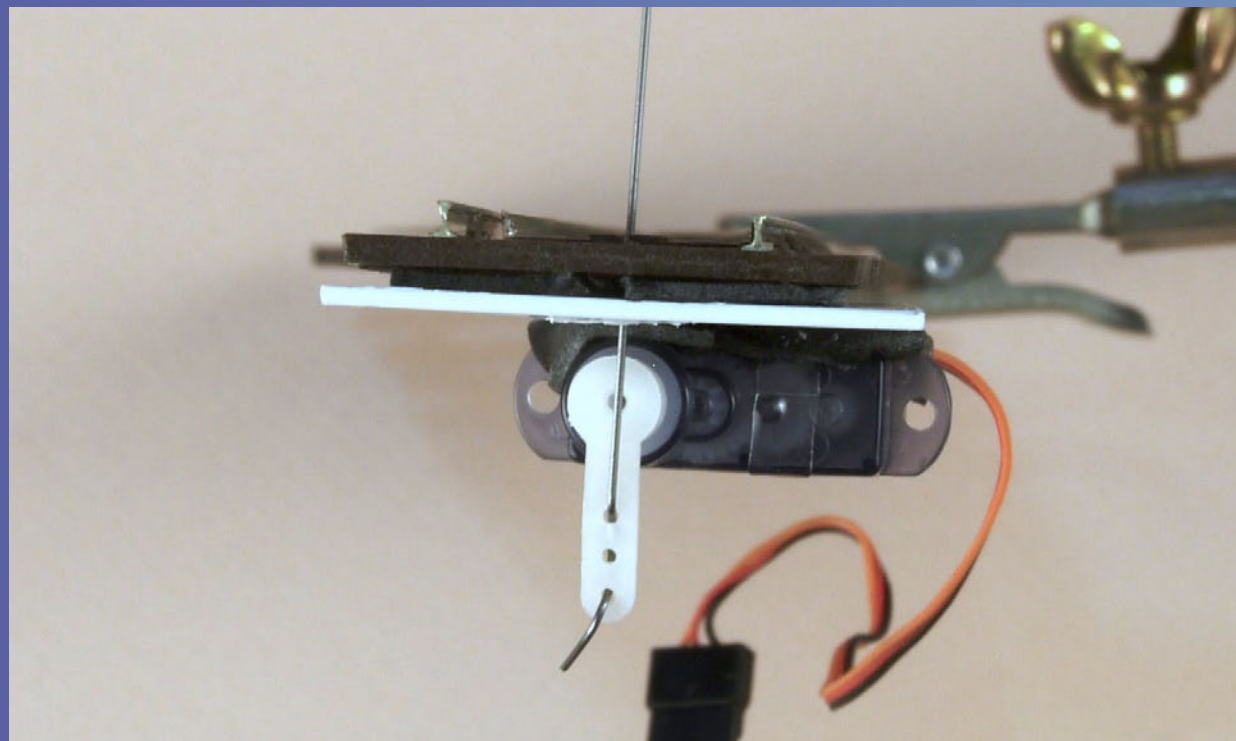


The plate is attached to the bottom of the switch and now more double-sided tape is being applied to the servo prior to attaching it. The servo should be put into its center position and then the servo horn with the wire attached pressed on to the output shaft.

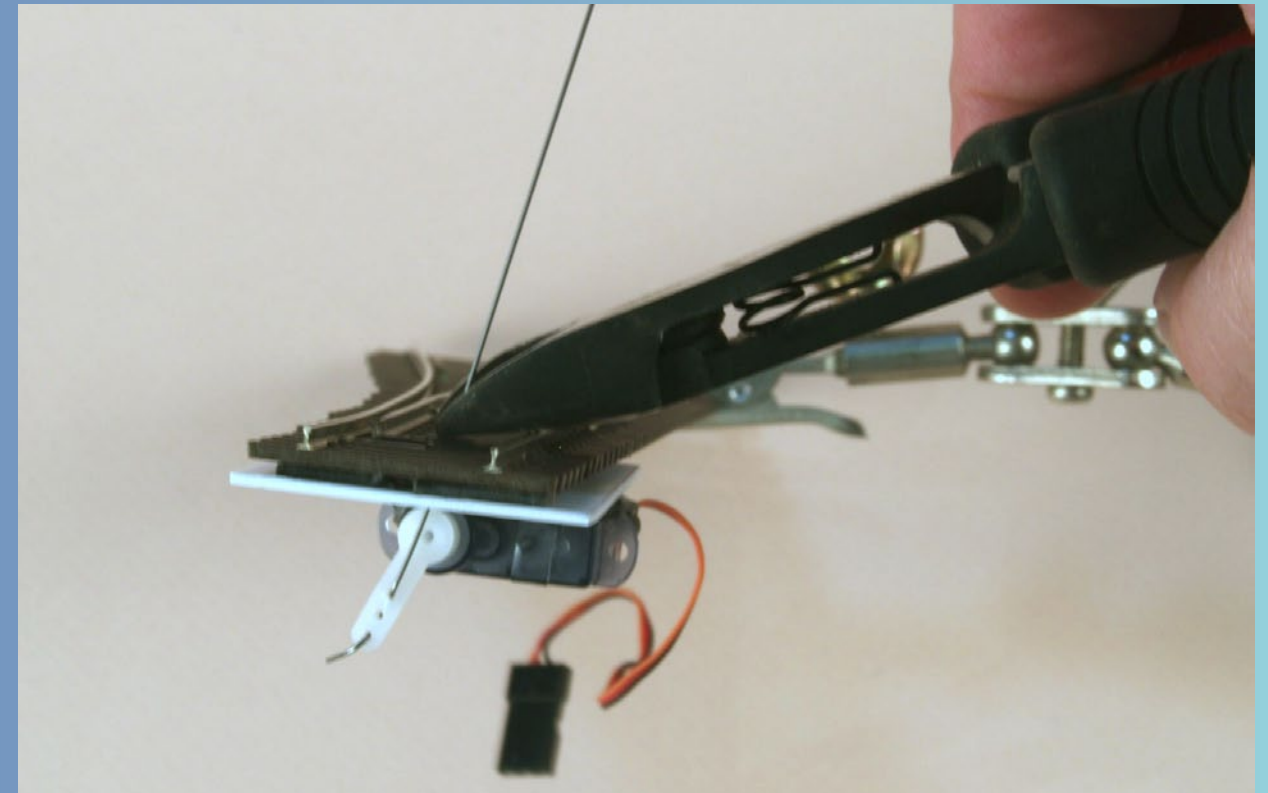
STEP 3: Preparing the Turnout *Continued*



The servo has been placed in position such that the throw bar is in the center. It doesn't have to be exact but neither should it be so far off the points are pressed up hard against one of the rails.

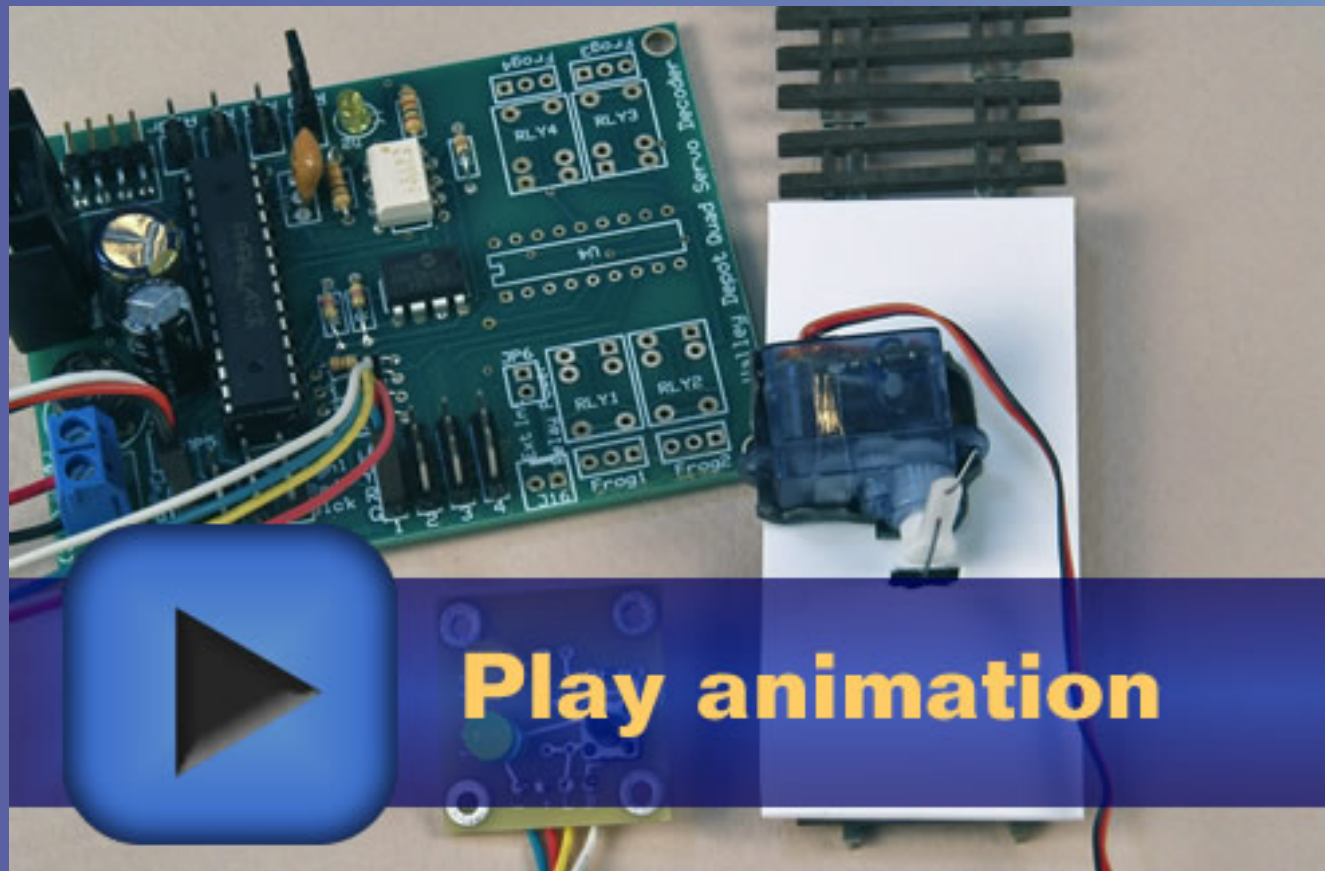


An end-on view of the mounted servo in the center position.



Before cutting off the excess wire, gently move the servo arm to one side as this pulls the wire down in to the hole. If you cut it off too close then when you move the arm to the side, the wire may pull out of the hole.

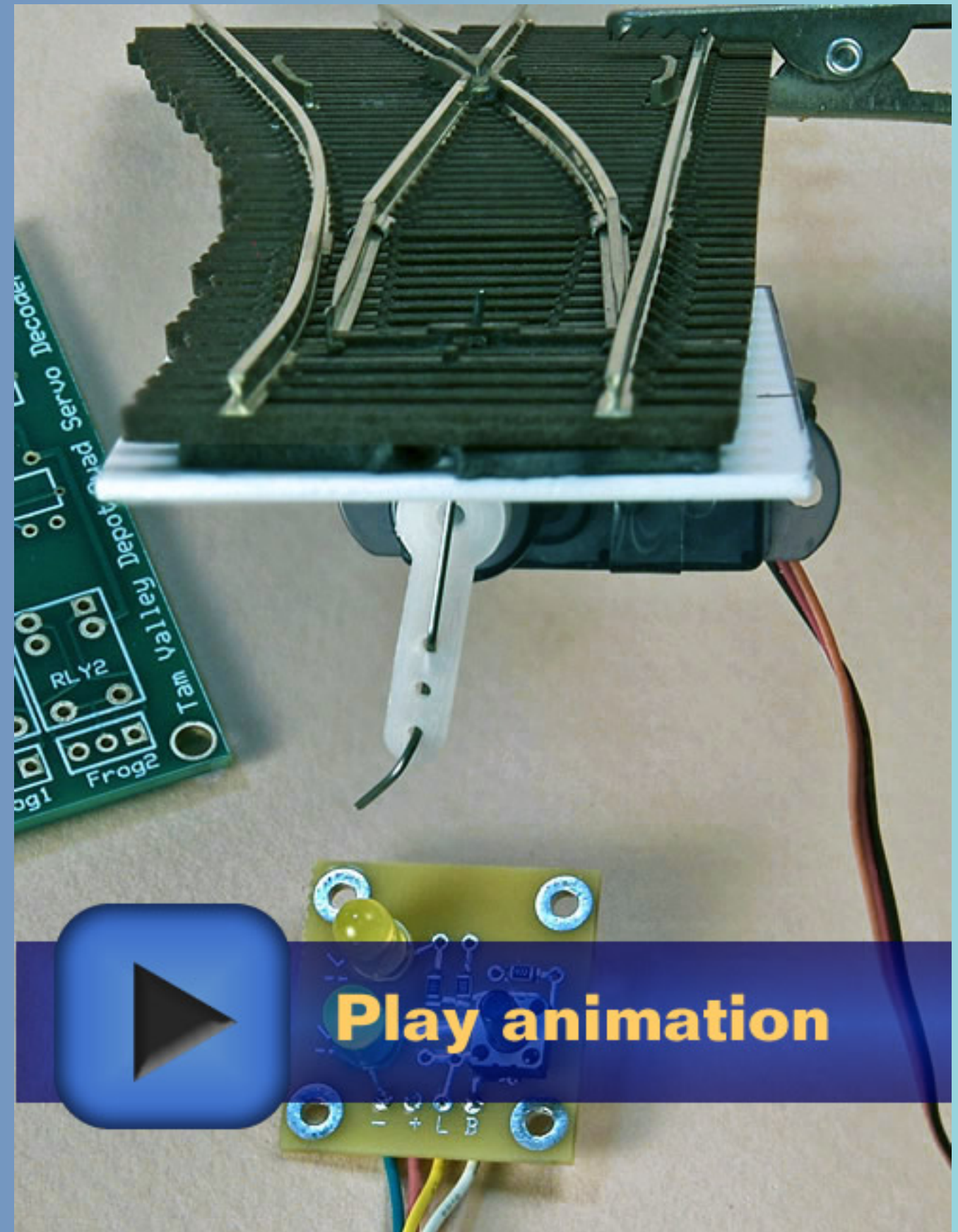
STEP 4: Testing the Servo



Testing the installation, bottom view.

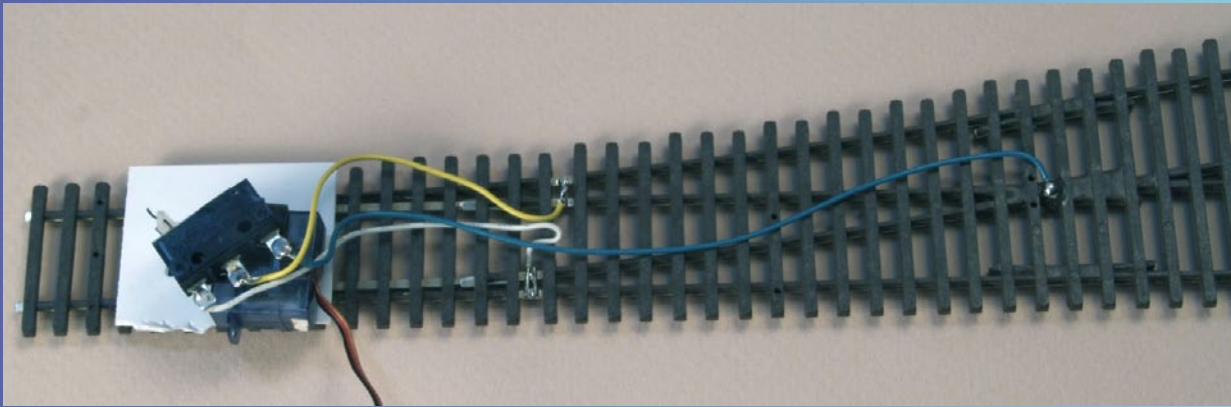


FIGURE 7: Video on the final operation of the servos.

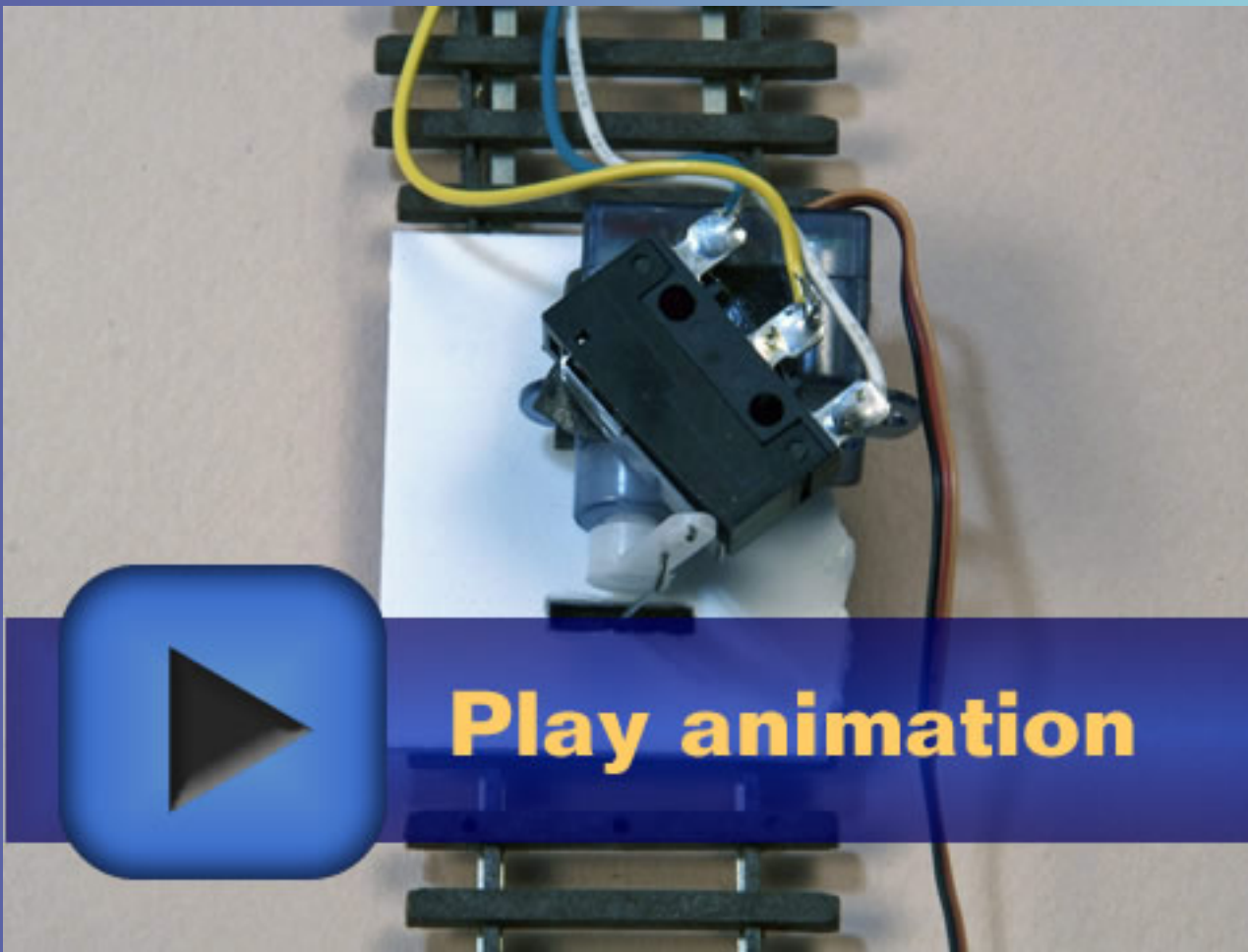


Testing the installation, end view.

STEP 5: Other Applications

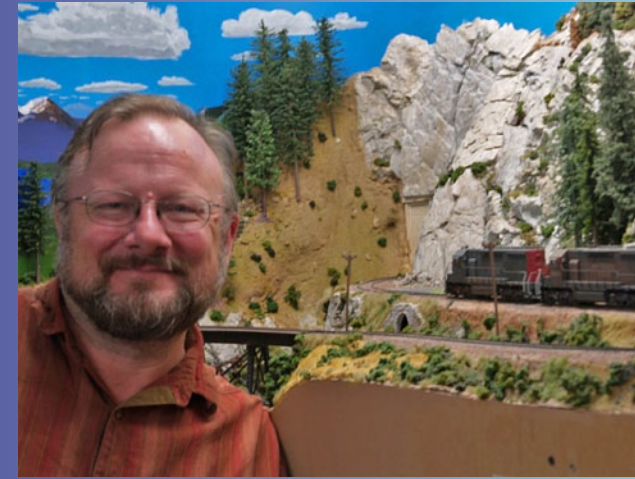


This is a similar installation I did, where I added a SPDT lever switch for frog power switching. The lever switch has been attached with double-sided tape in such a way that when the servo arm moves it closes the switch in one position but not the other. The green wire goes to the frog and the yellow and white are connected to the rails. You have to think hard about how to arrange the switch to get the power routing correct. If you get it wrong you can pry up the switch and replace it with fresh tape.



Play animation

In this animation sequence we can see how the servo arm contacts the lever switch to change the frog power from one route to the other.



Duncan McRee is a native Californian living in San Diego and has been a model railroader most of his life. He is shown here with his latest layout, the Tam Valley, an HO scale proto-freelance of the Southern Pacific.

Duncan also likes to design and build model railroad electronics and recently founded Tam Valley Depot to sell his creations.



Article feedback!

CLICK HERE for reader comments on this article ...



Where to find servos and circuit boards for model railroading use:

- [ANE Models](#)
- [TAM Valley Depot](#)



Some of the finest trees in the hobby ...

...available in any scale!

CANYON CREEK SCENICS

canyoncreekscenics.com

Click to visit our web site

Modeling Telephone Poles

Simple techniques for greater realism

– Bob Grech

Photos by the author

This tutorial describes how I model telephone poles for my layout. If you are considering adding telephone poles to your layout or are unhappy with the commercial ones offered, here's how I go about making mine. This simple detail, done in a realistic fashion, can add life to any layout.

The methods I use take advantage of readily-available materials to simplify construction. Come along as I show you how I construct some my telephone poles from start to finish.

I think you'll agree that these poles look great! I hope enjoy this article and will consider adding telephone poles like these to your layout.

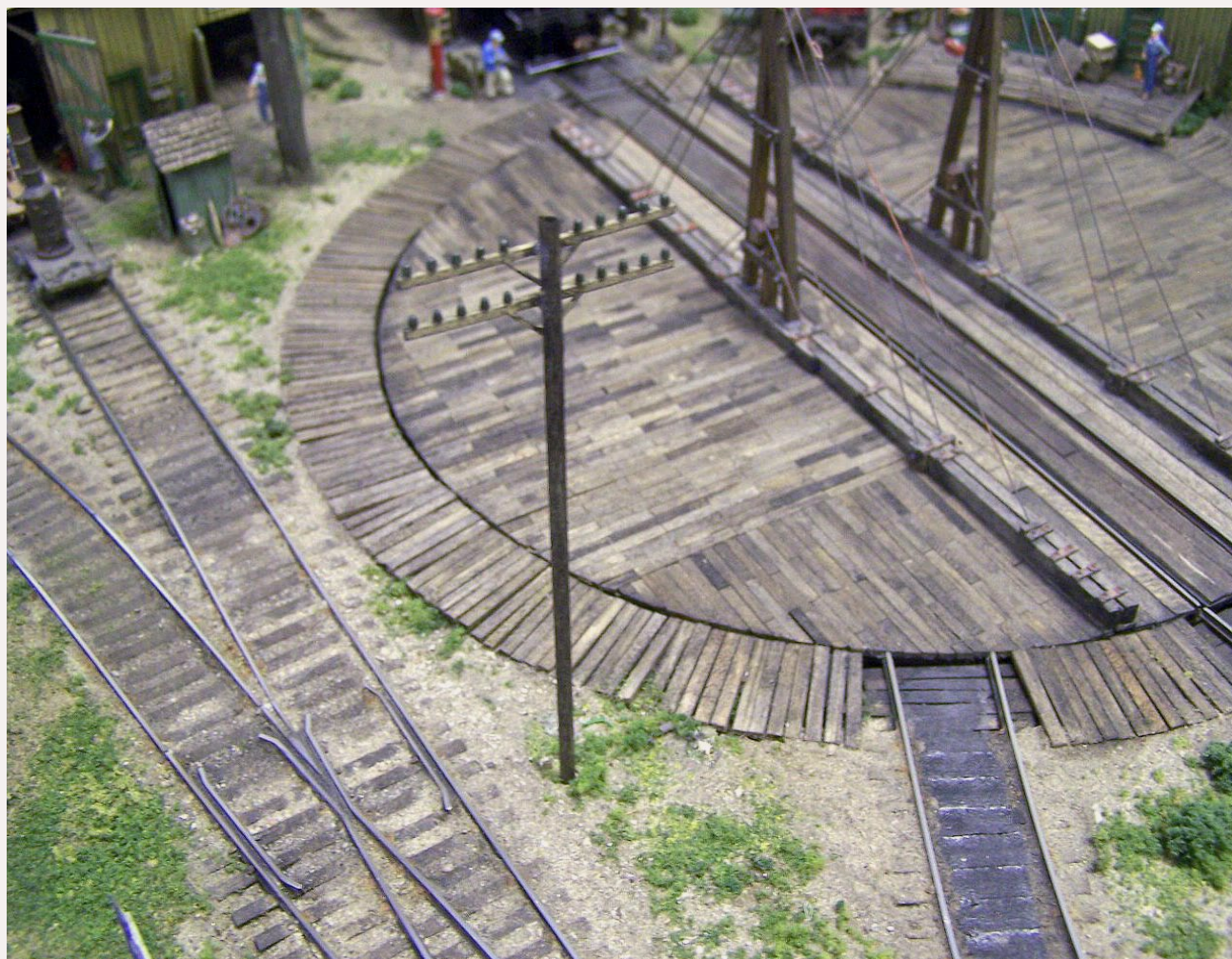


FIGURE 1: A completed pole installed on my layout.

STEP 1: Materials



Figure 2: Materials for the telephone pole project.

Cotton swabs with long wooden sticks such as the ones shown make great looking poles. A bag of 250 of these swabs can be purchased at most drug stores for about 3 dollars. Also shown is a plastic telephone kit (#628-34) by Rix Products: only the cross beams will be used. I don't really use the plastic poles in the Rix kit – I measure the height of my wooden pole replacements from the plastic poles and then discard them.

STEP 2: Preparing the Q-Tips

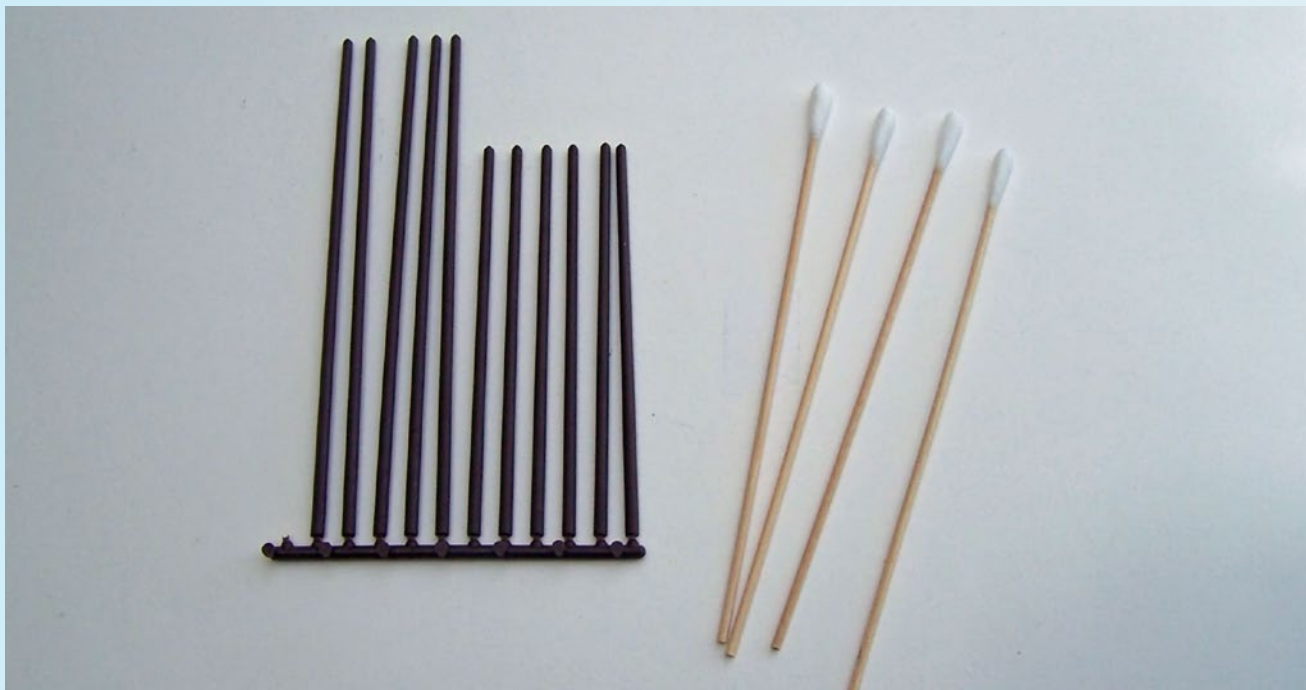


Figure 3: Compare the plastic poles from the Rix kit to the wooden swabs.

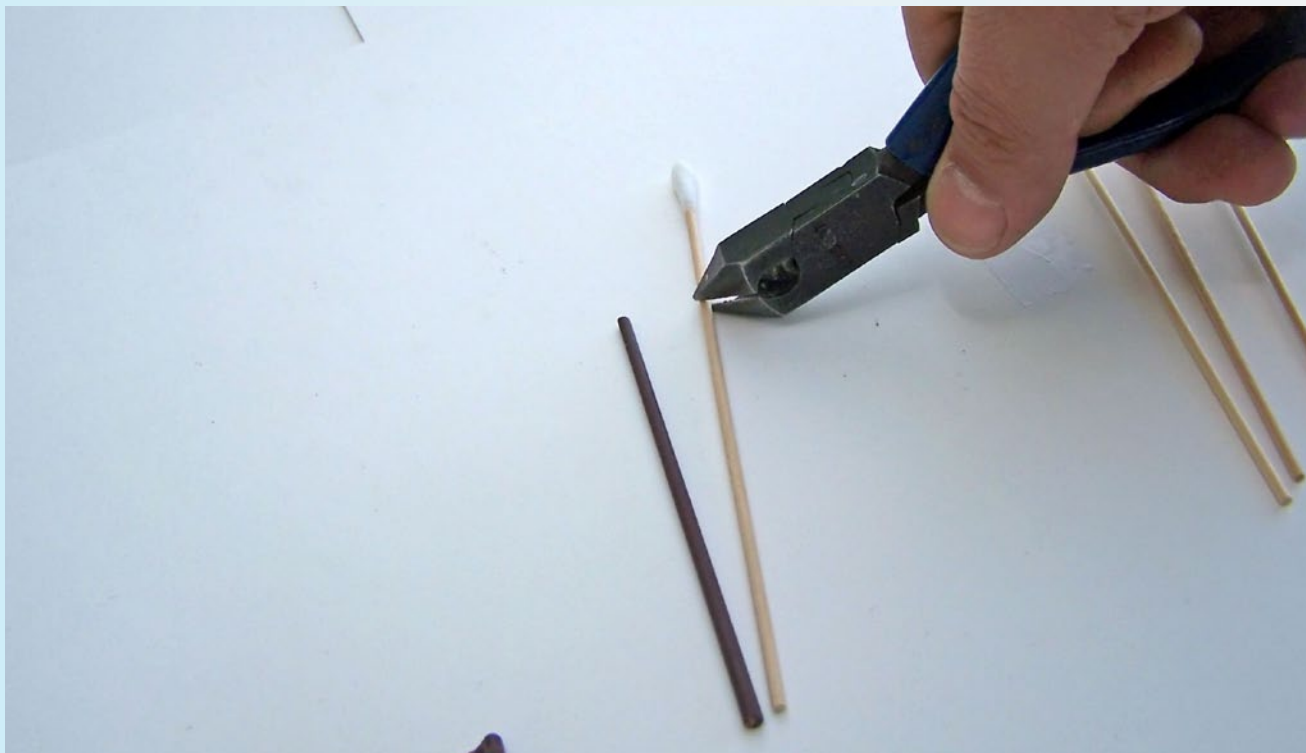


Figure 4: Cut the swab sticks to size.

Using a rail nipper or other cutting tool, cut the wooden sticks to match the height of the pre-measured (30 or 40 foot) plastic poles. I like using the shorter 30 foot poles because they are more typical for the era I model in.

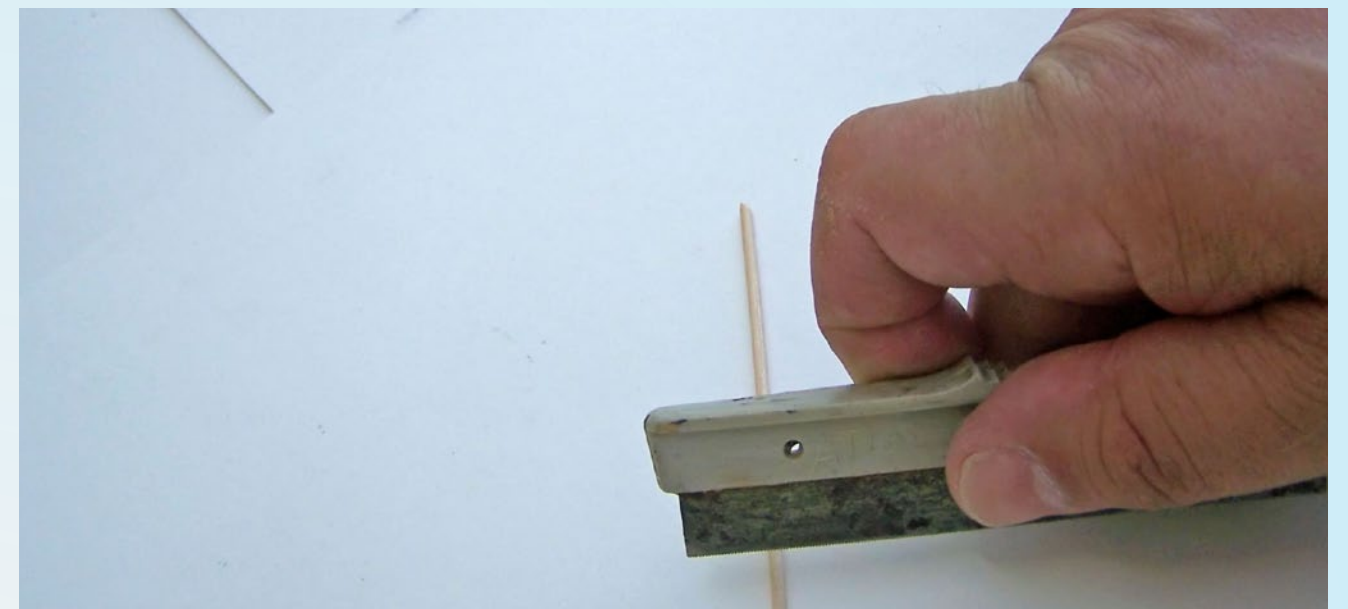


Figure 5: Add the wood grain.

Once I've cut the poles to length, wood grain needs to be added. A fine tooth razor saw does this job nicely. To prevent your wooden poles from warping, I work from the center out, drawing the blade away from me. As I add wood grain, I rotate the poles slowly in order to minimize warping. Then I turn the poles 180 degrees and repeat this process to the unfinished end.

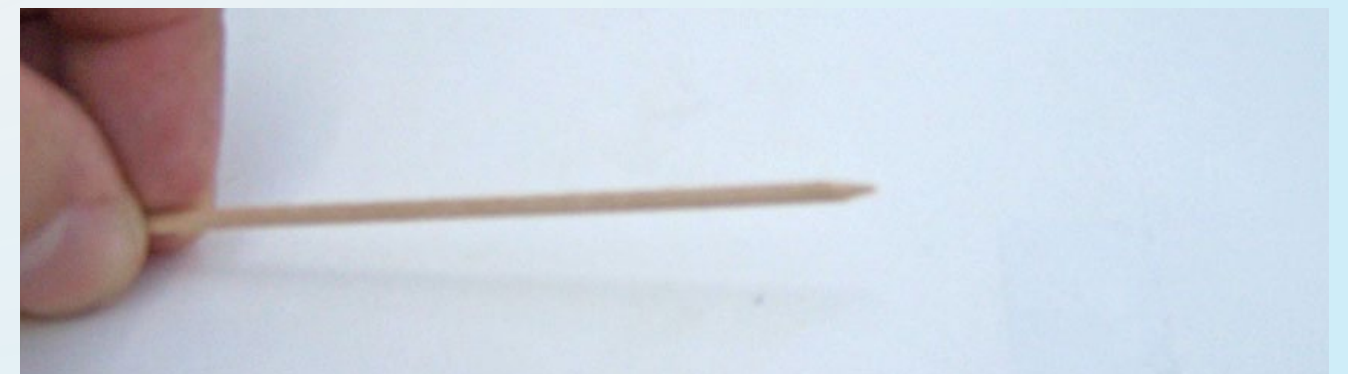


Figure 6: Sharpen the Q-tip.

A quick and easy way to install the poles is to trim the bottom ends as shown, with a sharp blade to form a point. The sharpened point allows the poles to be poked into a foam base easily. If you use Homosote like I do, drill a pilot hole just a tad smaller than the pole to provide a snug fit. This method allows me to install and remove poles easily for photo shoots, maintenance, and so on – all without the need of glue.

STEP 3: Color the Wooden Poles



Figure 7: Dunking the poles in India Ink mixture.

I take the textured and sharpened poles and dunk them in a mixture of alcohol and India ink. The ink formula is 2 full tablespoons of ink to 1 pint of rubbing alcohol. For darker poles, I wait for the first coat of ink to dry, and then dunk the pole a second time.

I do not add more ink than specified to my mix or I'll end up with black colored poles! Trust me, I found this out the hard way! Once the poles are stained, I set them aside and let them dry.

STEP 4: Cross Beams



Figure 8: Color the cross beams.

Next I move on to the cross beams. I spray paint the cross beams using Floquil's "Earth". Earth is a great way to simulate a wood color on any plastic or metal detail. After spraying the beams, I allow them to dry for several hours.

Once the cross beams are dry, I carefully remove them from their sprue. The beams can be cut out of the sprue to represent a single, double, or multiple beam arrangement. This approach allows matching whatever era or location you may be modeling. I like using double beams for my mainline, and single for branch and residential areas.

STEP 5: Applying Q-tip to Cross Beams

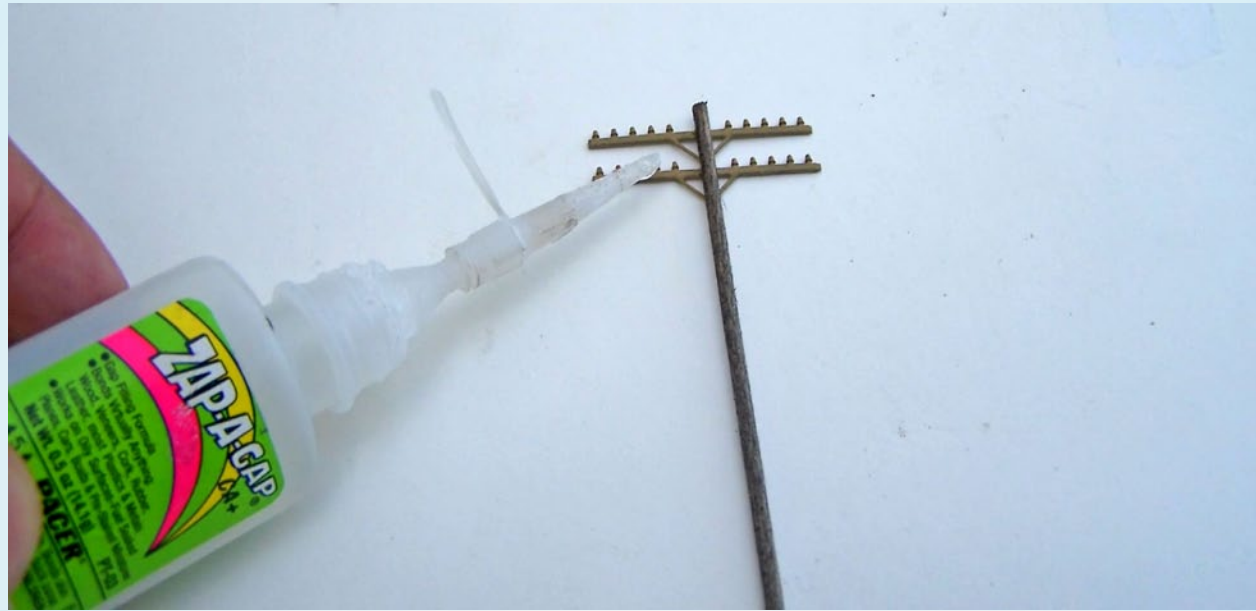


Figure 9: Gluing the cross beams to the colored pole.

I place my selected crossbeam(s) on a flat surface, and apply super glue to insure a good bond between the plastic and wood parts. I use a toothpick or other fine tool to apply the glue. Place the pole directly over the beam, ensure the cross beam is centered and positioned to the correct height of each pole, and apply the glue.

... Article continues on the next page →



Bob's interest in model trains spans over 40 years. His Western Pacific layout was featured in the November 2006 issue of *Model Railroader*, and also in *How To Build Realistic Layouts vol 4*.

Bob lives in Fountain Valley Ca, and is employed as a Mechanical Engineer for the Boeing Company.



Article feedback!

CLICK HERE for reader comments on this article ...



New York Railway Supply



A nice turntable model ...

... plus our turntable motorizing products – means the *best* turntable operation in the hobby!



Click to learn more ...

STEP 6: Finishing up the Telephone Pole

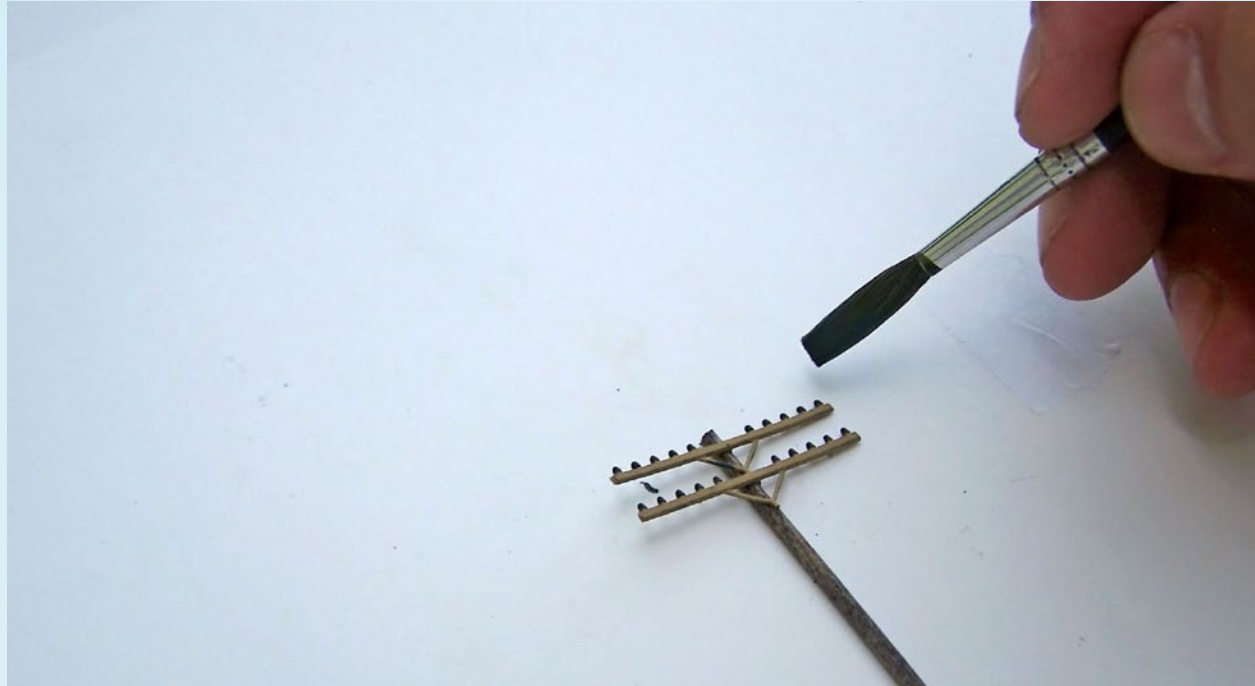



Figure 10: Paint the insulators.

Once the cross beams are firmly in place and the glue has set, I paint the insulators green or gray, and allow the paint to dry.

I dunk the completed poles into the alcohol and ink stain one more time. The stain allows the plastic beams to blend nicely to pre-stained wooden poles.



Figure 11: Touch up the coloring.

Finally, I inspect each pole for any touch up that may be required. With that done, it's time to install my new pole on the layout! 

Also check out our monthly newsletter ...

A screenshot of the Model Railroad Hobbyist newsletter website. The page features a header with the newsletter title and date (December 2008). Below the header, there are several articles and advertisements. One article is titled "The Old Yardmaster" and features a photo of a person working on a model train. Another article is titled "News and views from up and down the line..." and discusses factory representatives from Kadee. There are also advertisements for "Model Trains Video Special" with "Free Shipping!" and "Subscribe to our NEW free mediaZine". The page includes navigation buttons for "N", "HO", and "O" scales, and a search bar.

- Product announcements
- Important hobby event announcements
- MRH Sponsor spotlight
- Next magazine issue sneak peeks

Model Railroad Hobbyist newsletter

The planet's most popular model railroading news mediaZine!

 [Click here](#) to download a recent newsletter.

MRH subscribers get notified by email when the next newsletter is available.

Deluxe Track-Cleaning Slider Car

Homemade car that helps you keep the rails clean

– Mike Ruby

Photos by the author

My layout consists of a lot of hidden storage tracks and some tunnels, and I needed a method of cleaning the track which was relatively easy to do, yet did not require me to scrub the rails with anything too abrasive.

I considered the various commercial track cleaning cars, but decided to try a Masonite™ slider car. These have been in several magazines over the years. Normally a pad is just slung beneath a car, but I believe that additional weight helps the cleaning process. Adding weight to the pad is difficult because of the lack of space under the car, so I decided to add it inside the car.

The car I came up with is built on a 40' Athearn HO "shake the box kit" of many years ago. I have several left over from my early years of modelling. I thought a shorter car would handle the weight better and would have fewer problems with overhangs on curves. I assembled the car normally, although I fitted Kadee couplers, as I do on all my rolling stock.



FIGURE 1: Finished Slider Track Cleaning car.

STEP 1: Making the Cleaning Pad

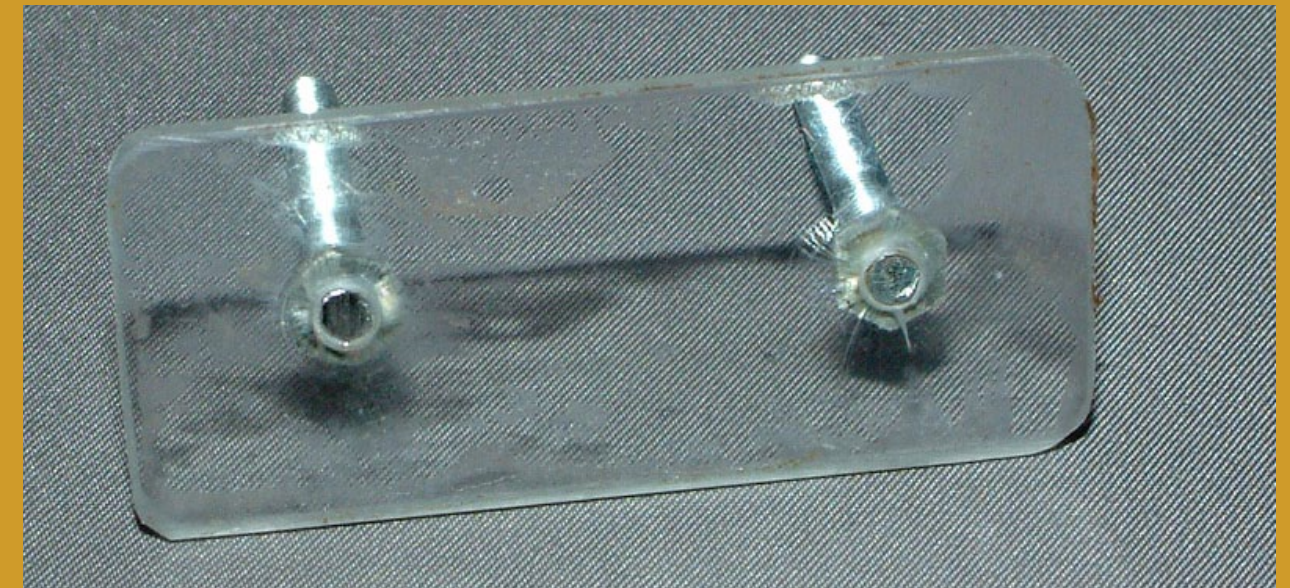


Figure 2: The plastic base for the cleaning pad with threaded rods flush with the sheet.

Rather than mount nails into the pad, as in many designs, I fitted a pair of threaded rods through a plastic sheet. I used 4 mm diameter rod. The rods have to be long enough to extend up into the car far enough to give enough space to mount the weights. I made them 35 mm long.

I used 2 mm acrylic for the plastic sheet, as it is stiffer than styrene. I cut the sheet to 60 mm x 25 mm (2-3/8" x 1"). I drilled two 3.2 mm (1/8") holes along the sheet centre line approximately 35 mm (1-3/8") apart and tapped them for 4 mm. This spacing may be affected by parts of your chassis, so check it before drilling. Also make sure your holes are perpendicular to the sheet, so that the rods are the same distance apart at the top as at the bottom. As shown in the photo, being spot on the centre is not critical. Most important is that all the holes through all the components line up.

STEP 1: Making the Cleaning Pad (continued)

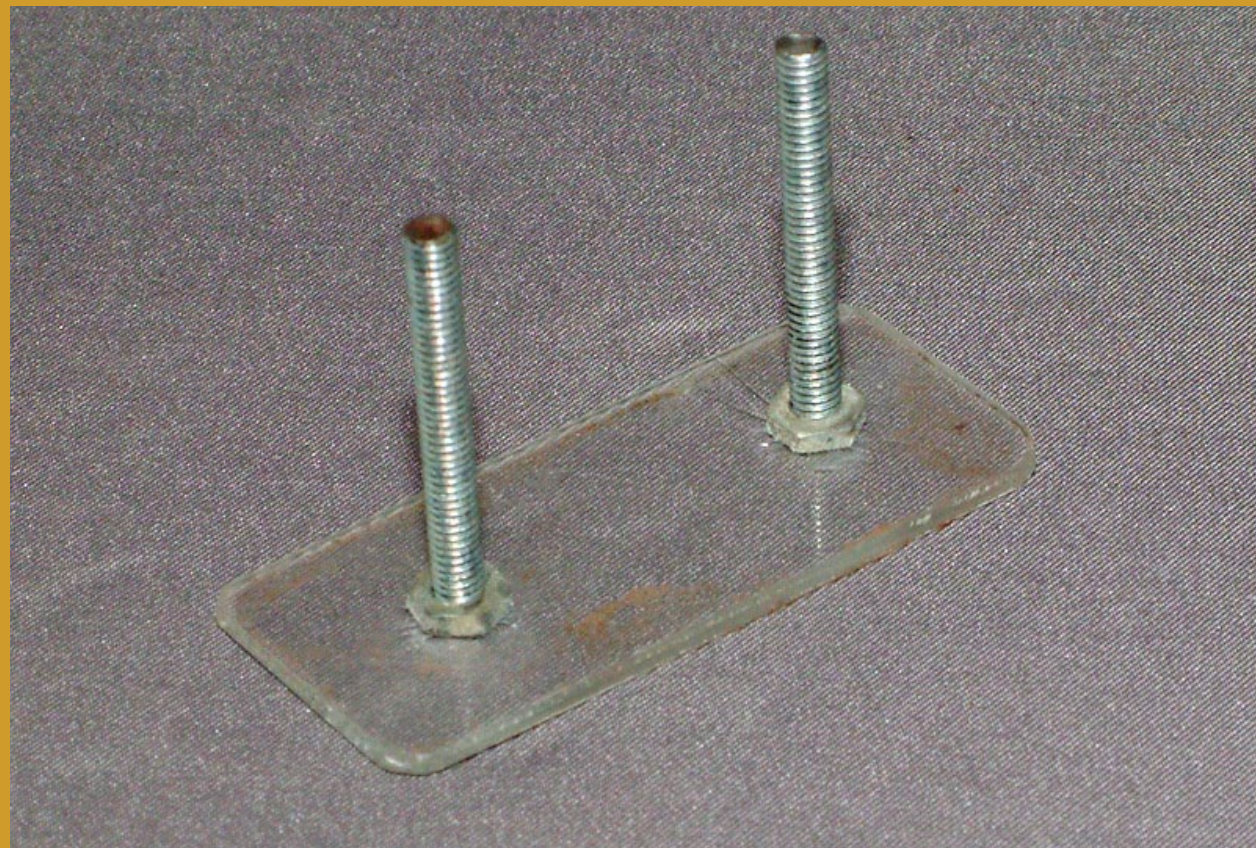


Figure 3: Nuts securing the rods in the plastic.

To secure the sheet, fit the rods so they are flush with the face of the plastic, then run a nut down each rod on to the plastic sheet. Note I had some half nuts (as it sounds, they are about half the height of standard nuts). These give a bit more clearance between the pad and chassis. If you do not have these either file down a pair of standard nuts or cut away some of the chassis.

I then drilled two holes, to match the threaded rod spacing, through the centre line of the car floor. These holes must allow the pad to move up and down freely, I made them 1 mm (approx. 1/32") larger than the rods.

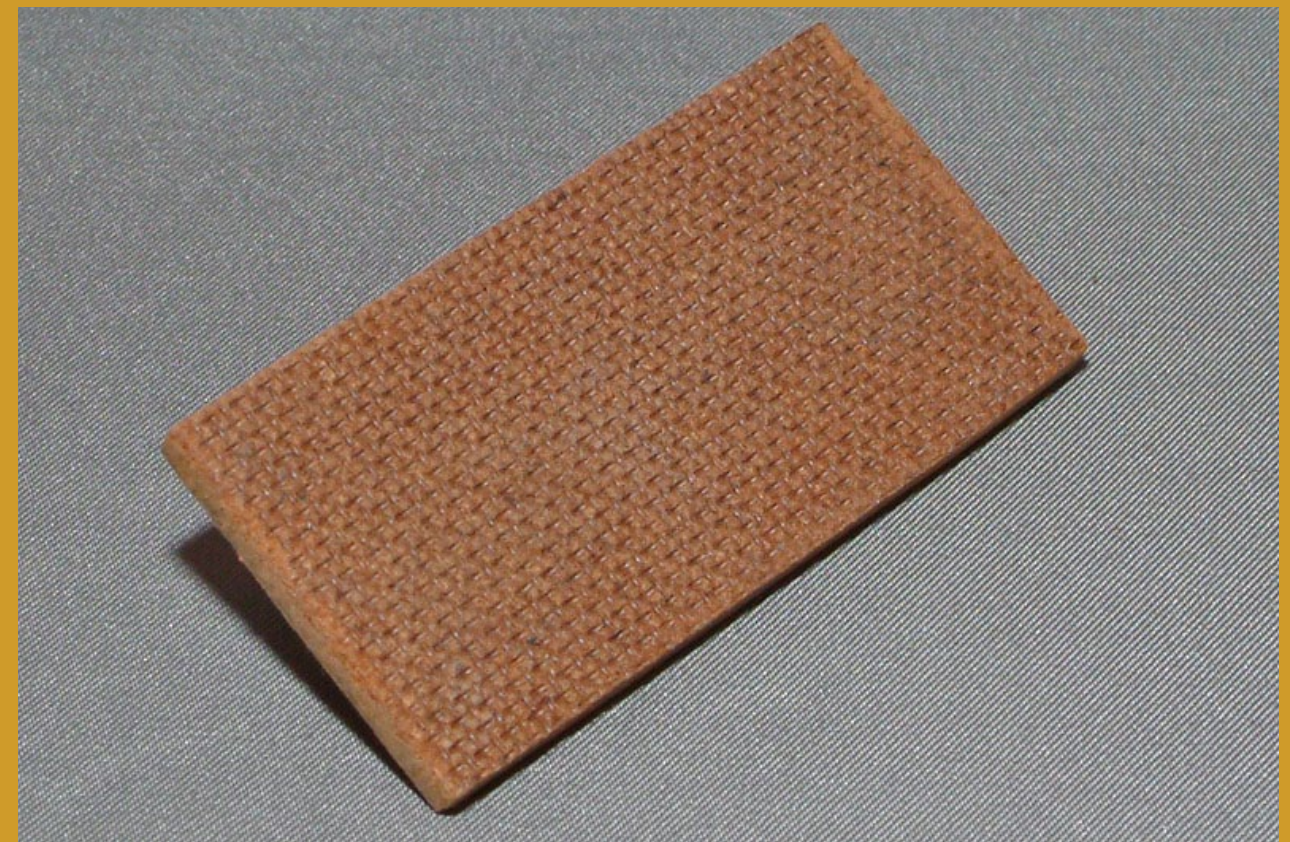


Figure 4: The masonite pad cut to size. This will be the cleaning surface.

For the cleaning pad I cut a piece of 4 mm (1/8") thick Masonite™ the same size as the plastic sheet. My layout has a minimum radius of 30" and this width on a 40' car easily stays on the rails. If you use sharper curves a wider pad may be required.

STEP 1: Making the Cleaning Pad (continued)



Figure 5: The cleaning pad with the edges beveled.

The front and rear edges were sanded to approximately a 45 degree angle to allow the pad to run over any track irregularities. Note I used a Mini Craft circular sander to make the pad to size and bevel the edges, but coarse sandpaper wrapped around a wood block will work as well.



Figure 6: Double-sided tape on the smooth side of the cleaning pad.

I stuck the Masonite pad to the plastic with double-sided tape. I used tape for smooth surfaces. The type for rough surfaces is a lot stickier and you may not be able to remove the pad. This allows the pad to be replaced. A little levering will remove the pad. I use it rough side down, partly because the smooth side will stick to the tape better, but also because I believe the rough side cleans better.

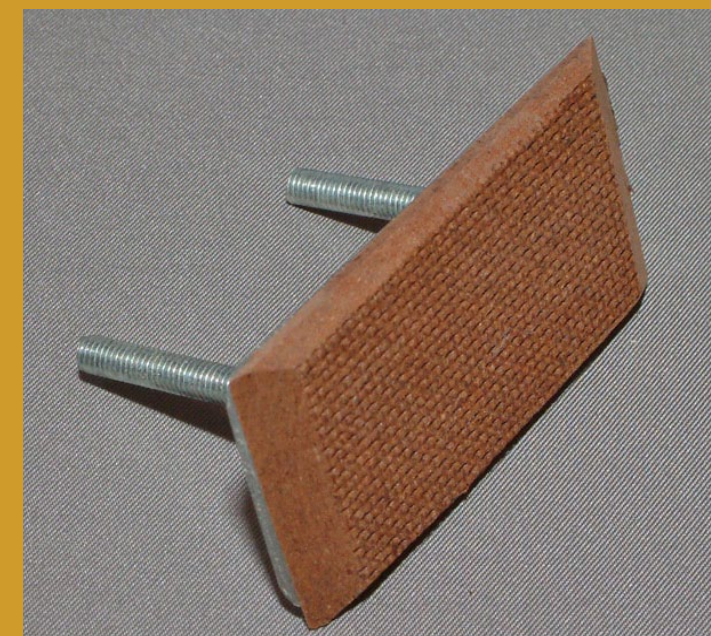


Figure 7: The finished pad. With the Masonite™ stuck to the pad.

STEP 2: Adding the Weights

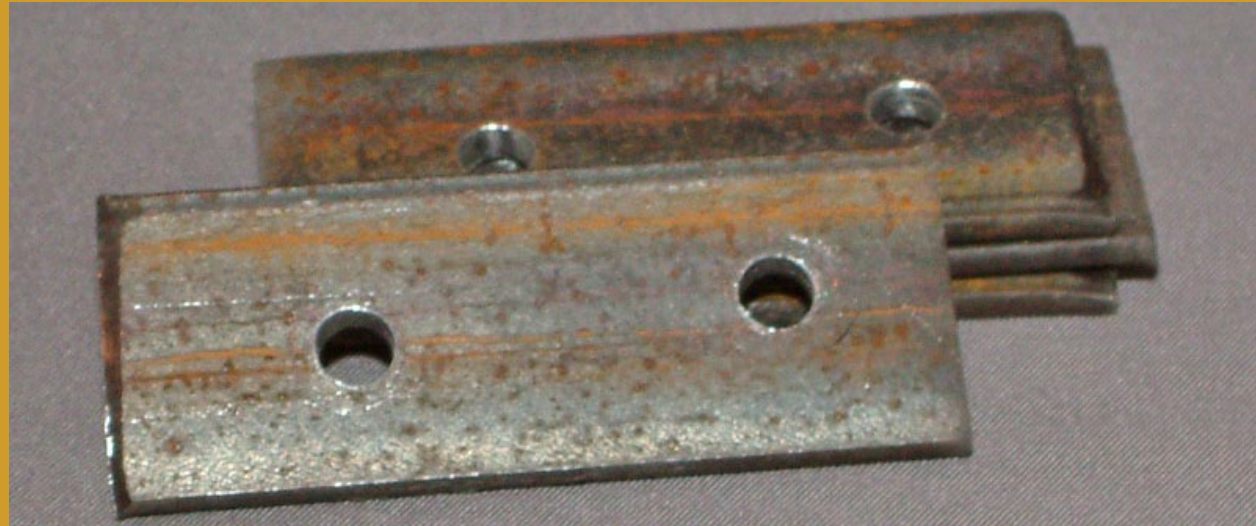


Figure 8: The steel weights for the cleaning pad. You can see my holes were not very accurate!

To add weight to the pad I used 25mm (1") wide by 3 mm (approx. 1/8") thick steel strip cut to 70 mm (2-3/4") long. I used a guillotine at work, but a hacksaw works but with more effort! This strip can be obtained from do-it-yourself stores here in the UK. I also use this material for adding weight to my other cars, so a 3' or 4' length is not wasted. I found I could fit 4 strips to my car.

Once cut, use masking tape to clamp the strips together. Mark the bolt spacing along the centre line of the strips and drill clearance holes through the strips. A bench drill makes this easy, so I used a battery drill, and tried to be careful to drill perpendicular to the strips, which also explains why my holes are not quite in line!

Locating steel bar stock and acrylic sheet

Finding this steel bar stock in small quantities for a reasonable price in the US can be a challenge. You want cold rolled C1018 steel bar stock, 1/8" thick x 1" wide. Amazon.com (surprise!) sells C1018 stock online – with shipping it's about \$8 for a 6 foot strip: [just click this link for more](#).

You can also find this item at Speedy Metals: [click here for more](#). Cost is about 10 cents per inch, plus a minimum of \$12 shipping. It pays to go in together with friends and get 10 or 20 feet of the bar stock from Speedy Metals, to make shipping cost effective.

STEP 3: Connecting the Weights to the Car Floor



Figure 9: The car chassis, fitted with steel weights over the trucks.

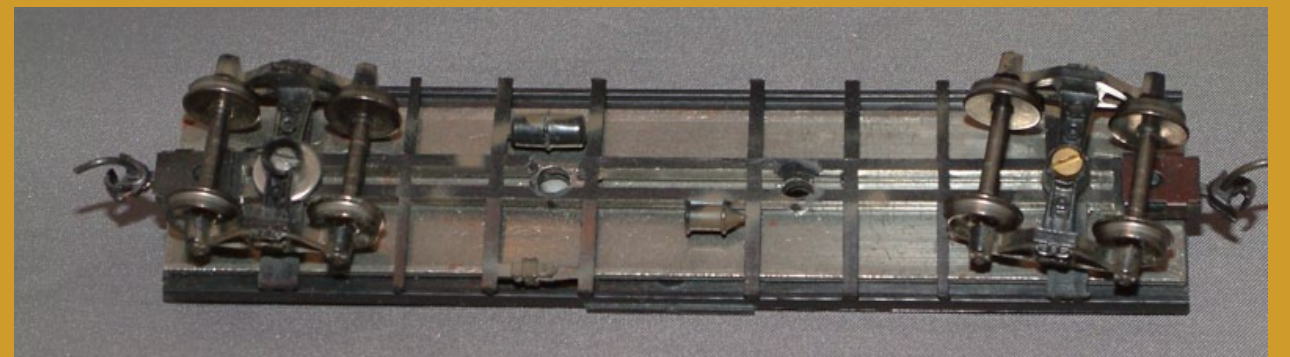


Figure 10: The car chassis underside with holes drilled for the pad.

To mount the weights, fit the bolts through the car floor and run a nut down each bolt. Make sure you leave enough space between these nuts and the car floor to allow the pad to contact the rail with about 2 mm (1/16") to spare. Then secure the weights to the bolts with another pair of nuts. Make sure the pad can move up and down freely.

As for the 2mm acrylic plastic Mike mentions, you can use our handy-dandy **Modeling Sizes Chart** ([available here](#)) to determine that 2mm is equivalent to .080" thick sheet.

However, 1/8" sheet is easier to find, and is only 45 thousandths thicker – not enough to hurt. Again, Amazon.com sells 1/8" acrylic sheet in 12" squares for about \$13 with shipping: [click here to learn more](#). Or you can Google ".080 acrylic sheet" and find many sources.

To cut acrylic sheet this thick, you'll need a table saw and a special blade since the stuff is quite tough. Or you can use easier-to-cut styrene, although it won't be quite as durable as acrylic sheet. – J.F. ■

STEP 4: Trying the Car

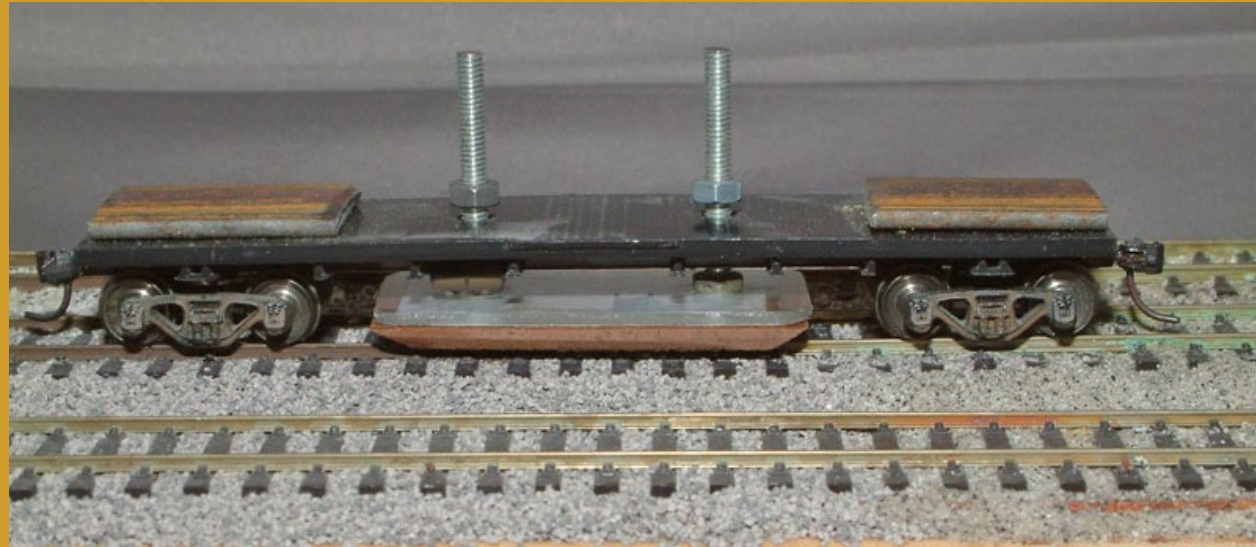


Figure 11: Setting the lower weight nuts. With the pad on the track leave space under the nuts.

I now tried the car in this state, but found it tended to derail when going around curves. The pad was so heavy it forced the car to go where it wanted. To correct this I added a 35 mm (1-3/8") length of the 25mm steel strip above each truck to provide extra weight. This cured the problem and the car now tracked through curves and turn-outs with no problems.

I usually run the car in front of a pair of locos. It weighs about 300g (10.5oz) half of that is on the cleaning pad. I have 4% grades and find this amount of power is required, if running the track cleaner wet.



Figure 12: The weights mounted on the pad threaded rods and secured with two more nuts.

STEP 5: Using the Car

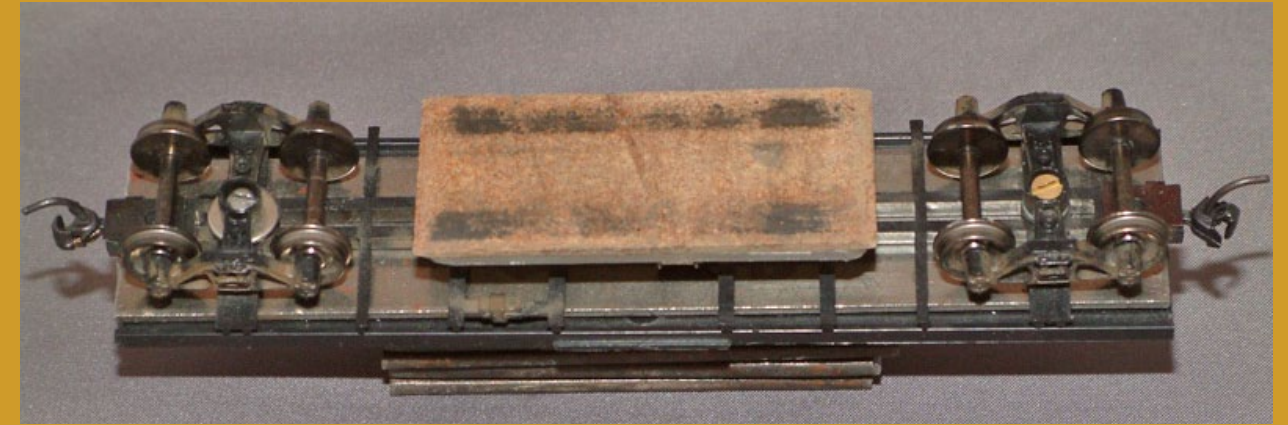


Figure 9: The car after doing its job. This is best cleaned off with sandpaper wrapped around a wood block.

To really clean the track I put lines of Rail Zip track cleaner on the pad where the rails touch it. The Masonite soaks up the Rail Zip and will deposit it on the track for at least 100'. I have found that the deposit can make the track slippery, so I now run a Centerline cleaning car behind the locos to pick up most of the excess liquid. I tried Goo Gone but found it evaporates too quickly from the pad, and also seems to be less effective at cleaning the track.

If too much crud builds up on the pad, I clean it using coarse sandpaper, wrapped around a block of wood. This will eventually wear out the pad. When this happens make a new Masonite pad to replace it. How quickly the pad gets dirty depends on how dirty your track is.

If my layout has not been used for a while, and I have been constructing in the room, it can need cleaning after one trip around, about 90 feet. At least if it gets dirty it must be working! I usually run the cleaning train around before an operating session. I also have a magnet car in the train to pick up any unwanted bits of steel lying around.

I find the car works well. When locos begin hesitating and the sound becomes erratic, running the car cures the problem.

It will not remove really stubborn dirt like paint or glue, but cleans the normal build-up from running trains.

Some times I have to make several passes over a piece of track. The car really



Mike Ruby lives in Plymouth, England, and has been modelling from a very early age. He has modelled US prototypes since the late 70s, and is now modelling the modern era Union Pacific and late logging.

His current layout is an HO freelance of the Siskiyou line area as if UP was still running the line.

The layout is built in an 11' x 10' room, and runs, but still has a lot of scenery work to do.



Article feedback!

CLICK HERE for reader comments on this article ...



proves its worth in the tunnels and hidden storage tracks which cover about 25% of my route.

One problem I have found is that the slider will pick up so much dirt that it "grips" the track, and even a pair of locos will slip on level track. That indicates you should have cleaned the pad sooner!

The track-cleaning car runs very reliably through turnouts, track joints, etc. I have used it at the front of a train to spread cleaner on the train wheels, just make sure the engine has enough power to haul itself and the train!

After further experiments, I found that pushing the slider car with the Centerline car in front, with plenty of Rail Zip on the Centerline car roller works even better.

The Centerline car doesn't seem to get very dirty but the Masonite™ slider does. It also leaves a very thin layer of

cleaner on the track, which seems to help running for a longer period.

After traversing all my mainline, about 75' (sidings 40' and hidden storage loops 80'), it was still depositing Rail Zip at the same rate.

Based on loco behavior it cleans better than my previous method. Even the lights in my caboose, with homemade pickups, work well now.

The only disadvantage to the extra cleaning fluid left on the track is I lose some traction, but it makes for more interesting running up the 4% grade, where a train on the loading limit needs to be handled carefully.

Parts List

- 70 mm long 4 mm dia threaded rod.
- 6 x 4 mm nuts (2 x half nuts or file them down).
- 2 mm thick acrylic sheet.*
- 4 mm Masonite (hardboard).
- 350mm x 25mm x 3mm steel strip.*
- Double-sided tape.

* Also see locating materials sidebar.

When you see this symbol, it means:



"Click here to learn more!"

Every click tells advertisers an ad in MRH is a wise investment ...



Upgrading the Kato 2 Bay Covered Hopper

from the
bench



— by **Mont Switzer**
photos by the author

We are fortunate to have the KATO 2 bay covered hopper kit. It is a dead ringer for the Monon's C.I.L. 4331 - 4390 series covered hoppers built by Pullman Standard in 1953. Even more fortuitous is the fact that the kits come with factory applied Monon paint and lettering which has proven to be very accurate (see Figures 1 and 2).

Other railroad paint schemes offered include Chesapeake & Ohio, Erie, Milwaukee, Nickel Plate Road, Seaboard Air Line, and WABASH with similarly accurate paint and lettering. They are sold in packs of three kits for each of these railroads.



Figure 1: MON 4349 represents the as delivered paint scheme for these cars with heavy weathering and lettering modifications. The first modification is the repainting of the as delivered "C.I.L." reporting marks to MON. This lettering change was adopted in early 1956 and dates any cars where the change has been made. Numerous assignment changes and reweighing have caused the patchwork repainting on the car sides. Shown in cement service this car was photographed by Mont Switzer in Indianapolis, IN in August of 1966.



Figure 2: MON 4366 illustrates the paint scheme that was applied to Monon two bay covered hoppers in the late 1960's and well into the "MON" reporting marks era. Again assignment data changes add patchwork repainting to the sides. Notice dust covers the entire car. Photographed by Mont Switzer in Indianapolis, IN in August 1966.

The KATO kits are so well engineered that assembly is all press fit – no glue required. Just follow the sequence described in the instructions and the kit will press fit together.

However there have been advancements in the hobby since the introduction of these kits and they now need a little help to bring their details up to the current standards seen in the hobby today. These detail improvements are the subject of this article.

Kato furnishes an excellent set of instructions which should be

followed. This article will "jump in" during the various assembly steps to describe how to enhance the details of the various kit components. So let's get started.

Trucks

The correct (for Monon) ASF A-3 ride control trucks are furnished with the kits. I like to replace the wheel sets with REBOXX .088 wide semi scale wheel sets. In my opinion they look and operate better. Everything but the wheel treads of the REBOXX wheel sets should be painted with Floquil grimy black.

Before assembling the trucks media blast the truck side frames. This process was originally intended to achieve a surface that would hold paint. However, the resulting weathered gray flat finish eliminates the need for paint. The truck details can be further enhanced with Bragdon weathering powders: rust around the springs and black around the journals. No painting required!

Couplers

I prefer the state of the art Kadee short shank scale couplers with whisker springs. They fit into the coupler boxes on the model and the whisker springs

make installation quick and easy. Before installation give the couplers (not the shanks) a light coating of Floquil rust and rail tie brown mixed half and half and applied with an air brush.

Under Frame

The under frame goes together as in the instructions with only two changes. First, shave off the brake rigging cast into the bottom of the frame and replace it with .012 wire in #78 holes. This rigging hangs down on the prototype and is visible if the prototype or model is viewed in profile (Figure 3).

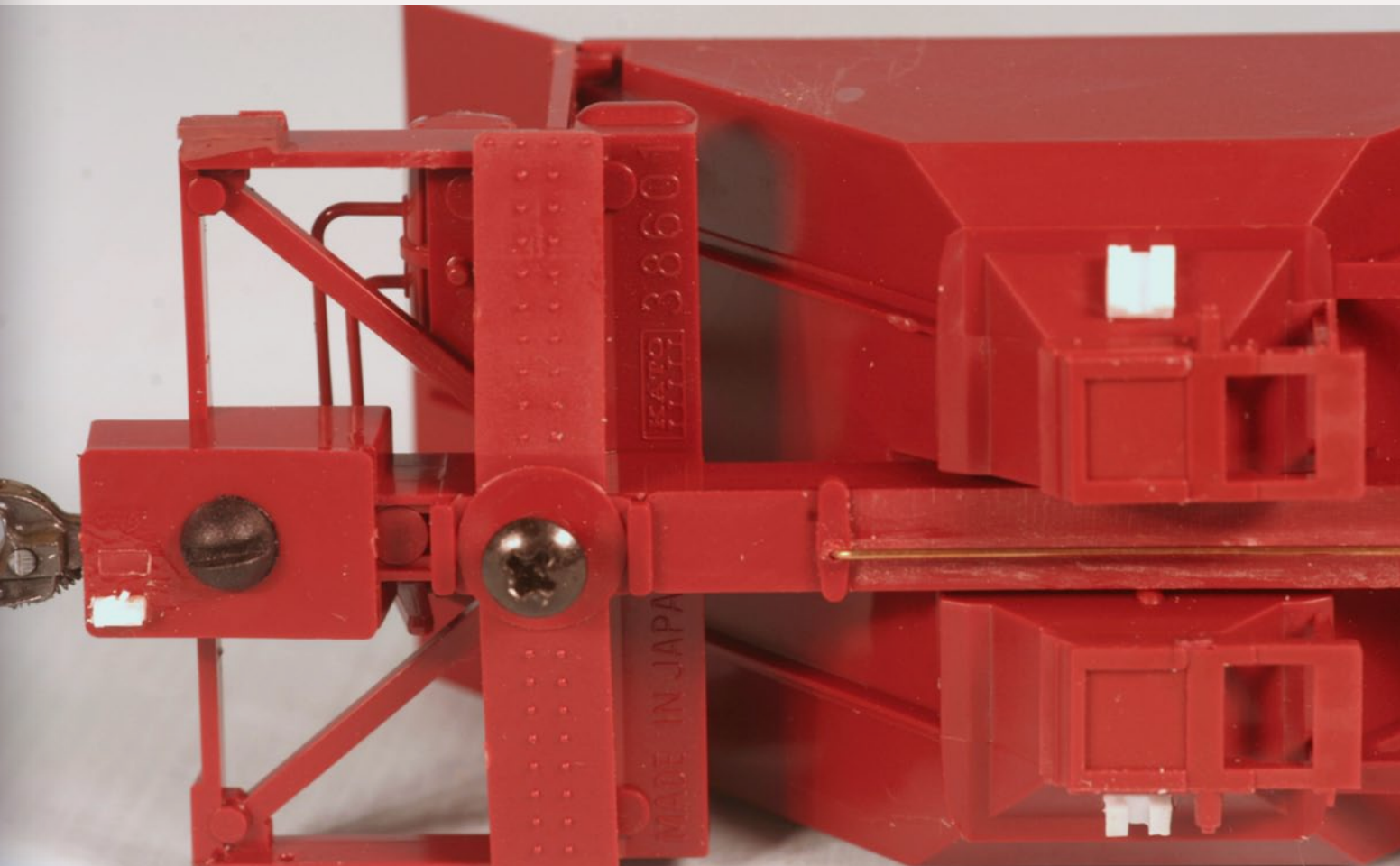


Figure 3: The appearance of the car when viewed in profile can be improved by scraping off the cast on brake rod with a chisel blade model knife. Replace it with a piece of .0125 phosphor bronze wire bent to fit into holes drilled in the centers of the cast on brake levers as shown.

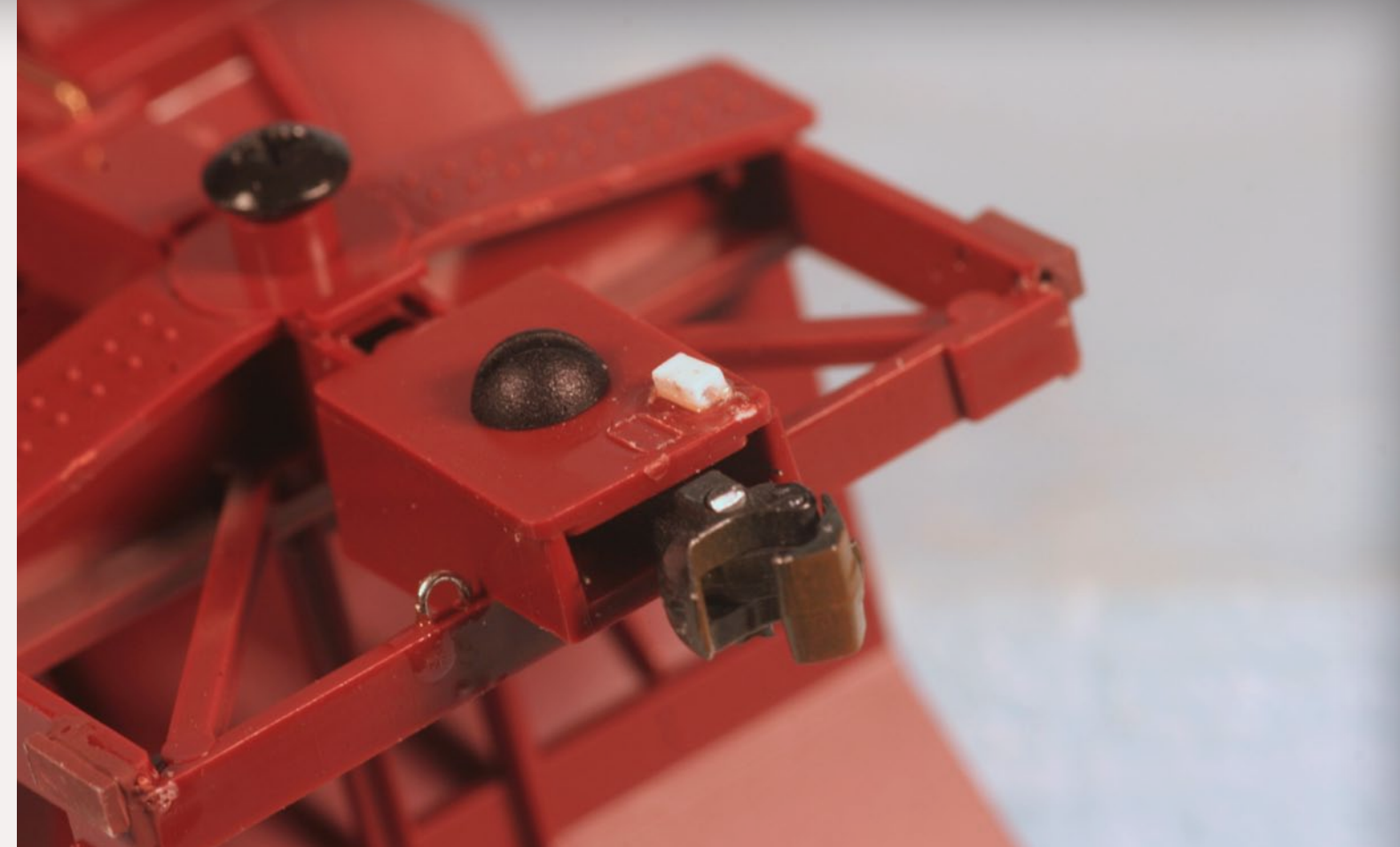


Figure 4: The press fit coupler pocket covers were modified to accept an engineering plastic screw during installation of the short shank Kadee couplers allowing easy access for servicing. The small piece of scrap styrene cemented to the coupler pocket cover is drilled to secure the coupler end of the coupler cut lever yet to be applied. The wire loop to the left of the pocket is a bracket for the yet to be installed air hose.

The second change is the press fit coupler pockets. Cut the mounting pin off of the inside of the coupler pocket cover and drill this area out with a number 43 drill. Then drill the coupler pocket center pin out with a 50 drill and tap the hole it for a 2-56 screw.

Insert a Kadee fiber 2-56 screw through the cover and run it all the way into the newly tapped hole. When the screw is all the way in shave it off even with the top of the coupler pocket. Save coupler mounting for after painting. The screw mounting of couplers is stronger and allows access

to the pockets for coupler changes or maintenance (Figure 4).

Underbody

Follow the kit instructions noting the A and B ends. Because my models were to be heavily weathered for cement service I left the under bodies separate from the body shell until after weathering was applied. Consequently a little plastic solvent cement comes in handy to keep the assembly together until it is ready for the body shell.

This series of Monon cars was equipped with W.S. Tyler Co. vibrator

attachments welded to steel plates attached to the outer side of each hopper bay.

Although not totally accurate I made reasonable facsimiles from Evergreen styrene strip and sheet stock as shown in Figure 5. Since the hoppers are already painted ACC is the best adhesive for attaching the styrene vibrator brackets (Figure 6).

Body Shell

The body shell offers numerous opportunities to upgrade the model and these details are the most visible. The toughest part of the project is replacing the ladder rungs with .010 phosphor bronze wire.

Using a new razor blade and a new Xacto number 11 model knife blade, partially remove the molded on ladder rungs leaving the centers and the grab irons and rivets. Make a dimple below each rivet in the vertical posts and drill a number 78 hole in those locations. The remaining grab iron centers keep the vertical posts strong enough to accept the drilling.

Then proceed to remove the remainder of the molded ladder rungs with side cuts, the razor blade and the number 11 model knife. Follow the same process for removal of other grab irons. Accidental removal of one or more grab iron rivets is a definite possibility. They can be replaced by

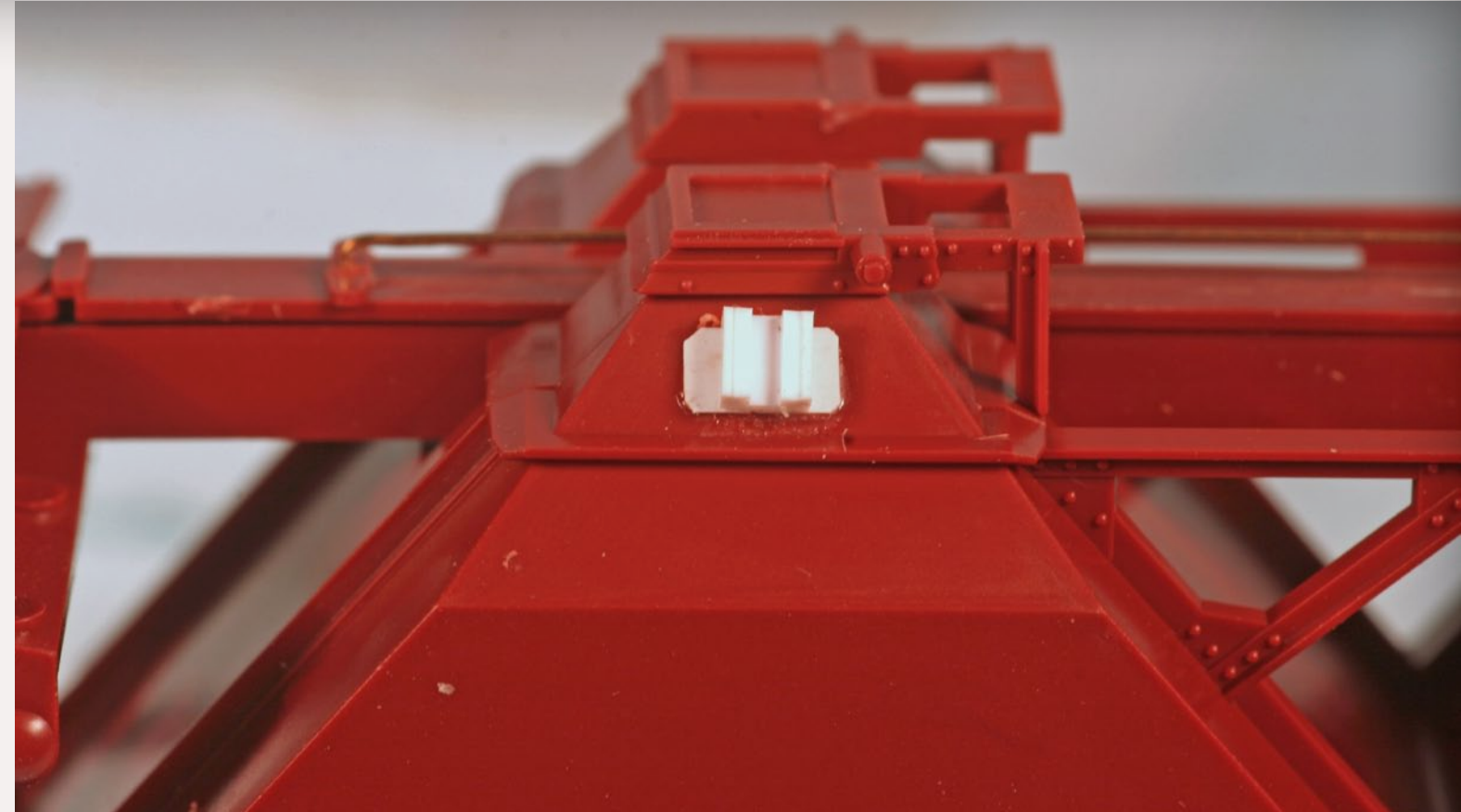


Figure 6: Vibrator attachments are easily scratch built from Evergreen Scale Models dimensional strip stock as described in Figure 1. Affix the vibrator attachment to the factory painted surface with ACC.

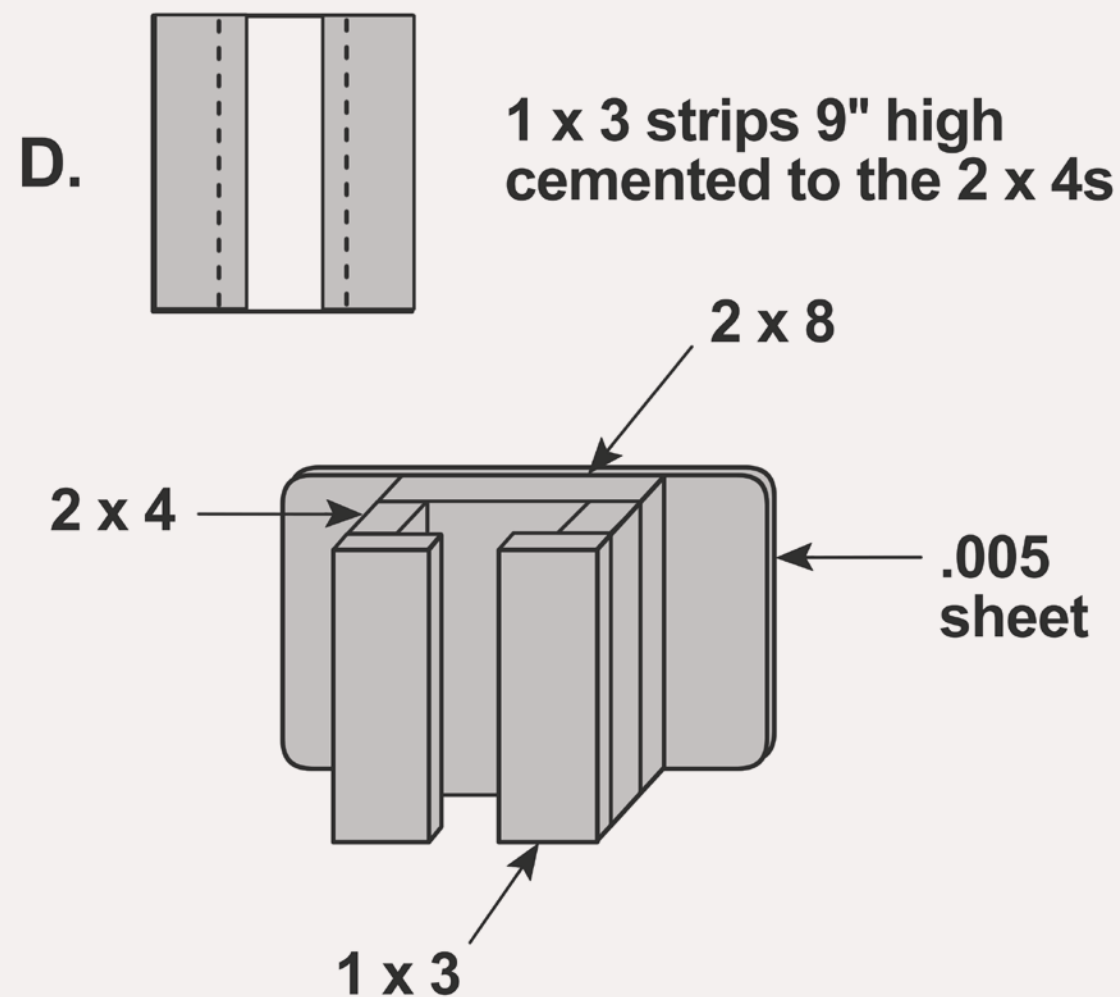
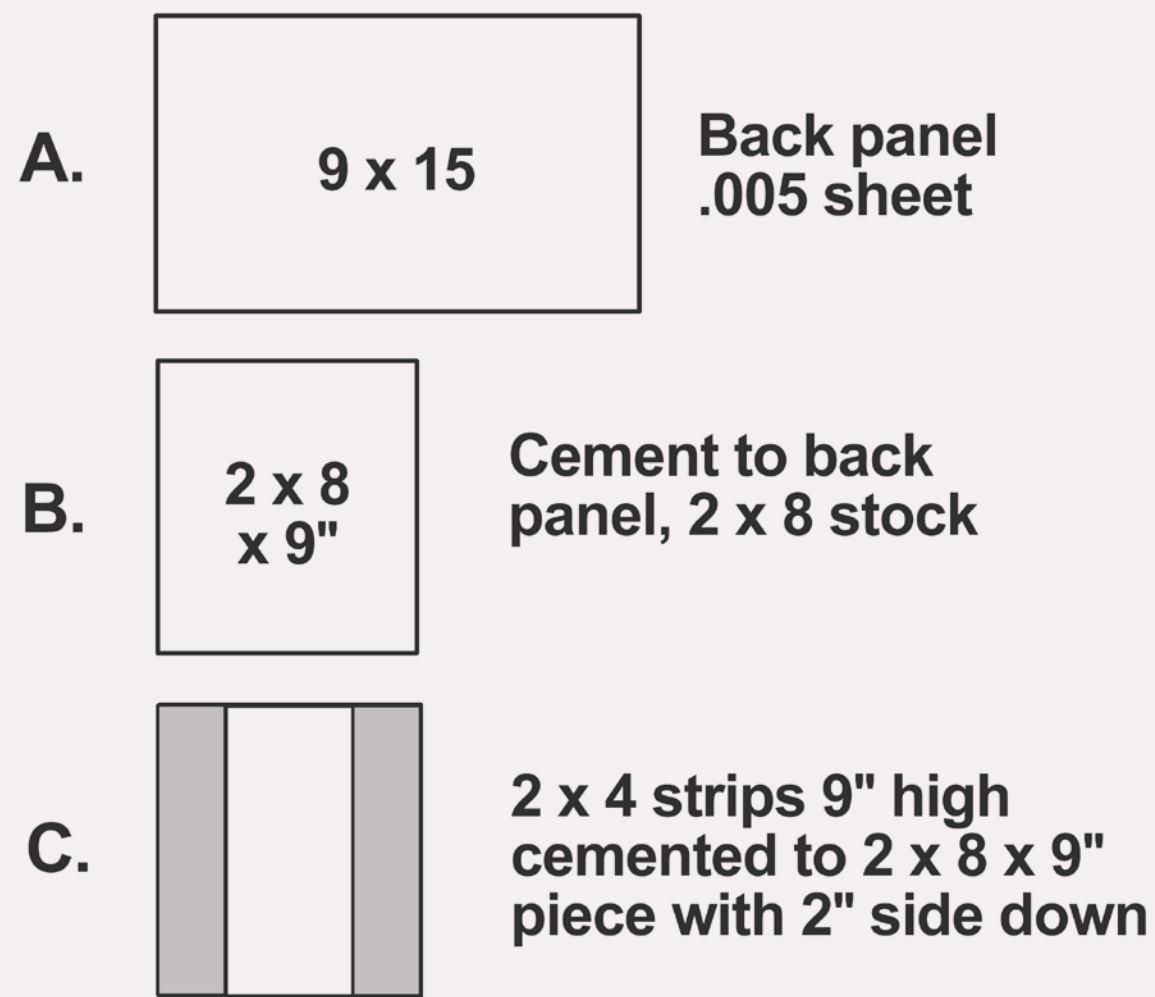


Figure 5: Cement these strips together in a length of 6 or more scale feet for ease of handling. Then separate with NWSL chopper every 9 scale inches.

Tichy .025 rivets in number 76 holes drilled next to its respective grab iron.

Now the model is ready for new .010 phosphor bronze grab irons. The new grabs must be bent to fit in the previously drilled holes. A simple jig can speed this up significantly (Figure 7).

The jig shown in the photos is simply a piece of .040 sheet styrene with a number 78 hole drilled the same distance inboard of a designated edge as the width of the grab irons.

To make the grab irons make a 90 degree bend in the .010 phosphor bronze wire with pliers. Then insert the grab iron into the hole. Holding the wire in place with the pliers bend the other end of the wire over the designated edge of the sheet. This yields "U"

shaped grab irons which can then be bent into a drop grab irons with pliers.

If your jig does not yield grabs that are a perfect fit you can adjust the width of the grab irons by notching the designated edge or adding a little material to it.

The sill steps furnished with the kit seem pretty durable, but they look heavy. Install the steps per the kit instructions. To make sure there is a solid joint add cement and clamp them in place until the bond is solid. Then slice the steps off even with the bottom of the side using a single razor blade.

Drill number 75 holes in the former step locations and insert A-line stirrup steps in them. Once correctly positioned using the prototype photos as a

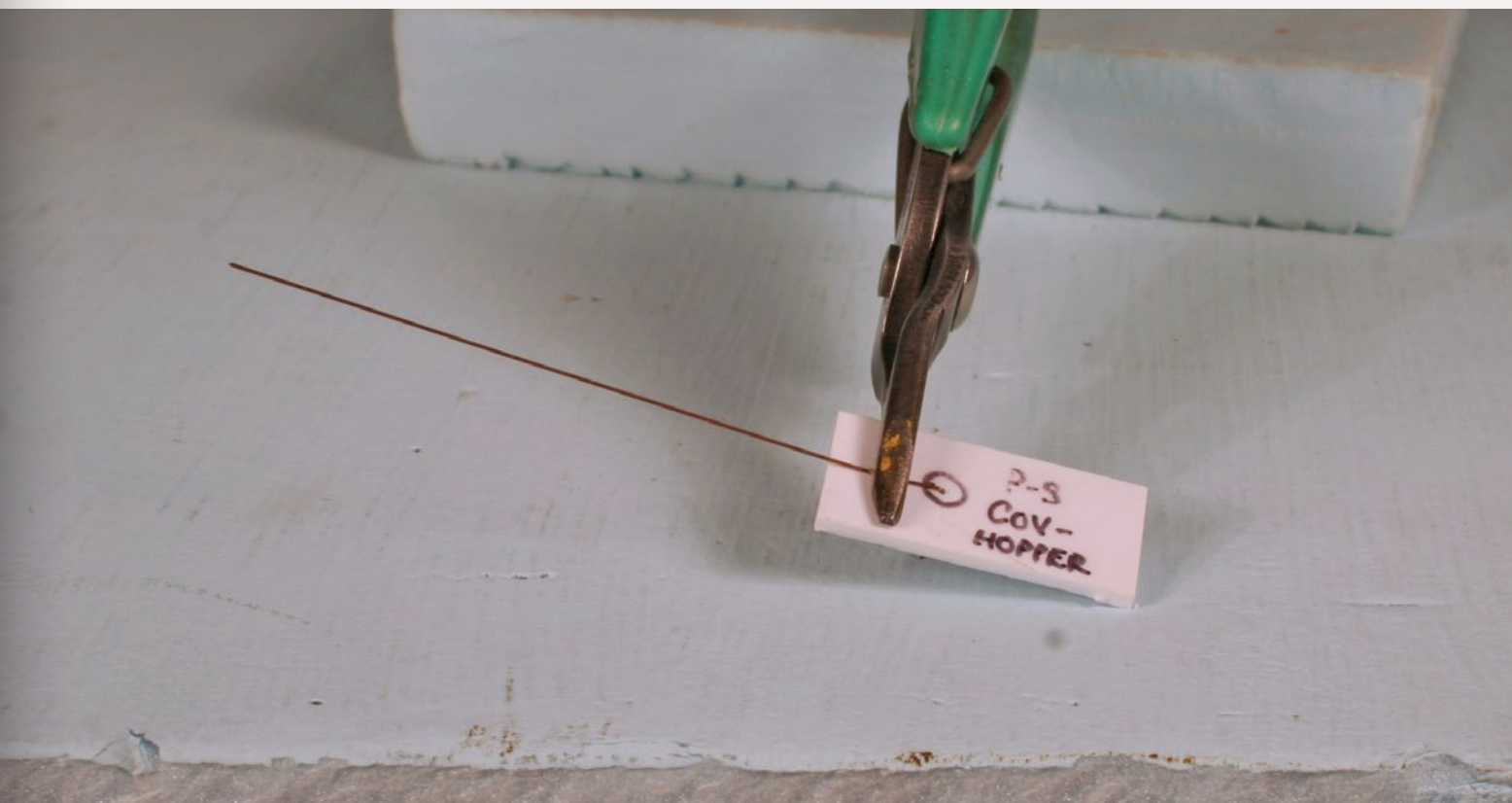


Figure 7: No less than 38 grab irons and handles must be formed to accurately detail this car. A simple grab iron bending jig can be made from a piece of sheet styrene with a hole drilled inboard the width of the grab irons to be bent as shown.



Figure 8: The train air line runs along the right side of the car when facing the "B" or brake end. The air line is made from .0125 phosphor bronze wire and is held in place with Athearn handrail stanchions. Small eye bolts can be substituted for the stanchions.

guide secure the steps with ACC. This process allows you to retain the side sill rivet detail while gaining the durability of flat wire sill steps.

KATO has molded their car bodies to accommodate cut levers. Install Detail Associates cut levers in the usual manner using an eye bolt in the corner sill at the handle end of the lever. With the lever in place use it to designate the location of a number 78 hole in the end of the coupler pocket cover to accept the coupler end of the cut lever. Secure these details with ACC leaving the impression that the cut lever actuates the coupler from the bottom.

The prototype cars have a side sill mounted train air line. This detail is not addressed on the model. Cut a piece of .015 phosphor bronze wire 27

scale feet long. Bend two feet on each end 90 degrees in the same direction. Then locate four mounting brackets (left to right) near and under the first, third, fifth and seventh vertical posts using the prototype photos as a guide. The brackets are made from Athearn handrail stanchions mounted in number 68 holes drilled in the bottom of the side sill. The air line is allowed to remain loose in the brackets to facilitate assembly of the body shell and under body (Figure 8).

The model also lacks towing loops. Located on the side sill near the bolster ends these loops allow for the attachment of a chain or cable for moving the car by means other than coupling to it with a locomotive. Detail Associates Alco lift rings make good towing loops. (See Figure 9 next page.)

Make drilling dimples in the bottom of the side sills with dividers approximately 12 inches outboard of the bolster ends. Drill number 78 holes and insert the lift rings securing them with ACC. Then add Tichy rivets on both sides of the newly installed towing loops.

The air hoses on the prototype cars are attached to each end of the train air line which seems to be held in place by U bolts attached to the lower side of the end sills. These U bolts go almost unseen, but the highly visible air hoses need support. Again the Detail Associates Alco lift rings come to the rescue. Install them in the end sills to the right of the coupler pockets in the same manner as the towing loops.

Secure the air hose brackets with ACC. Then insert the air hose casting in the U-bolt and ACC them in place. These details are subject to damage in handling and should be saved for late in the project.

Upgrade the roof hatch details prior to their installation on the car roof. Shave off the molded on grab irons located on the roof hatches leaving the rivets. Locate holes for the replacement grab irons just inboard of the molded on rivets.

Drill the holes with a number 78 drill and bend new grab irons from .010 phosphorous bronze wire to fit using the same bending jig technique described earlier in this article. Should you accidentally shave off a rivet or two

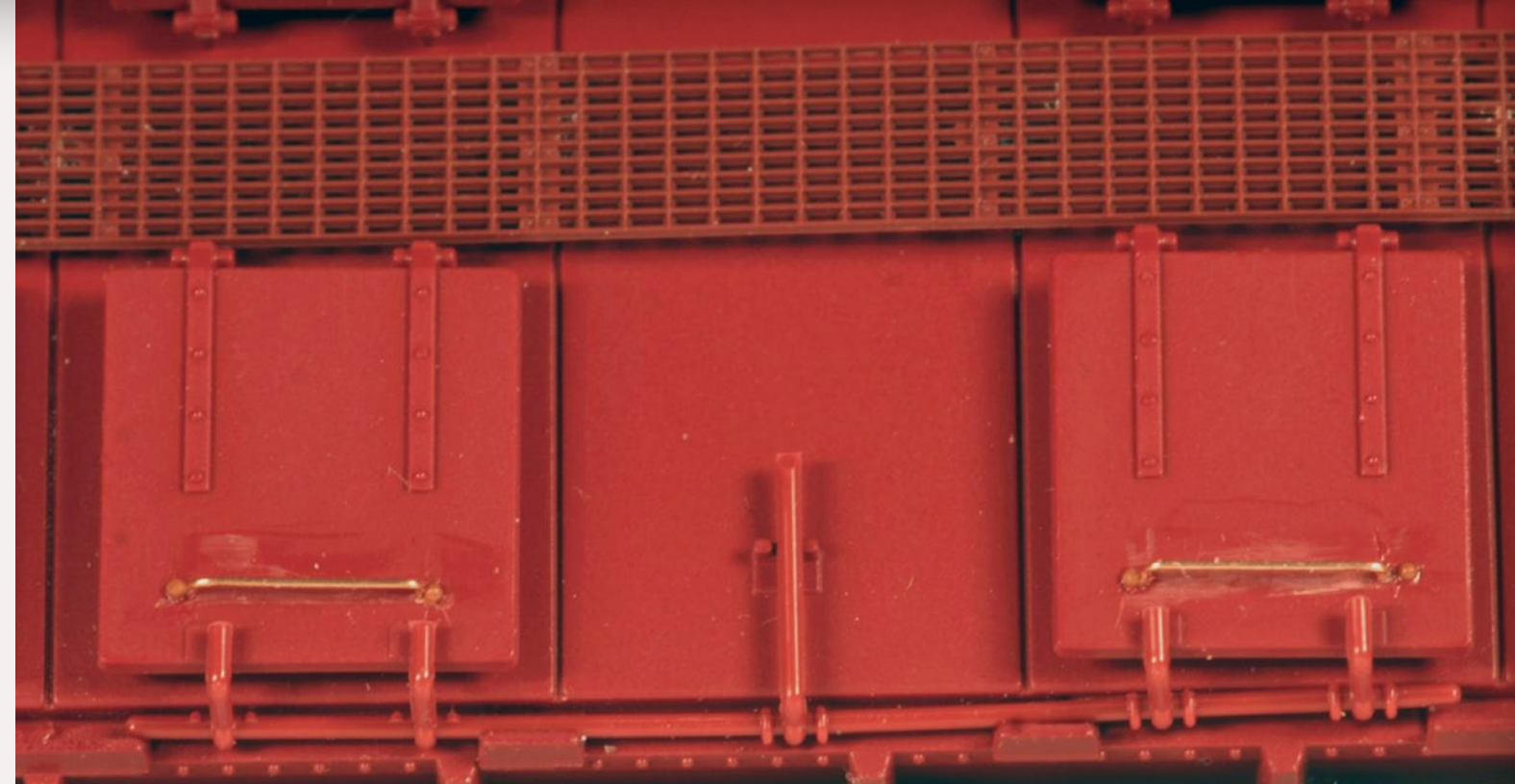


Figure 10: Many models are viewed from the top thus making these details of high importance. Shown here is one of the roof hatch handles that has been replaced with .010 phosphor bronze wire. Preserving the cast on rivet heads while chiseling off the grab irons, is difficult. They can be replaced with Tichy rivet heads in number 76 holes drilled next to the new hatch handles.

replace them with Tichy .025 bolt heads (Figure 10).

Once the newly detailed hatch covers have been installed add Kadee see through running boards. This state of the art plastic part is used on Kadee's excellent line of freight cars and are available separately. Cut them to length using the running boards furnished with the kit as a guide. Install these new details with ACC.

I was pleasantly surprised to find that the corner platforms come with nicely detailed corner grab irons and the end braces are molded in place. This well done Kadee part allowed me to avoid two normally tedious fabricating tasks.

A bonus from the running board detailing process is the left over see

through running board material. Using the brake platform furnished with the model as a guide cut the left over running board material to the same size.

Install the new part in the proper location using ACC. It barely covers up the kit part mounting holes. Then fabricate and install triangular support pieces made from .020 sheet styrene again using a small drop of ACC to secure them to the painted surface on the car (see Figure 11 next page).

With most of the details added it is time to touch them up so they will match the remainder of the car. Scalecoat II oxide red is a good match for the Monon cars. Careful control of the air brush eliminates the need for most masking. Take this opportunity to brush paint the air



Figure 9: The newly added train air line is folded under the car side and secured with ACC. Also note the phosphor bronze towing loop that as added to the side sill. This is one of four such details added. The prototype cars were built by in March 1953 at on line customer Pullman Standard of Michigan City, Indiana as the nicely done factory painted lettering correctly depicts.

hoses Floquil grimy black and douse the glad hands with Bragdon rust weathering powder. Allow things to dry for a couple of days before continuing.

Since the model comes in only three different numbers and I was planning to operate a few more I tried renumbering.

No problem. Just carefully scrape off the digits you do not want and apply decals for the digits that you do want prior to weathering. Don't forget the end numbers located on the slope sheets.

The factory painted Kato car comes painted as it was delivered by Pullman Standard to the Monon in 1953. I wanted to change the reweigh date and appearance of the Load Limit (LD LMT)) and Light Weight (LT WT) to reflect a car that had been reweighed at least once since it had been built to better represent my 1958 operating era. Several steps are required to achieve these effects.

First, simply cover the LD LMT and LT WT numbers with masking tape. This protects the numbers and background during the weathering process. When



Figure 11: The Kadee Apex Tri-Lok running boards significantly improve the appearance of the roof. A bonus is that the left over material from the running boards makes a nice hand brake platform as shown. The Precision Scale Company retainer valve and .008 phosphor bronze supply line are new details not found in the original kit. These details and the wire grab irons make this model "state of the art."



Figure 12: The car number shown here was changed by simply scraping off the factory applied number with a model knife and applying the desired number with decals. Only the last two digits of the number shown here were changed. When a car is reweighed the Load Limit and Light Weight numbers are renewed along with the location and date. Since this data was included on the factory painted model all that is required to accurately represent it was to protect it with masking tape during the weathering process.

the tape is removed after the car has been weathered the numbers appear to have been freshly applied as if the car had been recently reweighed and the numbers repainted.

Second, prepare the model for a reweigh date and location that fits your operating scenario by applying a 6 x 18 inch piece of masking tape to the right of the data already covered by masking tape.

I wanted my car to reflect reweighing at the Monon's McDoel yard in Bloomington, IN which marshaled cars for two large southern Indiana cement plants served by the Monon. I there-

fore used the McD 9-58 decal from Model Railroad Supply decal set 301 which has numerous Monon reweigh location and date decals. You could also make this lettering up from the decal scrap box (Figure 12).

Once the new decals have set apply a protective coating of Testors' dullcoat over the entire car. This protects the new decals and provides a porous surface for application of weathering. Then apply masking tape over the new "McD 9-58" so when the weathering is complete it will appear freshly applied just like the LD LMT and LT WT numbers.

Remember the part about not assembling the body shell with under body? This is to facilitate weathering. In the dust laden environment of loading and unloading cement, sand, flour or clay the cars soon become covered with the dust of the products they haul (Figure 13).

Delaying final assembly allows the modeler to get the weathering into the recesses of the model just as the real dust finds its way almost everywhere on the prototype. Air brush the underside of the car with Floquil grime paint thinned 90% with their Dio-Sol thinner or lacquer thinner. Apply this extremely thin “weathering mix” in several light coatings until you see the color begin to change.

Apply the mix to the slope sheets and end details also. Add a similar mix of Floquil grimy black to the underside of the car to represent dirt and grime that accumulates in these areas usually due to wheel spray.

Continue modeling the weathering effects of cement spilled on top of the car during the loading process. For this we will use real cement available in small quantities at home improvement stores.

I first got the idea from a MODEL RAILROADER article written by Lance Mindheim that describes how to cast concrete bridges in HO scale using real anchor cement. I reasoned that this real cement would be just as good for



Figure 13: MON 4362 (roof view) shows that not all of the cement went into the cars during the loading process. The claws on the outer edge of the roof hatches hold them closed. When released the hatches open inward toward the running boards.



Figure 14: The finished, weathered model on the layout.

modeling the accumulated spillage seen on the tops of cars.

First remove the hatch covers. The covers don't usually see large quantities of spilled cement accumulate because they are open when the spilling is going on. Then apply a heavy treatment of Testors dullcoat with a brush around the hatches one at a time. Then sprinkle the cement onto the dullcoat.

Do this by scooping up a small amount of cement on the end of a Popsicle stick and then brushing it off so that it falls onto the still wet dullcoat. Brush any extra cement off of the model that does not land on the dullcoat and catch it for reuse.

Allow some cement to accumulate under the running boards near the hatches, also. The real cement first appears too dark, but it lightens as it dries in place. If not satisfied you can always change the color of the cement with the Bragdon weathering powders we will use on the remainder of the model.

The underside of the car around the hoppers as well as the open ends accumulated both cement dust from unloading and the dark road grime previously applied. Using a soft paint brush apply Bragdon ash gray weathering powder to the hopper outlet areas and over the end details including the brake details to represent cement dust (Figure 14).

BILL OF MATERIALS

A-line	29002	stirrup steps
Bragdon Enterprises weathering powders		
Detail Associates	1106	Alco lift rings
	6215	coupler cut levers
CMA		
	1100	.008 phosphor bronze wire
	1101	.010 phosphor bronze wire
	1106	.0125 phosphor bronze wire
	1102	.015 phosphor bronze wire
Evergreen		
	8204	2 x 4 styrene strip stock
	8208	2 x 8 styrene strip stock
	9005	styrene sheet .005
Floquil		
	110013	grimy black paint
	110073	rust paint
	110086	grime paint
Hi-Tech Details		
	6036	air brake hoses, rubber
Kadee		
	153	scale short shank couplers w/whisker springs
	2000	Apex running boards
REBOXX		
	WS20965	.088 wheelsets
Scalecoat II		
	2002	oxide red paint
Testors		
	1161	dullcoat
Tichy		
	8018	bolt head moldings

Weather the car sides in the same manner as the underbody. Overcoat the sides of the model with Bragdon ash gray weathering powder applied with the soft wide brush simulating cement dust residue.

Then apply additional weathering powder in the panels below the loading hatches where spilled cement is more likely to wash when it rains. Use dark gray weathering powder to represent the heavier accumulation below the loading hatches.

Cement with the help of Mother Nature is hard on steel freight cars and the paint intended to protect them. This is exhibited by rust streaks in certain locations most notably where metals are joined. Simulate this on the model with Bragdon light rust weathering powder streaks near and below the locking rod supports and on the hatch cover hinges.

The Bragdon weathering powders are formulated so that they harden over time thus not requiring an overcoat for protection.

The amount of weathering applied during this step is a combination of such things as the length of time since your car was painted, how the car has been used and even your own taste in the weathering of your rolling stock. It has been my experience that once a car enters cement service it will never look the same again.

With the weathering complete assemble the under body and the car body. Then secure the sill mounted train air line up under the side sill and touch up the paint and weathering if necessary. You now have a state of the art covered hopper with accurate paint, lettering and weathering.



Mont Switzer has been building scale models since high school, and has over 250 articles published in the hobby press. His home layout follows the Monon Railroad prototype. Mont is the President of Switzer Transportation Companies, Inc. and an officer in the Indiana Motor Truck Association.



Article feedback!
CLICK HERE for reader comments
on this article ...



Sergent Couplers

First Look

– by Jeff Shultz
Photos by the author

Sergent Engineering, a Knoxville, Tennessee based company, has been manufacturing a line of HO scale knuckle couplers since 1999. Representing a “bottom operating” Type-E coupler, Sergent couplers possess a more prototypical appearance and are smaller than even the #58 style Kadee coupler. Due to differences in their operation, Sergent and Kadee couplers are not interoperable. The coupler’s method of operation is covered by patent #6308845 (see this link for details: <http://www.google.com/patents?vid=USPAT6308845>).

The couplers come in 3 different working models – the EC87 “Compatible Shank,” the EN87 “Narrow Shank,” and the ES1P87 Steam Coupler/Pocket. Additionally, Sergent Engineering offers Frank



Figure 1: From left to right, a Kadee 148 “whisker” with #5 head, a Kadee #156 “long shank” with #58 head, and a Sergent EC87A.

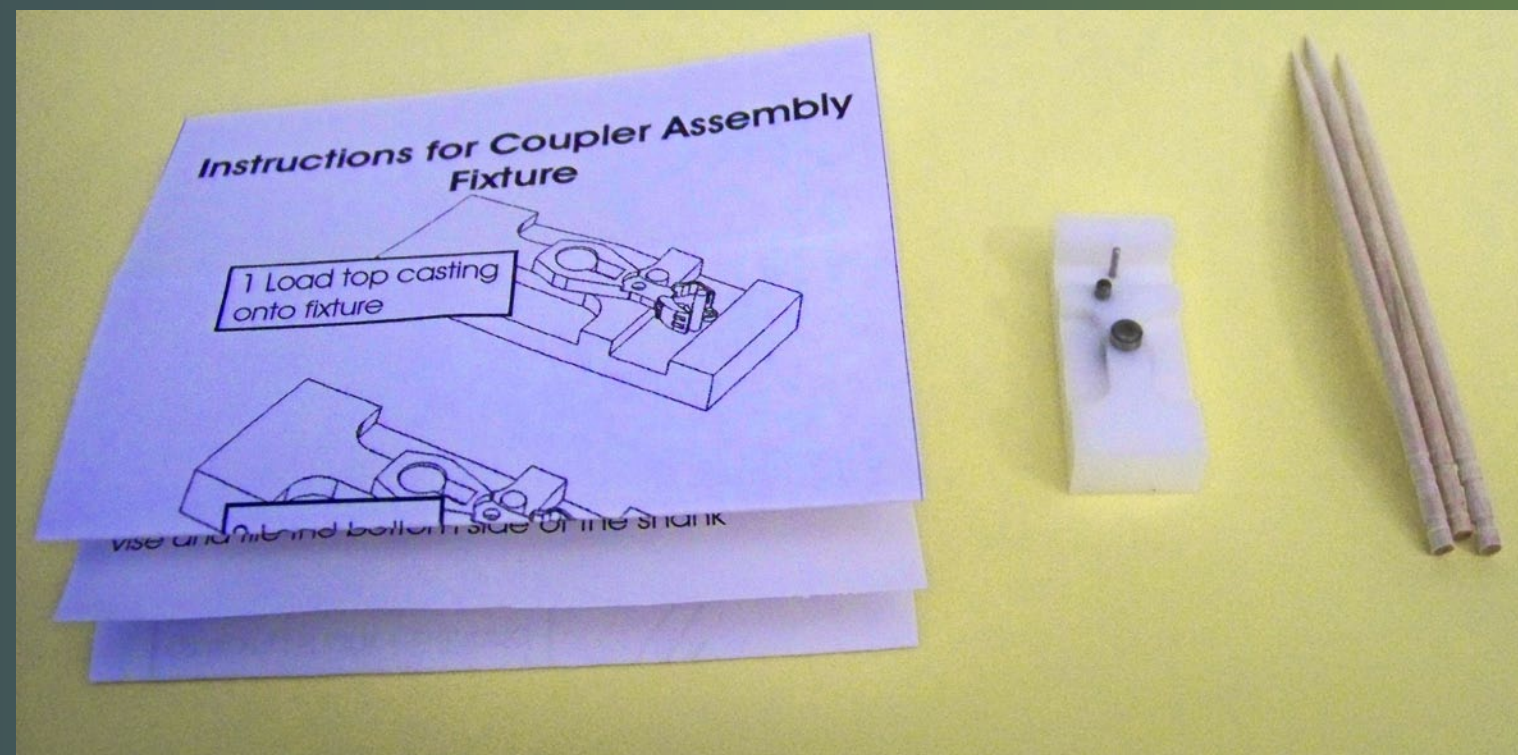


Figure 2: AFC coupler assembly jig with instructions and removal toothpicks. Used with EC87K normal shank coupler kits.

Glatz’s operational rotary and dummy couplers, both of which are compatible with the working Sergent couplers. The rotary coupler is a dummy head coupler mounted in a special rotary draft gear box.

The EC87 and EN87 couplers are available both assembled and as kits. The ES1P87 is only available as a kit. Assembly jigs are available for both the EC87 and the EN87 – called the AFC and the AFN respectively.

The AFC and AFN assembly fixtures are not interchangeable, being sized specifically for either the compatible shank or narrow shank couplers. The fixtures includes some toothpicks, to pry the coupler out of the fixture after gluing. Additional detail parts include the BCL87 brass cut lever linkages (cut levers not included) that fit into slots on the bottom of either the EC87 or EN87 couplers. For those who want “top operating” type-E couplers, Sergent Engineering will drill #80 holes in the top of the couplers for an additional fee.

The couplers are die-cast in a non-magnetic zinc material with a rust colored finish. They consist of four parts – the top, bottom, knuckle and the steel ball that holds the knuckle closed. When a magnet is

applied to the top, the steel ball lifts into a recess and the knuckle opens when outward pressure is applied.

Sergent makes an uncoupling tool called the "MS" that consists of a wire attached to an industrial magnetic rod – while the magnet pulls the steel ball out of the way, the wire is used to open the knuckle and move the coupler into alignment with the opposite coupler.

There are no springs involved with the knuckle other than one that is inserted in the shank against the draft gear post in order to add some friction to the swinging action.

The EC87 coupler shank is sized and shaped to install in most of the draft boxes on HO Scale equipment, and the EN87 coupler shank is sized to fit in the Accurail® PROTO HO scale size



Figure 4: EC87A compatible width shank from the bottom, mounted in an Atlas locomotive coupler box.

draft gear box (included with the EN87 coupler package).

The EN87 also fits in molded on scale size draft gear boxes such as the one on the Athearn Genesis Trinity Covered Hoppers and they fit well in the first run of the Intermountain MaxiIV intermodal well cars.



Figure 3: Combined AFN and IFN narrow shank coupler assembly toolkit. Includes the AFN jig for assembling the EN87K narrow shank coupler but also the IFN templates for mounting the Accumate P;87 prototype-width coupler box.



Figure 5: EN87K narrow shank couplers, pre-assembly. Pieces seen: top (with shank), bottom, and knuckle. Not shown: steel ball to lock knuckle closed and shank friction spring.

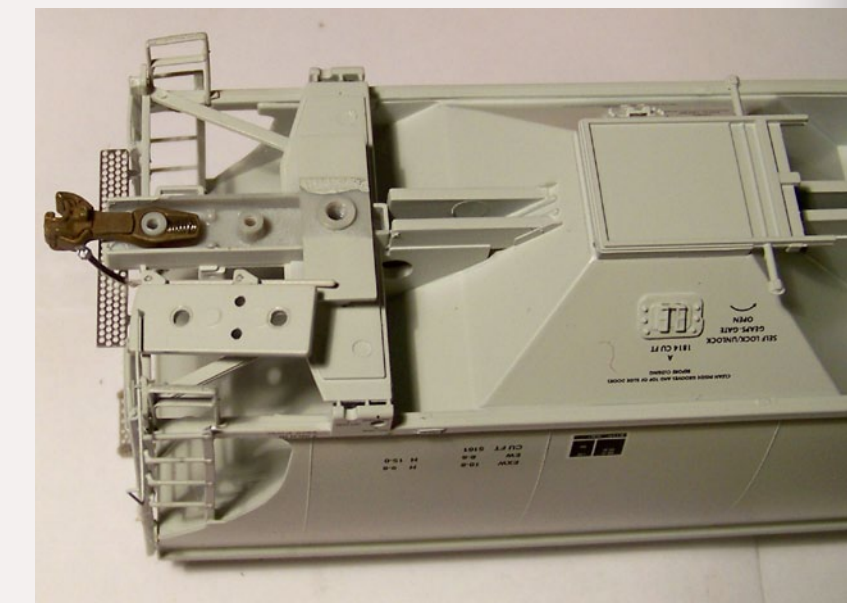


Figure 6: EN87K narrow shank coupler, assembled, mounted in Genesis Trinity Covered Hopper. Note friction spring against pivot pin.

 **Article feedback!**
CLICK HERE for reader comments
on this article ... 

The IFN Installation kit contains templates and a drill bit for positioning and mounting the prototypical width draft gear boxes on rolling stock.

Regarding coupling with Kadee-style knuckle couplers, it is possible for them to couple, but generally both couplers

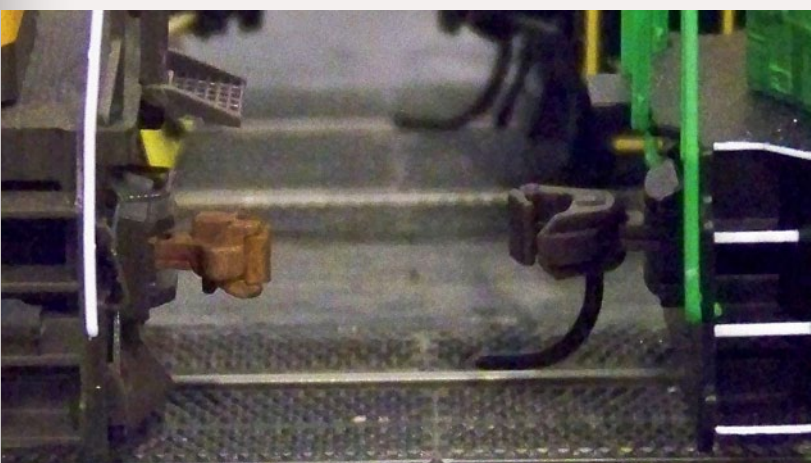


Figure 7: EN87A coupler mounted in an Atlas C425 (left) and factory installed Accumate coupler in a Trainman GP38-2. (right).



Figure 8: Kadee #148 coupler (left) in an Atlas GP38 and EN87A coupler mounted in an Atlas C425 (right).



Figure 8a: Kadee #148 coupler (right) in an Atlas GP38 and EN87A coupler mounted in an Atlas C425 (left).

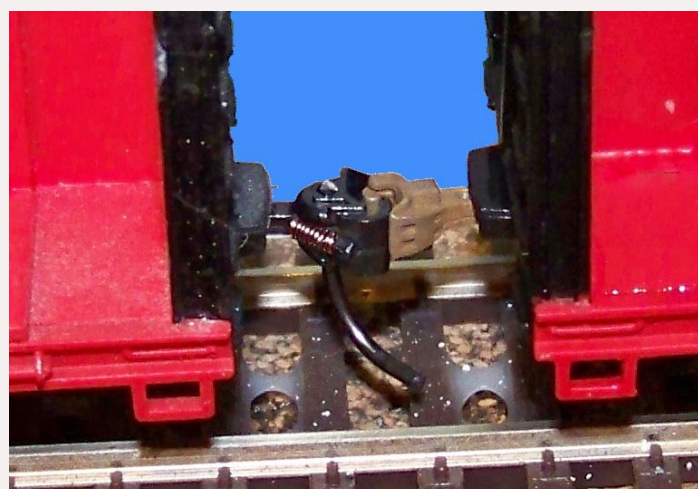


Figure 9: Kadee #148 coupler (left) "coupled" to an EC87A. Cars are Walthers 73 "Opera" Centerbeams.

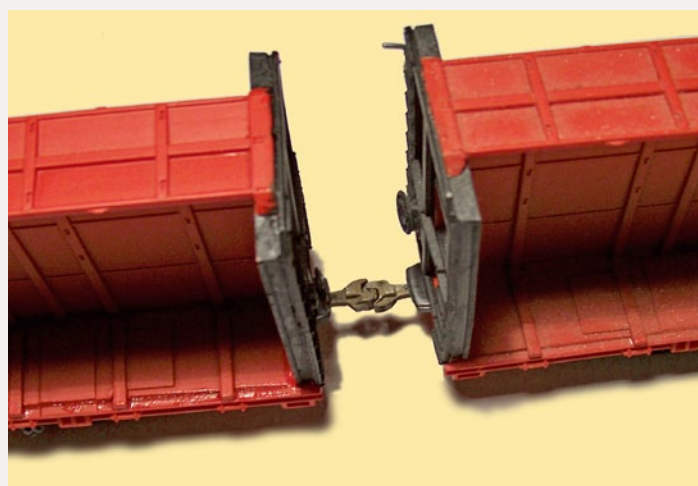


Figure 9: Two EC87A's coupled. Cars are Walthers 73 "Opera" Centerbeams.

are pushed to the right – and when your train hits a left-hand curve, the couplers generally can't go any farther right, forcing one of the cars to derail.

The EC87 is the second generation of the EC coupler – the first generation was not die-cast, resulting in a kit that, while somewhat more difficult to assemble than the current couplers, did clean up into a prototypical looking and working coupler.

Prices for the couplers and other items:

EC87A: \$7.00 for 4 assembled couplers

EC87K: \$7.00 for 6 unassembled couplers

AFC compatible shank assembly fixture: \$8.00

EN87A: \$11.00 for 4 assembled couplers

EN87K: \$9.50 for 6 unassembled couplers

AFN narrow shank assembly fixture: \$16.00

IFN Installation tools for narrow shank couplers: \$5.00

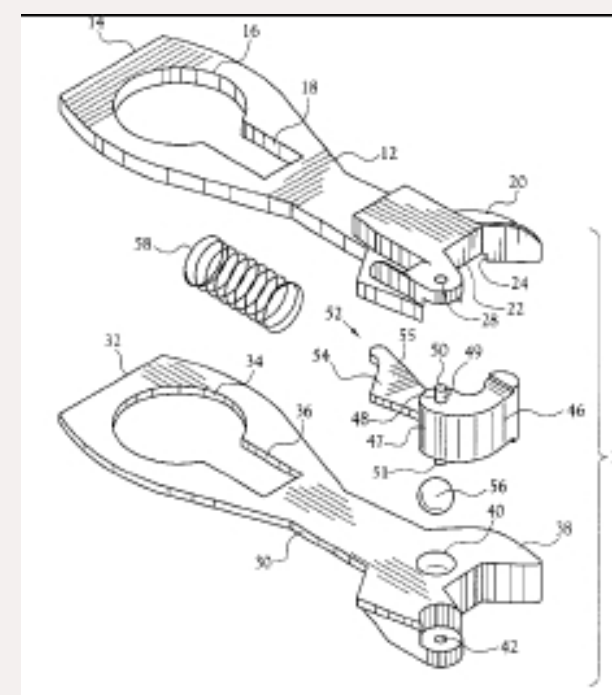
MS uncoupling wand: \$6.00

BCL87 10 Etched Cut Lever Linkages for EC87/EN87 \$2.00

DRLEN Drilled Top Option for one pkg EN87K \$1.00 Add 1 week for delivery.



Figure 10: EN87K's in a circle showing the details from various angles. All of them are "bottom" up.



Exploded view.

EN87K Assembly

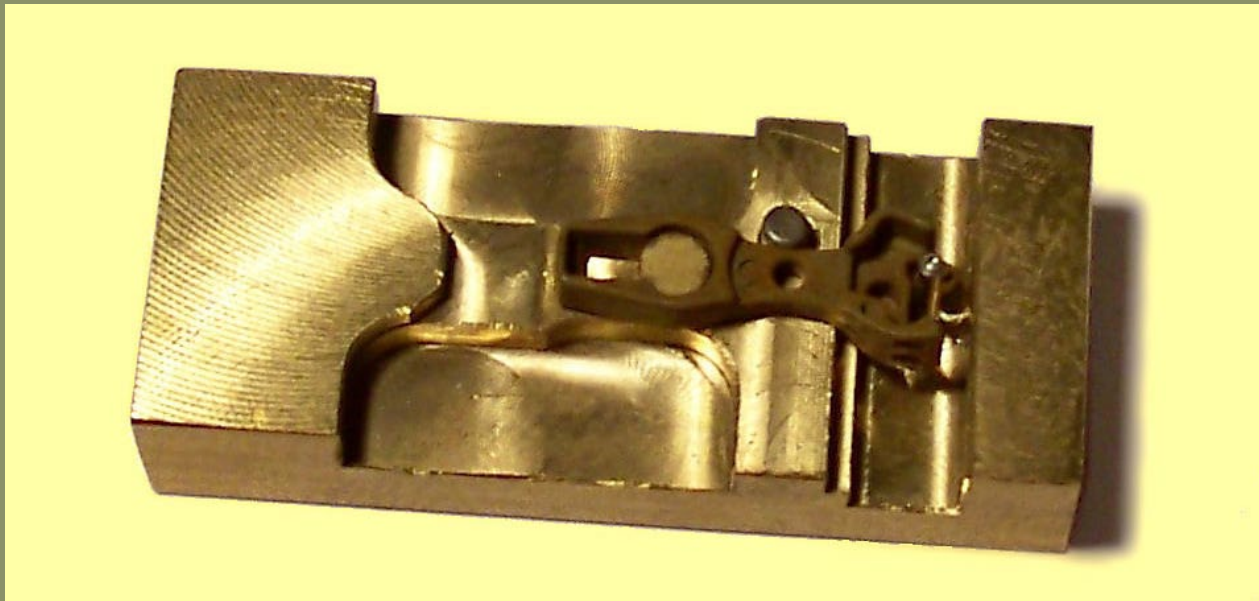


Figure 11a (Step 1): EN87K top in the AFN coupler assembly jig.



Figure 11b (Step 2): EN87K top with steel ball and knuckle in AFN coupler assembly jig.



Figure 11c (Step 3): EN87K completed coupler with bottom plate CA'd on.



EC87K Assembly



Figure 12 (Step 1): EC87K top in the AFC coupler assembly jig.



Figure 12a (Step 2): EC87K top with steel ball inserted. Sparkly stuff is Kadee powdered graphite lubricant.



Figure 12b (Step 3): EC87K top with steel ball and knuckle.

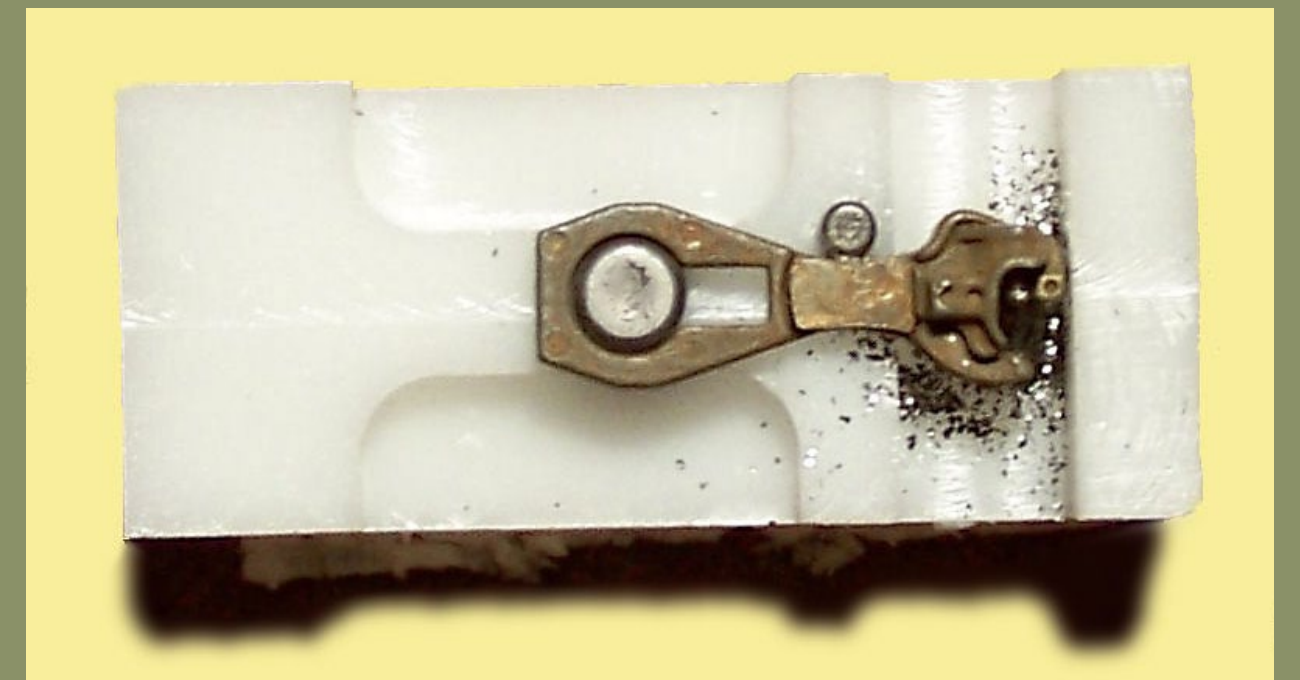


Figure 12c (Step 4): EC87K completed with bottom plate CA'd on.
Note: CA = cyanoacrylate, i.e. super glue

Sergeant Couplers: Installation and use

– by Josh Baakko
Photos by the author

I made the switch to Sergeant couplers in 2005. The big draw for me was the accuracy of the coupler, and reviews that stated they would stay coupled better. I originally ordered and installed some EC87K's. The K model comes assembled, thus saving me the time and effort.

One thing that **MUST** be noted, Sergeant couplers are not meant to be coupled directly to Kadee, or Kadee compatible knuckles, nor to the X2F couplers. They are made to their own nearly prototypical standard. They will only couple to Sergeants, or the Glatzl dummy and rotary couplers. My current solution for this cross platform issue is to store a few cars on my layout, which I refer to as “conversion cars” with a Kadee #58 on one end and the Sergeant coupler on the other.

Sergeant also offers the EN87, which comes with a closer to prototype shank, and an Accurail P:87 coupler box. Dummy couplers are available as well, and of particular note is a dummy knuckle, working rotation, rotary coupler. When combined with a Sergeant on the opposite end, you can build and run coal trains, and unload them properly while still coupled.



Figure 1: EC87 (left) and EN87 Couplers.



Figure 1: Coupler wand.

I found that installing EC87's is not very difficult. The toughest part is the friction spring. (Note: this is not a centering spring, rather just a means to keep the coupler from swinging side to side wildly). EC87's fit in most Kadee compatible boxes. Walthers boxes are notorious for not fitting the EC87's thicker shank, thus the shank must be filed down slightly, or replace the box.

Use of the Sergeant coupler is fairly hands on. When uncoupling, they are top operated, with a small magnetic wand, versus the trip pins on most production knuckle couplers. The wand has a small pin to help open the knuckles. At least one knuckle must be open to couple (though both open works much better), which is the same as a prototype coupler.

The friction spring mentioned earlier comes into play here. You can open the knuckle and set it slightly off center, to couple a car in a curve!

I hope you enjoy this install, and operation review of Sergeant couplers. I feel that they are one of the best innovations in our hobby, along the lines of DCC, and RailFlyer's locomotive building system. ☑

Installing an EC87



Figure 1: EC87 Coupler.



Figure 2: EC87 installed open.

Installing is straight forward. It works pretty much similar to any other coupler on the market, save for one part. The centering friction spring needs to be installed. I press the spring in using a set of tweezers. I found that being gentle with it is best. The spring will fly away if you bump the coupler!



Figures 2a and b: EC87 installed.

Installing an EN87



Figure 3: EN87 Coupler.

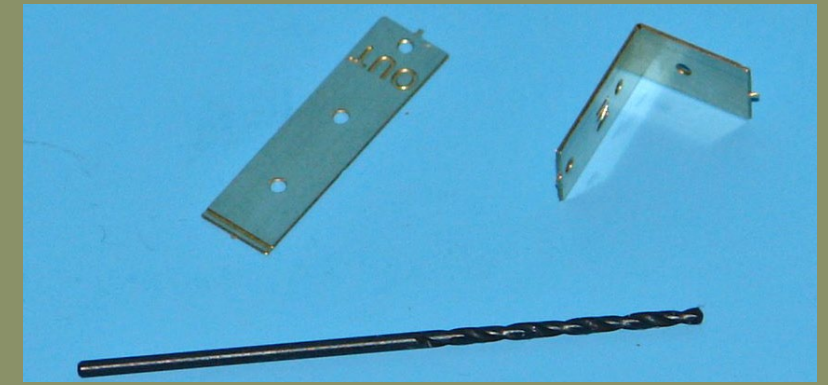
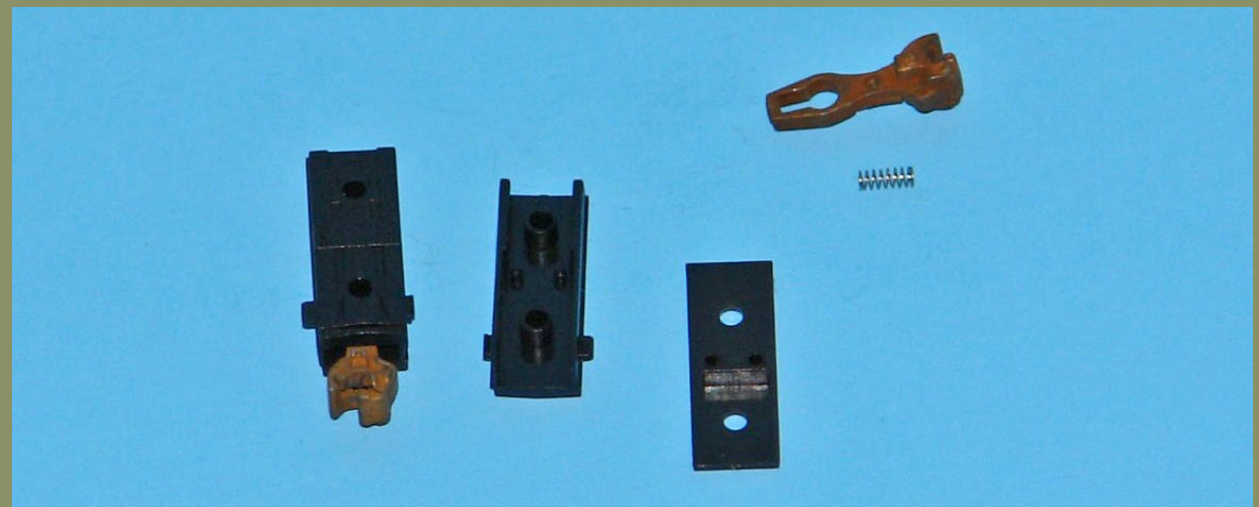


Figure 4: Drilling.

Installing an EN87 requires more work. If the rolling stock of choice has a cast on coupler box, it needs to be removed before you can continue. Accomplish this with a razor saw, or flat blade hobby knife vs an angled blade, ala #11 Xacto.

Sergent makes a drilling template, Sergent part "IFN". I strongly suggest buying this if you plan to use EN87's! Place the template on the model and secure it with clear tape. Drill the mounting holes, for 0-80 screws. There are two options on the template, two hole, or one hole. If folded, the two hole side lines up the front of the coupler pocket to be flush with the end of the model. For extended pockets, move the template out.

Once drilled the pocket can be screwed in place with the screws included in the EN87 pack.



Figures 5: EN87 with P:87 Accurail boxes.



About our narrow gage and branchline columnist



Lew Matt is a published writer, photographer, and illustrator.

[Click here](#) to learn more about Lew.

Photos and illustrations by the author unless otherwise credited.

THE LITE AND NARROW: Plausible freight car design

Ramblings on Narrow Gage and Branchline Modeling

On30 Gondola: Imagineering a Generic Revenue Car

Generic Freight Car Design is another name for the concept of plausibly designing and building a free lance car for a fictitious narrow gage railroad. Since On30 railroading is essentially fictitious with most of the model railroads freelanced. The concept of strict adherence to Colorado Southern, Rio Grande Southern or East Broad Top prototypes and practices in On30 becomes an exercise in personal preference, not prototypical modeling.

I like the idea of being free to create what we want rather than be limited to exactly what the prototype did, and On30 serves us well in that regard. (My apologies to all the faithful 3 foot and 2 foot gage prototype modelers if my personal philosophy rubs you the wrong way.) Sometimes reality mixed with a touch of whimsy results in a great model.

Now for the paradox! Considering the freelance concept as stated above, the first thing to do to create a particular kind of railroad car is look at what the prototype railroads did. A fictitious car does not have to be improbable; in fact, the more probable it is the more you and everyone else will like it. When disregarded, the laws of physics and engineering create glaring and obvious holes in our freelance world.



FIGURE 1: The Lancaster, Oxford and Southern train crew perform maintenance on gondola car number 456 prior to leaving the siding. This is a simple and effective scratchbuilt flat/gondola car that can form the core of a fleet of similar revenue cars for your narrow gage railroad. Many of the parts for the car were made by the author, not purchased, to keep the cost low and add model building interest to the hobby. Unless the car is planned as a contest entrant, extreme precision and adherence to the prototype is not necessary. Slight variations in the construction design add to the charm of the freelance car.

If we stick to what works in the real world, the fictitious miniature world becomes more believable. I consider

myself an average model builder and don't enter model competitions very often. If my creations are plausible and

have few glaring problems, I am satisfied with the results. It is difficult to see all the detail when you are operating cars on the layout, and the general impression conveys perfection.

The mass of cars and locos in On30 is not the same as that of the standard gage and class one 3 foot lines. A slight reduction in size and shape or volume lends more credibility to models in this gage and scale than full size 1/4" = 1' - 0." Building On30 cars close to S scale, 3/16" = 1' - 0," renders the On30 car to appear more believable.

When I find a well designed standard gage car I wish to reproduce in On30, I take a drawing of that car and reduce it 70% to 80% to get a feel for its narrow gage mass. If it still looks credible when reduced, then I design the car

model to that size. This is essentially the process I used to build my Lancaster Oxford and Southern gondola and other revenue cars.

Designing and building a fleet of revenue cars for your railroad depends on what the railroad does for its living. Railroads catering to mineral extraction need ore, hopper or gondolas; petroleum haulers need tank cars, and grain shippers need covered gondolas and box cars equipped for grain hauling etc. The road's needs determine the revenue cars to build.

The Lancaster, Oxford and Southern hauled farm related products and general merchandise through the rugged Susquehanna River hills and the gently rolling hills of the Pennsylvania Dutch country of southern Lancaster County, Pennsylvania.



FIGURE 2: The boards on the end were stained and painted individually before construction to ensure randomness in the color. Note that the brake airline hose has yet to be installed.



FIGURE 3: The vertical brake shaft and wheel were made from piano wire and a brass casting soldered together for strength and reserved as a sub assembly for later installation. The wood deck was distressed and stained to show wear and a brake staff ratchet and pawl from the junk box were CAed in place. The brake airline hose has yet to be installed.



FIGURE 4: The sides of the gondola were assembled on the workbench from prestained scale lumber, model airplane style, over a wax paper protected drawing and held together with pins. Details were added, such as plastic nut bolt washer castings, card stock stake pockets and wire grabirons while the sides were laying flat. Small bolts connecting the stakes to the boards were made from dark brown ink dotted in the correct place with a #0 technical pen. The arch bar trucks shown here have HO 36" diameter metal replacement wheel sets with the code 80 semi-scale tread.



FIGURE 5: The boards and lumber for this car were pre-cut to size and stained before construction. The stain was concocted from mild acetic acid (photo stop bath) into which iron filings were dissolved until the acid was neutralized by the iron. The resulting red stain colors the wood deeply and is an excellent base for a gray weathered stain and “peeling” paint drybrushed over. The steel corner plates, used to tie the sides and ends together were made

from 3 x 5 cardstock that was stained like the wood, impressed with a riveting “needle” and then cut out and applied with white glue. The car was painted with Floquil paints and lettered with decals, rub-off transfers and hand lettered with a white charcoal pencil and white ink in a technical pen.

This type of railroad would need box-cars for general merchandise, bagged grain, bagged seed, tools, Sears' house kits, bagged cement, lumber and miscellaneous LCL deliveries; refrigerator cars for milk and fresh vegetable and fruit hauling; gondolas for general merchandise, coal, machinery, pipe, farm products and equipment; flat cars for machinery and lumber; ore cars for the local silver mine's unrefined ore, tank cars for kerosene and gasoline, and a few hoppers and gondolas to deliver limestone and anthracite coal to the wholesalers.

FIGURE 6: The B end of this as yet unfinished car, sports an extra vertical structural piece to which the brake platform will be attached. The other end of the car has only 4 vertical structural members. This car will look more appropriate for the era with a vertical brake staff. The K brake detail parts will go inside the car under the slope sheet with piping made from brass and soft iron wire. The right side of the car will have an exterior brake air line running just under the side as was found on the USRA 55 ton hoppers. The airline, suspended from three Athearn handrail stanchions will make a nice detail touch.

To satisfy initial operation requirements, the construction roster would include three 10 ton flat cars to start: one with sides - a gondola, one with a tank mounted, and one with a plain deck; a 20 ton refrigerator car; three 30 ton box cars; three 8 ton ore cars; two 10 ton 2 bay hopper cars, and a combine car for baggage and passengers.

This would be the bare minimum number of cars needed for the 12' X 2' switching railroad loosely based on the track plan from the "Switching Problem of West Agony" that appeared in MR many years ago. The flat cars, as



FIGURE 7: This picture clearly shows how an HO flatcar was split into three pieces to ensure rigidity of the finish car and that the truck bolsters and couplers are at the correct height. The sub-deck, to which the three pieces of HO flat care are glued, is a piece of sheet lead .030" thick. The lead sheet, the length and width of the finished car, became the subdeck with the HO frame attached on the bottom and the finish deck of individually applied boards on top. This made a rigid platform and added mass and weight to a style of car that is notoriously difficult to weight correctly.



gondola, tank and flat, would all be the same basic design, the refrigerator and box cars would be based on their same design and the rest of the cars' designs would be determined later based on material at hand.

If the railroad ever had a beast of burden, it would be the flatcar in all of its permutations. The most common variation on the flatcar is the gondola, a flatcar with sides. The venerable gondola can carry almost all of the loads a flatcar can carry and in addition, it can carry loose or unsecured loads like dirt, ore, coal, coke, pipe, scrap metal, barrels, rail, ties etc.

Most of these items can also be carried on a flatcar if contained, staked and tied down properly, but that's the beauty of the gondola car, it doesn't require that extra step. For these and other reasons, I opted to start with a gondola car for my On30 freight roster.

Since my era is the early 1940s, the choice of preferred construction material is wood. Most of the narrow gauge railroads in America built flats, gons and other freight cars from wood so they could be built in-house and keep construction costs low. There are notable exceptions to wood for heavily used cars and/or high revenue traffic,



FIGURE 9: The HO car had a web on the side where the slope sheet ended at the side of the car. I chose to remove this with a file to make the side a more typical construction style. The frame was built up by adding a 1/8 inch thick piece of wood, the same width as the frame, to the top of the frame. This raised the car up just enough to be credible. Since the car has so many ribs, I considered removing every other one but the effort seemed to be too great for the small visual change. These cars should be very dirty and rusty as they are handled rough and used hard.



FIGURE 8: You can see on the inside where the car was widened along the centerline axis and the cut covered with cardstock pieced over the slope sheets and frame. When the car is loaded with a coal covered foam rubber insert, none of the interior detail is visible and the frame doesn't need covered. Some people may find the width of the cover to be too wide and choose not to do the cover up this way. Detailing and weathering of the slope sheets should include some streaks of shiny steel from the scouring action of the coal as it slides down the sheet.



FIGURE 10: The red life-Like HO 55 ton hopper from which I made the On30 freelance 10 Ton hopper shows the car was widened and slightly raised in height but not lengthened. This is a small hopper and will be pulled by a small critter. Too massive a hopper car would look inappropriate in its intended setting and use.

such as the East Broad Top Railroad's fleet of steel coal hoppers.

I searched for a prototype wooden gondola that would look at home on my layout. The most likely candidate was a standard gage Chesapeake and Ohio turn-of-the-century wooden gon that I redesigned to 75% of its standard gage dimensions and placed it on HO trucks.

(Note: I use HO trucks, not narrow gage 1/4" scale trucks for most of my designs because I believe that the main premise of On30" railroading is that it is cheap! I cut my eyeteeth in narrow gage as an early member of the Manchester Mini-bunch, pioneers of cheap railroading, using HO components and mechanisms for O scale models.)

I constructed the gondola car just as the prototype would by building a flat car and adding sides and ends. There

were several plastic, train set quality, HO flat cars in my junk box, so I chose to start with one of those. This would ensure rigidity, and truck bolsters and couplers at the correct height. The HO car measured out to 10' 0" in width and 40' - 3" in length. I wanted 7' - 6" in width and 20' - 0" in length in O scale. The length of the car would be correct in O scale, for my needs but to gain the additional width, I cut up and rebuilt the frame.

I used the sides of the flatcar and salvaged the main frame with bolsters and coupler mounts and elected to make two longitudinal cuts along either side of the center sill which divided the HO flat car frame into thirds along the length. A .030" thick lead sheet, the length and width of the finished car, became the subdeck with the HO frame attached. This made a rigid platform and added mass and



FIGURE 11: From this view you can see that no major changes were made to the car side, keeping construction simple and quick to do. I want to make several of these cars but don't want to invest too much time in the construction of the fleet.



FIGURE 12: The tank car built on a flat car uses the same "flat" construction as the gondola. The length of the car is 20 feet and the tank is from a junk-box Lionel O27 trainset car. The tank, based on the venting and the horizontal courses is the style of the 1920s and newer. A very modern car.



FIGURE 13: The tank car built on a flat car represents about a 6,000 gallon car. This type of car could be used to haul on-line lubricants and diesel fuel, even perhaps, gasoline. I will place this car, when completed, as a static model at a siding with a fuel depot and a tank truck or two. The hatch will be open showing the valve inside the dome and a discharge hose will come from the bottom of the car and go into the underground fuel storage area. Adjacent tracks will hold cars for operations.

weight to a style of car that is notoriously difficult to weight correctly.

I used Walther's Goo to secure the lead sheet to the three piece car frame, carefully aligning the edges so that the car was square and the truck bolsters were on the centerline. When the Goo was dry, I had a firm structure for the rest of the car.

New wooden ends and decking were created from individual scale bass-wood boards, Gooed to the ends and on top of the lead sheeting. I allowed the decking to go wild over the edges, but with only a little overhang. I like to pre-stain all of my boards, timbers and lumber before I glue them together so if I overdo the adhesive and the porous

surface of the wood is sealed, I don't have to worry about coloring the wood through the glue, the wood is already the right color.

Card stock and wire were shaped to form new stake pockets and fastened with CA to the sides of the HO flat car. The sides of the gondola were assembled, model airplane style over a wax paper protected drawing held by pins, on the workbench, from prestained scale lumber.

Details were added, such as nut-bolt-washer castings to the ends and sides, brake detail, queen posts, truss rods with turnbuckles and truss rod ends on the end sills. The vertical brake shaft and wheel were made from piano wire



FIGURE 14: The train crew is nearly finished with the maintenance on car 456. The gon can carry just about anything and make money for the railroad.

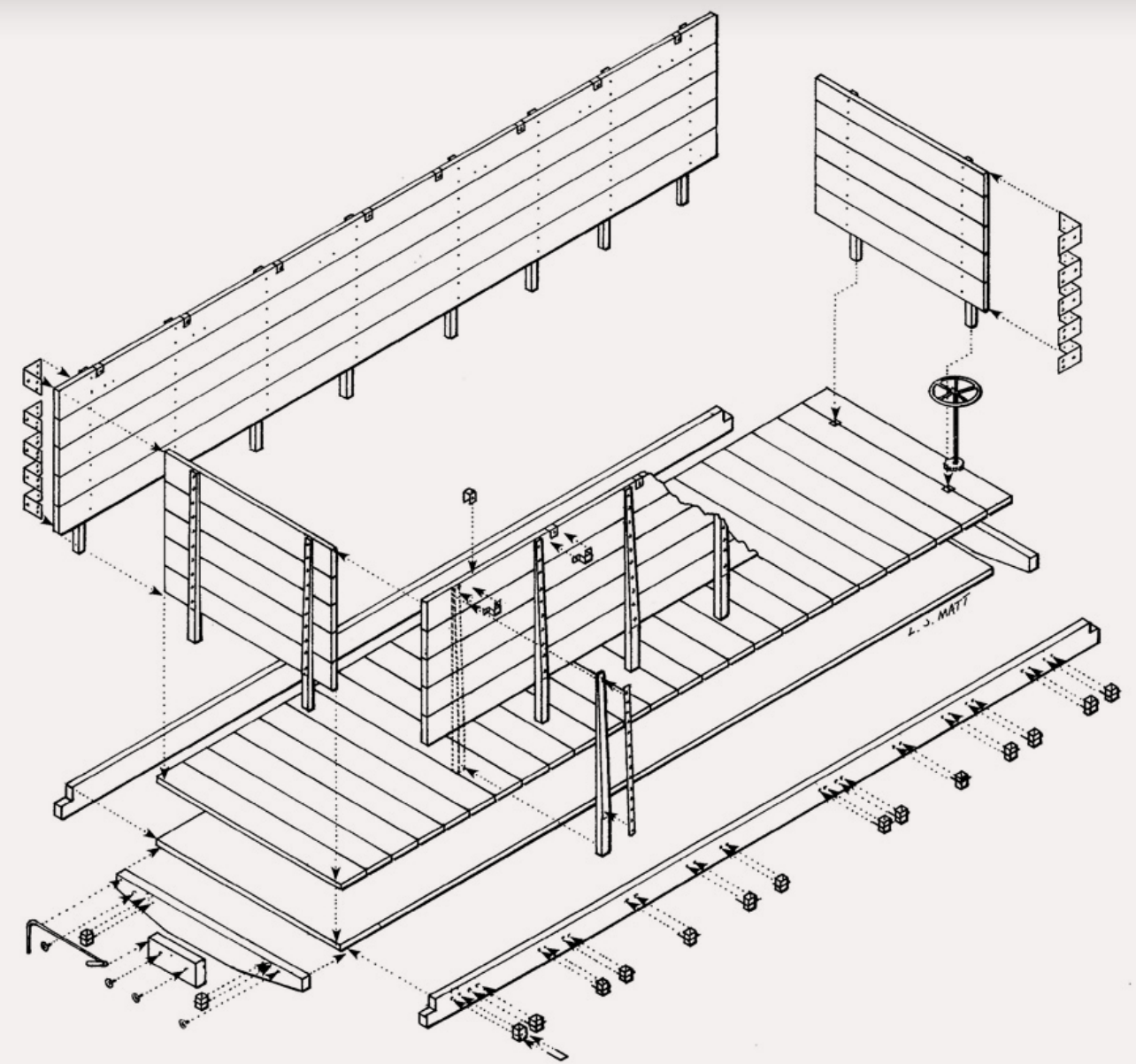


FIGURE 15: The elevations of the gondola car and the exploded view contain almost all the information needed to scratchbuild the car. The overall dimensions are open to interpretation and can be filled in for your specific design as you go. It is a lot more fun – and a lot less expensive - to make your own detail parts than to buy castings and preformed wire grab irons and steps. The flat car's stake pockets are simple to make from 3 x 5 recipe cards card stock. Whenever a thin strip material is needed, such as the stake pockets and corner braces, try index card stock as it is easy to work with and takes rivet impressions well. Scale lumber for the flat car decks was made from scraps of salvaged veneer, but even balsa or coffee stirring sticks would work. Steps and grabirons are paper staples. Use your imagination.

and a brass casting soldered together for strength (I am awfully clumsy and break brake wheels off all the time) and reserved the sub assembly for later installation.

Fine underbody details were neglected because the car sits too low to see this area, but the "K" brake cylinder was added because it hangs down enough to be seen. The wood deck was distressed and stained to show wear and a brake staff ratchet and pawl from the junk box were CAed in place.

The car was painted with Floquil paints and lettered with decals, rub-off transfers and hand lettered with white ink in a technical pen. A white charcoal pencil was also used.

KD couplers, HO Crown trucks with brake beams fashioned from scrap wood and chain, the preassembled brake wheel and the car sides and ends were added and painted as needed. The car was weathered with paint, chalk, pastels and thinned black wash, then sealed with Floquil flat finish. The

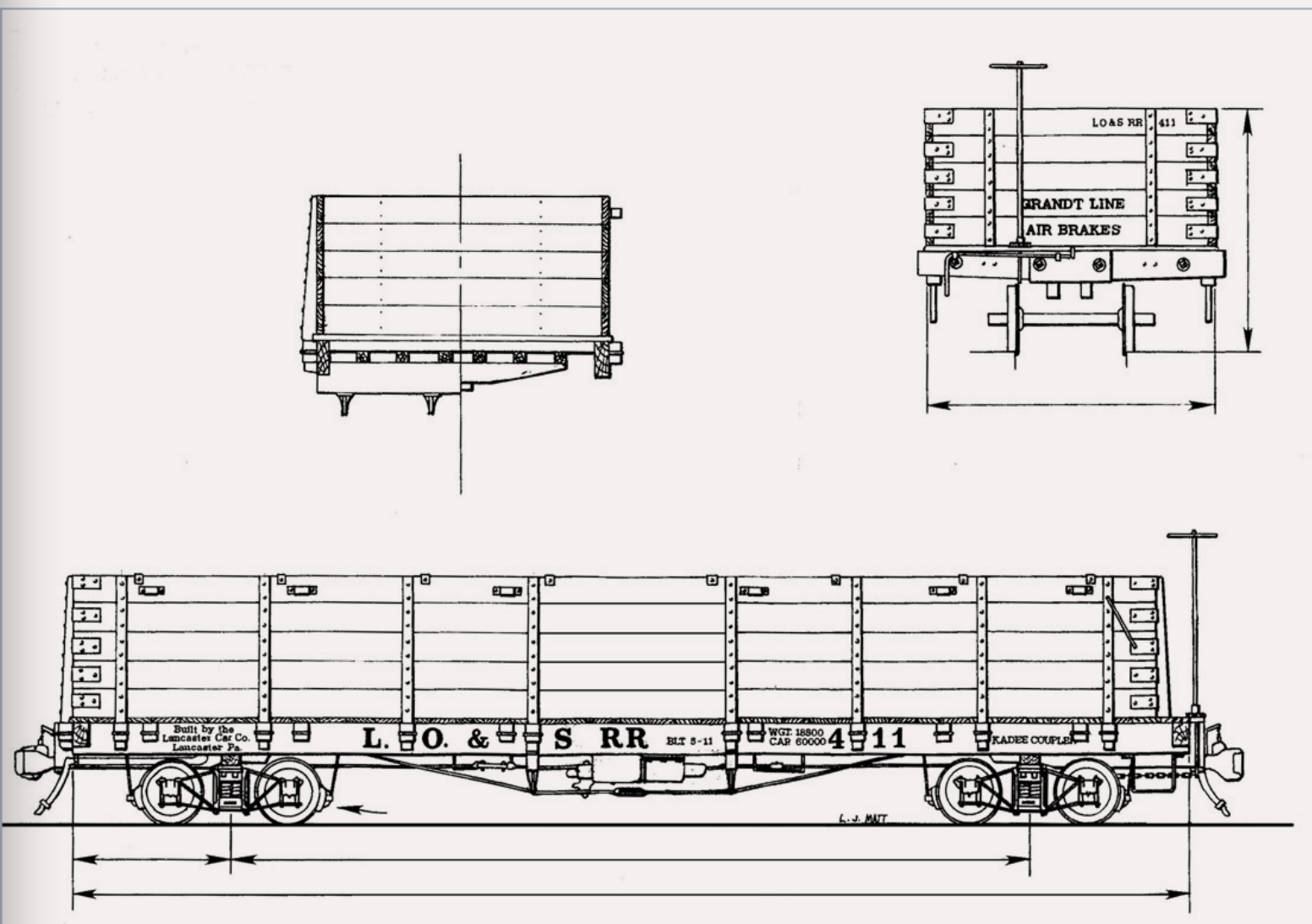


FIGURE 16: Fill in the dimensions on this drawing once you have determined what material you will use for your car. I sometimes forget to orient the correct end of my brake cylinder with my brake staff. Double check each piece before you glue.

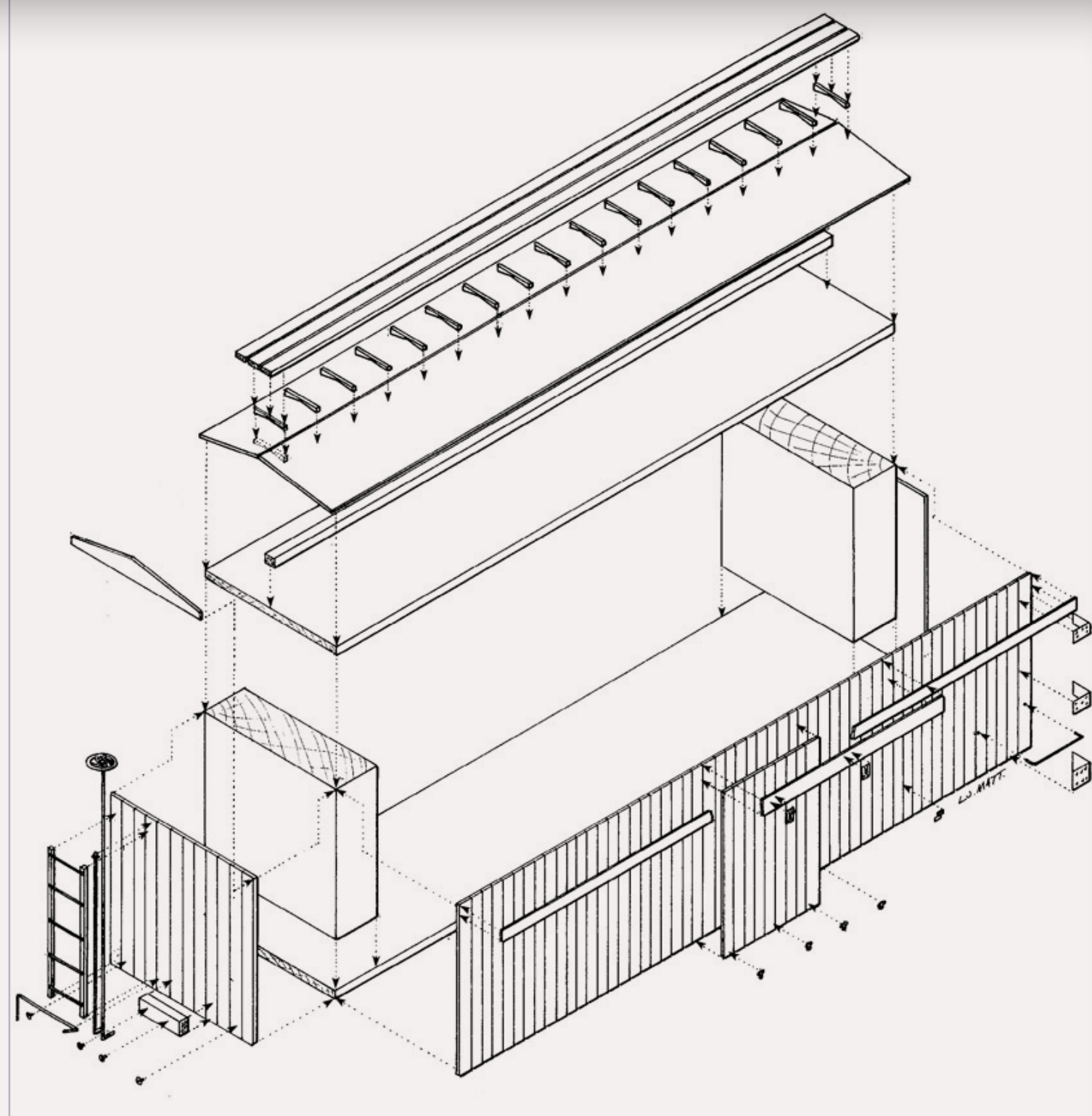


FIGURE 17: The dimensions are open to interpretation and can be filled in as you decide on the style of your car. This drawing is typical of a 30 ton box car and a 20 ton refrigerator car. The construction technique of the box and refer cars is the same design used for the old printed paper sided car kits that were the norm when I was a kid. The blocks of wood at either end make the car extremely sturdy. Watch the weight of the blocks so you don't make a car that is too heavy. Use soft wood for the blocks to facilitate installing the grabirons. Ladder stock may be substituted for the right hand side and end grabirons. I use grabirons and a drilling jig to keep the cost low and installation easy. Index card stock makes excellent corner braces, as do paper staples for steps.

lettering was rub-on transfers. I found a solvent that dissolves the brand of lettering I have and used it to soften and drag the color away from the dry transfer as if it were washing off the car from the weather.

I first planned and installed HO arch bar trucks under this gondola, but they

looked too light weight and flimsy. I later opted for HO Crown trucks as they have a bit more mass that conveys the impression of strength and durability, however, the actual type of truck in use fluctuates seasonally as my tastes change.

I use HO 36" diameter metal replacement wheel sets with the code 80

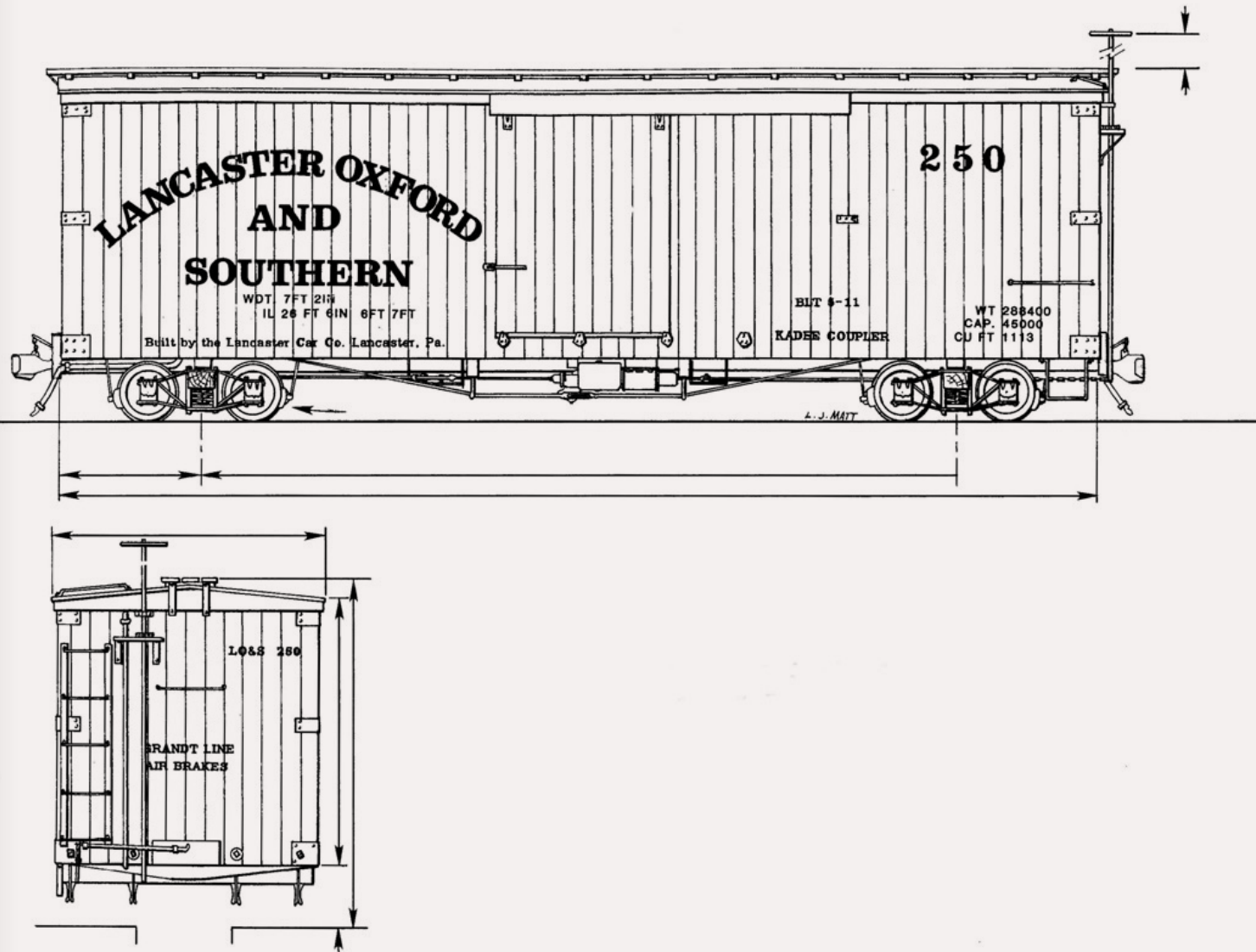


FIGURE 18: The dimensions are open to interpretation and can be filled in as you decide on the style of your car. The car may be made shorter if needed. This is a typical NG box car and could be found anywhere in the US. The operational rolling stock can be made without an opening door but plan on having at least one freight car with interior detail. Non-operational doors can have well detailed door hardware made from cardstock, stripwood and HO rail spikes.

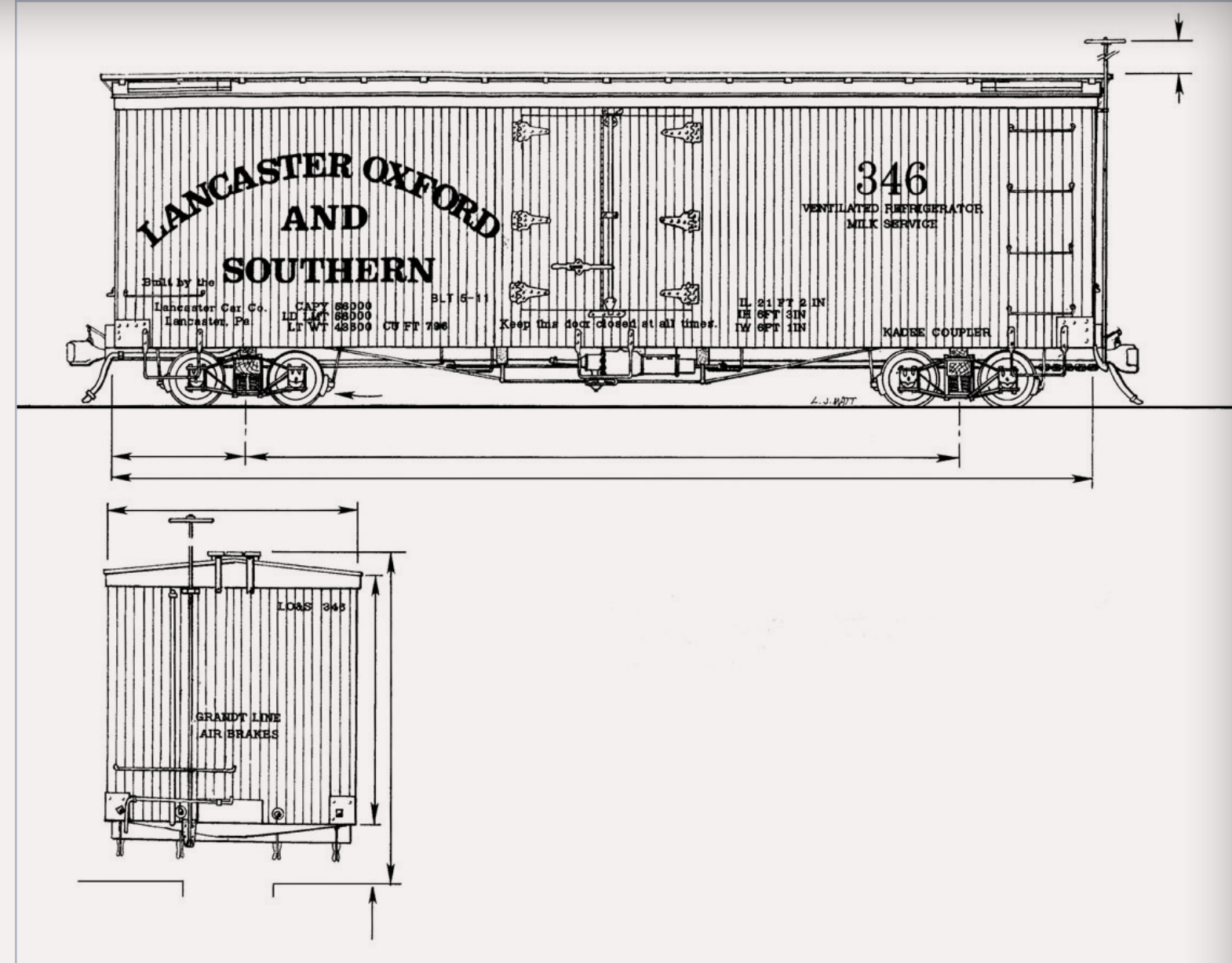


FIGURE 19: This is the type of refrigerator car that would be used for the morning milk run. It is moderate in length, about 25 feet long and can be any width. The car may be made shorter if needed. No icing hatches are located on the roof, as these cars were iced through the main doors. Icing hatches can be added if you prefer. Grandt line makes DRG&W hatches in plastic or you can make your own. You could also change the roof from a peaked roof to a round roof without too much difficulty. It would be very easy to just scribe the side door openings into the car sides, drill the holes for grabirons, add cardstock hinges, wire door detail, and car detail and then paint and letter the sides before gluing to the end blocks.

semi-scale tread. This combination looks and works great for On30 as a truck with an 18" diameter wheel. As long as the car does not exceed 30' in length, the HO trucks and wheelsets look appropriate. Too much car and you need a larger truck. The brake rigging to the trucks is only simulated and cut short so as not to interfere with the truck swivel.

I finished this car in about a week, but I usually work on several cars at the same time, so I don't know how much time it actually took to bash this. There is nothing in this work process that requires a great deal of skill so it may be a good design to use for your first semi-scratchbuilt car. The best thing about the project is the versatility of having a gondola in the revenue fleet.

The elevations of the cars and the exploded views show all the detail needed to build each of the cars. The dimensions are open to interpretation and can be filled in as you go.

The construction technique of the box and refer cars is the same design that was used for the old printed paper sided car kits that were the norm when I was a kid. It is much less expensive and a lot more fun to make your own parts than to buy castings and preformed wire grab irons and steps.

The flat car's stake pockets are simple to make. I threw away several early attempts until I was satisfied with the results. I like to use card stock from 3 x 5 recipe cards whenever a thin strip material is needed such as with the

stake pockets and corner braces, and it takes rivet impressions well.


Scale lumber for the flat car decks was made from scraps of mahogany and cherry veneer salvaged from my neighbor's wood shop scraps. Steps and grab irons are paper staples. The brake staff ratchet and pawl are old watch parts. Just about everything I can find, that looks to be the correct size and configuration, I use. The purchased parts are the ones that are easier to buy than to make, like trucks, couplers, brake wheels, nut-bolt-washer castings etc.

The concept of generic narrow gage car design, particularly in On30, contributes to the ease of scratchbuilding. It only has to be realistic and plausible, not an exact scale copy, to look good and run well. Do a little engineering, or rather, imagineering, and build a string of generic cars to use on your railroad. Remember, you are free to create what you want rather than be limited to exactly what the prototype did, and On30 will serve you well in that regard.

Do some On30 scratchbuilding or kitbashing from HO and S scale cars and parts and send photos of your efforts to the *Model Railroad Hobbyist* magazine as outlined at <http://model-railroad-hobbyist.com/contribute>. Keep it simple and inexpensive but FUN. We look forward to hearing from you and helping you with your show-and-tell!



Article feedback!

CLICK HERE for reader comments on this article ... 



Your Premier Highball Auction Site

UP bids.net

ONLINE AUCTION SOLD

For all of your Railroad needs, whether you are looking to buy or sell, our auction is the best option.

Free Listings
Super Low seller fees
Come check us out!!!!

Advertisement

If you are looking for a great way to display your N, HO and O trains, try grooved ShelfTrax.

Attaches to the wall without brackets.

Learn more at www.shelftrax.com

Advertisement

Read a sponsored side-by-side comparison of concrete segmental bridge kits in HO Scale @ ModelRailroadTips.com, 100% free articles submitted by users.

If your favorite hobby vendor doesn't have an ad in *Model Railroad Hobbyist*, ask them:

"Why aren't you advertising in MRH?"

Charlie Comstock is ...

UP THE CREEK: Geology Lessons

A regular report on the construction of a 1950s-something layout

A clipping from the South Jackson Gazette ...

Scientists Announce Discovery of New Rock Formations



What lurks beneath this scene?

Leading scientists from the small town of Oakhill in the Plaster Peak Mountains claim to have found a hitherto undiscovered type of rock formation. When approached, Dr. P. Wood, the team leader explained,

“Yup, we’re all like real excited about this new formation. Seems like we’ve found some new types of rock strata that appear to be organic in nature unlike the mineral based rocks that are more usual.”

He paused to quaff a bit more from his mug and one of his staff continued.

“Yessiree! And if that wasn’t strange enough these new rocks appear to be sedimentary in origin,

there’s multiple layers to ‘em. And even stranger, the layers have grain and the grain of adjacent layers appears to be about 90 degrees out of alignment with the previous layer.”

The team has concluded that these sedimentary layers prove that the environment around Oakhill must be millions of years old as it would take “an awful long time” to build up each of these layers.

Gaston Aridelyte of the Bear Creek Grill was quick to advance his own theory as to why the layers appear to be laid crossways on each other - it just goes to show that at times in the past there must have been some violently cataclysmic events which changed the axis the world is spinning around.

Horace Fithers stopped by while this reporter was investigating.

“Well,” he said. “Them grey beards are off at it again, millions of years old my foot! Every fool knows that when we first arrived in this universe five years ago Oakhill didn’t even exist! They should know better than to go digging up that ancient earth theory again. If you ask me, it looks a whole lot

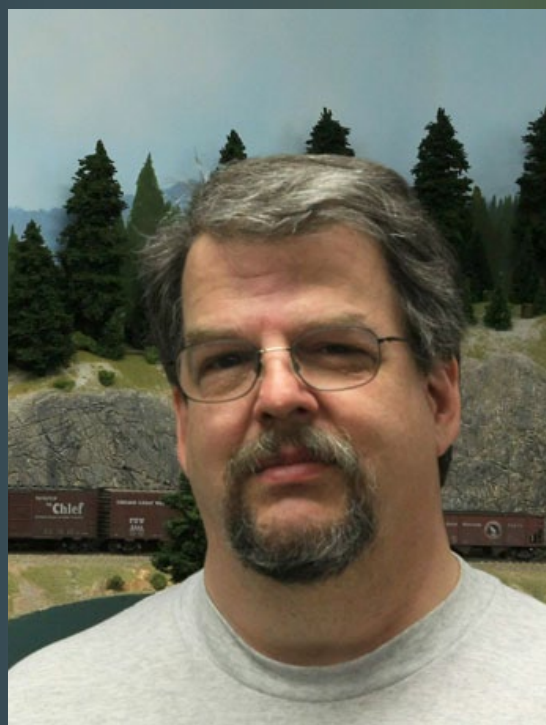
like someone intelligent actually made them rocks or what ever they are what with them differentiated layers being in opposite directions from each other – makes it a whole sight stronger that way!”

This reporter left Oakhill without any reasonable explanations as to where those rocks come from. However, another team member commented off the record because he wasn’t authorized to speak, saying that to tell the truth it seemed like these “new” rocks weren’t all that unusual.

In fact it seemed like they were found all over near the places the railroad went, especially in the flat areas around the towns?

We’ll be eagerly awaiting the next geological updates. ☒

About our layouts columnist



Charlie Comstock is our layouts editor and columnist.

[Click here](#) to learn more about Charlie.

This is the third Up the Creek column. This month I'll be talking about what holds up my basement universe - bench work!

The True Story: What Lurks Beneath the Surface?

We've all seen pretty pictures of model trains rolling through magnificent scenery. Skillful construction (and photography) can leave us thinking the scene we're viewing is real. But is the beauty of our models more than surface deep?

Personally, I prefer to not build my bench work out of stone. It may last forever but it weighs a ton and is really difficult to cut with a table saw (unless you have a diamond-tipped blade).

Instead I've resorted to the more traditional wooden benchwork methods. In

particular in this month's *Up the Creek* column, I'll address how my bench work is attached to the floor and walls.

There are several good ways to build benchwork but I'm only going to touch on the ones that I used myself. First off, let's look at types of benchwork I needed for my Bear Creek and South Jackson.

The peninsula - This will be double-decked with staging on a bottom level (36" height) and major towns and yards on the top (50" - 53" height).

Around the walls bench work - In places like Roberts Creek and Oakhill I need to keep the space below clear because either a lower deck or people will need to pass underneath. In other parts of the layout, legs or braces extending downward are acceptable.

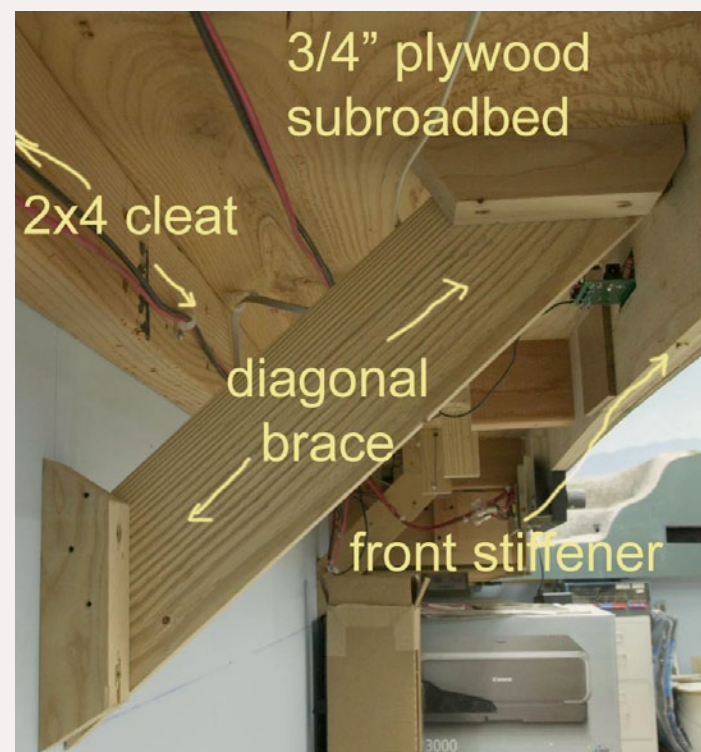


FIGURE 2: Under Mill Bend.

I often build my town areas on sheets of 3/4" plywood. I break up the expanse of flatness by cutting creek or river beds into the plywood. Having the large expanse makes it easier to fine-tune where track goes later.

Between towns - Where there is little more than a ribbon of track winding it's way along a shelf, I use Masonite™ spline subroadbed. I see little point in using large amounts of plywood here - that stuff's expensive!

I build staging areas on plywood also. But what holds up the plywood or spline sub-roadbed? The answer is "that depends".

In Mill Bend I bolted a 2x4 cleat to the wall horizontally using 3" deck screws and screwed the plywood subroadbed to that. (See Figures 2 and 3.) I added a 3" piece of plywood on edge at the aisle side for stiffness and put diagonal braces underneath between the subroadbed's plywood and the wall to keep it from drooping.

Redland on the lower deck (the Land Down Under as I call it) uses benchwork similar to Mill Bend - a horizontal 2x2 bolted to the wall. The Redland plywood is screwed to that and with diagonal leg braces every 4'.

Moving railroad west (right) from Mill Bend, I installed a series of joists cantilevered out from the walls (see Figures 4 and 5 next page). I started each joist by screwing a vertical 2x2" cleat to the wall with 2 or more 3" deck screws

driven into the wall studs. Then I liberally glued and clamped a 3/4" plywood joist to the vertical cleat making sure it was level and it's top was well below the track level (allowing room for the thickness of the spline roadbed). I paid lots of attention to the location of the final scenery contours.

For relatively short joists (<18") I found a 4" high plywood joist worked well. For longer joists I made 'em thicker. To give them a bit of 'leverage,' the vertical cleats should project a couple of inches higher or lower if the finished scenery will hit the wall at the joist's level. The goal is to avoid unsightly scenic bulges.

Oakhill needed to extend up to 4' from the wall in places. It had to be cantilever benchwork construction (no legs running to the floor) because a portion of Redland on the lower deck impinges on the Oakhill space. Deschutes staging is also there, and

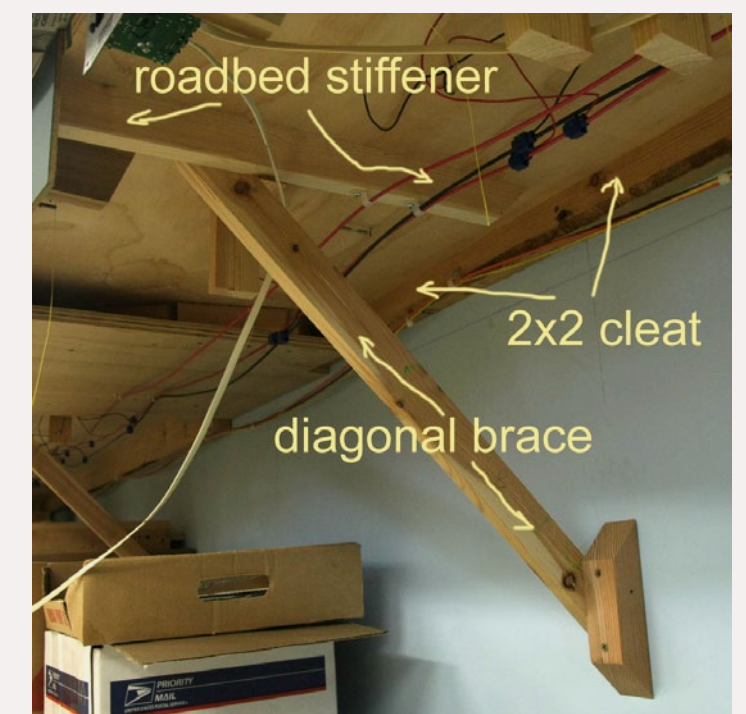


FIGURE 3: Under Redland.



FIGURE 1: 3" deck screws securely fasten cleats to 2x4 wall studs.

that's one of the few places to park an operator's desk for the day when I go to TT&TO operations.

Also, I didn't want to impede the path to the lift up hatch that is used by trainmen whose trains need to use the Oakhill wye

track (see Up the Creek in Issue 2 of MRH - Tectonic Plates). Because these joists were rather long I greatly increased their height where they hit the wall to give better leverage. A 6" tall vertical cleat would have insufficient strength. I also

needed to frame the space needed by the access hatch.

The peninsula has perhaps the most interesting construction of anywhere on the railroad. There are two parts to it – the helix will be supported by an 8x8'

table (Figures 10, 11 and 12 next page). I constructed the table using 4x4 legs topped with well braced 3/4" plywood. The helix will be mounted to the top of this table using threaded 3/8" rods. Other roadbed will be supported by wooden risers.

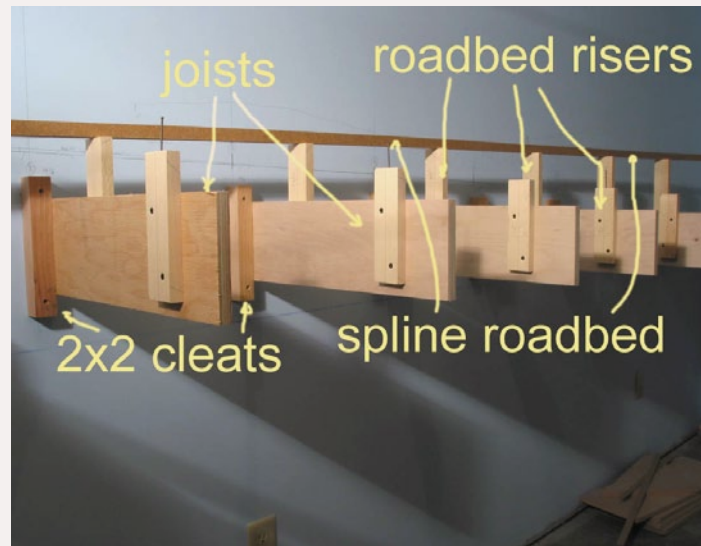


FIGURE 4: Joists and cleats beneath spline roadbed.



FIGURE 6: Cleats in Oakhill are kept low to avoid interference with scenery.



FIGURE 5: More joists and cleats.



FIGURE 7: Long joists below Oakhill with extra long cleats extending downward.

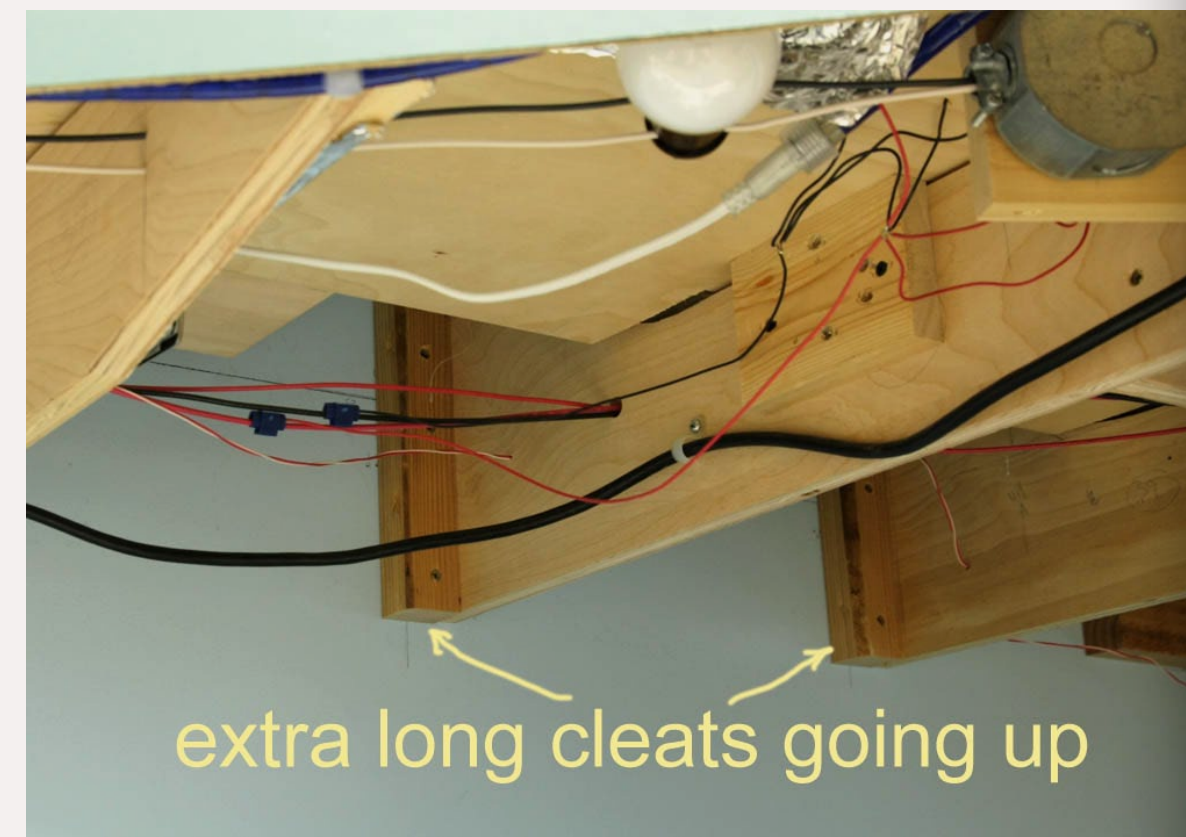


FIGURE 8: Long joists below Oakhill with extra long cleats extending upward.

The rest of the peninsula is about 44' long by 5' wide (see Figures 13-16 this page and next). I didn't want to clutter up the area underneath it with a bunch of legs so I borrowed an idea from Lee Nicholas (www.ucwrr.com). He used engineered joists under the peninsulae of his Utah Colorado Western.

I asked my home builder to put four 24' TGI joists (wooden I-beam) in the train room before putting the skins on the house (they would have been too long to get in through the doors when the house was finished). Three pairs of sturdy 4x4 legs bolted to the floor hold up the TGI joists.

I notched the legs and the engineered beams sit in those notches on shims. If the cement floor heaves I can change out the shims to re-level the peninsula.

I topped the engineered beams with 3/4" plywood flanges, turning them into huge L-girders, and started adding joists and risers.

The area below the peninsula is unencumbered by legs, making it relatively easy to move underneath for wiring or Tortoise™ installation.


To help visualize the construction sequence check out the video clip on the next page. 



FIGURE 9: Upward extending cleats are hidden under this hill.



FIGURE 10: Construction of the helix table under-the-surface bracing.

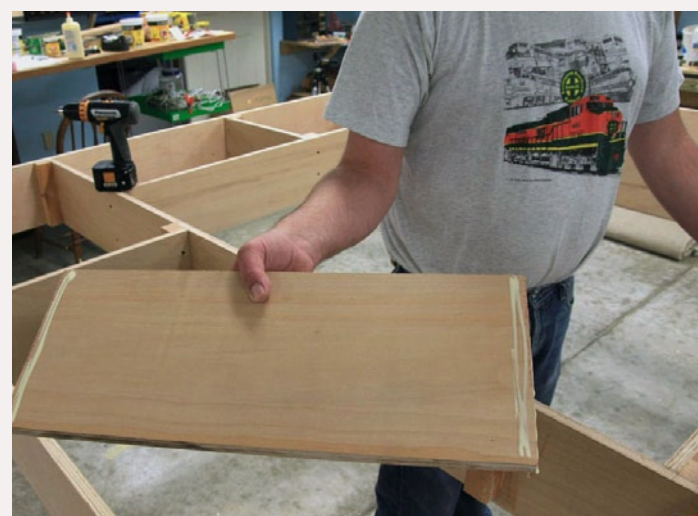


FIGURE 11: All the bracing is glued together for stiffness.



FIGURE 12: gluing the helix table top in place. Later on I'll cut out an area in the middle to provide pop-up access inside the helix.



FIGURE 14: cutting the engineered beams to length. Using the vacuum keeps dust generation to a minimum in the train room.

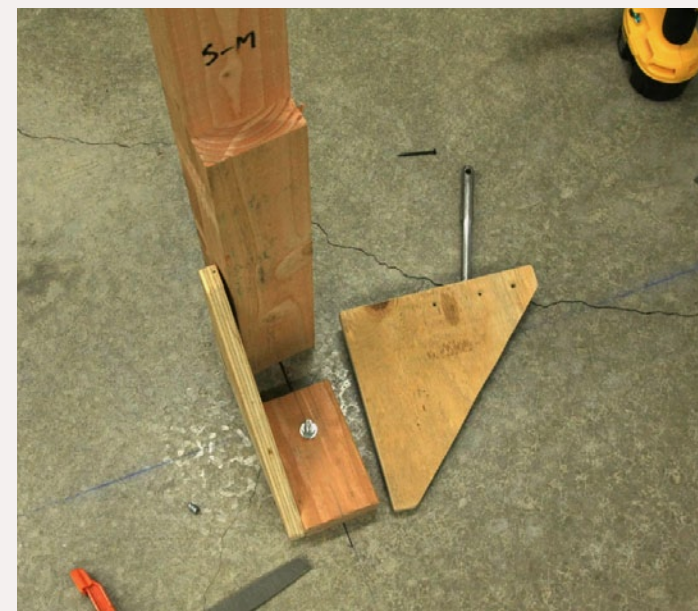


FIGURE 13: Installing a 4x4 leg for the peninsula using a concrete anchor to fasten it to the floor.



FIGURE 15: Shimming the engineered joists to level them.

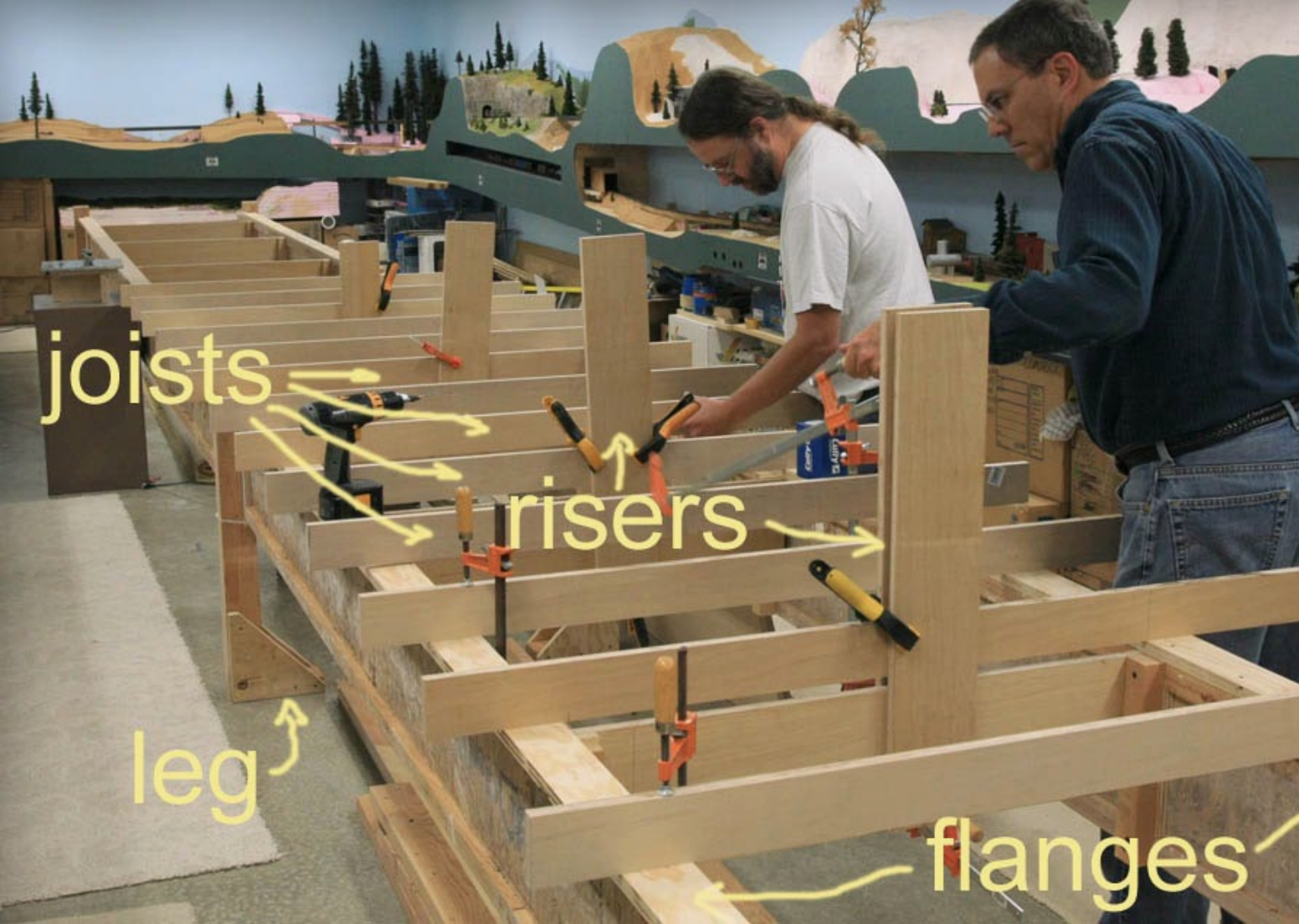


FIGURE 16: Adding flanges, joists and risers to the peninsula.

 **Article feedback!**
[CLICK HERE](#) for reader comments
on this article ... 

COMME-N-TARY: Creating a Realistic Roster for the PRR

Modeling in the hobby's most eNgaging scale

About our N-scale columnist



John Drye is our N scale editor and columnist.

[Click here](#) to learn more about John.

Transition Era Freight Cars in N Scale

The release of new N scale freight cars over the past few years has made it easy to create a roster well-matched to the prototypes of the 1950s. If anything, the plethora of road names and options has made careful selection mandatory in order to not overwhelm the yard crews. After all, none of us have more cars than we can use, right?

Creating a Roster

I set out to create a reasonable and realistic roster of cars for a transition era (mid-50s) PRR layout, representing central Pennsylvania. The idea is to illustrate the freight car red era of railroading, where variety is provided by the different railroads' shades of boxcar red and the many different designs of 40' boxcars. A long train of boxcars can exhibit tremendous variety in color, height, construction material, and design, in addition to roadnames.

One of the Ground Truths in model railroading is that 50 percent of the cars on a Class I railroad are home cars. The rest are foreign roads and private-owner cars.

One way to test this theory is to look at photographic evidence for the period of interest. Fortunately, there are many books and videos available, not just for

the PRR of the 50s, but for pretty much any railroad from the 1940s to the present.

A careful examination, focusing on rolling stock on mainline trains and on active yard tracks, supports the 50 percent ratio. An added benefit is that this examination also sheds some light of the mix of road names on foreign cars. Another Ground Truth, according to long-time followers of the PRR, is that the first car in every Pennsy freight

train is a Northern Pacific boxcar. Well, not exactly, but quite a few cars from the NP and other northwest roads do show up.

Another approach is to look at the size of other railroads in your period of interest. It stands to reason that the largest railroads would have the most cars to send to the PRR (or your own railroad). The largest railroads in North America in 1950 (based on size of freight car fleet) are shown below.

North American Railroads

	Railroad	Fleet Size(*)	Geographical Location
1.	Pennsylvania	190,000	NE
2.	New York Central	140,000	NE
3.	Baltimore & Ohio	89,000	NE
4.	Chesapeake & Ohio	84,000	NE
5.	Santa Fe	80,000	SW
6.	Louisville & Nashville	60,000	MW
7.	Milwaukee	59,000	NW
8.	Norfolk & Western	55,000	SE
9.	Illinois Central	54,000	MW
10.	Southern Pacific	54,000	SW
11.	Union Pacific	50,000	SW
12.	Burlington	47,000	NW
13.	Chicago & Northwestern	44,000	MW

(*) Approximate size: The source for this info and much of the data in this article comes from Official Railway Equipment Registers (ORER). These documents list almost all of the cars used on North American railroads by type and road for a particular year. The NMRA offers one from 1953: <http://jdb.psu.edu/nmra/orer.html> and others can be found on e-bay and at railroadiana shows. They are a fascinating read and useful source.

Size and relative location suggests the number of cars one would see from these railroads. The NYC, B&O, and C&O, which operate in the Northeast with large fleets, each ought to contribute a significant number of cars to the foreign-road roster. So do roads with logical shipping routes, such as the roads in the Northwest that relied on the Pennsy to get merchandise to the east coast. That probably explains all those NP boxcars.

Other large railroads that had connections with the Pennsy such as the N&W, Santa Fe, and L&N contribute a smaller share. Smaller railroads (not listed) with direct connections in Pennsylvania, such as Erie, Reading, Lackawanna and the Lehigh Valley also make a significant contribution to the roster. Small railroads with no direct connection such as the Rio Grande, Central of Georgia and

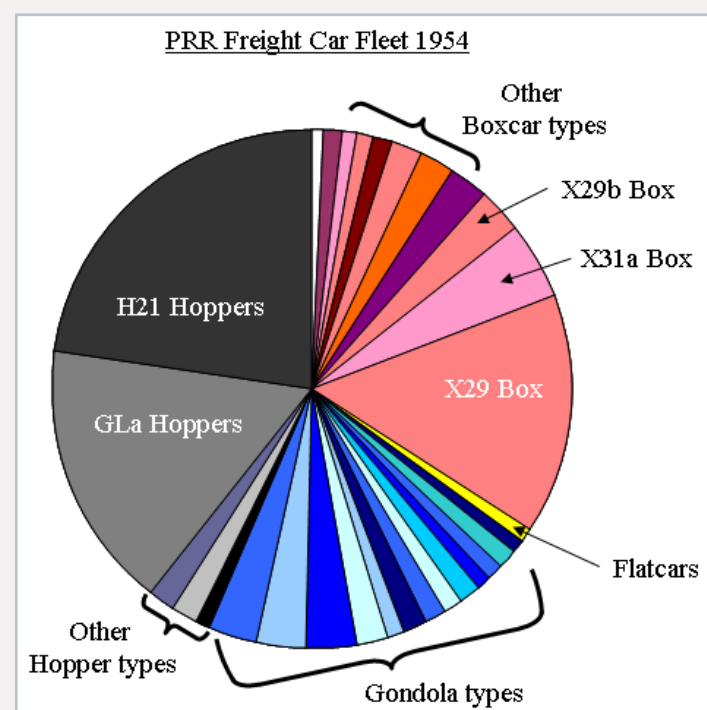


FIGURE 1: PRR Freight car fleet 1954. Source: ORER.

Florida East Coast might contribute just a few cars to the railroad.

In addition to the railroads, private owners operated large fleets of reefers and tank cars. Perishables moved east in solid blocks of orange and yellow cars owned by Pacific Fruit Express and others, and fresh meat traveled from Chicago in a colorful array of meat packer's cars. Fuel, oil and chemicals traveled in an ever-growing fleet of pressurized and un-pressurized tank cars.

In 1954, Pennsy initiated trailers-on-flat cars service called TrucTrain. By 1956, there were dedicated trains running regularly between major cities.

My objective is to create a fleet with a transition era feel—lots of red 40' boxcars, mostly steel but some wood, with a mix of heights and a few unique styles (still 40' and red). Hoppers are a mixture of 2, 3, and 4 bays and gondolas vary from 40 to 75 feet, but most are in the vicinity of 50'. The mix also includes a few flat cars and covered hoppers along with the private owner reefers and tank cars and the beginnings of intermodal service.

So, how do we create some order out of all this information?

The first step is to determine the size of your own fleet. In my case, the railroad needs about 500 freight cars to support the planned trains and industries. My fleet revolves around the Pennsylvania RR, but the same approach can be used to develop a rea-

sonable roster for any road, for either the 20th or 21st century.

Experienced model railroaders tell us that modeling the ordinary rather than the unusual creates a realistic model railroad. However, there is a little room for personal preference. For example, I'd like to include couple of cars from Kansas (KCS, perhaps) to recognize my siblings' birthplace and a few from the RF&P and Southern because both lines (now under different owners) run less than a mile from my house, and are the favorite roads of some of the crew. It's probably ok, since another red boxcar probably won't stand out enough to alarm the prototype police.

The PRR Fleet

We'll start with home road cars. As mentioned, half the roster, or 250 cars, ought to be from the Pennsy.. As we've seen already, the PRR had almost 200,000 cars in the mid 50's. We'll use

the prototypical proportions of that roster to determine the makeup of our model roster.

About a third of the PRR's freight cars were box cars and slightly more than a third open hoppers. About a quarter were gondolas, with a few flat cars, stock cars and covered hoppers. There were also some tank and refrigerator cars, largely for company service (Figure 1).

PRR Boxcars

Our PRR boxcar fleet ought to total about 80 cars (one third of 250). Of these, more than a third (about 30) should be X29s (the PRR labeled boxcar types with an "X" since "B" stood for baggage). X31As and X29Bs (modified X29s) should each be represented with about a dozen cars and the remainder of the boxcar fleet with a variety of less common types.

The PRR built almost 30,000 steel X29 boxcars in the 20s and 30s to replace its fleet of wooden cars,. Many of these lasted until the merger with NYC



FIGURE 2: Red Caboose's model of the ubiquitous X29 showing two different paint schemes.

in 1968. The X29 boxcar might have been the most common single car type in America if the railroad hadn't built so many hoppers. It was designed to comply with the tight clearances common in the east so had an inside height of only 8'6".

Fortunately for the N scale modeler, a great almost-ready-to-run model of this car is readily available.

Red Caboose Hobbies produces this common car in a variety of paint schemes appropriate for the PRR of the 1950s, including the attractive "Merchandise Service" less-than-carload (LCL) scheme. Several variations are available with different brake systems and car ends. Red Caboose has released the car with different numbers, reducing the need to re-number with decals (Figure 2 previous page).

Micro-Trains also produces a ready-to-run car painted as an X29 that is quite close in most respects. The car actually represents the Association of American Railroads (AAR) design from which the X29 was derived. Fine N scale also

produces an easy-to-build X29 resin kit that is an excellent match.

Pennsy's next most common boxcar was the X31A. The class was first built in the 1930s to meet the need for a larger capacity car and was commonly used to transport automobiles. The car had a 10'5" inside height in the center and 10'0" at the sides. This roof design gave rise to the label of "round roof" or "wagon-top" cars. They were built with single or double doors and some had internal devices for special loads.

Fine N scale offers a resin kit in both single door and double door versions. The kit comes with decals and an etched brass roofwalk and brakewheel. The kit is easy even for a beginning modeler and well worth it for the baker's dozen we'll need.

The need to increase the capacity of the X29 was recognized quickly and modifications to the cars were made right up to the end of the railroad. The X29B utilized existing underframes with a new 10'6" interior height body. Almost 4500 such modifications were made in the 40s and 50s.

Class	Type	Model Manufacturer	Number on Roster
X29	40' steel	Red Caboose, M-T, Fine-N-scale (kit)	30
X31A	40' RR	Fine N scale (kit)	13
X29B	rebuilt 40'	M-T, IM	10
various	40' steel	Atlas, DL, IM	15
X32B	50' RR	M-T	2
various	50' steel	IM	4
various	40' wood	Atlas, M-T	6
		TOTAL:	80

FIGURE 3: Summary of the PRR Boxcar Fleet.

There is no perfect match for this car readily available in N scale, but both Micro-Trains and Intermountain produce cars labeled as X29Bs. The doors, ends and roofs on these cars are not a exact match, but the car is the correct height. These good-looking, good-running cars serve as acceptable stand-ins. Ten of these cars fill spots on the roster.

The Pennsy built an amazing variety of almost everything, including more than a dozen more sizable classes (1000 to 3000 cars each) of 40' steel boxcars in the transition era. Collectively, these cars ought to make up another 15 spots on our roster. While not perfect, Atlas, Deluxe Innovations, and Intermountain all make a



FIGURE 4: Atlas rebuilt X26C and IM X29B in one of the colorful "Merchandise Service" schemes illustrate the transition-era variety in boxcar height.



FIGURE 5: Two M-T 50-foot boxcars; the round roof X32B and double door X41.

variety of boxcars that represent AAR and other standard designs. Like the X29Bs, these are reasonable stand-ins and help provide the boxcar variety we are trying to achieve (Figure 4 previous page) .

By the 1950s, the PRR had built a number of 50' and larger boxcars. The X32B was a longer car similar in design to the round roof X31A. Some of these cars had end-loading doors for large loads. When built, these were considered exceptionally large cars.

Micro-Trains makes a model that matches this class almost perfectly. Although few in number on the prototype, our roster will include two of these distinctive cars.

PRR continued to build 50' cars through the 1950s and the end of steam. Intermountain produces a 50' single-door car based on an AAR prototype that serves to represent these classes of cars. The roster includes an-

other four of these fifty-footers (Figure 5 previous page).

Although the PRR began to replace wood single and double-sheathed cars with the X29 in the 20s, wood cars lasted until the end of steam on the railroad. Micro-Trains and Atlas make a variety of wood cars that can represent these holdouts and we'll fill out our fleet with half a dozen of them.

The roster (Figure 3 previous page) .does a pretty good job of portraying the PRR boxcar fleet of the mid-50s, and includes some excellent models of distinctive PRR cars (the X29, X31A and X32B) along with good representation of the variety in the PRR roster.

PRR Hoppers

As one of the nation's leading coal haulers, the Pennsylvania operated a huge fleet of hoppers, more than 70,000 cars, or 40 percent of the PRR fleet in the mid-50s. This accounts for

about 100 of our 250 allocated cars. Almost all of these cars should come from two classes: four-bay H21A and two-bay GLa. The remainder are represented by smaller classes, including a few covered hoppers.

The largest group of PRR hoppers was the H21A class, built from 1911 to 1917. They were originally built as 50-ton capacity cars for coal or coke, and later upgraded with 70-ton trucks and saw-tooth, or paired, hopper doors.

Bowser Manufacturing has offered a variety of quality PRR rolling stock in HO scale for years. When they first offered an N scale version of the H21A, PRR modelers everywhere celebrated. This unique car is a key element of the roster.

The roster will need about 50 of these cars, so it is fortunate that it has been released in groups of 12 individually-numbered cars and a variety of paint schemes ranging from pre-WWII to the merger.

The railroad produced about 30,000 GLa's between 1904 and 1920, both for the PRR itself and for independent

coal companies. Pennsy's first steel hopper car was based on an 1898 design by Pressed Steel Car Co. Our roster includes 40 lettered for the PRR and another 20 for Berwind Coal Company and others (included in the foreign car portion of the roster.).

Like the H21A, the GLa's come from Bowser. The Bowser model includes a lead weight shaped to match the slope sheets. This is a good solution to the problem of unobtrusively adding weight to open-top cars. We'll borrow some of the GLa weights for the H21A's that will run empty on the railroad. Loaded cars replace the weight with BBs or sheet lead, hiding under the coal load (Figure 6).

Before Bowser released the H21A and GLa, Pennsy modelers had to settle for Micro-Train's 33 foot twin-bay hopper. This car is a good model of the less-common H31 class and there is room for 3 or 4 on the roster.

Micro-Trains also makes a composite side version of the H31. While most of the wood sides were replaced in the years after WWII, it is only a slight



FIGURE 6: Bowsers' four-bay H21 and two-bay GLa are the mainstays of the PRR hopper fleet.

Class	Type	Model Manufacturer	Number on Roster
H21A	4 bay	Bowser	50
GLa	2 bay	Bowser	40
H31	2 bay	M-T	4
H31A	2 bay	M-T (composite)	2
H34	PS-2	Atlas	4
		TOTAL:	100

FIGURE 7: Summary of the PRR Hopper Fleet.

stretch to assume one or two made it to the mid-50s as-built. The cars also add a little more variety to the roster.

The Hopper roster (Figure 7 previous page) includes excellent models of the most-common PRR hopper types and includes appropriate numbers of the less-common classes on the mid 50s roster. Nothing says “Coal Railroad” (PRR in this case) better than a long string of loaded hoppers.

The increasing use of concrete in construction led the PRR to produce a variety of covered hopper designs beginning before WWII, eventually leading to production of a variant of the Pullman-Standard PS-2 covered hopper. The early PRR H30 and H32 designs have been available as kits, but are hard to find. Atlas’s PS-2 is close in most respects to the PRR-produced H34A and 3-4 PS-2s will stand-in until a few kits are located (Figure 8).

PRR Gondolas

The freight car graph shows that there was considerable variety in PRR gondola types. PRR gondola classes in the mid-50s ranged in length from 40’ to 65’, with 52’ 6” being the most prevalent length. Some cars were used to transport bulk commodities in containers and some were covered to protect the contents. Many were used to carry steel products from fabricator to customers. Our roster will need a total of 50 PRR gondolas.

The most numerous class were the G31 and variants. These were all 52’6” in length, with fixed or drop ends and steel or wood floors. The PRR acquired a total of almost 10,000 between 1948 and 1950, some built in their own Altoona shops and by American Car and Foundry (ACF). The cars varied somewhat in details.

Micro-Trains makes a 50’ gondola that is at least superficially similar to the G31. It has the correct number of ribs, fish-belly sides and a side-mounted brake-wheel. It is two scale feet too short and off somewhat in other dimensions and details. But it is a nicely detailed and good-looking car, so 35 of these models will serve as a stand-in for this and similar PRR classes (Figure 9).

The PRR GRA and G34 classes were 40’ and 46’ long, respectively. Atlas makes a model of a 42’gondola that is the closest match to these cars. While not particularly accurate in a number of details, the short length does provide some roster variety and 10 of these cars will serve as stand-ins.

Among the longest cars of the transition-era PRR were the 65’6” G26 and modified G26A’s. These were designed to carry long lengths of structural steel and fabrications. Earlier this year, Eastern Seaboard Models announced a model of this class, so 5 spots on the roster are reserved for these long cars .

There is a considerable amount of compromise in our gondola fleet. Scratchbuilding or kitbashing is re-



FIGURE 8: The Athearn 52 foot GSC flat and Atlas PS-2 covered hopper illustrate two of PRR’s less-common cars.



FIGURE 9: MT fish-belly gondola, representative of the PRR 52-foot classes and M-T’s version of the X29 painted in a MoW scheme.

Class	Type	Model Manufacturer	Number on Roster
various	52’6”	M-T	35
various	40’	Atlas	10
G26	65’6”	Eastern Seaboard Models	5
		TOTAL:	50

FIGURE 10: Summary of the PRR Gondola Fleet.

quired to obtain prototypically-accurate models of most PRR classes. However, this roster does portray the variety in lengths and styles of the mid 50-s PRR gondola roster (Figure 10 previous page).

PRR Flat Cars

In 1950, the PRR had only about 2000 flat cars, a pittance compared to the vast fleets of hoppers and boxcars.

However, in 1954, just in time for our era, the PRR introduced what became "Pennsy TrucTrain Service" carrying PRR trailers on modified 50' flatcars. By the end of the decade, PRR was carrying thousands of trailers a year. To meet this demand, in 1955 the PRR purchased 200 new, specially constructed 75' long F39 piggyback cars from Bethlehem Steel.

Micro-Trains, Walthers and Red Caboose all make a generic 50' flatcar which is an acceptable model of the pre-piggyback car. Four such cars, two with loads, represent the F30A class. Open loads provide some of the most interesting elements of model railroad. The examination of prototype photos and videos showed everything from small boats to military cannon barrels. If another couple of these neat cars sneak onto the railroad, that would probably be ok. We can satisfy some of the demand for open loads by modeling the many varieties of steel loads in the gondolas.

Fortunately for early intermodal fans, the modified TrucTrain cars are, or

soon will be available from N scale Kits, who are making the kits formerly offered by Alan Curtis Models.

Our roster will need 12 of the 75' and 4 of the 50' TrucTrain cars, along with 28 trailers. The trailers can come from a variety of sources, including Fine N scale and Sylvan Scale models kits, as well as ready to run metal models. The number of trailers available, both in terms of roadnames and styles provide the variety of a 1950s intermodal train.

Other PRR Cars

In addition to the revenue cars, the roster includes a couple of diesel fuel tank cars from Micro-Trains and some MoW box and flat cars from Red Caboose.

Cabooses

Cabooses (Cabin Cars on the PRR) are not counted on the roster, but are still necessary for transition era freight trains. In the 50s, PRR Cabin Cars were



FIGURE 11: Two cars from PRR's western connections; an Atlas wooden ATSF car and an M-T Northern Pacific boxcar to head up the consist.



Figure 12: An M-T B&O 1929 boxcar and Deluxe-Innovations ERIE ARA car.

		Off-Line Freight Car Fleet							
		Box	Hopper	Gondola	Flat	Reefer	Tank	Stock	Total
Proportion		0.50	0.25	0.20	0.01	0.01	0.01	0.02	1.00
I: Large railroads in PA/NY.	0.25	31	16	13	1	1	1	1	63
II: Medium railroads in PA/NY.	0.20	25	13	10	1	1	1	1	50
III: Other large railroads	0.15	19	2	8	0	0	0	1	30
IIIA: Large Private Fleets	0.15					37			37
IV: End-to-end interchange	0.15	19	1	8	0	0	0	1	29
IVA: Small private fleets	0.05		20				12		32
V: Other railroads.	0.05	6	0	3	0	0	0	0	9
Total:	1.00	100	51	40	2	39	14	4	250

FIGURE 13: Off-Line Freight Car Fleet.

predominately N5 and N5C steel cars. A few wood N6B cars remained on the roster as well, along with a few newer N8 steel cabins. Bowser Manufacturing offers both the N5 and N5C, Cloor Craft makes a kit for the N6B and the N8 is available in brass. Fortunately, 90% of the cabins will be N5s and N5Cs.

Foreign Road Cars

We'll use the factors of size, distance and interchange to develop our foreign road roster. First step is to divide the 100 or so railroads that existed in the 50s into general categories:

- I: Large railroads with significant PRR interchange east of Chicago.
- II: Medium railroads with PRR-interchange in PA or NY.
- III: Other large railroads and large private owner fleets.
- IV: Medium railroads with end-to-end PRR-interchange outside PA or NY, and small private owners.
- V: Other smaller railroads.

Category I includes three railroads: NYC, B&O and C&O.

Category II includes CNJ, D&H, DL&W, ERIE, L&NE, LV, NH, NKP, P&LE, P&WV, RDG, W&LE and WM

Category III includes ATSF, L&N, MILW, N&W, IC, SP, UP, CB&Q and C&NW

plus PFE and other reefer fleets (N&W just misses my cut for Category I—you can create categories that work for your railroad).

Layout Decisions: Williamsport to Altoona

A key element of the layout design process is to periodically review your “givens and druthers” as John Armstrong so eloquently put it. A good time to do that is just before you start the benchwork.

As a result of my own review, the layout I'd planned to build moved about 60 miles to the south, from Williamsport to Altoona. Why?

#1: N scale excels in running long trains through interesting scenery and Horseshoe Curve certainly qualifies.

#2: The layout incorporates the main line from Altoona to Cresson in a sincere and prototypical fashion. MG tower (halfway up the mountain) is represented switch for switch, the layout incorporates the curve itself at 2/3 scale size (making a nice 30" radius sweeping curve), and the layout includes much of the interesting track at Gallitzin.

Trains run slowly in mountainous terrain, increasing the apparent length of the main line. There is lots of variety in the trains that ran over the curve in 1956 (that didn't change). They include reefer blocks, an empty gon train on the way back to Pittsburgh, coal from Berwind, early intermodal, and a nice variety of passenger and general freight trains.

The construction crew (future operators) were unanimously in favor of the change. We are all looking forward to the operational challenge of moving 100 trains a day up and down the hill. ■



FIGURE 14: Rib side, offset side and fish-belly hoppers shown here by M-T's Allegheny Midland and NYC cars, along with Atlas' C&O car (remember that a little creativity is more likely to get past the prototype police if it is subtle).



FIGURE 15: Both Athearn and I-M produce reefers for Santa Fe's large fleet, with 40-foot and 50-foot cars.

Category IV includes CN, CP, GN, NP from the west; ACL, SAL, SOU from the south; and BAR, B&A, B&M, CV, MEC from the east, plus most tank car fleets (UTL, SCL, Gulf Oil and other petroleum companies).

I apologize if this list omits your favorite railroad. Please let me know and I'll add a car to the roster. The ORER again can help with proportions of car types. The allocation of cars to the various types of railroads is a bit of an art, based on the photo and video review.

The table suggests an allocation of cars by railroad and type (Figure 13 page 93). It doesn't go so far as to specify "Six 1943 ARA Boxcars lettered for the Southern Pacific". Rather, it suggests, for example, "we ought to have about ten boxcars each from the NYC, B&O and C&O--31 in total for the three Category I Railroads"; or, "the Category II railroads ought to include a total of 13 hoppers."

Careful observers already will have noted that the percentages do not always add up. It's ok—this is a guide, not an edict.

The reefers are concentrated in Category IIIA: Large Private Fleets. These 37 cars include PFE along with reefers from Santa Fe and Northwest Roads. Less well known than the Santa Fe and SP/UP fleets, GN, CBQ and other roads forwarded a considerable amount of perishable traffic over the Pennsy to the east coast.

The overall percentage of hoppers is reduced because so many of these cars were in captive service and didn't stray far from home rails. That said, an SP hopper appears in the photo reference, far from home, so a spot is saved for a couple of such travelers. There are a total of 12 private owner tank cars and 20 hoppers from private coal companies.

Models

Many of the foreign roster cars can be represented by the more general types used to represent PRR classes. This is especially true of the AAR and other standard boxcar designs (Figures 11 and 12 page 93).

In addition to the PRR class hoppers listed, Atlas, Athearn, M-T and others produce hoppers in a great variety of styles (Figure 14 previous page). A look again at the video reference shows that PRR mineral trains usually included a sprinkling of foreign road cars in the consist.

The Atlas and M-T gondola models and all of the flatcars also can be used to represent foreign road cars.

All of the manufacturers listed, plus Athearn, make great models of the wood and steel reefers of the transition era (Figure 15 previous page). Many of these are also based on specific prototypes.

Intermountain makes a series of stock cars based on Santa Fe prototypes and M-T offers a car lettered for a number of roads (Figure 16).



FIGURE 16: I-M has recently released a Santa Fe SK-T stock car, shown here along with M-T's car, lettered for Burlington.



FIGURE 17: An Atlas 11,000 gallon car and an I-M 8,000 gallon car show the variation in the 1950s tank car fleet.



FIGURE 18: Fox Valley models has released a MILW horizontal rib boxcar shown here coupled to an Athearn B&O 65-foot mill gondola.

Atlas, Intermountain and Micro-Trains each make excellent models of transition-era tanks cars. Fortunately, these represent three different prototypes (Figure 17 previous page). The Atlas model is a pressurized car and the M-T and IM models represent two different sizes of unpressurized cars.

Various manufacturers also make railroad-specific cars. For example, Fine N scale makes an excellent kit of the B&O ribbed boxcar and Fox Valley Model Works has just released a model of the Milwaukee horizontal ribbed cars (Figure 18 previous page).

More and more manufacturers are entering the N scale market with great-looking models. Along with continuing releases from long-time N scale manufacturers, it's becoming harder and harder to keep the yards from filling up.

Your Premier Highball Auction Site

For all of your Railroad needs, whether you are looking to buy or sell, our auction is the best option.

Free Listings • Super Low seller fees
Come check us out!!!!

UP bids.net

ONLINE AUCTION
SOLD

Summary

Well, now I know exactly what additional cars I need to acquire in order to properly represent rolling stock traveling on the Pennsylvania Railroad of 1956. [don't tell anyone—but I think I might need to discard a few cars as well]. This was an interesting and informative exercise. Calculating (or estimating) fleet composition

did produce a few surprises—the large number of gondolas and X31A boxcars needed on the PRR, and the overall rarity of conventional flatcars, as examples.

The roster suggests some models that are good matches for PRR classes and some that are reasonable stand-ins. There are lots of other good-looking, good-running models out there usable for both PRR and other railroads (Figure 19).

Even if you don't model the PRR or even the transition era, you can use this approach to come up with a prototypical roster for your own railroad. ORERs, photos and video are available for almost any era and location. So are excellent books summarizing the freight car rosters of most railroads. They often masquerade as books on guides to paint schemes, but contain a wealth of information on car styles and production. So do the various railroad prototype societies. If you are interested in a specific railroad of the past or present you owe it to yourself to find one and join.

This approach is a pretty good way to accomplish the objective of modeling the ordinary. Your trains are less likely to raise eyebrows among visitors if they look just like the prototype. How far you stray is up to you. After all, it is your railroad.

Article feedback!
CLICK HERE for reader comments on this article ...



FIGURE 19: The next step after organizing and assembling your roster is making the rolling stock look like it works for a living. Details and weathering go a long way towards making that carefully crafted roster look like it belongs on the railroad.

Timesaver Layouts Australia
timesaverlayouts1@bigpond.com

JUMP! into the 21st CENTURY

TURNOUT CONTROL DC / DCC
Super quiet and adjustable Speed and Throw

Click to get more information

SmartSwitch

www.timesaverlayouts.com
www.anemodel.com

PARALLEL LINES: How I Finish Turnouts

Pursuing more reliable and better-looking trackwork

About our
track modeling
columnist



Tim Warris is a long time model railroader and co-founder of Fast Tracks, a trackwork fixtures company.

[Click here](#) to learn more about Tim.

Quick & Easy Turnout Painting Tips for Great Looking Trackwork



FIGURE 1: You don't have to be an expert to get great looking trackwork. With a few simple painting techniques and products, creating realistic trackwork is a snap!

There are as many techniques for finishing trackwork as there are model railroaders, so I won't be so bold as to suggest that the methods I use are the best or only way of painting track. However, over the years I have developed and honed techniques that give me very good results, so I thought I would share them.

We have a large collection of finished turnouts in a variety of scales and sizes that we use as part of our Fast Tracks train show display. I am frequently asked at the shows how I finished the trackwork on the displays. My

approach is actually very simple, requires no artistic skills at all, and uses only a couple of sparingly applied commercial products. Most people are surprised at just how little effort I actually put into finishing trackwork.

I believe I get the good results because of the products I use and how I use them, so this article will focus on how to use these products. Where possible I will suggest substitutions, but to get the kind of results that you will see on my finished trackwork, it is best to invest in the real deal.

Results are always my priority when I build models and trackwork, so I don't

skimp on the products and tools that I use. I find that in the long run it always pays off to not try and save a few bucks by cutting corners on supplies. So rule number 1 is, buy one less engine and invest in the best quality tools and products you can afford for building and finishing your trackwork.

Since most trackwork I paint is built using a mixture of wood and PC board ties, I have developed techniques that effectively disguise a variety of surfaces. These techniques will work well for any type of trackwork, commercial or hand-built.

Allegiances

I'm a Floquil paint man. The older, nasty, "stinks up the house when you spray it" Floquil. The solvent-based paint that sprays on almost dry, dries dead flat and tough and in my opinion, smells heavenly. I have tried other products, but have always come back to Floquil. Other modelers get great results with other materials, but I am writing this article about how I paint turnouts, and I use Floquil.

Painting turnouts works best using an airbrush. A good quality airbrush (I use a Badger 350 dual-action) allows very precise control of the paint flow. It is one of the most valuable tools you

can invest in. Having an airbrush, and also works well) allows you to remove only the paint on the rail head, unlike a paper towel which has a nasty habit of wiping paint from the ties and getting caught on everything.

Let the base coat dry thoroughly.

Using the Rail Brown mixed with some light grey, I like to paint a few ties to create a bit of a random coloration. I make a point of painting one or two PC board ties as well, as highlighting a couple of these ties actually helps hide them.

Next, I apply the ballast. My preferred product is Woodland Scenics Fine Grey. The color is perfect, and the size of the fine ballast works well for most scales.

I don't like the larger ballast sizes. It seems a bit big for my tastes, even though it probably scales out correctly. I have found that not everything on a model should be precisely scaled to look right.

I spread the ballast with a brush, carefully working it out of the flangeways and switch points. I remove as much as possible along the edge of the rails where it wants to gather. I also rub along the top of the ties with my fingers to remove the ballast. Even though it is very common for ballast to

gather on ties on the prototype, it just doesn't seem to look right on a model.

Using a spray bottle, I heavily soak all the ballast with water; this allows the glue to flow properly. It's

often recommended to add some dishwashing soap to the water as a wetting agent, but I don't bother. I find it isn't necessary and just causes a lot of foam in the water.

Once the ballast is soaked with a fine mist, the glue will flow fine. Without pre-wetting the ballast, it is difficult to get the glue to flow well. Soak it heavily. It will pay off.

Next, I apply Woodland Scenics Scenic Cement. This is a good example of the importance of spending a bit more for a good commercial product. In the past I would just use diluted white glue, but

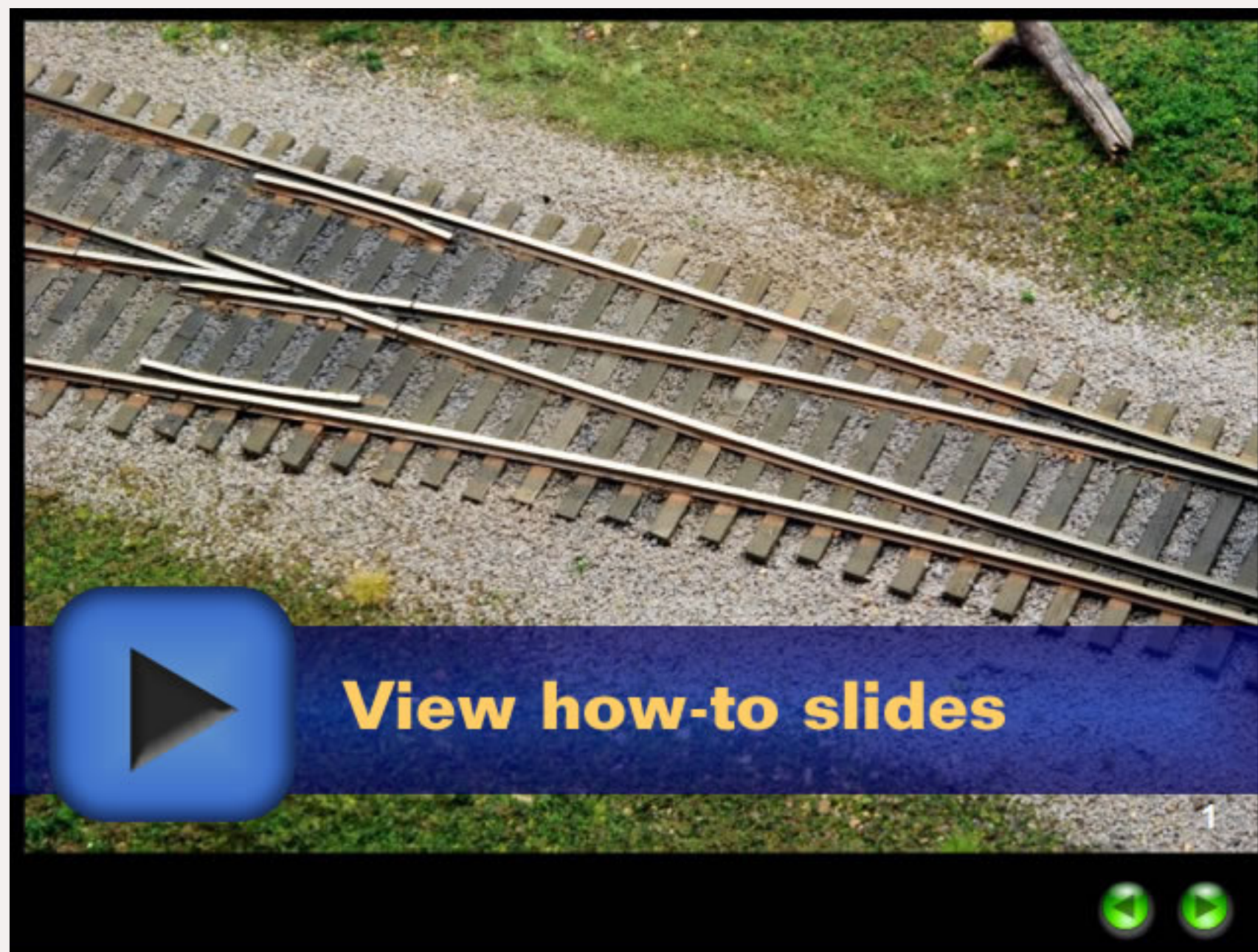
found the results to be inconsistent. Sometimes I got a good bond, but other times the glue would form a shell on the surface with loose ballast underneath. The first time I vacuumed the layout, off came the ballast! Occasionally the glue would discolor the ballast (ok, that was my fault for using yellow carpenters glue). But the biggest problem with mixing my own ballast glue was getting the mixture too strong, resulting in the points being permanently glued to the ties!

For a few bucks a bottle, the pre-mixed Woodland Scenics cement is a mixture that flows well and gives consistent results every time. So buy one less train car and spend the money on glue for your ballast.

I thoroughly soak the ballast using an old carpenters glue bottle to apply the glue solution. This allows me to apply a lot quickly. I apply the glue with the tip of the glue bottle almost touching the surface of the ballast, being careful to be gentle so as not to move the ballast around.

Now let it dry. Not just a few hours or even overnight, but for at least 24 hours. A few days are even better. Resist the urge to touch it. Leave it be. Don't even look at it if you can help yourself. I have found I have caused more messes by fussing about

Step by Step Slide Show



with the ballast before it was properly cured. Most importantly, don't try to move the switch points! All that glue all over the place will look like a disaster, but it will be fine once it cures. Trust me.

After the glue has dried I like to scrape off any ballast that made its way onto the side of the rails. This looks very unnatural and should be removed. I find a small stick of wood works well for this. Don't worry about scratching the paint; we will fix that up later. I also rub the top of the ties to remove any ballast that ended up there.

Freeing stuck points is easy after the glue has thoroughly dried. They usually will just snap free. Push on the rails, not the throwbar, to break the bond. Pushing on the throwbar can damage the turnout if the glue

bond is strong. This is another reason to use Woodland Scenics cement; it rarely forms a strong enough bond to permanently stick the points.

If any grains of ballast are fouling the throwbar, scrape them out with a sharp knife. Look for grains of ballast between the switch points and the stock rail being sure that the points close up tightly. Exercise the points back and forth vigorously to free them up.

Next, I apply a wash of black leather dye diluted with isopropyl alcohol. I make two different strengths, a light and a dark. I have no idea what the ratio actually is; I just make one lighter than the other. I test the solutions on some scrap wood until I get the colors I want.

On prototype trackwork the area between the rails is typically dirtier



FIGURE 2: Areas around the frog and switch points are stained darker than the rest of the turnout to simulate the look of prototype track.

Storing Floquil Paint



FIGURE 3: I make a habit of removing excess paint from around the neck of the paint jars before storing them. This will prevent paint from building up on the neck, and makes reopening the jar much easier. I also keep a set of pliers nearby to help coax tight lids from the jars.

The most effective way to keep Floquil paint (or any paint for that matter) from drying out in the jar is to store them upside down. I have paint stored this way that is over 15 years old and is as fresh now as the day I bought it. Keeping the jars upside-down forms a perfect seal, preventing the paint from drying out. It also has the added feature of allowing you to see the colors easily.



FIGURE 4: I made a special drawer in my workbench just for paints. All stored upside down.

than the outside. This is an easy detail to add, and is very effective. Using the lighter leather dye solution, I brush the area between the rails of all the trackwork. This can sometimes take a couple applications if the solution is very mild. It is best to use two or more applications because if the result is too dark, there is no undoing it.

Once this has dried, I use the stronger solution around the switch and frog point. These areas on prototype turnouts are always noticeably grimy and this is what we are simulating. Again, a couple applications may be necessary.

Let this dry. Since it is alcohol based, it will dry quickly – usually 30 minutes or less. Occasionally the alcohol solution will cause the glue to bond the points

to the ties a bit. If this happens I simply work them free again once it is completely dry.

Now for the finale. The killer app. The one thing that makes it all look fantastic. Use a Floquil Paint Pen – Rust color. These things are perfect for painting rail. They are like a big permanent marker, but are full of Floquil Paint awesomeness.

Shake it up well and press down the tip down on a scrap piece of wood until the paint flows. Then simply drag it along the sides of the rails to apply a nice coat of rust.

I let any stray bits of ballast just mix up in the paint. It adds a nice texture. I also use the paint pen to simulate tie plates on handlaid track where there





FIGURE 5: Using a Floquil Paint Pen, rust color, on the sides of the rails is quick and very easy to do with this product. The results are dramatic and add a very realistic touch to any finished trackwork.



FIGURE 6: No tieplates? It is simple to create the illusion of tie plates using a Floquil Paint Pen, simply drag the pen along the rail and slightly onto the top of the ties. From a viewing distance the effect is very convincing, and very easy!

are none. It is very effective in recreating the familiar look of rust stained ties and ballast caused by rusty tie plates. Remove any paint on the top of the rail using some lacquer thinner soaked wood scraps as before.

That's it! The turnout is painted. Stand back and enjoy. Resist the urge to hang it on the wall as art...

 **Article feedback!**
[CLICK HERE](#) for reader comments
on this article ... 

 **www.CVMW.COM**
CENTRAL VALLEY MODEL WORKS
FOR DETAIL AND REALISM IN
H-0 scale TRACK AND BRIDGES
THERE IS NO NEED TO LOOK ANY FURTHER!

PHONE: 805-489-8586 | EMAIL: info@cvmw.com
CVMW: 1203 PIKE LANE, OCEANO, CA 93445

NEW MEDIA MODELER: Goodbye newbie status

Model Railroading in the Internet Age

About our
new media modeling
columnist



Ryan Andersen is our resident new-media technology expert.

[Click here](#) to learn more about Ryan.

The quest for a standard definition of Model Railroading experience levels

I was recently reminded by a listener of *The Model Railcast Show* that I am not a newby (or newbie) anymore. Somewhere between 12 months ago and today I must have crossed over some imaginary line to become an “experienced” model railroader. This listener did not give any hints as to what my new experience level would now be called. So off to the web to find out!

First Stop: Google

I typed “model railroad skill levels” into the search box and put Google’s gears in motion. The first page of results did not return much information regarding specific skill levels for model railroaders. However the 9th entry was a link to WikiBooks and a section on Model Railroading that referred to the “Artisan Master Award”.

The Wikibook entry explained that Model Railroading Skill Level 2 was added as a component of the Artisan Master Award in 1967. The Adventist Youth Honors hands out this award – this is the first I’d ever heard of it.

Now this article has nothing to do with religion, unless you’re religious about Model Railroading!

The article on Wikibooks is pretty neat. It lists 8 questions that one must answer correctly in detail in order to attain the Model Railroad

Honor, Skill Level 2. See how many you can get right (see sidebar next page)?

This is quite a list!

Bing.com Search

The Google search did not yield what I expected to find: something from the NMRA about Model Railroad Skill Levels. Next, I headed off to Microsoft’s brand new **Bing.com** search (actually their live.com search engine renamed, with a few new features).

Microsoft plans to launch a multi-million dollar ad campaign to introduce Bing to the world, in hopes of stealing some of Google’s traffic. Microsoft claims that Bing will give you more precise results without overloading you with statistics. So I typed the same “model railroad skill levels” into the search box.

Well – I have to say Microsoft might be on the something, because the first 10 results were far more relevant than Google’s! Bing’s very first entry

The screenshot shows a Wikibooks page for "Model Railroad" under the "Arts and Crafts" category. The page is part of the "Adventist Youth Honors Answer Book". The main content area includes a table with "Arts and Crafts" and "Skill Level 2" as columns, and "Year of Introduction: 1967" as a row. Below the table, there is a section titled "1. Give the history and development of model railroading." followed by "Practical Beginnings" and "On the Right Track". The "Practical Beginnings" section discusses the development of model railroading, mentioning that it was first developed to reduce the time and effort required to move raw materials or people over short distances. The "On the Right Track" section discusses the first toy trains of the 1840s, which were produced by filling a metallic model with water and placing it on a heating surface.

FIGURE 1: From a Google search the author found this very interesting Adventist Youth site defining their Model Railroading Artisan Master award.

started with the NMRA. :o) The other results were more accurate also, and I noted that the Adventist Youth Honors entry was the 4th results listed.

Wait-a-minute! Bing's NMRA entry pointed to the NMRA home page, nothing about Skill Level there. Hmm. Next, I used the search box on the NMRA home page, and received results from Google (talk about going in circles).

At this point, I am getting annoyed. I just want to know what the "official" skills level are!

Okay, here we go. There's a reference to (<http://www.nmra.org/education/achievement/reqs.html>) that spells out some information on the "Achievement Program" and its requirements. Along the right side of the same web page is a list of links, all related to the NMRA Achievement Program.

So I read through this documentation. I must say it seems more complicated than it needs to be – more things the NMRA is still doing seems to be that way to this "ex-newbie", unfortunately.

Level 2 Test

1. Describe the history and development of model railroading.
2. Explain the differences between how steam, diesel, and electric locomotives operate.
3. List the name, scale, and track gauge for at least 4 model railroad scales.
4. Describe the name and shape of at least 8 track plan arrangements.
5. List at least 6 points to check for the maintenance of a model railroading layout.
6. Explain the use of:
 - 5 types of freight cars.
 - 3 types of passenger cars.
 - 3 types of steam loco wheel arrangements.
 - 2 types of grade crossing devices.
 - 2 types of railroad signals.
7. Construct a portion of a model railroad layout:
 - Assist in assembling the framework.
 - Install a section of track.
 - Install a section of ballast.
 - Install at least one turnout, including the wiring.
 - Assist in making scenery, such as trees, rocks, mountains, or grass.
 - Make one model railroading structure or building.
 - Assist in wiring to supply electrical power to the track.
8. Successfully operate a model railroad train on the layout you have assisted with. ■

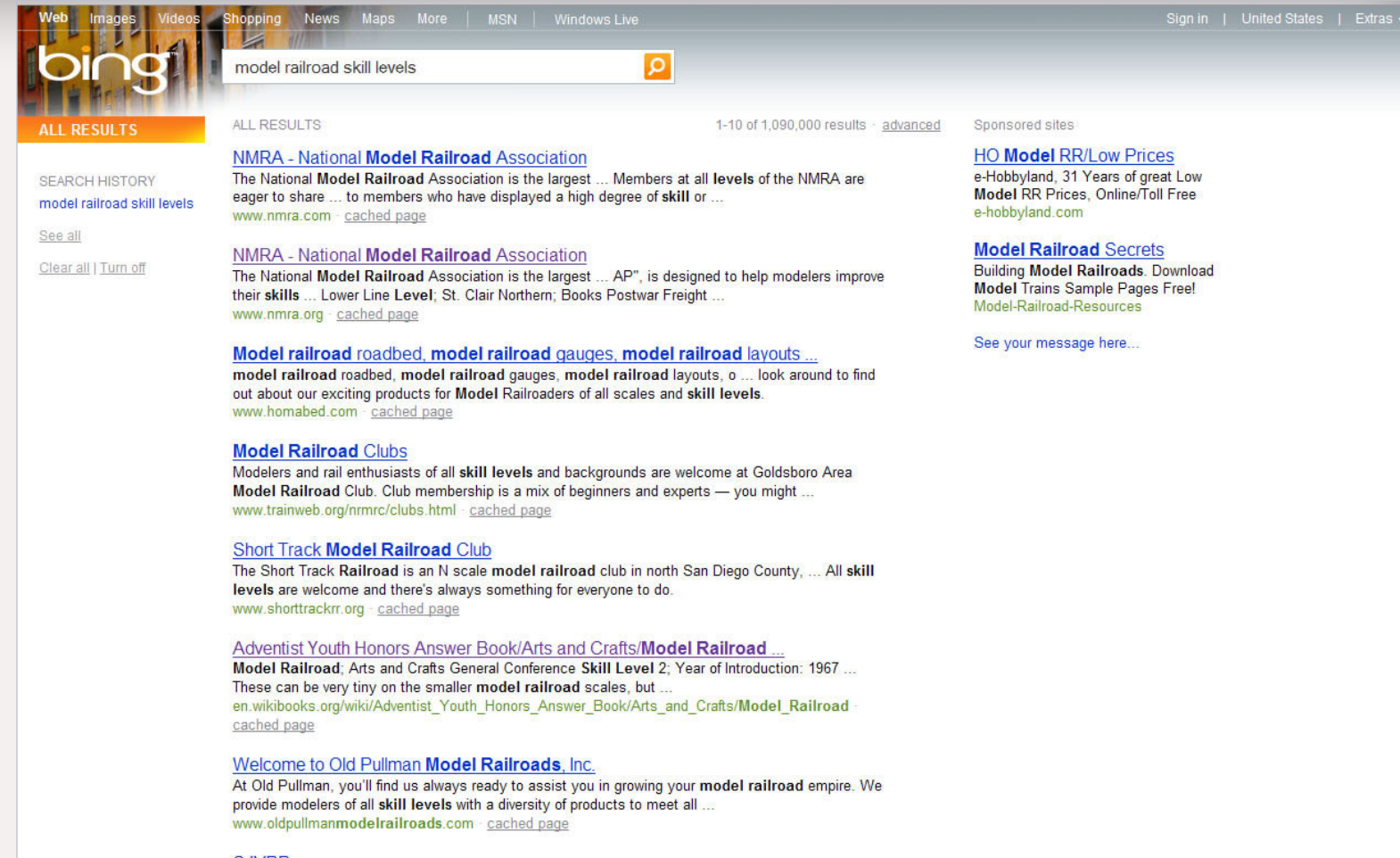


FIGURE 2: A Bing.com search returned far more relevant results than Google.

How to Define Your Skill Level?

In the end, I could not find a clear definition that allowed me to assign myself a "Model Railroader skill level." Maybe just using "years in the hobby" as a guide to skill level works – this means I'm now a second year Model Railroader.

But there's so much to model railroading, a simple "year" designation doesn't seem to be enough without having some formal classes, training, steps of achievement or other way to measure your actual progress.

I wonder if we, as a hobby, can find some middle ground between the simplistic "year" designation and the NMRA's somewhat arcane Achievement Program.

To be fair to the NMRA, I may not have the experience needed to fully understand why the NMRA's Achievement Program needs to be so complicated, but I have a feeling one reason might be due to the broad-spectrum detailed skills needed to fully do our hobby.

In the end, we Model Railroad because we enjoy it, and that's all that matters, really. Meanwhile, the internet search engine wars continue.

Until next time guys! You can catch me and the rest of the Railcasters on weekly the Model Railcast Show.



Advertiser Index	Page
Accu-Lites	7
BLMA (1)	2
BLMA (2)	23
Canyon Creek Scenics	50
Central Valley	104
CF Shops	24
Craftsman Structure Show 2009	17
Dallas Model Works	3
Division Point	16
Fast Tracks	4
Layout Vision	91
Litchfield Station	14
Micro-Mark	12
Model Railcast Show	107
Model Railroad Hobbyist (1)	25
Model Railroad Hobbyist (2)	55
Model Railroad Tips (1)	15
Model Railroad Tips (2)	86
Model Trains Video	119
Model Trains Weathered	22
MRH Reader Survey	17
New York Railway Supply	54
NMRA Division 3 MCR	15
Pulsar Professional FX	8
QSI Solutions (Tony's Trains)	10
Rapido Trains	9
Scotty Mason Show	13
ShelfTrax	86
Timesaver Layouts	100
UPBids.net (1)	12
UPBids.net (2)	15
UPBids.net (3)	86
UPBids.net (4)	100
Vernonia Northern	15



The Model Railcast Show

Keeping you on the RIGHT TRACK!

 **Click here to learn more ...**

The Jack Burgess Interview: The Yosemite Valley Railroad

– by *Charlie Comstock*

Photos by the author

When I had the opportunity to interview Jack Burgess for Model Railroad Hobbyist magazine I jumped at the chance. Walking through the double doors from the real world into August 1939 at El Portal, entrance to Yosemite National Park, it seemed I already knew the area well, so often has his YVRR been featured in print and video. Jack is both well spoken and knowledgeable.

He is a serious prototype modeler. If it wasn't on the YVRR in August 1939, you won't find it on his model. I felt a bit of trepidation meeting him

because my own railroad is largely freelanced. Not a problem. Jack ever the gentleman made me feel welcome.

His layout snakes it way along the Merced River canyon in the Sierra Nevada mountains. Straight track is hard to find once you start up in the hills. Grades are moderate except for a logging incline railroad that the word 'steep' fails to describe.

I asked Jack about a number of the scenes on his railroad. His amazing knowledge of details reveals the depth of his research.

Charlie: Thank you very much for having me today, Jack.

Jack: Thank you.

Charlie: Tell me about this building? (Figure 1.)

Jack: This is a model of the El Portal station. This was built as a contest model. I've done that for years as a way to motivate me to get models finished and also as a way to ensure I keep building things to pretty high standards.

The roof was left incomplete because it has a complete interior. It's all scratchbuilt out of styrene. One of the challenges on this model was the roof; in order to have a very thin roof and not have it warp I used sheet brass as the main substrate for the

roof. I covered that with typing paper that was adhered with spray adhesive and once that was done I could add Campbell shingles. This model took 124 out of a possible 125 points at a Pacific Coast Region NMRA contest and it came out fairly well (that's an understatement! - ed.).

Charlie: What about this one? (Figure 2).

Jack: This is a model of the Standard Oil office that was in El Portal. The building still exists today. It's now owned by the National Park Service. This building has a 'hip' roof. One problem I've had in the past with this type of roof is that it eventually warps. What I do nowadays is build the roof, all four sides, and bond them to the ceiling so I have one huge piece of material. Then I cut a hole in the

ceiling and turn the roof assembly upside down and fill it full of plaster. Once that cures it locks all four sides

of the hip roof to the ceiling and makes a very sturdy roof that will not warp at all in the future.



FIGURE 2: The Standard Oil Co. office in El Portal.



FIGURE 1: The depot at El Portal - the roof has a hole so visitors can enjoy the fully detailed interior .



FIGURE 3: Jim Law's house at Incline.

Charlie: Didn't you meet the fellow who lived in this house located at the base of the incline railway (Figure 3 previous page)?

Jack: I met Jim Law back in the early 70's and he had been the foreman on the logging incline.

When the logging company went out of business in 1942 he bought this house from them for a dollar and lived in it into his 90s. We used to go up and see him 2 or 3 times a year. During the summers we would sit out in his backyard and he would pull out photos and tell stories and answer questions and so forth.

This building is also scratchbuilt as all of the models on the layout are.

Charlie: Is this styrene or is it wood? It looks like wood.

Jack: Actually it's both. This one started out as a styrene shell, then I used individual stripwood, pre-stained, and added to the styrene shell using CA. The windows are all styrene.

Charlie: What did you use for those window screens?

Jack: The screens are computer glare screen. I found it in an electronics surplus store maybe 20 years ago ... they're photo-etched stainless steel, very thin screens and they make a very nice effect.

Charlie: Here's Jim Law standing in front of... what is this building (Figure 4)?

Jack: This is the telephone shack at the bottom of the incline. This is scratch built out of wood, something I normally don't do, and has a full



FIGURE 5: A prototype photo of the Incline telephone shack. Jim Law is standing on the left. Photo courtesy of Jack Burgess.

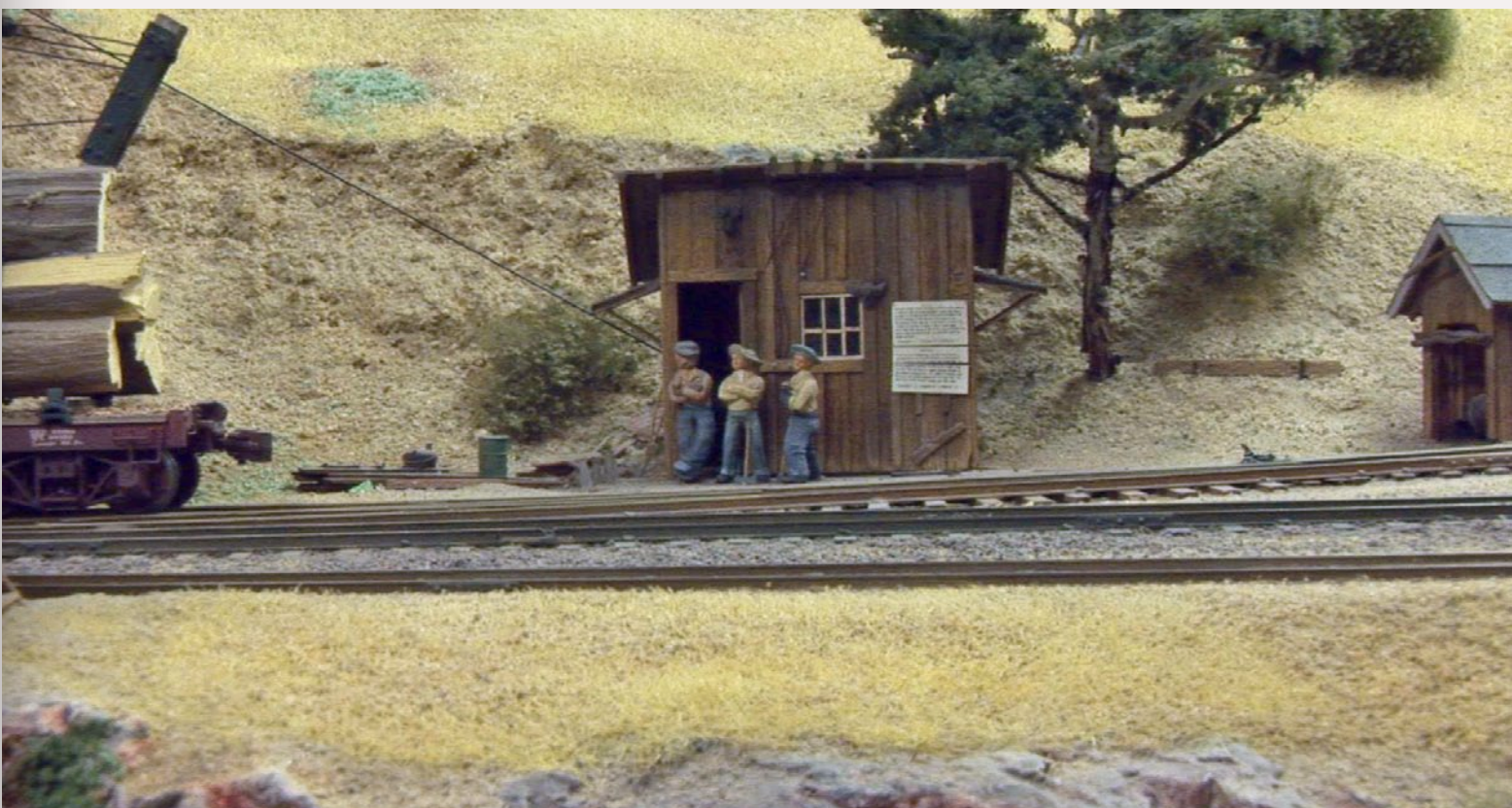
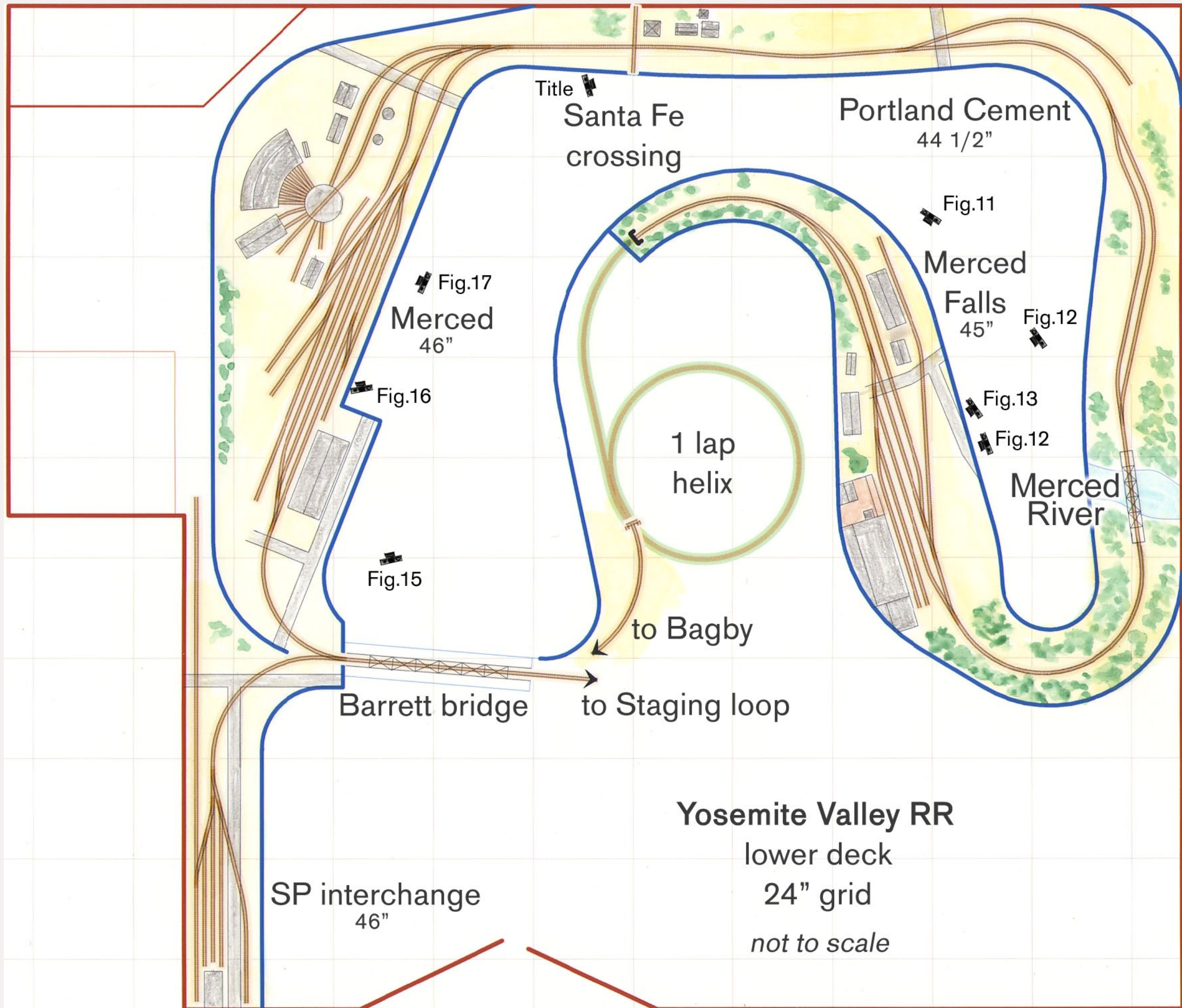
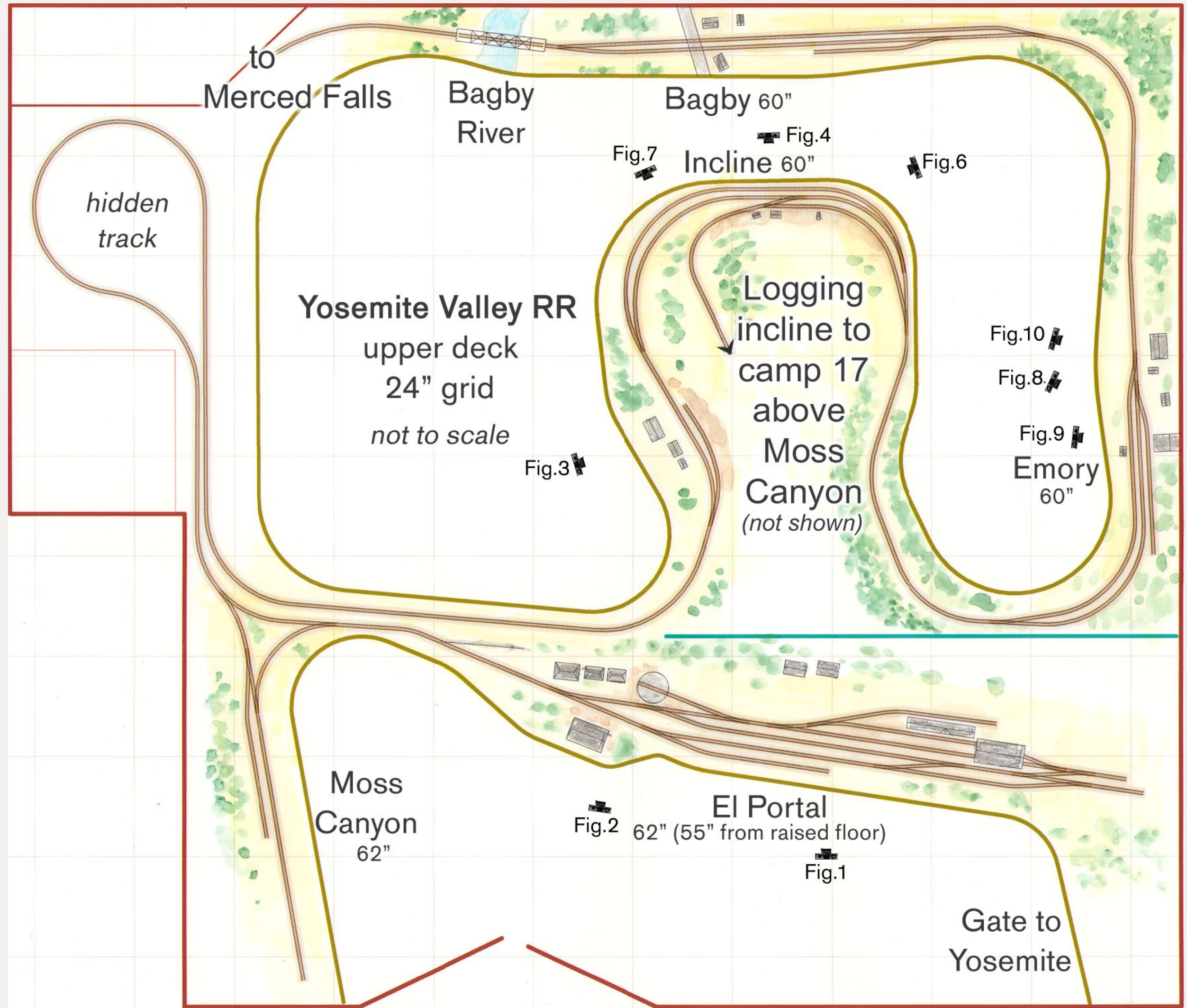


FIGURE 4: The telephone shack at the bottom of the incline lumber railroad. Jack modeled this building from a prototype photo he had.



FIGURE 6: The tank at Incline held Bunker C for the Shays at the top of the logging incline





to
Merced Falls

Bagby
River

Bagby 60"

Fig.7
Incline 60"

Fig.6

hidden
track

Yosemite Valley RR
upper deck
24" grid
not to scale

Fig.3

Logging
incline to
camp 17
above
Moss
Canyon
(not shown)

Fig.10

Fig.8

Fig.9
Emory
60"

Moss
Canyon
62"

Fig.2
El Portal
62" (55" from raised floor)

Fig.1

Gate to
Yosemite

interior and all details of the prototype. Notice the broken batten on the right hand side and the redtail hawk hung up by the window. The sign is actually readable under a 30x microscope.

Jack: This is a prototype photo of the telephone shack taken in 1926. Jim Law is the fellow on the left (Figure 5).

Charlie: What's the tank [on the hill behind the flat cars] doing there (Figure 6)?

Jack: This is at Incline again. The tank is for Bunker C [fuel oil]. The logging company used Shays up in the woods that were fired with Bunker C and in order to get fuel to them the YV would bring in a tank car and unload the oil into the tank.

When they needed fuel for the Shays they would bring down a little 3,000 gallon tank car specifically designed

for the incline [dome on the high end], spot it here, fill it full of oil, and then take it up the incline and into the woods where they could then refuel the Shays.

Charlie: The incline operated by lowering cars by wire with a winch (Figure 7)?

Jack: Right.

Charlie: What was the grade on the prototype?

Jack: The prototype got up to near a 78% grade near the top.

Charlie: That means it's close to 40 degrees from horizontal?

Jack: Yeah, if you've ever ridden one of the old roller-coasters, the wood type roller coasters, the first drop is about what this incline was. Steep!

Charlie: We're looking at part of the Portland Cement Co in Emory. What went on here (Figure 8)?

Jack: As you mentioned this is Yosemite Portland Cement. They had a

quarry served by an incline [railroad]. This incline was only about 2,000 feet long, still very steep though.

They mined limestone and had a little standard gage railroad, diesel powered



FIGURE 8: The Portland Cement Co complex at Emory. An incline railroad, shorter and not as steep as the one at Incline, brought crushed limestone downhill to the bunker.



FIGURE 7: The logging incline in action. The prototype was extremely steep, reaching a 78 percent grade near the top.



FIGURE 9: Close-up of the rock car loading facility at Emory.

at the top, that took the limestone from a quarry to a crusher. They crushed it, brought it down the incline and stored it in this 250-ton bunker. The cars they used were ex-Great Northern [ore] cars used on the Great Lakes. On the YV they were called rock cars. I've never figured out exactly why but I expect it was because when first purchased they were used to haul rock to a construction site where they were building a dam. But they were always called rock cars on the YV.

They would be loaded up with limestone and then transported down to Merced where there was a plant that took the crushed limestone and turned it into Yosemite brand Portland cement.

Charlie: How did you model the cars here (Figure 9)?

Jack: These are all Westerfield kits, they're all resin. Al Westerfield had already come out with a sister car to these little 22' cars. He'd already done the trucks and so I worked with him, provided some plans, photos and so forth. He then produced the kits for these little rock cars.

Charlie: What are you using for the loads in the cars?

Jack: The loads are Woodland Scenics ballast. I talked to a geologist who works for the National Park Service in order to get the right color. He told me that it was a light gray limestone that was brought out of this particular quarry. The loads are all fixed. I don't transfer the loads themselves, I just move the cars back and forth between operating sessions.



FIGURE 11: Unloaded log cars complete with a layer of tree grunge on them.

Charlie: The bunker holding the limestone here at the bottom of the incline; how did you get plans for it?

Jack: Actually I drew it up using a couple of photos using the little rock cars as a general scale and built it out of wood. Many years later we got permission to go into this area, it's across the river from Hwy 140, and I found the footings for the bunker, measured them and it turned out I was about 10% off on my model which isn't too bad.

Charlie: The footings were concrete?

Jack: Correct, the footings were still there. The same thing for the sign on the hillside. When they abandoned this quarry they simply took a chain saw and cut off the legs of the billboard. We went up, measured the distance between the legs and from that were able to generate the

proportions for the billboard and make a good replica of it.

Charlie: You have some really realistic rocks. Did you cast or carve them (Figure 10)?

Jack: These are all cast. I actually went up to the YV and tried to find some rocks that in HO scale were representative but they weren't working out. What I finally did was I knew a fellow who was in charge of a [highway construction materials] quarry here in town and I called him up and asked him if I could borrow a few rocks. So I went up there to the quarry, made rubber molds and cast these myself out of Hydrocal [plaster].

Sierra rocks are relatively new as compared to say, the Rocky mountains which are very old. [Putting] a lot of stains on the rock doesn't work for me to represent typical rocks of the Sierras.



FIGURE 10: An example of Jack's great rock work at Emory.

I put the castings in place, then paint all of the plaster with tan latex interior [house] paint. That seals up the plaster and when that's dry I stain the rocks with acrylic paints with a lot of water and they don't have that transparent look that a lot of people like but I think they're more representative of rocks that you see up in the Sierras.

Charlie: I noticed that you're modeling a moderately heavy layer of left-over bark on your log cars (Figure 11 previous page)?

Jack: That's prototype. Photos show these cars accumulated a lot of bark when they were in the woods and for whatever reason lumber companies did not bother trying to get it off.

What I used is something that was intended as a ground cover sold by

somebody like Noch. I don't know if it's still available. This was already colored brown and it makes a really good material for this particular purpose.

I sprinkle it underneath trees to represent bark that has fallen off the trees over a period of time and so forth. It's difficult to get these days. You might be able to do something with colored sawdust or one of those materials.

Charlie: Where did these [log] cars come from? Are they scratchbuilt?

Jack: No. Actually I initially kitbashed some log cars using Tichy flat cars and Eric Bracher (who owns Rio Grande Models) saw one of those and got intrigued with the idea of coming out with a kit for them. I've got 35 of his kits. The YV had 175 of these cars!



FIGURE 12: The Yosemite Sugar Pine Lumber Co planing mill and box factory complex in Merced Falls. This is the newest structure added to the YV railroad.



FIGURE 13: The loading dock at the planing mill and box factory in Merced Falls with the 2' gauge tram railroad.

Charlie: Jack, I understand you have a new structure in Merced Falls. Can you talk about that (Figure 12)?

Jack: Yes, this was put off for a long time primarily because I just did not have enough photos or information on it. I did have Sanborn maps that showed the general size of it but not enough photos to easily make plans.

So finally I decided I needed to finish up Merced Falls, and this was one of the main structures, so I worked up CAD drawings from all the information I had. CAD drawings alone took probably 3 or 4 days to finish and once I had them finished it was easy to scratchbuild the model out of styrene, and I had that done in about 2 days.

Charlie: How on earth do you do things so fast in styrene?

Jack: I use a lot of jigs and doing the stuff ahead of time in CAD lets me

kind of think through the process of what I'm going to do - how I'm going to accomplish things. This is a large model but it's still about a fourth the size of the prototype and it's the planing mill/box factory so they shipped a lot of sugar pine and moldings out of this plant. They had a little 2' tram railroad that ran up into the drying yards and that was modeled.

Charlie: The 2' railroad you were referring to, that's the one on the loading dock (Figure 13)?

Jack: Yeah, that's a portion of it. They used this little gravity railroad throughout the drying yards to bring wood down to the box factory/planing mill. They also used it to move lumber around in the mill and to actually load the cars. This was all finished lumber. It was loaded into boxcars one board at a time. So they would load it onto these

little carts, then wheel the carts up to the doors of the boxcar. Then 2 guys would man-handle the wood into the box car itself.

Charlie: So these guys on the loading dock (Figure 14) were loading boxcars by hand?

Jack: Yes, the one guy who's not working is actually a management type and he would grade each board as it was loaded. We have movies of them doing this and he would flip each board over and mark it and make a count and so forth.

Charlie: That was for billing purposes, to track of the lumber grades?

Jack: Correct.

Charlie: Merced (Figure 15) was the most important town on the railroad wasn't it?

Jack: Yes, their main yard was here. Offices, roundhouse were all here in Merced.

Charlie: How accurate is the trackwork here in Merced compared to what it was?

Jack: It's fairly close. They actually had a wye which was off in a field [to the left in this photo] and they could use that to turn passenger cars. The entire yard has been shrunk lengthwise but otherwise every single track that was in this yard is modeled.

Charlie: In short, the Yosemite Valley is a reasonable railroad to model because the scope is so limited compared with something like the UP.

Jack: Correct. I mean things were small, they ran fairly short trains. But what is unusual about the YV is that they also ran passenger equipment, and in order



FIGURE 15: Merced Yard on the YVRR. The railroad originated in Merced and interchanged with the SP there. Jack's model of the yard includes nearly all the tracks of the prototype.

to run Pullmans you had to have a first class railroad.

So the people that worked on the railroad knew their job, they knew how to handle stuff. It was a railroad that even into the war, 1942, they were still hiring wipers to wipe engines down. They cared what things looked like. They kept their own passenger equipment well maintained even though it was rarely used.

Charlie: This is one of the YV passenger cars. What's special about it (Figure 16)?

Jack: Well, it was built in 1907 and used for the life of the railroad. They had very few people that would ride the railroad except people who were in Pullmans. So they had this car on every single [passenger] train.

Initially it was an extra fare to ride in it. They eventually gave that up. Railfans say that if you would talk to the conductor he would usually let you in, [often] you'd have the car to yourself. Again, it was one of the things

the railroad did. They felt you needed an observation car on every passenger train and that's how they did it.

Charlie: I expect the view from the rear platform would have been spectacular!



FIGURE 14: All of Jack's structures feature an abundance of details. Two workers are preparing finished lumber to be loaded into a box car while the supervisor (left) watches carefully and grades each board.

Layout Summary

Name: Yosemite Valley Railroad

Scale: HO

Size: 20'x20'

Locale: California, Merced to Yosemite

Era: August 1939

Max grade: 2.1%

Min. radius: 22" with spiral easements

Min. turnout: #5

Trackwork: hand laid

Structures: scratchbuilt, contest models ■



FIGURE 16: Merced Yard showing the two pieces of passenger equipment owned by the YVRR, a combine (right) and observation car (left).



Jack Burgess

Jack retired five years ago as a civil engineer for the city of Newark, CA.

For four decades he has pursued his passion, the Yosemite Valley Railroad.

His model of this railroad is known around the world for its dedication to

following its prototype as exactly as possible in the confines of his (ex)garage.

Jack's knowledge of the YVRR is deferred to by the National Park Service. His railroad attracts record crowds during open houses. With his YVRR nearing completion, Jack's interests have turned toward prototype operations. He has also written a book about the Yosemite Valley titled "Trains to Yosemite."

Check out his website at www.yosemitevalleyrr.com.

 **Article feedback!**
 CLICK HERE for reader comments on this article ... 

Jack: Yeah, you know in the last part of the ride they turned the entire train on a wye at Moss Canyon which was a couple of miles from El Portal and they backed the last two miles and so that would have been spectacular. It would be early in the morning, about 8:30 or quarter to nine during the summer and its getting warm outside. You sit on the back deck, the train's backing and the

scenery's kind of opening up to you as you're backing up to El Portal.


Visiting with Jack was more than interesting and his layout just exudes craftsmanship. The only downside was a strange urge to become a prototype modeler and add interiors to all my structures! 



FIGURE 17: The YVRR observation car. Passengers paid extra to ride in this car, although a word with the conductor would sometimes succeed in getting admittance without the extra fare.



REVERSE RUNNING: The death of scratchbuilding (may it rest in peace)

Stepping outside the box with a contrary view



— by Joe Fugate

I often read posts on model railroading forums lamenting the death of scratchbuilding and how the ready-to-run trend is bad for the hobby.

“What happened to the good old days,” the poster often says, “when it took a real craftsman to be a model railroader.”

Well folks, I’ve got news for you – most people are *not a craftsman*. For the hobby to become more popular, we’ve got to convince your average person (who’s often all thumbs) that they too can be a successful model railroader.

If you want to continue shrinking our hobby, then insist on a return to the “craftsman” days in order to be a real model railroader.

I have nothing against highly skilled modelers who have honed their model building to a fine art. I love looking at

a meticulously scratchbuilt model as much as the next guy.

But model railroading should not be restricted to this approach only, and the current ready-to-run trend, I believe, is healthy for the hobby.

If you’re really paying attention, then you’ll recognize the *real shift* that’s been taking place. We’re going from model building to *layout building*.

When a layout builder visits the hobby shop or online hobby store web site, they buy more of everything – they buy track, structures, scenery materials, rolling stock, DCC stuff – the list goes on and on.

By contrast, what’s the typical model-builder going to buy when they visit the store or web site? They’ll buy some paint, some wood, styrene, or wire, and maybe a few tools.

Now which visitor leaves the biggest smile on the face of the hobby proprietor when they visit? The layout builder, of course!

Being the owner of a large layout myself, the ready-to-run trend is most welcome. If I can find the specific item I’m looking for in ready to run form, I’ll often pony up for it because it saves me time.

Sooner or later most modelers have the reality attack that all-scratchbuilt modeling and large finished layouts don’t go together unless you’re independently wealthy and can do your modeling full time.

The more you can buy, the more likely it will be that you can actually get that dream layout to a reasonable level of completion.

That’s why the now defunct magazine *Mainline Modeler* (MM) used to always puzzle me. The name *Mainline Modeler* suggests serious class 1, big-time railroading.

Yet what was the typical MM article? A step-by-step scratchbuilding piece. Talk about a disconnect!

I have to wonder if that’s one reason why MM didn’t survive in today’s layout builder market. Scratchbuilding everything on a serious class 1 railroad layout just *is not* realistic.

There’s another interesting trend today that should warm the hearts of those lamenting the death of scratchbuilding – and that’s the trend toward more prototypically accurate modeling. If you want to model a prototype correctly down to the gnat’s eyebrow, it’s simply not possible to buy everything.

You will need to scratchbuild – or at least kitbash a number of your signature structures and rolling stock.

What those lamenting the death of scratchbuilding don’t seem to realize is that scratchbuilding isn’t really dead – it’s simply changed focus. Because you can buy so much today in ready-to-run form, it’s actually become practical to do far more accurate prototype modeling.

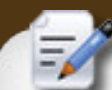
You can buy a large part of your “generic” cars and structures ready-to-go, and focus your scratchbuilding/kit-bashing efforts on the signature items that identify your layout as that *specific prototype*.

In my opinion, there’s never been a better time for Mr. Joe Public or Mz. Jane Public to enter the hobby of model railroading.

Because the arcane craft of scratchbuilding has finally become a non-requirement, more people than ever can enjoy model railroading “in the large” and can fulfill their dreams of finishing a layout. And the hobby vendors are smiling every time today’s layout builders walk in or hit their web site!

So to scratchbuilding as a mainstream model railroading requirement, I say good riddance!

May it rest in peace. ☑



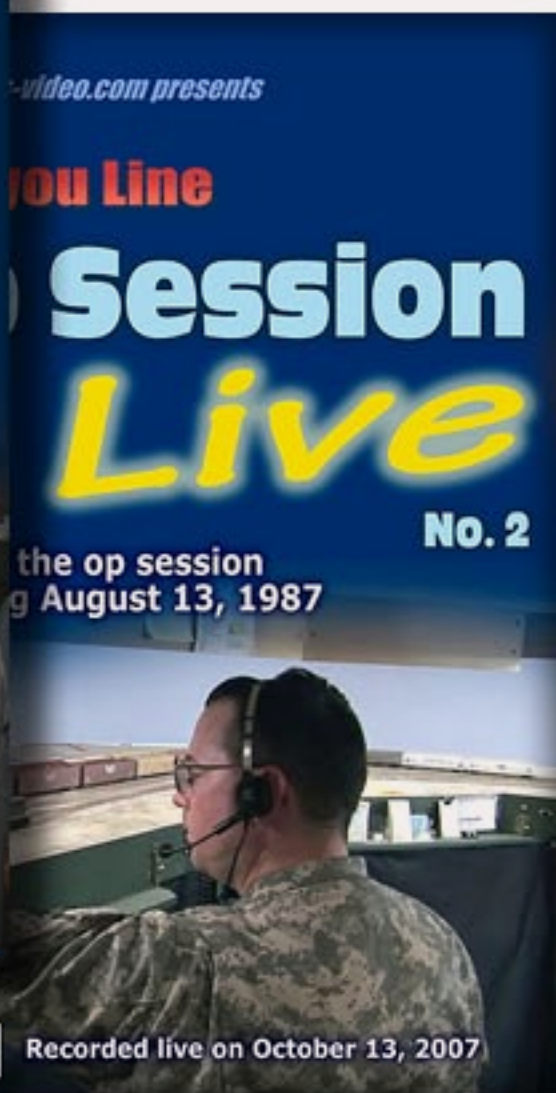
Article feedback!

[CLICK HERE](#) for reader comments on this article ...

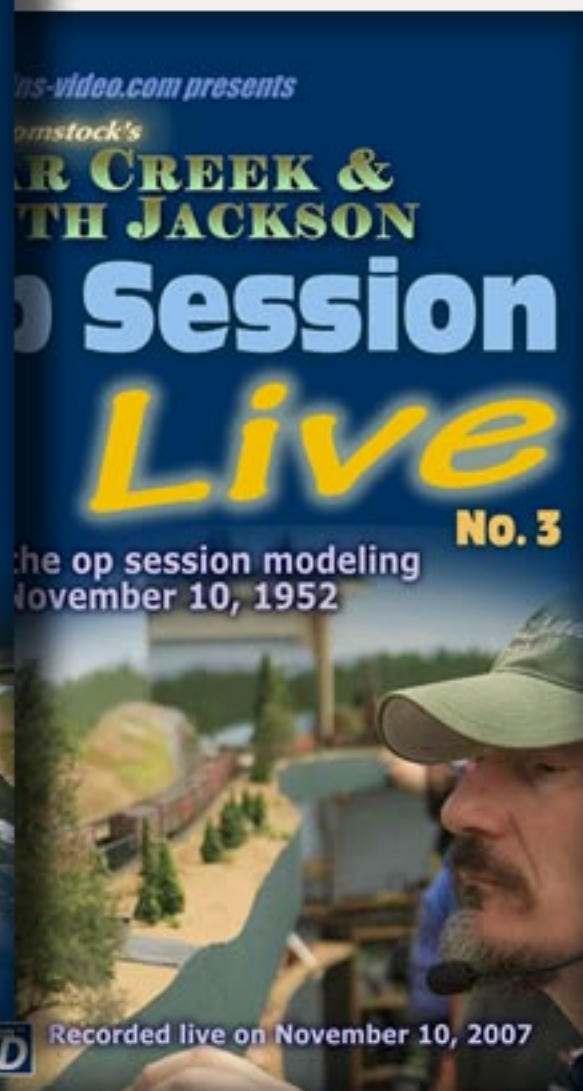
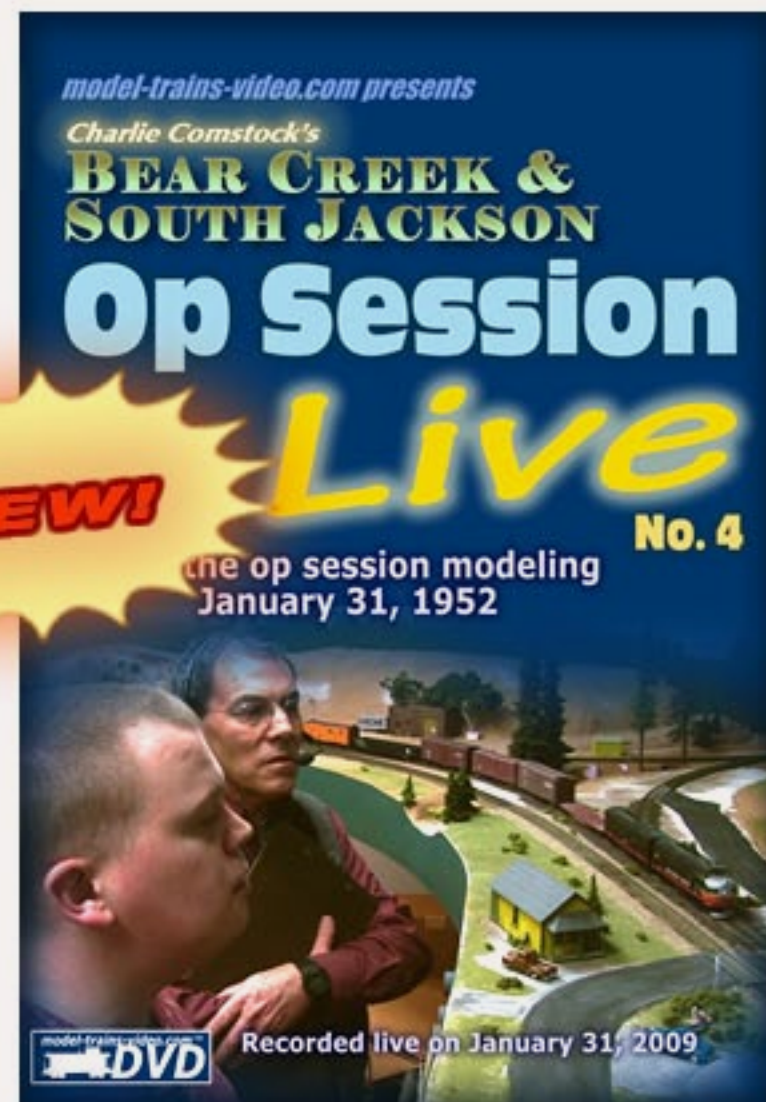


model-trains-video.com

Get your LIVE op session videos here ...



**Joe Fugate's
1980's Siskiyou Line**



**Charlie Comstock's
1950's BEAR CREEK &
SOUTH JACKSON**

\$40 TAKES ALL FOUR! Free shipping!
Get these premier ops "reality" videos today!

click here
**LEARN
MORE** 



DASHBOARD

Clickable ISSUE INDEX

[Editorial - Publisher's Editorial](#)

[Editorial - Reverse Running](#)

[Electronics - R/C Servos](#)

[N Scale - Comme-N-tary](#)

[Narrow Gage - The Lite and Narrow](#)

[News - July Newsletter](#)

[News - New Media Modeler](#)

[Layouts - Jack Burgess' Yosemite Valley](#)

[Layouts - Up the Creek](#)

[Rolling stock - Deluxe track cleaning car](#)

[Rolling stock - Kato covered hoppers](#)

[Rolling stock - Sergent couplers](#)

[Structures - Telephone poles](#)

[Track plan - Alcos in the Alcove](#)

[Trackwork - Finishing turnouts](#)

[Other - Advertiser's index](#)

[Other - Back cover](#)

[Other - Cover](#)

[Other - Table of Contents](#)

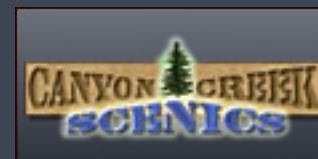
SPONSORING ADVERTISERS



click to learn more about this sponsor



click to learn more about this sponsor



click to learn more about this sponsor



click to learn more about this sponsor



click to learn more about this sponsor



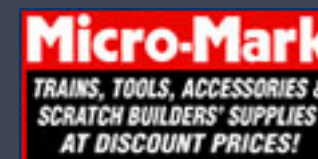
click to learn more about this sponsor



click to learn more about this sponsor



click to learn more about this sponsor



click to learn more about this sponsor



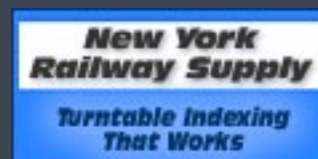
click to learn more about this sponsor



click to learn more about this sponsor



click to learn more about this sponsor



click to learn more about this sponsor



click to learn more about this sponsor



click to learn more about this sponsor



click to learn more about this sponsor



click to learn more about this sponsor



click to learn more about this sponsor