

HAVING FUN WITH TRAINS

MARCH 2025 | FREE

MRH

MODEL RAILROAD HOBBYIST

ALSO:

- Control 25 things with one input
- More interiors with Roomettes
- Little-known decaling tricks
- Ops: What trains to run, part 3
... and more inside!

Nicolo Platas' ...

NPSF revives rail service over the Raton Pass Line

► **READ NOW**



ADAPTIVE EDITION
Landscape or Portrait depending on screen size



DOWNLOAD

TABLE OF CONTENTS

This is the screen-adaptive PDF version of MRH magazine

This PDF will try to fill the screen. If the screen is wide enough, it displays two facing pages (emulating the old landscape format), otherwise it displays one page in portrait.

On mobile devices, if you change your device orientation, the PDF adapts to fill the screen with either a portrait or a landscape view as appropriate.

WORKS BEST WITH ...

- Windows: open with Acrobat or Firefox
- Mac: open with Preview, Acrobat, or Firefox
- Linux: open with Acrobat or Firefox
- Apple iPad or iPhone: open with SideBooks app (free)
- Android tablet or phone - open with SideBooks app (free)

If you're not seeing the PDF adapt, then your PDF viewer lacks the adaptive display feature. Please use one of the recommended free PDF viewing apps listed above to get the screen adaptive behavior. Or try the Wide Edition instead.



ALL ABOARD FOR FUN!



#15 000 100
Trainkids Glow in the Dark
Passenger Train Set

- Powered Locomotive and First Class Battery Car
- 2 Passenger Cars and Unpowered Locomotive
- 38" x 56" oval incl. 12 Pieces of Curved & 4 Pieces of Straight Track
- Remote Control operated
- Headlight, horn, bell & "Welcome Aboard" announcement

NEW GLOW IN THE DARK TRAINSETS & ACCESSORIES



The NEW Magic Rerailer (#15 000 110) makes it easy for little hands to get their trains back on track!

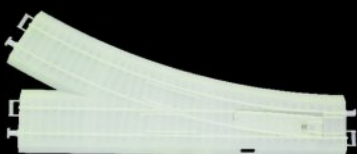
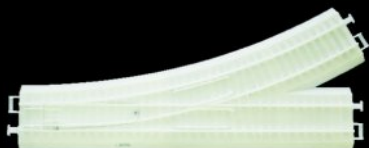

Our separate sale left (15 000 108) and right (15 000 109) switches are available individually as well as in the #15 000 107 switch set.

CHECK OUT THESE
FUN PRODUCTS & MORE!

CLICK HERE!

FOR MORE INFORMATION OR TO LOCATE A DEALER, PLEASE VISIT WWW.ATLASRR.COM.
ATLAS MODEL RAILROAD CO, INC. • 378 Florence Ave., Hillside, NJ 07205



REGISTER
(free)

[INDEX](#)

[TABLE OF CONTENTS](#)

STAFF

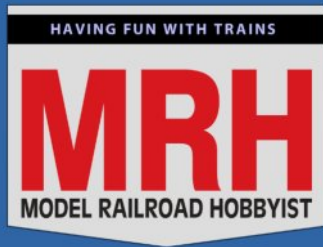

Model Railroad Hobbyist |

February 2025 | #180

Editorial Staff



Joe D. Fugate, Publisher and Editor



James Regier, Assistant Editor



Patty Fugate, Pasteup and Layout



Richard Bale, News and events



Jeff Shultz, News and events, Tech Assistant



Mike Dodd, Copy Editing

Get more issues like this

GIVE IT A LIKE



ISSN 2152-7423

1.1 Feb 16

Advertising



Les Halmos, Account Manager



Jean-François Delisle, Marketing Assistant

Regular contributors

Eric Hansmann, Contributing editor
Jim Six, Limited Modeler column (RE)
Ken Patterson, Reporter-at-Large

Rotating Columnists (RE)

Greg Baker, Getting Real column
Al Daumann, Getting Real column
Jeff Johnston, Getting Real column
Mike Rose, Getting Real column
Jim Providenza, Getting Real column
Tony Thompson, Getting Real column

Published for the glory of God. [What's this?](#)

MRH SPONSORS



Model Railroad Hobbyist | February 2025

A - L



acculites.com



railroadhobbyshow.com



www.atlasrr.com



bachmanntrains.com



berretthill.com/trains



blairline.com



deluxematerials.co.uk



www.digitrax.com



esu.eu/en



handlaidtrack.com



iascaled.com

[Vendors: Get your clickable logo on these pages ...](#)



REGISTER
(free)

[INDEX](#)

[TABLE OF CONTENTS](#)



**IF THIS
DOESN'T GET YOU
TO TRY DCC...
NOTHING
WILL!**

**Click here for
details of the DCC
system designed for
the new DCC modeler ...**



M O D E L R E C T I F I E R C O R P O R A T I O N

360 Main Street, Suite 2, Matawan, NJ 07747 • Phone: 732-225-2100 • www.modelrectifier.com

FOUNDED BY ROY C. GELBER

■ Train Controls

■ Model Railroad Accessories

■ Plastic Model Kits

■ Scenery

■ Educational Kits



REGISTER
(free)

[INDEX](#)

[TABLE OF CONTENTS](#)



Publisher's Musings: Need help with Shenware ...

JOE FUGATE

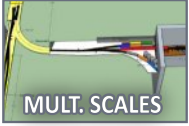

MULT. SCALES

MRH Website this month: Proto:48 switching layout, ...

Compiled by JOE FUGATE



ALL SCALES

Let's talk ops: What trains to run, part 3

JOE FUGATE



ALL SCALES

What's Neat: Sam Syzdek's nicely scenicked layout, ...

KEN PATTERSON



ALL SCALES

Electrical Impulses: Control 25 things with one input

BLAIR SMITH



H0

NPSF revives rail service over the Raton Line

NICOLO PLATAS and DAN SHEPARD



H0

Detailing a structure interior with a Roomette kit: 2

JEFF PALMER



MULT. SCALES

Savvy Modeler online: Cool decaling tricks

Compiled by the MRH STAFF



February 2025 news and events

RICHARD BALE and JEFF SHULTZ



A NEW ERA BEGINS

SCALETRAINS GOES '50s

HO
1:87 SCALE

INTRODUCING THE ALL-NEW EMD SD7 & SD9



SOUTHERN PACIFIC/BLOODY NOSE/SD7R

**SD7 ROADNAMES AND
PAINT SCHEMES INCLUDE:**



SOUTHERN
PACIFIC



CONRAIL/CAN OPENER

**SD9 ROADNAMES AND
PAINT SCHEMES INCLUDE:**



**SCALE
TRAINS**

CLICK THIS AD TO PREORDER NOW

SCALETRAINS.COM



© 2025 ScaleTrains, Rivet Counter, railroad, road number, and era-specific details. Select Retailer and respective logos are trademarks of ScaleTrains.com, Inc. This product is made under trademark license from Union Pacific Railroad.



REGISTER
(free)

[INDEX](#)

[TABLE OF CONTENTS](#)

PUBLISHER'S MUSINGS



Model Railroad Hobbyist | February 2025

JOE FUGATE NEEDS YOUR HELP SAVING SHENWARE'S SUPERB OPS SOFTWARE NOW THAT OWNER PETER WHITE HAS PASSED ...



IN THE LAST YEAR, PETER WHITE, AUTHOR OF THE POPULAR SHENWARE OPS SOFTWARE PACKAGE, PASSED AWAY. Through a series of conversations with Peter's widow and some of his most loyal users of the Shenware software, MRH has become the "heir apparent" of the Shenware software in CD form.

However, much to our dismay, we were not able to locate Peter's source code or his software keys master and his wife has already sold his computer. As a result, all we have is a complete collection of all the Shenware software release CDs from version 5 to version 8. But without keys, they're just trial software that will quit working after 30 days.

This is where we need your help. If you have purchased any version of Shenware from Peter and have the software key for it, [please contact us](#). Select **Feedback** and include how we can contact you (both phone and email, please) and we will get back to you.

It appears Peter used a specific software key for each version of the software, so if we can build a collection of the keys by version, then we can distribute this software at an affordable price for anyone who wants it.

What's in the Shenware software package

Over the years, Peter kept adding more little goodies to the Shenware software package like a fast clock and a scale dimension converter. But the real gold in this package is the MiTrains [1] inventory program and the Waybills program with its prototype North American railroad industry database.

What I do is I maintain my railcar inventory using a spreadsheet, but I use the MiTrains field names for my columns. MiTrains has a nice import feature that lets you copy rows out of any Excel Spreadsheet and paste them into the program. It's quite easy and very handy.

Category: [Edit]
04: Freight Cars and all sub categories.

Detail Area (Format: ShowAll): [Edit]

Cat	Item	Qty	Pack
04	04.00035	1	1

Description:
Manufacturer:
Model:
Supplier:
Location: Scale:

Road Name: COP City of Prineville
Road No.: 7341
Herald:
Color: Orange

Construction: AAR Code: XM Boxcar
Condition: Coupler:
Index 1: Index 2:
Index 3: Index 4:
Index 5: Index 6:

Issued Date: List (Each): Qty x Highest Amt:
Purch. Date: Cost (Each):
Appr Date: Appraised:
Auct. Date: High Bid:
Add On Show AddOn (0 Items): .00
Sell Price: Sold Price:
Maint. Date: 4/19/2009 Maint. Period:

Notes:

Print Print Label? Print Added: 2/12/2025 Updated: 2/12/2025
(This data is automatically saved when you do something else.)

Item	Road Name	Road No.
04.00031	SP Southern Pacific	228617
04.00032	RBOX Rail Box	10001
04.00033	SP Southern Pacific	355132
04.00034	SP Southern Pacific	355470
04.00035	COP City of Prineville	7341
04.00036	MP Missouri Pacific (MoP)	724399
04.00037	CNW Chicago & NW	178688
04.00038	DRGW Denver & Rio Grant	15641
04.00039	CNW Chicago & NW	178633
04.00040	UP Union Pacific	73849
04.00041	WP Western Pacific	12005
04.00042	MP Missouri Pacific (MoP)	710894
04.00043	UP Union Pacific	52190
04.00044	SP Southern Pacific	328000
04.00045	MILW Milwaukee Road	62155
04.00046	DRGW Denver & Rio Grant	15609
04.00047	SP Southern Pacific	400897
04.00048	BCIT British Columbia Rail	600608
04.00049	UP Union Pacific	215663
04.00050	RI Rock Island	27205
04.00051	SSW Cotton Belt	67768
04.00052	ATSF Santa Fe	12369
04.00053	ATSF Santa Fe	93794
04.00054	ATSF Santa Fe	100801

1. Shenware MiTrains "inventory" main screen.



REGISTER
(free)

[INDEX](#)

[TABLE OF CONTENTS](#)

NATIONAL STEEL CAR 4300 CuFt POTASH SERVICE HOPPERS



4275 Cu. Ft. Version 1 - Mosaic (MOCX) (Gray with Patchout). Pink Panther Car. 6 Body Panels. Continuous hatches. Road Number # 499170 (SKU 11-32001002-Panther).

6 BODY PANELS

CONTINUOUS HATCHES



Version 9 - Mosaic Company (MOCX) (Burnt Orange with White Lettering/ Yellow Visibility Stripes) 6 Road Numbers (one 6 car set) Set A (SKU 11-32009003).

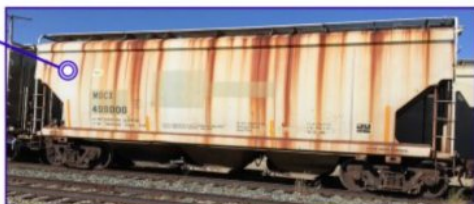

4275 Cu. Ft. Version 1 - Mosaic ex-Canpotex (PTEX) (Gray with Black Lettering, patched Green Logo, Yellow Visibility Stripes). 6 Body Panels. Continuous hatches. 6 Road Number Set (includes Jurassic Car) (SKU 11-32001005).



NORTH AMERICAN RAILCAR CORPORATION

A DIVISION OF PACIFIC
WESTERN RAIL SYSTEMS

pwr's.ca



Do You Know The Difference Between...StreakingGrime and Industrial Streaking Grime?

Ammo Rail Center Does.



Stay tuned!

... coming soon to

RIH
Rock Island Hobby

Rail Center's broad line of weathering effects are thoroughly and precisely matched to the real thing. Our washes, paints, and pigments capture the subtle variations and authentic hues of real life.

PUBLISHER'S MUSINGS | 3



2. The Shenware software lets me print out car cards such as the ones shown here. When I check the car, I stamp a date on the back.



REGISTER
(free)

[INDEX](#)

[TABLE OF CONTENTS](#)

BACHMANN®

HO
SCALE

DISCOVER THE GREAT LITTLE RAILWAYS OF WALES



New and Upcoming Models in HO_N30/009 Scale from Bachmann

The little railways of Wales have captured the imagination of enthusiasts from across the globe for over 100 years, with lines such as the Tallyllyn Railway and Ffestiniog continuing to thrive as popular tourist destinations today. Bachmann is delighted to introduce a new range of HO/OO Scale models representing locomotives and rolling stock from these fabled lines, scaled to their appropriate narrow gauge dimensions. Designed using prototype references and through site visits, these authentic models operate on N Scale track for versatility and ease of use - no specialty track required. Climb aboard Bachmann's HO_N30 line for a journey through the bucolic fields, hills, villages, and fascinating industrial history that define the Welsh landscape.

Fletcher, Jennings & Co. 0-4-2ST "TALYLLYN" • Shipping Now



BLACK

Item No. 59101

NEW



RED

Item No. 59102

NEW



GREEN

Item No. 59103

NEW

Features include:

- New and existing tooling
- Die-cast metal construction
- Quiet, smooth running mechanism
- Highly detailed painted body with precision graphics
- International-style hook-and-loop couplers
- Blackened and painted machined metal wheels with metal drivers

Tallyllyn Railway Coaches • Arriving Spring 2025



CARRIAGE #1

Item No. 77502

NEW



CARRIAGE #2

Item No. 77503

NEW



CARRIAGE #4

Item No. 77504

NEW

Features include:

- Two authentic coach designs
- Highly detailed painted bodies with precision graphics
- Clear plastic windows
- International-style hook-and-loop couplers
- Blackened machined metal wheels

Coming Later in 2025:



Hughes's Locomotive & Tramway Engine Works 0-4-2ST "SIR HAYDN"



Ffestiniog Railway Coal Waggons

Scan the QR Code to see all of Bachmann's HO_N30 Trains



BACHMANN INDUSTRIES, INC.

1400 East Erie Avenue; Philadelphia, PA 19124 USA

www.bachmanntrains.com



MRHMAG.COM

[INDEX](#)

[TABLE OF CONTENTS](#)

What makes the MiTrains inventory program really shine – you can print car cards [2] from your car inventory list [3]. You can control the font and placement, you can even add a photo

Exit Set Print? to Print Set Print? to Done Print Copy Car Cards (AAR Type, Roadname, Road No., plus) using Car Cards for 2"x3" Waybills forms in Portrait mode. LANDSCAPE recommended.

Print: One Car Card per item
 One Car Card per Road Number

Show: Items to be printed only All Items

282 CAR CARDS to be printed out of 282.

Print ?	Item	Road Name	Road No.
Print	34.00024	SJL St Johnsbury & Landille	8036
Print	34.00025	SP Southern Pacific	243124
Print	34.00026	SP Southern Pacific	243125
Print	34.00027	SSW Cotton Belt	67373
Print	34.00028	SP Southern Pacific	228620
Print	34.00029	SP Southern Pacific	264464
Print	34.00030	SSW Cotton Belt	67777
Print	34.00031	SP Southern Pacific	228617
Print	34.00032	RBOX Rail Box	10001
Print	34.00033	SP Southern Pacific	355132
Print	34.00034	SP Southern Pacific	355470
Print	34.00035	COP City of Prineville	7341
Print	34.00036	MP Missouri Pacific (MoPac)	724399
Print	34.00037	CNW Chicago & NW	178688
Print	34.00038	DRGW Denver & Rio Grande West	15641
Print	34.00039	CNW Chicago & NW	178633
Print	34.00040	UP Union Pacific	73849
Print	34.00041	WP Western Pacific	12005
Print	34.00042	MP Missouri Pacific (MoPac)	710894
Print	34.00043	UP Union Pacific	52190
Print	34.00044	SP Southern Pacific	328000
Print	34.00045	MILW Milwaukee Road	62155
Print	34.00046	DRGW Denver & Rio Grande West	15609
Print	34.00047	SP Southern Pacific	400897
Print	34.00048	BCIT British Columbia Rail	600608
Print	34.00049	UP Union Pacific	215663
Print	34.00050	RI Rock Island	27205
Print	34.00051	SSW Cotton Belt	67768
Print	34.00052	ATSF Santa Fe	12369
Print	34.00053	ATSF Santa Fe	93794
Print	34.00054	ATSF Santa Fe	100801
Print	34.00055	BN Burlington Northern	281163
Print	34.00056	ATSF Santa Fe	141708
Print	34.00057	ATSF Santa Fe	142306
Print	34.00058	ATSF Santa Fe	143307
Print	34.00059	ATSF Santa Fe	166293
Print	34.00060	BO Baltimore & Ohio	480018
Print	34.00061	CS Burlington Route	21562
Print	34.00062	CBQ Chic Burlington & Quincy	130258
Print	34.00063	CNW Chicago & North Western	95057
Print	34.00064	CNW Chicago & North Western	106828
Print	34.00065	CNW Chicago & North Western	106820

Labels Car Cards Forms Font

Car Cards w/pictures (AAR, Rprt Marks, Road No)
 Car Cards (AAR Type, Roadname, Road No., plus)

Line 4: Use value in 14 Color
Line 5: <none>

Print line headings

Return Empty Car Add Delete

<none>
<-Return To only>
EUGENE

Note line 1: <none>
line 2: <none>

If data is too long for a single line:
 truncate it overflow one line.

Preview:

AAR: **XM Boxcar**
Road: **SP Southern Pacific**
No.: **228620**
Color: **Brown**

EMPTY CAR
Return to
EUGENE

282

3. One powerful feature of the MiTrains inventory software is its ability to print car cards.

NEW from
the

**Model
Railroad
Hobbyist
Store**

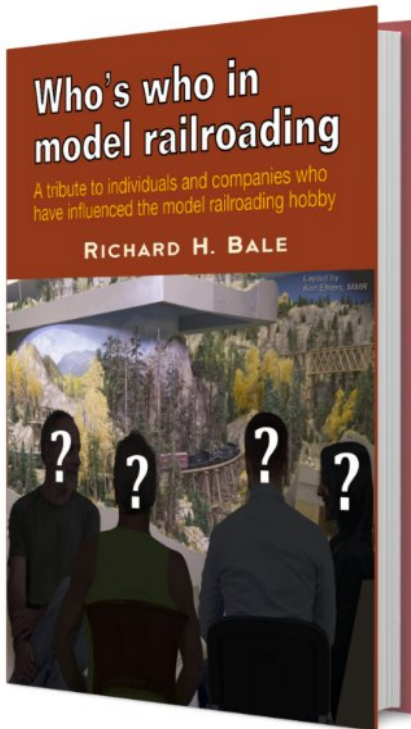

Michael Gross, popular actor and model railroad industry spokesperson ...

"All in all, *Who's Who in Model Railroading* is a wonderful piece of history. I have had many questions over the years about 'Whatever happened to ... (fill in the blank)?' And this book answers them. It is encyclopedic, and very well done."

172 pages

Available
NOW

Available to order
on Feb 25th

Available to order
on March 15th

eBook • Paperback • Hardbound

~~\$19.99~~

\$10.77

~~\$31.99~~

\$24.77

~~\$45.99~~

\$36.77

LEARN MORE ►

Save \$25.00



with code **SuperSale25**

RAILWAY PROTOTYPE CYCLOPEDIA Volume 36

By Pat Wilder 385 pages,
500 B&W photos,
drawings, trade ads,
patents, roster,
bibliography. Softcover.

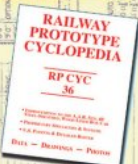

Reg. \$90.00 **\$65.00 postpaid**
with code thru April 30, 2025

Click for info and to order:
Ron's Books

When talking to
hobby vendors,
please remember
to mention MRH.

of the car if you included one in the inventory.

You can also add custom lines to the car card such as "When empty, return to EUGENE" on my Siskiyou Line layout.

I just get some manila card-stock at an office supply and print away on my printer, getting eight cards to a sheet. I cut them out on a paper cutter, then use a metal straight edge to get a nice crisp fold for the waybill pocket.

I use a bit of transparent tape (the dull finish stuff) to tack the edges of the card pocket in place [2]. Voila, car card all set to go for holding waybills.

Making waybills

Shenware also includes a waybills application [4]. What makes this app really shine is the included North American railroad industry database [5] – yes, you read right!

Rather than just make up fake destinations for your waybills, you can select from real prototype industries that are or have been served by a railroad spur.

How cool is that?



REGISTER
(free)

[INDEX](#)

[TABLE OF CONTENTS](#)

Make it run like a

Dream ROLLING STOCK

102 pages

By Joe Fugate

PRE-SPRING
SPECIAL

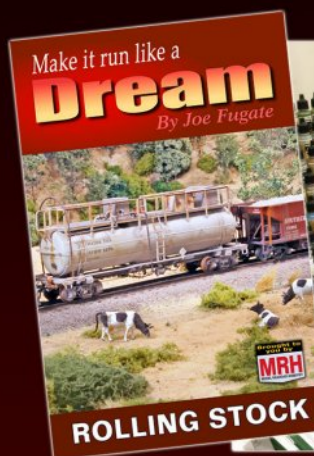

TOPICS INCLUDE: Setting standards • Building a test track • Wheelset/truck issues • Coupler issues • Carbody issues • Car weight considerations • Better maintenance procedures • Performance diagnosis & debugging • Special considerations

Click me to
Get eBook NOW >>

~~\$14.99~~ \$9.99

Format: Landscape and Portrait
PDF

Click me to
ORDER PAPERBACK >>

~~\$31.99~~ \$27.77

FREE shipping in US!
Foreign shipping 50%

Other books in this series: TRACKWORK (available now) and LOCOS (Q2 2025)

Edit View

Select AAR Car Type? 25 Route? 2
 BX Express box car
 FC TOFC car
 FD Flat car, depressed
 FM Flat car

Home Locations? 222 Find
 Zone Location
 All Locations
 10 Lubbock Yard
 zzzzz Off Line Industries
 20 South Plains

Home Industries? All Off Line 0 To From
 Locn/CLIC Name City
 10-04-00 empty car yard Lubbock
 10-08-01 Federal Cold Storage Co Lubbock
 10-08-02 Federal Cold Storage Co Lubbock
 10-09-01 West Texas Plastics (Door 1) Lubbock
 10-09-02 West Texas Plastics (Door 2) Lubbock
 10-09-03 West Texas Plastics (Door 3) Lubbock
 10-10-00 Diesel Service Lubbock
 20-03-00 Team track South Pls
 20-04-01 Cargill Grain South Pls
 20-06-00 BN Interchange South Pls
 20-08-01 Farmers Coop (Door1 Rcvr) South Pls
 20-08-02 Farmers Coop (Door2 Rcvr) South Pls

Notes? 4 Commodities? 677 MTY
 Note
 [Clear Note]
 HasMat: Keep 4 cars from lock
 Ice empty before spotting
 Top up ice after loading

Preview

Select Waybill Print? WA Num? Description? Title Format?
 << < 1 >> >> [Done] 1000 Sample 3 cycle way Destination

1.MTY>Cargill, 2.Grain>OffLine, 3.MTY>Cargill, 4.MTY>OffLine

Search: Search?

Page: 1 2 3 4 Next?

Color Title Bars by TO Location Set?

LO South Plains 1
 Via: BN Interchange
 To: South Plains, TX
 Cargill Grain
 CLIC: 20-04-01
 From: Lubbock Yard, TX
 empty car yard
 CLIC: 10-04-00
 Contents: MTY

LO South Plains 3
 Rte: BLM>MIRR
 To: South Plains, TX
 Cargill Grain
 CLIC: 20-04-01
 From: Haverhill, MA
 Haverhill Grain & Coal Co
 Contents: MTY

LO WAYBILL 2
 Rte: MIRR>BEM
 Via: BN Interchange
 To: Haverhill, MA
 Haverhill Grain & Coal Co
 From: South Plains, TX
 Cargill Grain
 CLIC: 20-04-01
 Contents: Grain

LO WAYBILL 4
 Rte: MIRR>CLO
 Via: BN Interchange
 To: Brethren, MI
 Hillsamer R
 From: South Plains, TX
 Cargill Grain
 CLIC: 20-04-01
 Contents: MTY

Last updated Mar 7, 2012

4. Shenware waybills main screen.

File Format Options Help
 Exit Edit Load this window at startup.

Search: Search State? for
 OR
 Show: All records Search results only

Entries for: Highcroft Orchards
 Row S/R Commodity
 15169 Pears (Piggy Brand)

All Records
 Insert To Industry Insert From Industry Insert Commodity
 Sorted on State*
 Put cursor between column headings to resize.

Row	Era	Industry*	City*	State*	Road*	SR*	Commodity*	STCC	Recip	Source
15168	1996	Medite	Medford	OR	SP		Particleboard, chipbo	2499610		SPwayb
15169	1950	Highcroft Orchards	Medford	OR	SP		Pears (Piggy Brand)			jewett
15170	1978	Wills Bros Shingle Co	Mill City	OR	SP		Shingles			jewett
15171	1978	Newberg Shingle Co	Brewster	OR	SP		Shingles			jewett
15172	1962	Pacific Telephone Co	Klamath Falls	OR	SP		telephone company			hitGN
15173	1962	Consolidated Freight	Klamath Falls	OR	SP		truck line			hitGN
15174	1994	Unocal Chemical Div	Rivergate	OR	SP		Urea, weed killer	2818170		SPwayb
15175	1978	Dillard Veneer Co	Dillard	OR	SP		Veneer			jewett
15176	1995	Tree Source	Central Point	OR	SP		Veneer	2421170		SPwayb
15177	1990	Western Ash	Portland	OR	SP	R	Fly ash	4011208		butts

19000 industries * columns used by Waybills. Chk: not used; Locn/CLIC: O/L=Off Line Prototype Industry, other=Home Industry

5. Shenware industry database screen. This North American railroad industry database is invaluable for making waybills.



REGISTER
(free)

[INDEX](#)

[TABLE OF CONTENTS](#)

FAST TRACKS

Build your own trackwork easily, quickly, and affordably.

TRACK BUILDING SYSTEM



I am a die-hard hand laying railroad track aficionado with many years experience. I decided to try the Fast Tracks systems for my most recent Sn3 railroad. I was quite frankly astounded that I had not done this before. - Michael M.

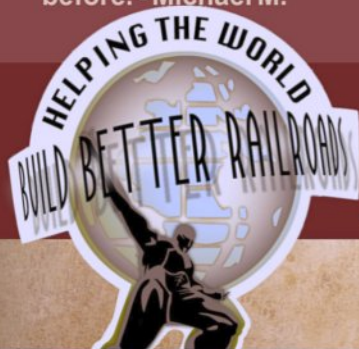

Over 5,000 unique products.

• Easy ordering •

shop online 24/7 • handlaidtrack.com

1-888-252-3895

service@fast-tracks.net



THE AMAZING CF7 LOCOMOTIVE

**HO
SCALE**



Mo+Power
UNINTERRUPTED LOCOMOTIVE POWER

ESU **LOK SOUND**
EST. 1999



**5 cab
variations**



**Cannon and Co.
licensed fans**

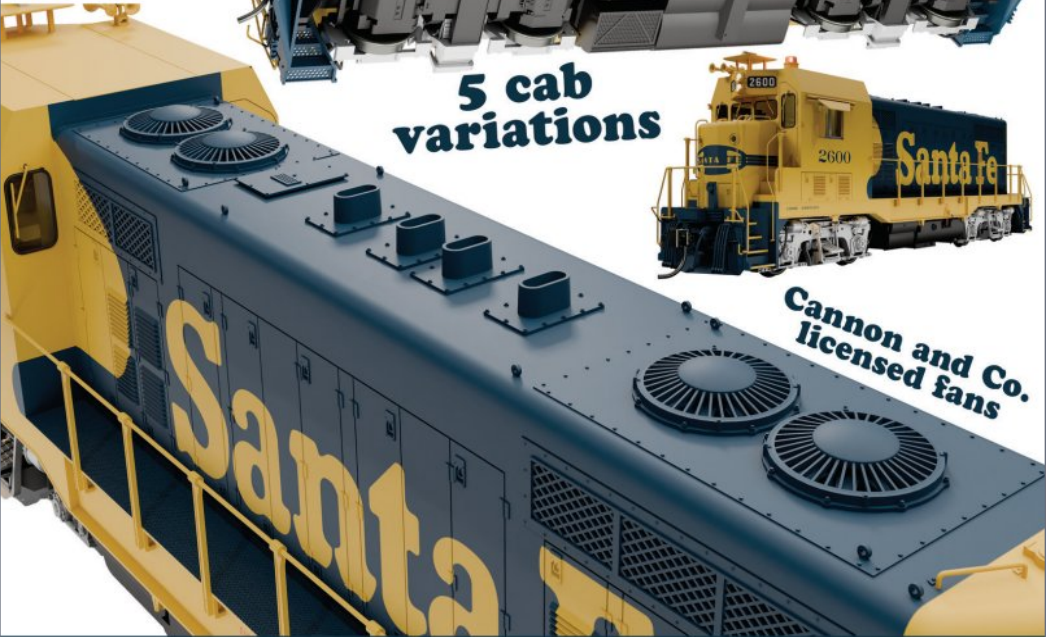

RAPIDO

CLICK HERE



REGISTER
(free)

[INDEX](#)

[TABLE OF CONTENTS](#)

Summary

You can see why we want to do everything we can to save this amazing piece of software for the hobby.

Once again, if you own some version of the Shenware software and you have a registration key for it, please [contact us](#) (select **Feedback**).

We will keep these keys in confidence, and we will make the Shenware software available for purchase through the MRH Store. Once we have the proper registration keys for each version, we will automatically email new customers the key when they buy the software.

We plan to offer this software primarily as a service to the hobby and price it very affordably. Help us keep Peter White's legacy to the hobby alive and not see it go to waste!

Get more articles like this

GIVE IT A LIKE



Did you see this article?

in the **FEBRUARY 2025 MRH RUNNING EXTRA!**

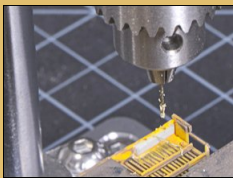

**An affordable precision
micro drillpress**

Get full eBook now ▶

← click
here

Each eBook has 80-100 pages



**RUNNING
EXTRA**

Get the latest Model Railroading News, Tips, Reviews & Opinions



**Our iTunes feed has changed search for
"Crew Call with Mike Rose" to receive the latest episodes!**

www.themodelrailroadpodcast.com

Host:

Mike Rose: www.mrhobby.com

**Don't Miss our Monthly Interviews
& Product Announcements**



LAST ISSUE LIKES

Most liked articles in [January 2025 issue](#) of *MRH* are:

- 1st** Steve Davis' KCS mushroom layout
- 2nd** Let's talk ops: What trains to run, part 2
- 3rd** Electrical Impulses: Multimeters for model railroaders

Most liked articles in [January 2025 issue](#) of *Running Extra ...*

- 1st** Limited Modeler: New ideas for freight cars
- 2nd** Winter model train photo extravaganza
- 3rd** Getting Real: Let's look at car routing

If you want more of this type article, then like the article!
Click the *Give us a like* or *comments* button on each article and press the like button on the article's forum page if you want to see more articles like these. ■



REGISTER
(free)

[INDEX](#)

[TABLE OF CONTENTS](#)

Every little bit helps!

Registered MRH readers
get **another** 10% off with
the coupon code here:



Reveal my
coupon code now!

[click here](#)

That's right, on top of our
other sales and discounts, use
this coupon code to get
YET ANOTHER 10% off!



TMTV sale offers

[click here](#)







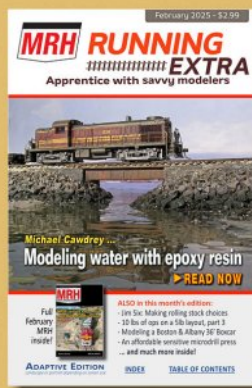

MRH Store sale offers

[click here](#)

In

MRH**RUNNING
EXTRA****February issue ...****All meat: zero ads!****TABLE OF CONTENTS | RUNNING EXTRA**

Issue 75: February 2025

	Publisher's Welcome: All-Wago layout wiring JOE FUGATE
	Limited Modeler: Making rolling stock choices JIM SIX
	Getting Real: 10 lbs of ops on a 5 lb layout: 3 AL DAUMANN
	Modeling water with self-leveling epoxy MICHAEL CAWDREY
	Model a Boston & Albany 36' Boxcar CHARLIE DUCKWORTH
	Ah-Hah Moment: An affordable precision microdrill press JOE FUGATE

Buy February eBook - \$2.99
75 pages

store.mrhmag.com

Also includes
184-page MRH
in the back!



REGISTER
(free)

[INDEX](#)

[TABLE OF CONTENTS](#)

Best of the

MRH FORUM

Forum

MRH
mrhmag.com

**THIS
MONTH**

Model Railroad Hobbyist | February 2025

Compiled by **JOE FUGATE**

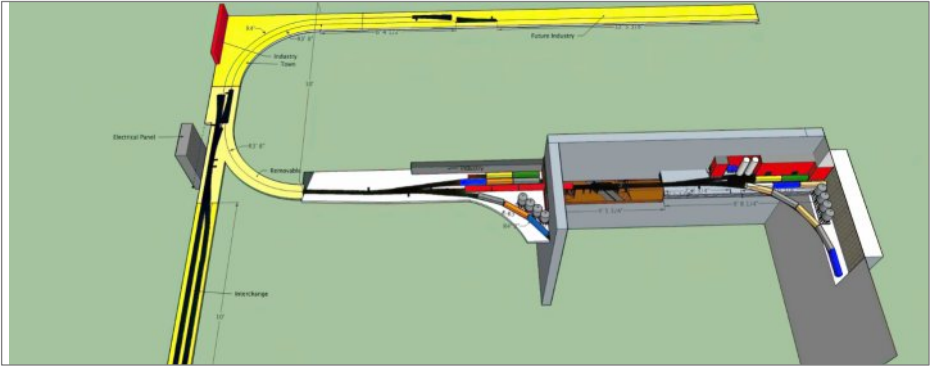

Proto:48 switching layout

MRH forum member **EGRX** (Eugene G.) has a blog on the Proto:48 switching layout he's building. Eugene says:

"This blog will cover the repurposing of two 7' partially completed Proto:48 modules into a completed (this is a first for me) 11' 2" office switching layout."

We especially love Proto:48 because it's a good excuse for modeling the correct track gauge in O and adding great wheel and track detail that's so easy to see in O scale. Check out Eugene's blog for more.



[View the full blog on the MRH website](#)

▶ **MRH'S MONTHLY GREAT MODELER POSTS**



1. *MRH* Author **J Emerson** (Joe Thistlewood) posted this amazing photo of Addison Marine (Bar Mills kit) on his Emerson Coast Railroad blog.

New England ocean-front layout

MRH Author **J Emerson** (Joe Thistlewood) has a long-running blog documenting the construction of his latest layout from bare room to virtually finished layout. His latest photos of Addison Marine in Rickety Cove are spectacular [1]!

“The Addison structure was by far the most finicky of the kit, but the result was worth it. I added two LEDs to light the underside, I did not want to leave the neat corner office structure in the dark for night pics. My roof is removable, done so I could wire it more easily. I placed the dock and frame structure in the water first, then ran the wiring thru the office portion.”

We have to say the night photos of this boat dock are absolutely stunning. Check out Joe’s blog for more great photos of his work and his layout.

[View the full thread on the MRH website](#)



[REGISTER](#)
(free)

[INDEX](#)

[TABLE OF CONTENTS](#)



Write for MRH / Running Extra!

WE'RE LOOKING FOR
ARTICLES, SO WRITE-UP
WHAT YOU'VE DONE, AND
SEND IT IN !

*How to write
for us*



**Lasercut structures. Highway,
storefront and billboard signs.**

**Neat ag customer for your railroad:
Farmers Fertilizer Supply**



Established 1993...

Blair Line



SINCE **1968**

THE CLOSEOUT KINGS!

PRE-ORDER POWERHOUSE!



TRAINWORLD.COM

orders@trainworld.com 1-800-541-7010

[f](#) [i](#) [x](#) [v](#) [p](#)

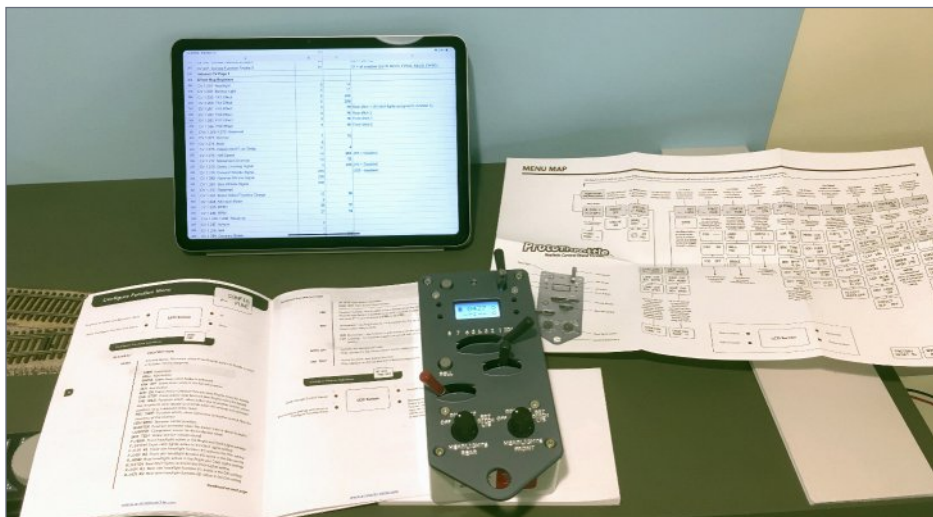

2. MRH forum member **Ken Rice** has a fascinating thread about how he's programming his decoders to get the best possible performance with his ProtoThrottle.

ProtoThrottle adventures

MRH forum member **Ken Rice** has been giving us his blow-by-blow efforts to configure his LokSound and Soundtraxx decoders to work well with his new ProtoThrottle.

Ken says, "LokSound recently added load sensitive features. After reading the ESU doc, I suspect it's possible to set up a LokSound decoder so you can operate the ProtoThrottle like a prototype engineer, and have the loco respond speedwise depending on load. There may be a possible hack to get a crude version of that with Soundtraxx too ..."

If you'd like to follow along, check out the full thread on the MRH forum for learnings. Exciting new insights await!

[View the full thread on the MRH website](#)



REGISTER
(free)

[INDEX](#)

[TABLE OF CONTENTS](#)

Recent photo fun thread

These images posted on a recent *MRH* forum Photo Fun thread show some great modeling of the prototype.

[View list of recent Photo Fun threads](#)

3. *MRH* forum member **Dom Bourgeois** posted this model photo showing a Delaware & Hudson Alco RS-3 number 4085 performing local work in front of the iconic Cobleskill Coal Company building.



4. Folks asked **Dom** about the somewhat unique Cobbleskill Coal Company building and he confirmed it still stands. In fact, he posted a YouTube video showing a Toys For Tots special excursion train rolling by recently. You can watch the video on YouTube and see that yes indeed, this eclectic structure still exists!



Get more articles like this

GIVE IT A **LIKE**



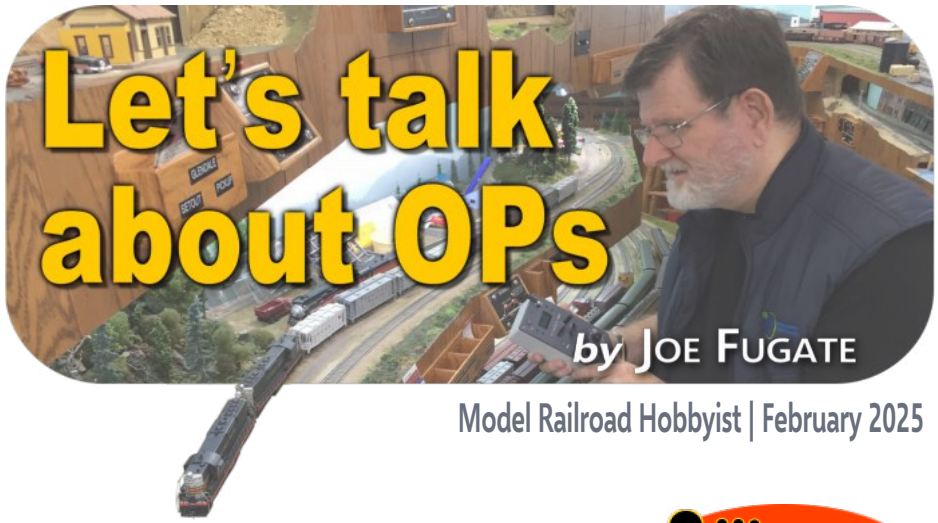

Let's talk about OPs

by JOE FUGATE

Model Railroad Hobbyist | February 2025

Getting started with realistic ops: determining what trains to run, part 3



IN DETERMINING WHAT TRAINS TO RUN ON MY SISKIYOU LINE LAYOUT, I was able to “cheat” and do more or less what the prototype did. If you are freelancing, you should pick a favorite prototype or two and study what trains they ran to get an idea of what trains you could run.

On the real Siskiyou Line, empty cars went south (railroad WEST) to the lumber mills, and cars loaded with lumber came north (railroad EAST). From this point forward, we will use the railroad directions in our discussion. The major yards on the Siskiyou Line from railroad East to West are:

- Eugene
- Roseburg
- Medford

The prototype ran two major through trains between Eugene and Medford called, appropriately enough, the Siskiyou Line West (Eugene to Medford) and the Siskiyou Line East (Medford to Eugene).

The prototype also ran two through trains between Eugene and Roseburg called the Seagull West (Eugene to Roseburg) and the

LET'S TALK ABOUT OPS | 2

1. The Coos Bay Hauler ran between Eugene and Coos Bay on my Siskiyou Line 1 layout coast branch. Roseburg was a major mid-point of the run and the train often swapped a block of cars in/out of Roseburg yard as part of its run.



Seagull East (Roseburg to Eugene).

Since my layout also included a proto-freelanced version of the Coos Bay coast branch that connected in at Roseburg, Oregon, we also ran two through trains between Eugene and Coos Bay yard on the Oregon coast.

The prototype called these Eugene – Coos Bay trains “Coos Bay Haulers,” with a hauler being the SP’s term for a slow-running heavy through train. No hurry – it will get there eventually.

Roseburg yard was the main yard on my layout, so let’s next look at the local trains that ran out of Roseburg yard. ☑



2. The area modeled box shows the route in the real world my Siskiyou Line layout covers.

Get more articles like this

GIVE IT A LIKE





WHAT'S NEW on TMTV!



Ultra-realistic deciduous trees

BACKSHOP CLINIC

Super-detailed deciduous trees



STEVE DAVIS' Kansas City Southern

COMING SOON!

Coming soon: Steve Davis' Kansas City Southern

Become a member ▶



Brought to you by



REGISTER
(free)

INDEX

TABLE OF CONTENTS

WHAT'S NEAT

column



Model Railroad Hobbyist | February 2025

KEN PATTERSON COVERS THIS

MONTH:

- **BLI** LOCOMOTIVES PULLING A 157-FOOT TRAIN
- MODELING IDEAS FROM ABOVE WITH **DAN SCHEIDELL**
- **JOEY GIUNTO** INTERVIEWS **SAM SYZDEK**
- NEW PRODUCTS WITH **BACHMANN'S TYLER HANEY**



WHAT'S NEAT with Ken Patterson
Sam Syzdek's amazing layout!

click to play video

PHOTOS AND VIDEO OF SUPERB MODELS

THIS MONTH, Ken follows up last month's segment on the new BLI diecast SD70ACe locomotives by showing them combined with two more BLI locomotives to pull a very long train. Dan Scheidell's Modeling Ideas from Above feature big UP power in Utah's Echo Canyon region, Joey Guinto interviews noted modeler Sam Syzdek, and Tyler Haney visits via Skype to show off the newest products from Bachmann.

BLI locomotives pulling a 157-foot train



1. For the 300th episode of "What's Neat this Week" (youtu.be/6Y9NUuyTuGg?si=2GJTQoz3VOTPAm9-), Ken and the crew had a 300-car train running around the basement, powered by the two diecast metal BLI SD70ACe locomotives, as well as the BLI GP30 and BLI GP35 seen here.



REGISTER
(free)

[INDEX](#)

[TABLE OF CONTENTS](#)



2. Before pulling the train off the layout and reclaiming his mainline, Ken put a total of 320 cars on his layout, without enough room left between the last car and the front locomotive to put in a bobber caboose. His mainline track length in the basement is 157 feet. Watch the video to see how well it runs. Info: www.broadway-limited.com

Modeling ideas from Above with Dan Scheidell



3. Dan records video of the Union Pacific in Echo Canyon, Utah. Ken was quite taken by this scene of an abandoned tunnel next to a train going through the cut that replaced it.



4. Echo Canyon, where the UP mainline parallels I-80 between Wyoming and Utah, contains scenery that is both colorful and dramatic.

Info: www.youtube.com/@TheRailfanDan

Joey Giunto interviews modeler Sam Syzdek



5. Joey Giunto visits Sam Syzdek, who has a heavily scenicked HO scale layout in a 16 x 24-foot room that is built into the back of his two-car garage.



REGISTER
(free)

[INDEX](#)

[TABLE OF CONTENTS](#)



6. Much of the layout features urban scenery loosely based in the 1950s and '60s. He's run out of room to add new buildings without removing any of the existing ones, so Sam has been building a lot of dioramas.

Did you see this article?

in the **FEBRUARY 2025 MRH RUNNING EXTRA!**



Jim Six: Making rolling stock choices

Get full eBook now ▶

click here



RUNNING
EXTRA

Each eBook has 80-100 pages





7. The backdrop mountains are constructed of paper towels dipped in Hydrocal draped over a framework. Sam's wife enjoys painting the mountain scenery and Sam's mother-in-law assisted with building the trestle, which is the only part of his last layout that made the 450-mile move from the Houston, TX area up to Arkansas.



8. Sam's structures are a combination of kits, kitbashes, and scratchbuilt structures. He especially enjoys building Hydrocal structures.



REGISTER
(free)

[INDEX](#)

[TABLE OF CONTENTS](#)



9. Sam received an special honor from structure manufacturer Downtown Deco – a model named after him, Syzdek Manufacturing.

For more on Sam's layout, see Campbell Rice's interview with him for the June 2019 "What's Neat:" youtu.be/nhdleie_vtM?si=PDLttku7dQIHh_I2

Did you see this article?

in the **FEBRUARY 2025 MRH RUNNING EXTRA!**



Model a Boston & Albany 36' boxcar

Get full eBook now ▶

click here



RUNNING
EXTRA

Each eBook has 80-100 pages





11. Tyler had pre-production samples of the HO scale Amtrak Midwest Venture cars to show off. The coach and business cars are semi-permanently coupled as a married pair on the prototype, but Bachmann has designed them as separate cars. Replacement couplers to mimic the semi-permanent couplers are included with the cars, which also allows them to be close-coupled.



12. In N scale, engineering samples of the Venture cars were shown by Tyler. Anticipated to ship in 2025, they share the same details as the HO scale cars, including interiors and working marker lights. Both Amtrak Midwest and Via Rail Canada versions are in progress.



13. N scale SD40-2 locomotives are shipping now to dealers, with Econami DCC/sound decoders installed at the factory.



14. Finally in N scale, the Pennsylvania Railroad's Fleet of Modernism paint scheme is now available on passenger cars. Designed by Raymond Lowey, the paint scheme was in use in the 1930s and 1940s.



REGISTER
(free)

[INDEX](#)

[TABLE OF CONTENTS](#)

From first train set to railroad empire...

*Our complete line of DCC products
grows with you. Discover the fun!*

- Designed and manufactured in the U.S.A.
- Preferred for ease of use and ergonomic design
- Unlimited scalability for any size model railroad
- Plug-and-play means more time running trains
- Great customer service and excellent support



See your dealer



REGISTER
(free)

[INDEX](#)

[TABLE OF CONTENTS](#)



Visit our new and improved web site for all your DCC needs!

- Get the latest new product announcements
- Watch our detailed how-to videos
- Browse the all-new Information Station
- Enjoy secure online sales, day or night!

Visit **ncedcc.com**



RailProTM**NEW****RE RING**TM
ENGINEERING

HC-3 and HC-3-SUN

Now with Four Real Buttons (Customizable) and Soft Grip Knob for the Ultimate in Train Control!
+ Much More!!!



- Lanyard Eye Ring
 - Significantly Smaller Size**
 - Significantly Lighter Weight**
 - 2x Storage Memory**
 - Better Battery Retention when Powered Off**
 - Compatible with all Older RailPro Products!
- ** When Compared to Model HC-2

US Patents 8,807,487
and 10,780,362
Copyright © 2024

GET THE DETAILS ►



REGISTER
(free)

[INDEX](#)

[TABLE OF CONTENTS](#)

Distinguish up to 27 buttons on one Arduino input

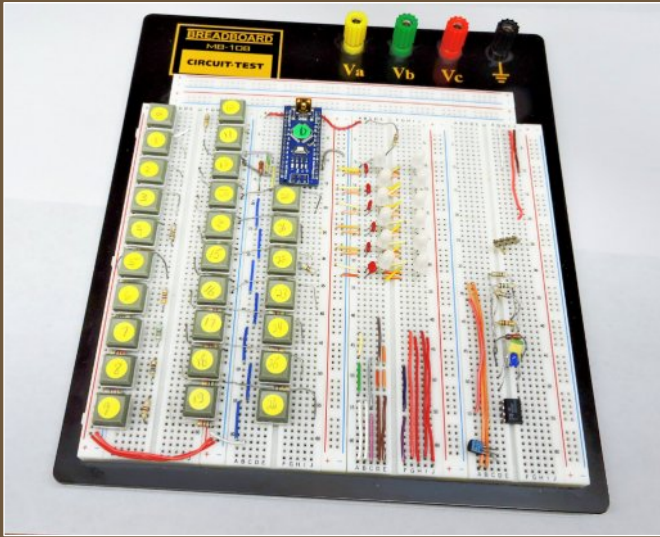

Electrical Impulses

1. I used the approach in this article to hang 27 buttons (0-26) off a single analog input to an Arduino Nano shown in this circuit mockup. Each button controls a unique combination of LEDs, demonstrating this trick can be used to get unique button control for lots of buttons yet use only a single analog input.

Model Railroad Hobbyist | February 2025



BLAIR SMITH ADDS MULTIPLE UNIQUE BUTTONS TO A SINGLE ARDUINO ANALOG INPUT ...

MANY ARDUINO APPLICATIONS FOR MODEL RAILROADS NEED LOTS OF BUTTON inputs.

Traditional button wiring with one high/low digital-button-per-input quickly consumes the available pins.

One trick using a five-row by five-column “button matrix” provides more buttons, consuming in this case just 10 pins for 25 buttons.

It seemed that using a single analog input and resistors to distinguish one button from the rest ought to do even better, but the solutions I found on the web using this technique were not satisfactory. Yes, a few buttons were easily distinguished on a single analog input, but I found no solutions going beyond about six buttons.

After contemplating this situation for a while, it suddenly hit me: all the solutions I had found all used identical resistors in series, or in series/parallel arrangements.

Perhaps using a different resistor value for each button might get better results. To keep things simple, my drawing [1] and description in this article show how a three-button implementation works, but I have used this approach for up to 27 buttons on a single Arduino analog input.

I’m assuming you know something about using an Arduino – if you don’t, then use the *MRH* index at mrhmag.com/magazine/toc-index to search for Arduino how-to’s. Or search in Google for Arduino tutorials, tons of great tutorials exist.

THE CIRCUIT

Note the dashed dividing line in [2]. The left-hand side of the circuit may be located remotely from the right-hand side and still function well. This allows a two-wire cable to extend from a multi-button panel to the Arduino analog input pin.

HOW IT WORKS

When no button is pressed, RP acts as a pullup resistor, charging capacitor C1. The normal input signal is therefore 5





Upgrade Your Layout!

CS-105

DCC Command Station

\$529.95 MSRP



- 5-Amp WiFi DCC system
- Supports: NCE and LENZ throttles
- Works with Digitrax throttles
(adapter sold separately)
- JMRI compatible
- TCS WiFi = Reliability, Speed, & Range

**Bundle
& Savé**





Southern Digital

WWW.SODIGI.COM

Celebrating 28 Years serving you

Some of the New Items from Digitrax



Zephyr Express
List \$245, Your Price \$196



Evolution Express Duplex Radio
List \$655, Your Price \$524



Evolution Express
List \$470, Your Price \$376



DT602D Radio Throttle
List \$270
Your Price \$216



UT6D Radio Utility Throttle
List \$180
Your Price \$144



DT602 Super Throttle
List \$200
Your Price \$160



UT6 Utility Throttle
List \$115
Your Price \$92



UR93 Duplex Receiver
List \$130
Your Price \$104



BD4N Block Detector
List \$37
Your Price \$29.60



BXPA1 Auto Reverser
List \$49
Your Price \$39



**Ni-MH Battery for
DT602 or UT6**
List \$13
Your Price \$10.40

DCC Conversions, Service & Support

E-mail: sales@sodigi.com (770) 929-1888



REGISTER
(free)

[INDEX](#)

[TABLE OF CONTENTS](#)

DISTINGUISH 27 BUTTONS ON ONE ARDUINO INPUT | 3

volts when no button is pressed. Since we power RP from the 5V pin of the Arduino, when the Arduino reads the analog input, the analog-to-digital converter (ADC) will see a voltage that is the same as its reference voltage.

Under those conditions, the ADC returns 1,023 counts, or full range. We get the 1,023 value because the ADC is a 10-bit converter, and 2^{10} gives us 1,024 values. Zero is one of those values, so we must count it too; hence the values range from 0 to 1,023.

When you press button B1, the result is obvious – because R1 is 0 ohms, so the circuit quickly discharges the capacitor to 0V, and that is what the ADC will read: zero.

When you press button B2, the result is different. The pullup resistor, RP, and the button series resistor, R2, form a voltage divider, and the voltage that results is $R2/(R2+Rp)$, or $(82/2282) \times 5V$, or around 0.180 volts. The ADC converts this voltage to around 34 counts.

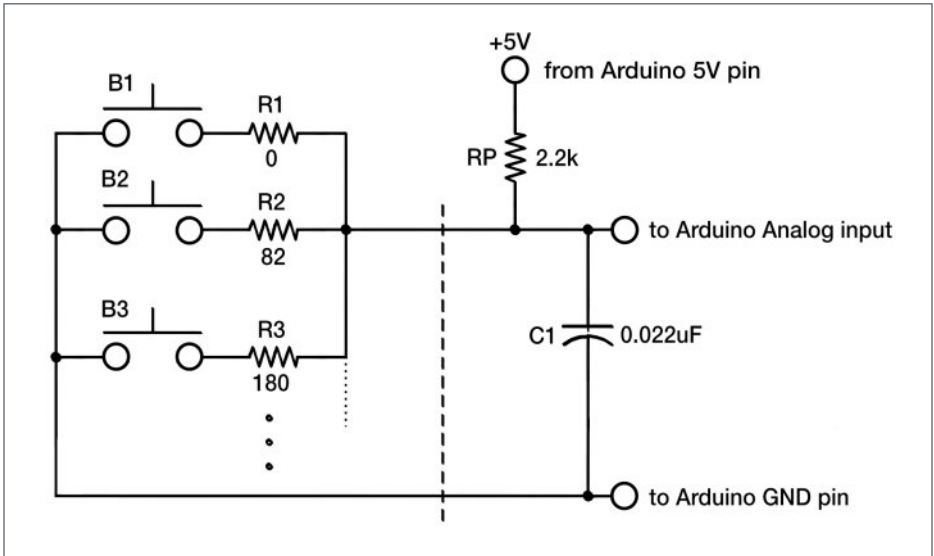

2. My example circuit. While I show only three buttons here (B1, B2, B3), I have successfully added another 24 buttons past B3, each with their own unique resistor value.

It is “around,” because resistors with a gold tolerance band can vary in value by about 5%. So the voltage produced when a button is pressed can likewise vary by up to plus or minus 5%.

Similarly, pressing B3 results in 0.378V, or 74 counts. As you can see, the individual button values can be easily distinguished.

The same formula holds true as we increase the resistor value associated with other buttons we care to add.

THE SOFTWARE

I’m using an Arduino Nano Classic as the processor in my example circuit [1]. If you’re using an Arduino Uno, just make sure to use an analog pin. Other Arduino products might require some more extensive revisions, as there are other hardware aspects to consider.

I will work with interested readers to resolve any such problems, but I also recommend the Arduino Forum, where such questions will likely receive additional helpful attention.

A bonus extras download Zip file [mrhmag.com/magazine/mrh2025-02/bonus-extras] contains three folders. Place the **ASButtons** folder in your Arduino IDE’s libraries folder. The two other folders contain **.ino** files and should be placed where your sketches normally go. I have a folder named Projects for all my sketches.

I provide two Arduino sketches, as well as a rudimentary class library. The first sketch is used to *characterize* the button network one has created, while the second one is used to *demonstrate* an example application of the button-read function itself (using the **ASButtons** library component).

You use output from the first sketch to update the second sketch code, so you must run them in the proper order: First run **CharacterizeASButtons.ino**, then copy the output and update the code in **DemoASButtons.ino**, and then run that.



STREAMLINED BACKSHOP

Your Virtual LCC & DCC Superstore!

SBS4DCC.COM



The screenshot shows the Streamlined Backshop website interface. At the top, there's a navigation bar with links like HOME, SHOP BY DECODER INTERFACE, PRODUCTS & SERVICES, DEC TIPS, MORE INFO, CONTACT US FORM, BLOG, and DELAYED SHIPPING NOTICE. A search bar and utility icons (Wish Lists, Gift Certificates, Recently Viewed) are also present. The main content area features a 'DELAYED SHIPPING NOTICE' banner and a 'WELCOME TO Streamlined Backshop... Your Virtual LCC & DCC Superstore!' message. The featured product is the 'NixTrainz Power Bridge', described as a 'Cost Effective Lok-compatible Stay-Alive!' with a 'SHOP NOW' button. A detailed product image shows the bridge on a coin, with text: 'NixTrainz Power Bridge for LokPilot & LokSound', 'Great Products for Professional Installations', and 'A cost effective solution for powering Lok's through tough trackwork!'. A sidebar on the left lists various product categories like 'New Products', 'OpSIG Books', 'SBS4DCC Products', etc.

CHECK IT OUT ▶

Great control in a tiny package



**Original
Touch Toggles**

- Touch Toggle™ plug in controls
- Bright clear indication
- Easy setup
- Flexible system

Stall Motors, Twin-coils,
Power, and Servos

Now for Tam Valley Depot
and MRservo too!



Made in the USA 

What will they think of next?

www.berretthillshop.com



ESU

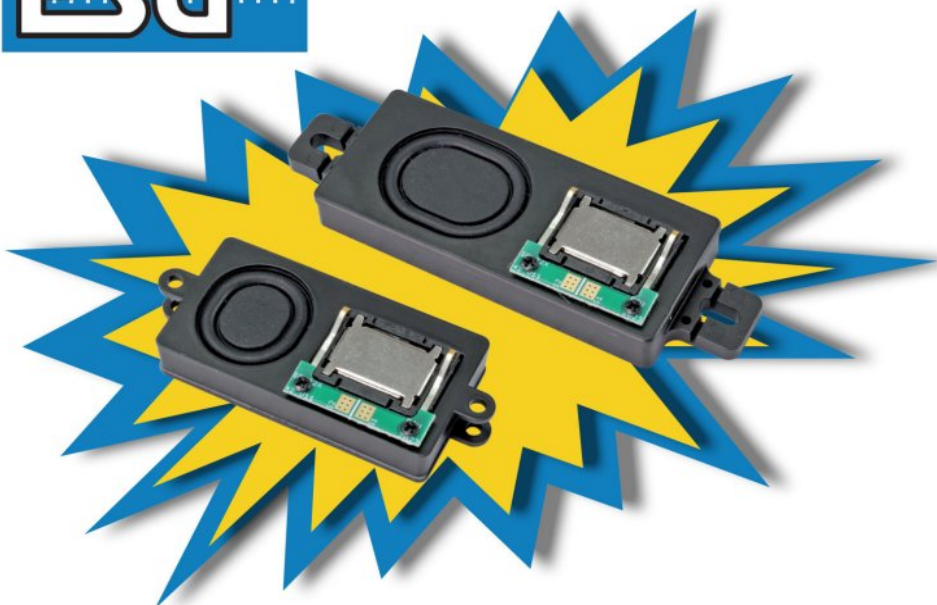

The New Standard

The **ULTIMATE** in realism with enhanced sound clarity

Art.-No. 50345 - Loudspeaker

22mm x 42mm x 8.0mm

\$17.99 (MSRP)

Art.-No. 50344 - Loudspeaker

24mm x 55mm x 8.6mm

\$17.99 (MSRP)

www.loksound.com



REGISTER
(free)

[INDEX](#)

[TABLE OF CONTENTS](#)

CharacterizeASButtons.ino: The purpose of this sketch is to develop an array of threshold values used to identify buttons in the **DemoASButtons.ino** sketch.

To use this sketch, open this ino file in the IDE, open the Serial Monitor, ensure the Serial Monitor baud rate is the same as that which is set in the sketch (115200), then upload the *characterize* code to your Arduino.

Once uploaded, follow the prompts, pressing the buttons as instructed until you are done. Note that you must press the buttons in increasing resistance order, so start with the button attached with 0 ohms, then 82, then 180, and so on.

When you stop pressing buttons, the code will time-out and then present a table of results like the following (this is for the schematic in [2]):

```
//Resistance:    0      82    180
//Button #:      0,     1,     2
//Readings:      0,    34,    75
//Deltas:        34,    41
//Thresholds:    17,    54,    91
//For code:
uint16_t Tvals[] = {17, 54, 91};
```

You only need the last line below the “**For code:**” comment, which must be copied and pasted into the appropriate spot in **DemoASButtons.ino**, which is the second sketch.

DemoASButtons.ino: The sketch demonstrates using the analog button string library. After opening this sketch in the IDE and pasting in the results copied from the Serial Monitor above, compile and upload this sketch to your Arduino.

How this sketch works: If you have wired up the example circuit, you will have three buttons. The threshold array in the

code shows that for an Arduino analog ADC count less than 17, the read function returns a 0-index position in the array, for a count between 17 and 53, it returns a 1 position in the array, and for a count between 54 and 90, it returns a 2 position in the array. Any value 91 or above will be presumed to be “no button pressed” since we only have three buttons in the circuit.

The **switch...case** structure in the code shows how to use the value returned to perform different actions on the layout.

Here is the main body code of this sketch so you can see what I’m describing. The red code are the items I have referred to above.

```
#include "ASButton.h"
//between these two lines paste as much of the output from Characterize as you need, but be
//sure to include the last line, beginning "uint16_t Tvals[]=
//-----
uint16_t Tvals[] = {17, 54, 91}; //Copied from CharacterizeASButtons.ino output
//-----

ASButton Buttons(A7); // Instantiate ASButton to use analog pin 7

void setup() {
  Buttons.begin(sizeof(Tvals)/sizeof(Tvals[0]), Tvals);
  Serial.begin(115200);
  Serial.println("Demo/test of using the GetASButton function; press buttons to test:");
}
```



TamValleyDepot.com

BlueRailDCC
Next Generation
DeadRail System

Use the "Blunami" App from
BlueRail to control your DCC
locomotive decoder

True 2-way Bluetooth Radio
Read/write CVs
Monitor battery voltage

Available in 2A and 5A
HO to G



[Click for User Guide at BlueRail](#)

[Click to Order at TVD](#)



SQUEALER
Motion Activated Flange Squeal System

Sshhhhhhttttt!!

Experience a **revolution** in
trackside sound!



Iowa Scaled Engineering
iascaled.com

Make LocoNet wiring extremely simple!

ACCU-LITES, inc

Your DCC Center!



**Suitcases belong in your baggage
cars, not under your layout!**

Check out the DCC Vampire II ...

This guy does the job of two suitcase connectors!

And really holds the connection good too!

CLICK NOW TO DISCOVER THE AMAZING VALUE!



Dealer Inquiries Accepted



from the
**Model Railroad
Hobbyist** *Store*

Running time:
3 hrs 53 min

TRAINMASTERS.TV'S



HO DCC

Install examples

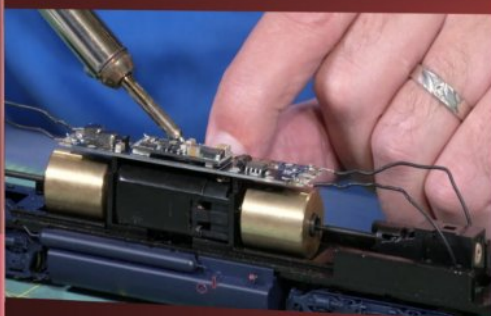

Follow these step-by-step DCC installs

▶ Includes JMRI DecoderPro tutorial



Download

~~\$24.99~~

\$19.99

DVD

~~\$45.00~~

\$31.77



Download NOW

Get Video
Download

DVDs: FREE SHIPPING US
50% OFF SHIPPING FOREIGN

Order the
DVD Set



REGISTER
(free)

[INDEX](#)

[TABLE OF CONTENTS](#)

```
void loop() {  
  int16_t response = Buttons.read(); //call the function and get array index position to  
                                     // indicate button nbr pressed (0,1,2, ... etc.)  
  if (-1 != response) {               //if a button was pressed  
    switch (response) {               //act on it  
      case 0:  
        Serial.println(" Button 0 pressed. Do something like throw turnout 1");  
        break;  
      case 1:  
        Serial.println(" Button 1 pressed. Do something like reverse turnout 1");  
        break;  
      case 2:  
        Serial.println(" Button 2 pressed. Do something like throw turnout 2");  
        break;  
      default: //this is where switch ends up, if the input value has no case assigned  
        Serial.print("No action for this return value. ");  
        Serial.print(response);  
        Serial.println(" Maybe we missed something?");  
        break;  
    }  
  }  
}
```

Do ALL your model railroading friends know about MRH?

WE CONTINUE TO BE SURPRISED BY HOW MANY MODELERS STILL HAVE NEVER HEARD OF US - SO SPREAD THE GOOD WORD ABOUT MRH!

ASButtons Library: This is a code library that I wrote to do the button string reading magic. Without getting into all the technical details, suffice it to say this decodes each button's press using the ADC analog reading features of the Arduino and returns a value: the button number you pressed.

You take this number in your code and do what you want to do for each given button press. I demonstrate the use of this library in **DemoASButtons.ino**.

If you're a more advanced Arduino user and feel confident enough to explore more advanced uses of this library in your Arduino code, see the side note *Doing more with the ASButtons Library*.

TECHNIQUE LIMITATIONS

The primary limitation with this method is we have no easy way to determine if multiple simultaneous buttons are being pressed. Doing so will yield a 'ghost' button press farther down the chain.

That means this button-reading technique is best suited to single-operator panels, or low-use multiple panels where operators are unlikely to press buttons simultaneously. If one must have multiple panels, for example three small panels serving three industries, it would be better to use one of these circuits for each panel.

Wire length for the button string may become an issue in extremes, although it has been tested successfully at greater than 10' on my DCC layout.

APPLICATIONS

Probably the two most common applications of this technique would be for turnout operation in a yard panel, and on a selector panel for turntable operation, allowing a button-per-track selection to be made.



RESISTANCES USED

The table in [3] shows the resistor values I have used.

If you use these resistors, the default threshold set in the **DemoASButtons.ino** code should be adequate. But if you need say only 20 buttons, simply drop the remainder of the thresholds from the table, keeping only the first 20, and use the lowest 20 resistors.

3. In my 27-button example [1], here are the resistor values I have used.



Button	Ohms
1	0
2	82
3	180
4	270
5	360
6	470
7	620
8	750
9	910
10	1.1k
11	1.3k
12	1.5k
13	1.8k
14	2.2k
15	2.7k
16	3.3k
17	3.9k
18	4.7k
19	5.6k
20	6.8k
21	8.2k
22	10k
23	13k
24	18k
25	27k
26	47k
27	150k

Did you see this article?

in the FEBRUARY 2025 MRH RUNNING EXTRA!

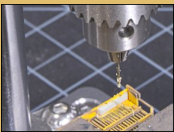

An affordable precision micro drillpress

Get full eBook now ▶

← click here



Each eBook has 80-100 pages
MRH RUNNING
 ##### EXTRA

ABOUT MY PROTOTYPE

The breadboard I did shows 27 buttons. All work without issues. For my layout control panels, I have a maximum of 23 buttons in use.

But working with this prototype, it is evident that 27 are doable on a single Arduino analog input pin.

Get more articles like this

GIVE IT A LIKE

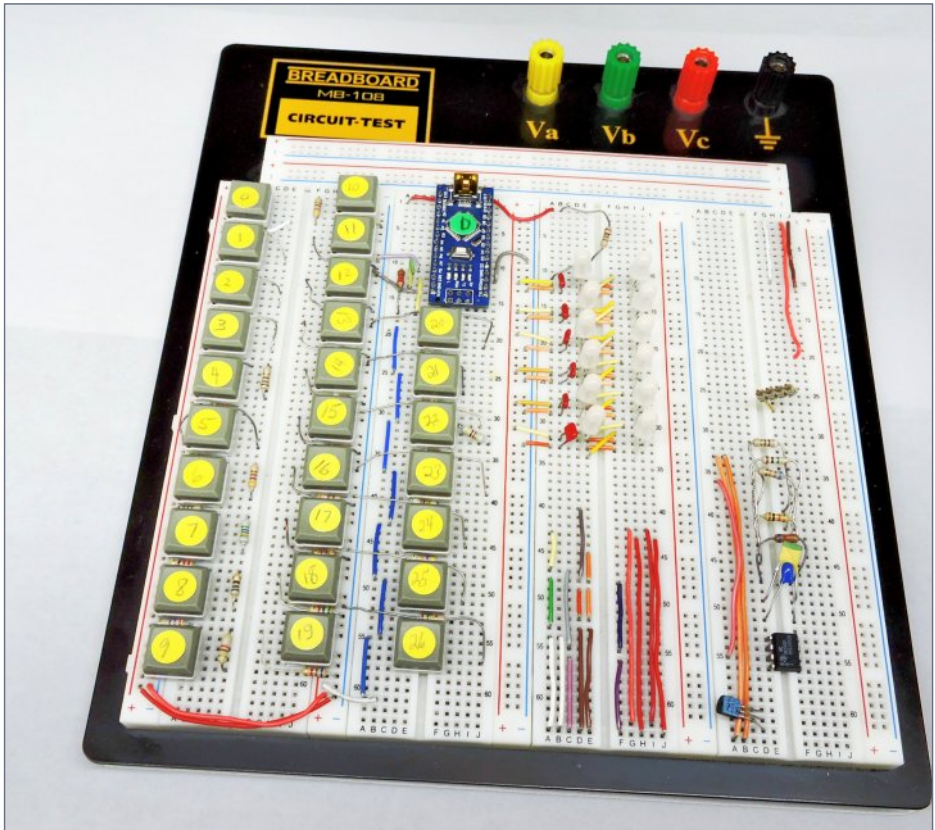

4. My example here successfully used 27 buttons.



REGISTER
(free)

[INDEX](#)

[TABLE OF CONTENTS](#)



B. Smith

DOING MORE WITH THE ASBUTTONS LIBRARY

For more advanced users, this library allows you to deploy more than one analog button string. You can use a different resistor array with each button string instance like this:

```
uint16_t Tvals1[] = {17, 54, 91, 125, 159, 201, 239, 273, 315, 356,
392, 434, 482, 532, 585, 631, 672, 712, 750, 790, 824, 855, 892,
930, 962, 992, 1021};
```

```
uint16_t Tvals2[] = {18, 52, 94, 128, 160, 200, 241, 272, 318, 357,
391, 436, 484, 533, 588, 633, 671, 715, 756, 797, 827, 856, 898,
933, 964, 998, 1023};
```

You instantiate a new ASButtons instance for each new button string that feeds a different analog pin. Use this code to instantiate a new button string reader for each analog pin:

```
ASButton ButtonString1(A1); // Button string 1 reader for analog
pin 1
```

```
ASButton ButtonString2(A2); // Button string 2 reader for analog
pin 2
```

Then in void setup(), you call the begin method for each button string like so:

```
ButtonString1.begin(sizeof(Tvals1)/sizeof(Tvals1[0]), Tvals1);
```

```
ButtonString2.begin(sizeof(Tvals2)/sizeof(Tvals2[0]), Tvals2);
```

Then in your void loop() code, you read each button string instance value and act on it like so:

```
int16_t response1 = ButtonString1.read();
if (-1 != response1) {           //if a string 1 button was pressed
    switch (response1) {         //act on it, etc
```

DOING MORE WITH THE ASBUTTONS LIBRARY CONTINUED ...

```
...
int16_t response2 = ButtonString2.read();
if (-1 != response2) {           //if a string 2 button was pressed
    switch (response2) {        //act on it, etc

```

...
You can easily invoke up to eight instances of the class using the eight analog inputs on a Nano. This might effectively provide you with >200 buttons!

If you're skilled enough that you are into editing the library code itself, you could extend it to incorporate features of many Arduino products (e.g., different ADC resolutions).

Another feature that could be added would be to incorporate long presses as a different return. For example, pressing button 16 for over 1 second might result in a different value returned, perhaps something like 16 + 25. ■

**Did you know
there's an MRH/
RE index
available?**

Click to find out more



REGISTER
(free)

[INDEX](#)

[TABLE OF CONTENTS](#)

BLAIR SMITH



Blair is a 64-year-old retiree from a career as an EE-tech (hardware/software/JOAT) supporting R&D/Operations in the CANDU nuclear industry. Blair and his wife, Rasa, canoe and camp across Canada, relax at their “other” place for the summer, then winter in the home they built in 2015. Blair designed

the home to house his dream layout, working on the layout through the winter months.

Blair started with the so-common train-around-the-tree, then moved on to O/HO/N train sets as a kid. He has had four layouts, two of which he would term “successful.” Blair likes to dabble in electronics and software/firmware, primarily using the Arduino as a building block. His latest project is a 16-servo node for controlling turnouts on his layout, of which this article describes one element – the multiple button input. This project is part of his multi-deck Algoma Central layout. ■

Get more articles like this

GIVE IT A **LIKE**



**Please tell your buddies
about MRH Magazine!**

Digit

Introducing the UT6 & for Digitrax Comp



- **Compact size for easy one-hand**
- **Color 1.5" LCD Screen**
- **Full numeric keys for easy Loc**
- **Fine speed control with a larg**
- **Removeable LocoNet® cord**
- **Forward/Reverse toggle switc**
- **Off/On switch, uses AA or BP6**

Find out more @ www.



REGISTER
(free)

[INDEX](#)

[TABLE OF CONTENTS](#)



UT6D Utility Throttles Complete Train Control!

Handed operation

UT6

Utility Throttle

\$105.00 MSRP

Automotive selection

UT6D

Duplex Utility Throttle

\$170.00 MSRP

Encoder knob

Hand with Braking

**View all features and *more*
on our website!**

100MH batteries

digitrax.com/throttles/

MRH MARKETPLACE



LOOK
at what's new at
Black Cat this month

Click here for
our website

**PGE 50' box car
decals with 2 different
map schemes .**



Black Cat Publishing
(204)489-5005
ajfergus@mymts.net
blackcatdecals.com

**Railfan season
starts SOON!**



**St. Louis Railroad
Prototype Modelers meet**

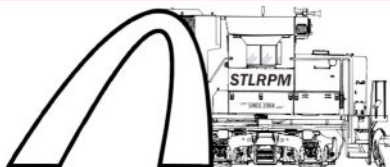

17th annual event
38,000+ sq ft
5,000+ models
200+ vendor tables
20+ historical societies

click here

Learn more ...



July 24 - 26, 2025

W GOLDEN AGE LINE
WESTERFIELD
MODELS, LLC

**NEW KIT: 11001 N&W
BATTLESHIP GON**



ALSO X23/R7 LADDERS
westernfieldmodels.com

Portable Office Trailer
..and yes there is an interior for it!



Kit# HO-7518
O-7518

www.interactionhobbies.com



REGISTER
(free)

[INDEX](#)

[TABLE OF CONTENTS](#)

NOBLE GAS & TUNGSTEN  **NEON SERIES**

1:87 - HO SCALE NEON SIGN KITS



LEARN MORE
 -ASTONISHINGLY REAL-
 -100+ NEON DESIGNS-
 -FREE TEMPLATES-

 @dvldesignllc  

Your ad could be in this space for just **\$58 a month.** Click to learn more ...

MONASHEE LASER ENGINEERING

COME VISIT US CLICK HERE 

MANUFACTURERS OF FINE RAILROAD STRUCTURES AND ROLLING STOCK MODEL KITS

Model Railroad Control Systems

Geoff Bunza Project Boards
 DCC Occupancy Detectors
 CMRInet Compatible Nodes
 Layout Telephone Systems
 RFID Switchlist Generator
 Switch Machines and Drivers



HOW REALISTIC ARE YOUR WHEELSETS?

To find out visit www.MasteristScaleRailroadModels.com 

- CUSTOM-BUILT WHEELSETS TO SUIT ANY PROTOTYPE
- PARTICIPATING IN HERITAGE PRESERVATION EFFORT
- MSRM FUNDRAISING MEMORABILIA
- MORE PROJECTS IN DEVELOPMENT

TRACKSIDE DETAILS & SCENERY PRODUCTS



NORTHWESTERN SCALE MODELS

WWW.NWSCALEMODELS.COM

PRECISION DESIGN CO.

CUSTOM DECALS FROM YOUR OWN ART IN JUST ONE DAY

PDC.CA

FULL COLOR & SOLID WHITE

click to learn more!

 **East Coast Circuits**
 Innovating Your Model Railroad Layout

P.O. Box 25412
 Providence, RI 02905

Lighting Circuits For Your Layout

Random Lighting Circuit - Burning Fire Circuit
 Traffic Light Circuit - Crossing Signal Circuit

Custom Lighted Vehicles
 HO & O Scale Emergency Vehicles
 HO & O Scale Trucks & Cars

Eastcoastcircuits.com Eastcoastcircuits@gmail.com

Great Decals!TM

FEC, Interstate, Virginian Railway, & L&N Titles
 After Hours Graphics Line
 Coupler Gages and More
 In O, S, HO, and N Scales





P.O. Box 6 Paonia, CO 81428

Ph. 970 527 4586

Made in The USA

Cast resin items for All Scales.

Tunnel portals, bridge piers, abutments, culverts, and retaining walls.

Trackside details and sage brush tree armatures.

"FREE SHIPPING see website for details"

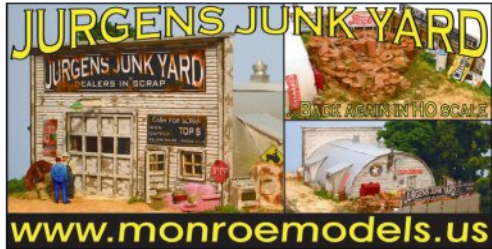

Light EFX-16



- On-layout lighting effects for 16 Just Plug® - compatible outputs; programmable via DCC or LCC
- >30 light effects such as blinking, pulsing, fire, fluorescent tube, traffic signals, photographer, welder, fusee, chase lights and more!
- Programmable brightness
- Trigger via on/off switch, DCC switch command, or LCC fast clock time

LOGIC RAIL™
TECHNOLOGIES

info@logicrailtech.com

(281) 251-5813



www.logicrailtech.com

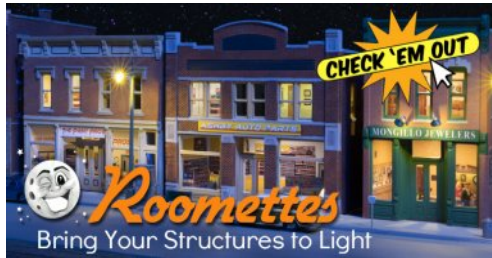

Andy Reichert's Proto-87 Web Pages.

A source of information and support for **the Real Proto-87 Standard** and for more Accurate and Realistic Model Track in general

www.proto87.com

WE'RE BEHIND YOU ALL THE WAY

Sceniking®.com
...nothing compares...
Click to learn why!

**Hobby Marketplace
Ads are Economical
and Effective.**

Click to learn more ...

DID YOU KNOW
MRH REGISTERED READERS
GET FREE BONUSES?

**CLICK TO REGISTER
NOW - IT'S FREE!**



REGISTER
(free)

[INDEX](#)

[TABLE OF CONTENTS](#)



Nicolo Platas' **NPSF revives rail service over the Raton Line**

**NICOLO PLATAS SHARES A PROTO-FREELANCE
RAILWAY ...**



REGISTER
(free)

[INDEX](#)

[TABLE OF CONTENTS](#)



1. The Los Angeles-bound Southwest Chief arrives at Lamy. Just as on the prototype, both Amtrak and New Mexico's Rail Runner Express serve the station.



Photos by Albert Matzelle

IT'S BEEN MORE THAN 114 YEARS SINCE THE

SANTA FE built the Belen Cutoff in 1908. The line rerouted freight traffic away from the steep three-percent grades of Raton onto the gentler grades of what is now BNSF's Transcon route.

Today, BNSF runs about 80-90 trains through the Belen Cutoff, but no longer uses the line from Albuquerque through Raton for freight. Only New Mexico's Rail Runner Express commuter service and one section of Amtrak's Southwest Chief in each direction per day use the line [1]. There are few trains, but a world of opportunity.

I've always been interested in modeling the Santa Fe, and I liked the idea of long trains running across wide open spaces with the look of the old Route 66 [2]. When my wife and I bought our home back in 1995, I got my chance. My dream of a large basement layout was to about to begin.

It was going to be a large layout, but I had a lot of help right from the start. With the help of model railroading friends, I spent a year designing a track plan to fill the basement [3, 4]. I knew I wanted an open and uncrowded look, and I wanted to ensure we kept open space for people to walk around without stepping on each other.

The NPSF (what started as "Nicolo Platas' Santa Fe" got shortened to just NPSF), is a double-deck layout, using a gradual slope rather than a helix to transition between the two levels. The lower level represents the industries from Rio Bravo, Albuquerque, and Hahn, NM. The prototype has numerous rail-served industries [3].





2. A new AC 44 Charger passes the landmark Mission Chapel of Our Lady of Light en-route to the Lamy station with the Southwest Chief. I've tried to recreate the feel of the area as much as possible.

**Click the ads
to help support
*Model Railroad Hobbyist!***

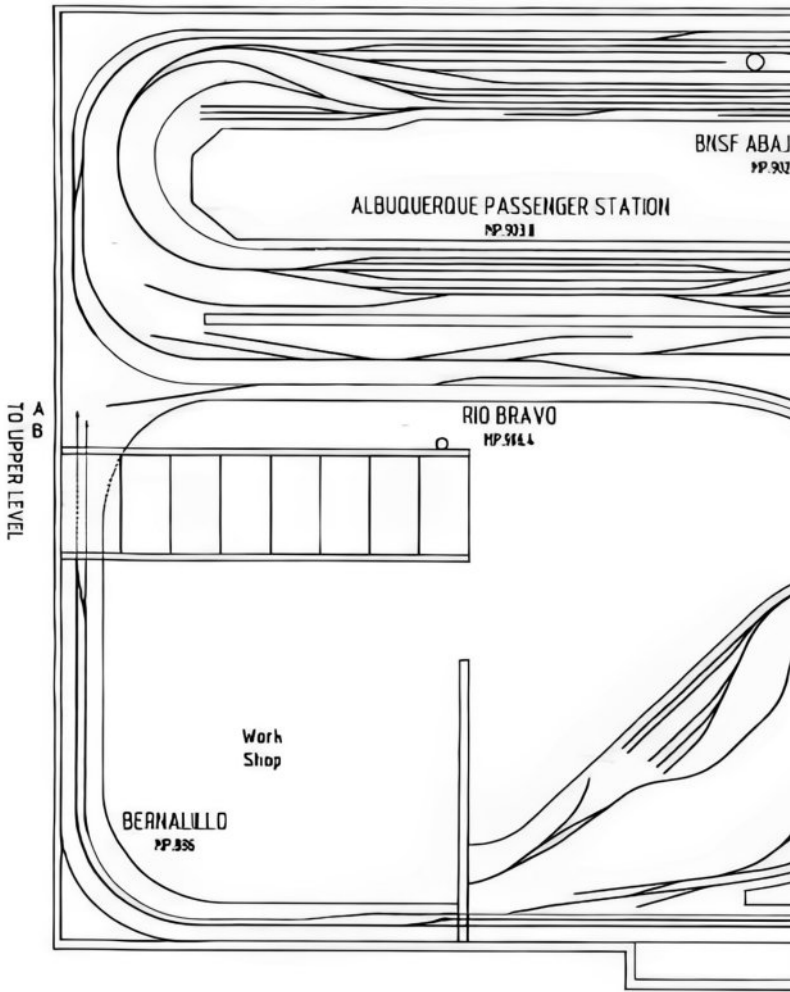

**LOWER LEVEL
TRACK DIAGRAM**

SCALE: 1/4"=1-0" DATE: 03/30/2014

NPS
Connection

3. The lower level of the NPSF represents the area from Belen (staging) to Bernalillo.



REGISTER
(free)

[INDEX](#)

[TABLE OF CONTENTS](#)

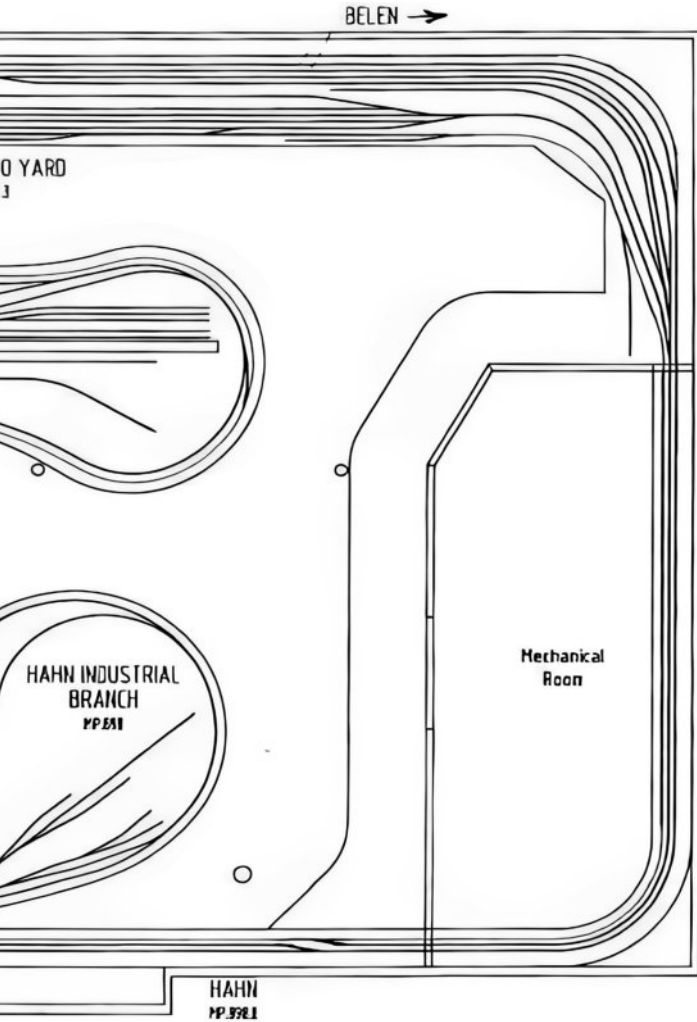

FRR
s to the Chief



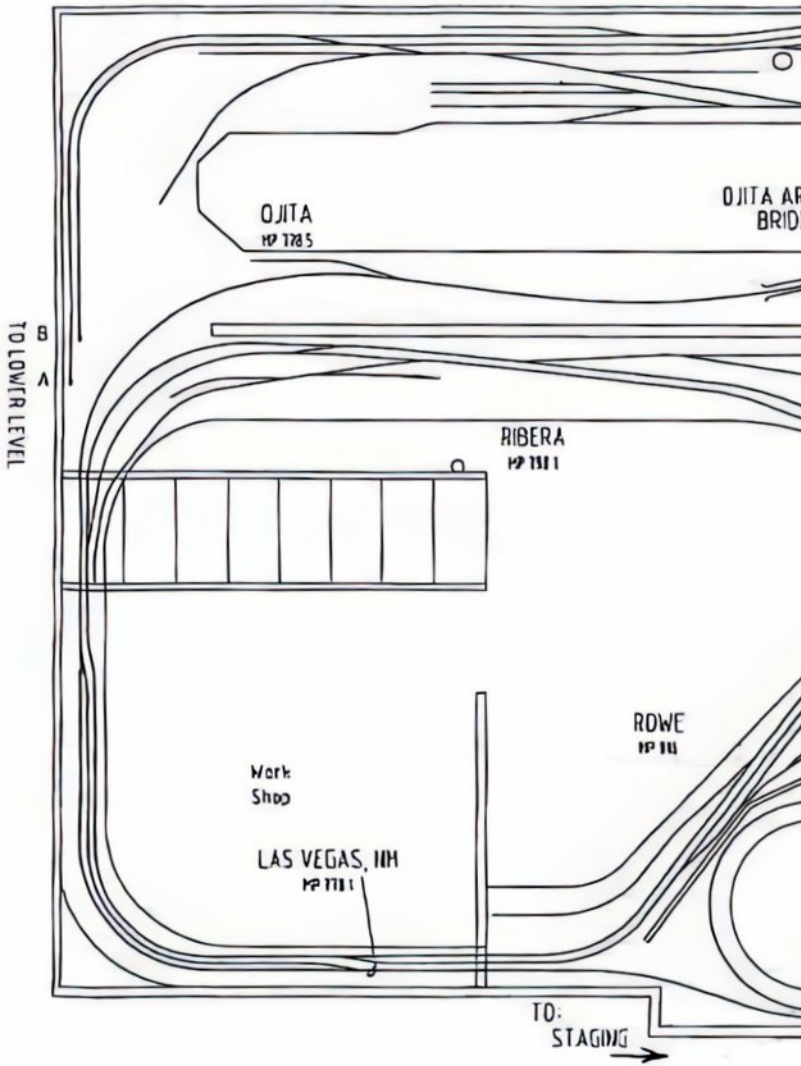

UPPER LEVEL TRACK DIAGRAM

SCALE: 1/4"=1-0" DATE: 12/29/2013

NPSF
Connections

4. The upper-level track plan for the NPSF.



REGISTER
(free)

[INDEX](#)

[TABLE OF CONTENTS](#)

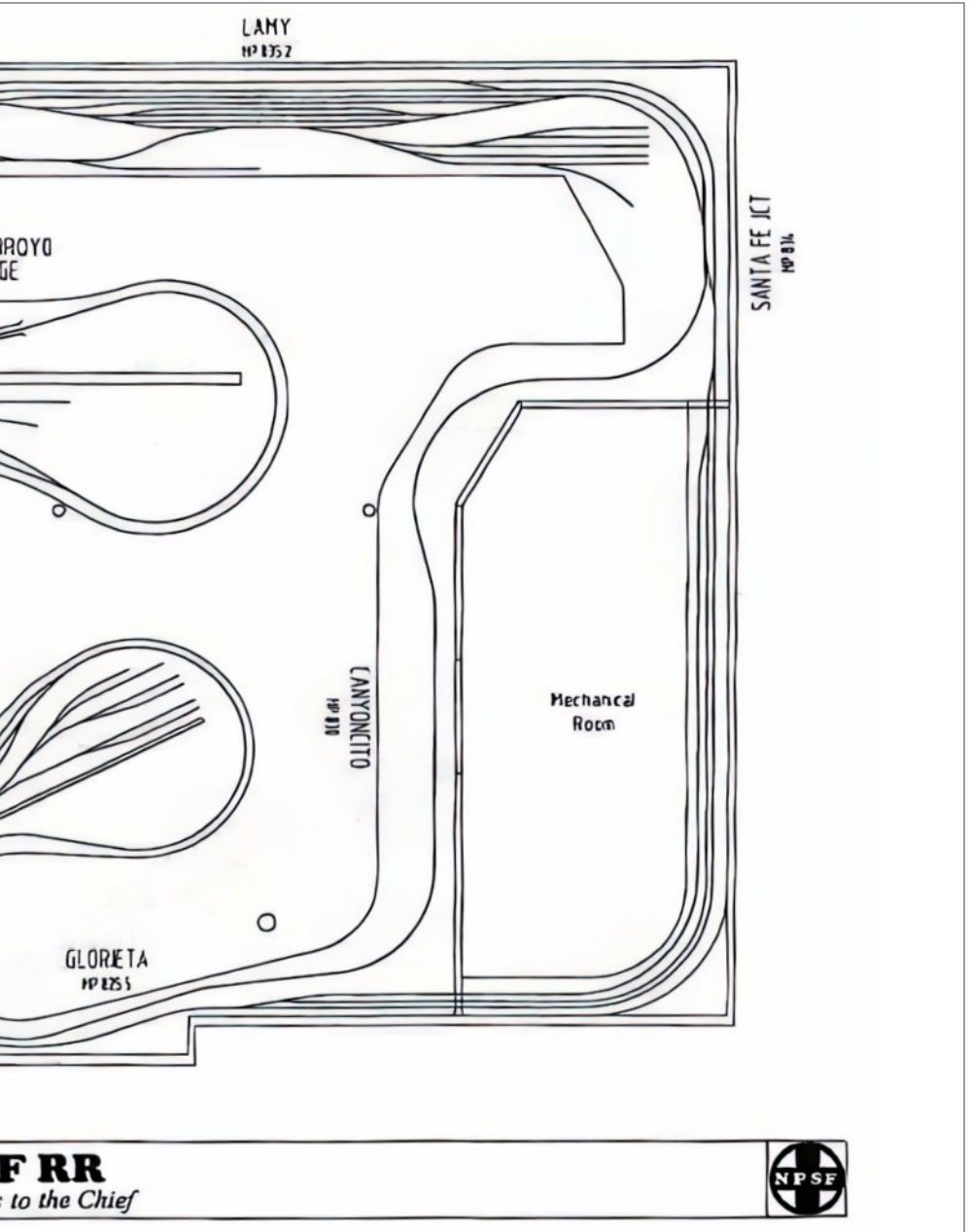

FRR
to the Chief



NPSF RA

Rail Runner service:

- Belen to Santa Fe
- Belen to Raton

Amtrak Southwest Chief serves:

- Belen
- Albuquerque
- Lamy
- Las Vegas, NM
- Raton

NPSF provides freight service to:

- Rio Bravo
- Albuquerque/ Abajo
- Hahn
- Lamy
- Santa Fe
- Rowe
- Ribera
- Ojita

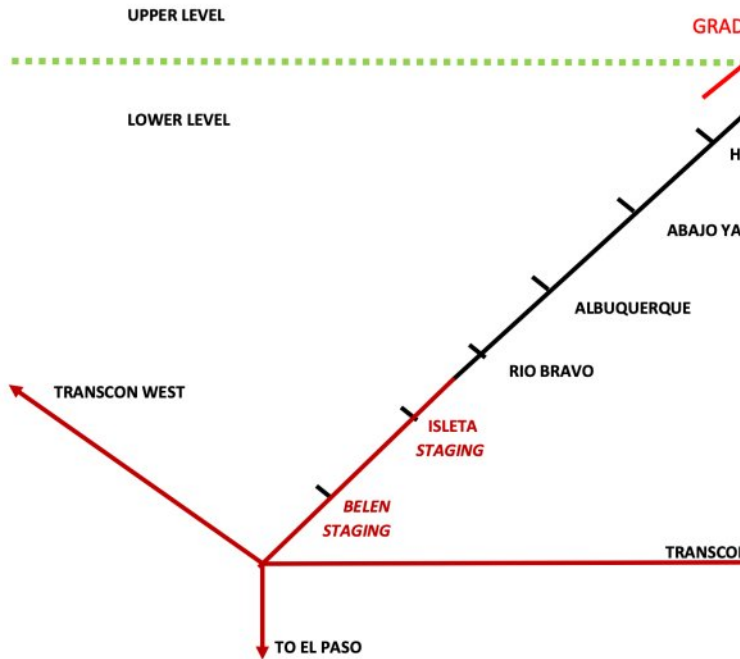

5. Route diagram for the NPSF.

RAILWAY

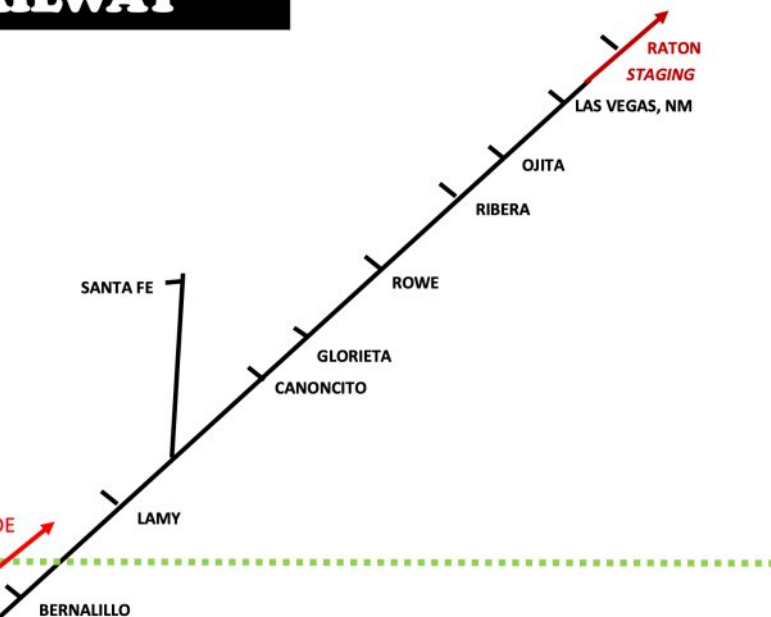

 [VIEW READER COMMENTS](#)



The upper deck runs from Lamy east to Raton (staging) [4]. There are no rail-served industries in this area on the prototype, but we took liberties here to add plausible industries. Some are real industries, but not in our modeled area, while others are truck-served industries that the NPSF has convinced to use rail service [4].

Layout (and house) construction began in early 1997. As the benchwork and trackwork came together, we realized our designs didn't provide a viable plan for operations, and our railroad needed a story. I wanted the Santa Fe, but as my friend Charlie said, we have about 900 square feet to work with, not a stadium. We needed to narrow our focus.

As construction moved on, I looked for small areas of the Santa Fe to model. But how do you cut out a piece of the Transcon and still have switching areas to keep people busy?

We researched railroads such as the Arizona and California and Montana Rail Link, and a story and scheme started to take shape. We looked for areas that could provide switching locations, a mainline that could still handle long trains, and a major yard. We decided that we would model the present, and our line would be an engine of economic development.

The Raton line in New Mexico offered everything I was looking for. The area north of Albuquerque had very few rail-served industries, and the Santa Fe Southern, a short line that worked the 18 miles north to Santa Fe, was hanging on by a shoestring. We decided to model the BNSF Raton Pass line from Rio Bravo to Las Vegas, with staging set at Belen and Raton [5].

As the concept developed, the layout's purpose came to life. Where a class-one railroad could no longer afford to serve the local customers, a short line can still turn a profit.

Because the area has no real rail business to speak of, we developed the story – and the industries – that give purpose to the NPSF. We took care in planning each location to make it believ-



able that industries either relocated along the line or were already there and wanted rail service.

The town of Lamy is a station stop for daily Amtrak trains, but has no other industries [1, 2]. But on the NPSF, we built a yard and the railroad's corporate office. The NPSF also operates a dinner train out of Lamy on weekends [6].

The NPSF investment in the town of Lamy has sparked additional business growth. A locomotive rebuilder has built a shop. This allows us to see locomotives from all different railroads waiting to be reconditioned [7].



6. The dinner train, seen here on its return to Lamy, runs through some beautiful desert scenery in areas such as Canoncito, Glorieta, and Ojita.



7. The locomotive shop just west of the Lamy yard repairs units from just about any railroad. A track mobile moves a freshly repaired lease unit to shipping. NPSF will deliver the unit to Albuquerque.



8. The Lamy Recycling Depot is one of several industries that help keep the NPSF in business.



REGISTER
(free)

[INDEX](#)

[TABLE OF CONTENTS](#)

Smurfit Stone has a warehouse that requests numerous box-cars. In addition, although the real Lamy recycling depot is only truck served, the layout's representation has picked up rail service and has expanded to handle construction debris from a building boom in the area [8].

THE ROWE ETHANOL PLANT

Heading north from Lamy, we come to the town of Rowe, which in real life has no industry. Due to the efforts of the NPSF's great sales department, a new ethanol plant located along the line, enticed by the promise of being rail-served with a dedicated service agreement [10]. This plant, based on the real one that is in the southeast part of the state, is the largest industry on the NPSF.

The rationale for the plant is that the ethanol company wanted to open another plant, and needed rail service. With the NPSF's connection to the BNSF just a short distance away, it made sense for them to open a new plant along the mainline.



9. The main shed at Lamy recycling was scratchbuilt.

The plant is switched every session. An NPSF crew leaves early in the morning from Lamy yard with buffer cars in tow. They arrive at the plant to pick up loads. After picking up a loaded train, they head to Albuquerque (Abajo Yard) to turn the train over to BNSF.

The crew picks up empties and heads back to drop off the empties at the plant to be loaded for pickup in the next day or so. The ethanol plant keeps crews busy for almost the entire operating session. The plant sees a constant movement from inbound empties and outbound loads of ethanol [10, 11].



REGISTER
(free)

[INDEX](#)

[TABLE OF CONTENTS](#)

There are also blocks of covered hoppers coming in with grain to feed the plant. Then empty grain cars come in to take away brewer's grain (the byproduct in the making of ethanol) which is shipped to feed plants [12].

The grain comes in on a BNSF train, usually from Raton, which is brought to Abajo Yard for the NPSF to pick up. The empty grain cars are brought down to the yard, and loaded ones are delivered to the plant. This train usually runs every other session.



10. B40-8W no. 846 and much older rebuilt U36C no. 3601 bring empty tank cars for the ethanol plant. NPSF's locomotive fleet consists primarily of second-hand power from Santa Fe and successor BNSF.





11. A pair of NPSF EMDs delivers empty tank cars to the ethanol plant. NPSF is proud of their fleet, and has paid respect to their Santa Fe roots by maintaining a fleet of blue-and-yellow Warbonnets.



12. The ethanol plant requires an endless supply of grain. Blocks of grain cars arrive from BNSF, and NPSF picks them up for weekly delivery to the plant.

Also, the local switch crew delivers a tank car of gasoline every second session (this is mixed into ethanol, making it unfit for human consumption and therefore exempt from liquor taxes).

RIBERA

North of Rowe is the small town of Ribera, which our research shows had only an old water tower from the days of steam. We built the water tower, but we added local industries like a propane dealer, small lumber yard, a plastics manufacturer and an asphalt plant. This gave it the look of an old Route 66 town but with some action for switching [13, 14, 15].

The distance between towns was important to me. There are plenty of areas that have long runs through the beautiful desert scenery such as the areas of Glorieta and Ojita [16].



13. A Rail Runner commuter train arrives at Ribera.



14. A B40-8W leads a freight through Ribera as a Rail Runner commuter train calls at the depot.



15. NPSF serves a propane dealer and a plastics plant in Ribera. Here a local delivers a carload of plastic pellets to the plastics plant after having spotted a car of propane.



REGISTER
(free)

[INDEX](#)

[TABLE OF CONTENTS](#)

ALBUQUERQUE

The NPSF interchanges with the BNSF south of Lamy at Albuquerque, which is located on the lower level. Abajo yard and Albuquerque station are modeled, along with the auto terminal, intermodal terminal, team tracks, and local industries [17]. The New Mexico Rail Runner is also a part of the area, like the prototype.

The number of trains in a session requires three people to run Abajo Yard. BNSF has noticed NPSF's reliable service, and has



16. A rebuilt U36C hauls the dinner train through the desert. The railfans in the foreground needed their Jeep to make it through the rough terrain.

contracted the NPSF to serve many of these industries in the Albuquerque area so they can focus on their core business.

Trains running out of the Abajo Yard serve industries in Hahn and Rio Bravo with turns that keep operators busy. Unlike the industries of the upper level, most of the industries are rail-served, or at least they were at one time. With modeler's license, they still are.

HAHN

Hahn is only a few miles east of Albuquerque, but it offers many rail-served industries. The Hahn switch job includes a large General Mills plant, a furniture warehouse, and several other industries [18, 19, 20, 21].



17. Passengers wait for the Southwest Chief to arrive at Albuquerque. The scratchbuilt station is about two inches deep.



[REGISTER](#)
(free)

[INDEX](#)

[TABLE OF CONTENTS](#)



18. A leased CIT unit hauls grain around a curve at Hahn on its way to the General Mills plant.



19. Upon arrival at the General Mills plant, the switcher exchanges loaded grain hoppers for empties. Cheerio!





20. A BNSF geep works the American Furniture Warehouse in Hahn. Although the prototype is no longer rail-served, the NPSF's marketing department has managed to revive it.



21. Sysco catering and Hahn Paper Company round out the businesses at Hahn.

Get more articles like this

GIVE IT A LIKE



REGISTER
(free)

[INDEX](#)

[TABLE OF CONTENTS](#)

RIO BRAVO

Just to the west of Albuquerque is the town of Rio Bravo. Industries at Rio Bravo include Bio Papel, DPC Chemical, and Pueblo Recycling [22-24]. A wide variety of industries allows the NPSF to employ a wide variety of cars.



22. BNSF GP60M 115 and an FURX lease unit set out boxcars for Bio Papel paper recycling at Rio Bravo.



23. A lone tank car is being unloaded at DPC Chemical (right).

STAGING AND OPERATIONS

In the layout's early days, the lower level was reserved for staging. But after we started operating, we changed the plan to put staging at the end points of the railroad, at Belen and Raton to allow point-to-point operations. Equipment interchanged with BNSF is now stored off-layout in drawers. Outbound rolling stock is pulled between operating sessions, and incoming cars are staged in Belen and Raton to move at the start of an operating session.

The NPSF has the look of a finished railroad. All the scenery is in, and the trains have been rolling for about 15 years. Motive power and rolling stock have been upgraded, and there have been small improvements such as new lighting. Along the way.

The layout has been DCC right from the beginning, using NCE. It is double decked, with trains moving between levels on a



24. My friend John destroyed his wife's blender to make the crushed-up junk in this scene. Who says you can't use old pieces of kits to make a scene?

lengthy grade. With the assistance of a dedicated crew, we have vastly improved operations. What started with a basic paper scheduling for operating sessions has now advanced to a fully automated system using JMRI's Operations Pro. The system has schedules trains and movement to the more than 30 industries.

An operating session has three locals (which we call turns) that can take crews as much as an hour-and-a-half to complete. They range in length from cuts of three cars to trains of 12 cars, depending on the industry's demands. The design of the layout, for the most part, allows the crews to go in different directions without interfering with each other.

Throw in the Amtraks Southwest Chief and New Mexico Rail Runner commuter trains, and the train crews, including the dispatcher, have a full-time job making sure everything gets to where it is supposed to go. What we have developed has kept the interest of many people, and no two sessions are the same.

During a session we can run as many as 14 trains. Specialty trains include a military train, dinner train, excursion train, work trains, and the occasional train that BNSF will divert over the line.

TOWARD MORE PROTOTYPICAL OPERATIONS

With all this activity, I realized we needed a break. We were focused on running as many trains as we could, but we were not making much of an attempt to follow prototypical practices.

We spent several months fine-tuning operations, from setting momentum in engines to making sure we follow prototype rules and safety procedures, including use of horns and bells and doing air tests. I realized we are modeling a railroad, and it was time to take operations to the next level.

This has slowed the sessions, and we are running fewer trains, which is more in line with the how a short line railroad would

operate. While we are still not sticklers for the rule book, or even close to being prototype purists, the new approach has given us a greater appreciation for what it's like to run a railroad properly.

Input from the crews has helped develop more prototypical operations. We have gotten away from trying to just get the job done.

To be like the prototype, we needed a signaling system. We have been slowly working to install LCC hardware to coexist with the NCE DCC. The LCC system is primarily going to handle the signaling system at first. The over 600 pieces of rolling stock have resistors installed on their axles to allow detection.

Other areas of refinement include details that bring life to a layout, such as active grade crossings. More equipment is being weathered to eliminate the out-of-the-box look. All the motive power has sound installed, and many hours were spent fine tuning them to all run together.

Older equipment has slowly been retired, just like the prototype. Every area, such as control panels, has had upgrades to make the switch jobs more hands-on.

THERE IS ALWAYS MORE TO DO

Like the prototype there is always more to do, whether it is equipment repair or the one thing that every layout must have done – track cleaning. The key has always been the people who helped me build and maintain the layout.

When we were building the layout, the focus was on buildings, scenery, and lighting. Now, the efforts have shifted to operation. The challenge and fun are to elevate the layout to the next level. Long-gone is the cutting of plywood and 1x4s. Now the NPSF focus is to keep meeting customer demands, not for profit but for fun.

Now only if BNSF would buy out and take back the trackage of the NPSF like they did with Montana Rail Link, I could retire. Until then I guess I have a railroad to run. ☑



NICOLO PLATAS



His first train set was received at Christmas when he was 3 months old.

Trains are in his DNA. His grandfather, who passed away when he was 6 months old, was a purchasing agent for the Mexican Railroad in the 60s. He loved trains, and Nicolò carried on the interest.

The hobby has been a great part of Nicolò's life over the years, and Marie, his wife of many years, is totally supportive.

He has enjoyed meeting great people over the years, and the journey has been great way to relax from a stressful job in the financial and insurance business.

When not working on his trains, his other hobby is cars. He still has his first car from when he was in high school, and it gave him a way to get to the local hobby stores. ■

Get more articles like this



Did you see this article?

in the FEBRUARY 2025 MRH RUNNING EXTRA!



Jim Six: Making rolling stock choices

Get full eBook now ▶

← click here

Each eBook has 80-100 pages



RUNNING
#####**EXTRA**

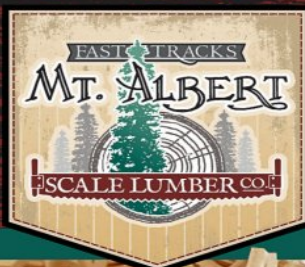

BULK CROSS TIES

5,000 AND 10,000 QUANTITIES

10% and 15% discount

MT. ALBERT PRODUCT LINE IS NOW AVAILABLE ONLINE!



Specializing in manufacturing fine scale lumber for model makers.

shop online 24/7

handlaidtrack.com
service@fast-tracks.net



Did you know ...

MRH registered members

SAVE 10%

... on the MRH Store &
on TrainMasters TV?

Click to get 10% off coupon code

(Must be a registered member to access)

Not MRH registered member?

BECOME
A registered member
(It's FREE)



REGISTER
(free)

[INDEX](#)

[TABLE OF CONTENTS](#)

Roomettes, Part 2

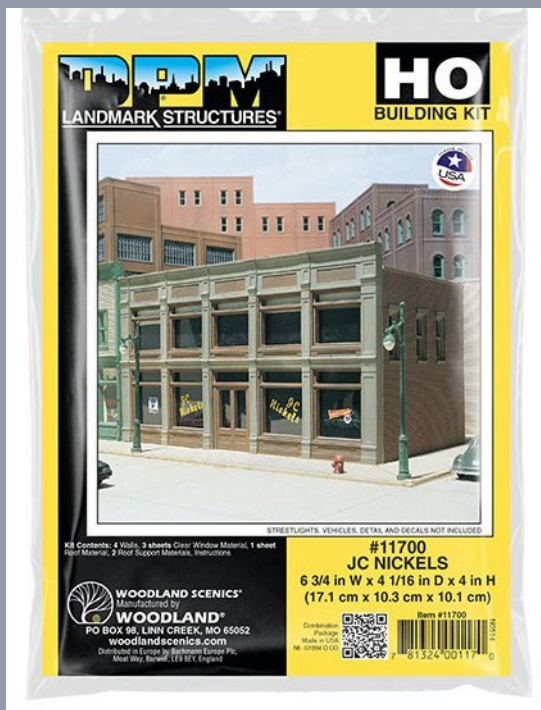

1. Woodland Scenics offers the JC Nickels Building in its DPM line, and the Sporto's Outdoor and Athletic interior in the Roomettes line as a combo that includes eight LED room lights that plug into the Just-Plug system.

Model Railroad Hobbyist | February 2025



JEFF PALMER INSTALLS LIGHTING IN HIS DPM/ ROOMETTES COMBO...

A FEW MONTHS AGO, my publisher sent me a package containing Sporto's Outdoor and Athletic by Roomettes (01-117-01) and the JC Nickels building kit from Design Preservation Models (woodlandscenics.com/show/item/R4379). In the previous installment, I discussed assembling the main structure and

ROOMETTES PART 2 | 2

the roomette interior last month. This month, I install the lighting and finish the project.

There is a small square for an LED in the top of each roomette. I applied glue around the opening, placed the LED board, and used a clothespin to hold it in place as the glue dried. I repeated the step for all eight units [2].

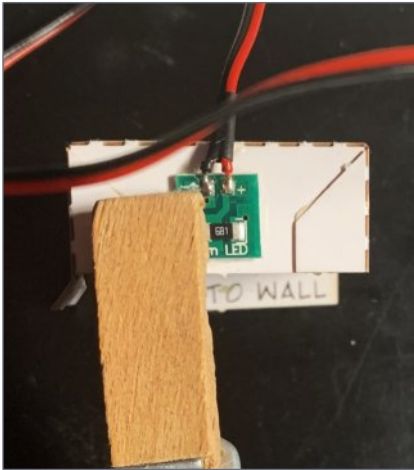

2. Installing an LED into the top of the roomette.

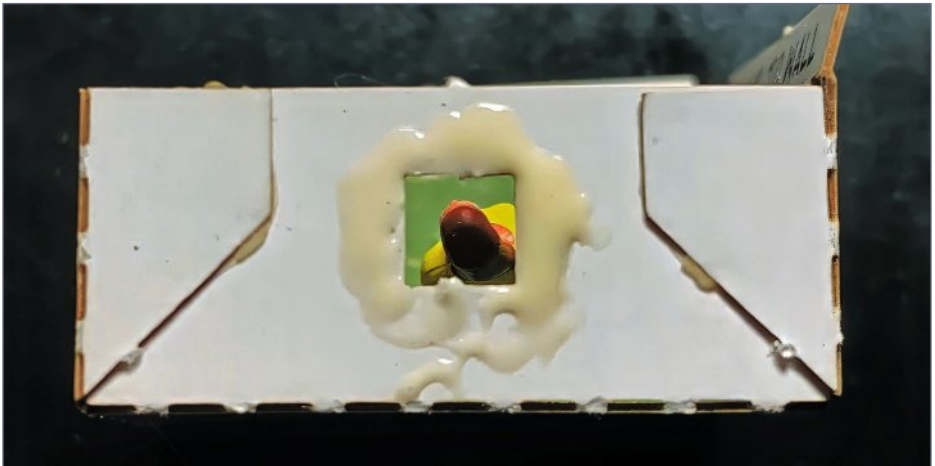

3. The perforations along the edges of this roomette can cause light leaks.



REGISTER
(free)

[INDEX](#)

[TABLE OF CONTENTS](#)

ROOMETTES PART 2 | 3

When testing the LED, I noticed light leaked through the perforations along the folded edges of the cardboard [3]. I cut a $\frac{1}{4}$ " strip of black craft paper, folded it in half, and glued it over the perforations. This eliminated most of the leakage [4].

When test-fitting the window display Roomette units, I discovered they would not cover the upper clerestory windows, except for the roomette for the entryway. There were also two windows on the second story without roomettes. I used black craft paper to cover the windows on the second story, as well as the unused clerestories on the first floor [5].

After mounting the Roomettes, I glued the front of the building to the other three walls. I used Tamiya Extra Thin Cement, and clamped the wall in place as the cement set [6].

I encountered some complications with the wires. There was nothing in the kit to organize stray wires that might rest underneath a wall, causing the building to sit awkwardly. Worse, if connectors were trapped under one of the roomettes, they might damage it.

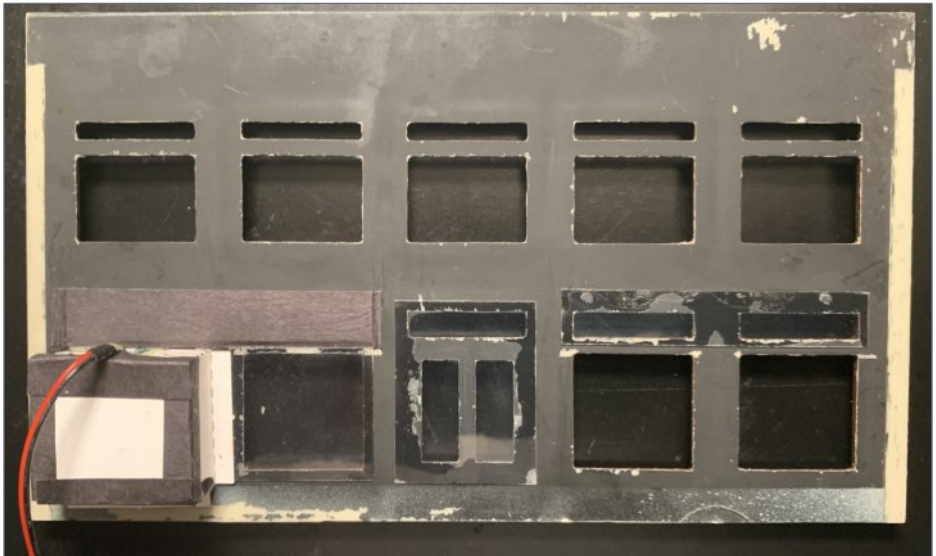

4. Testing the roomette for light leaks.

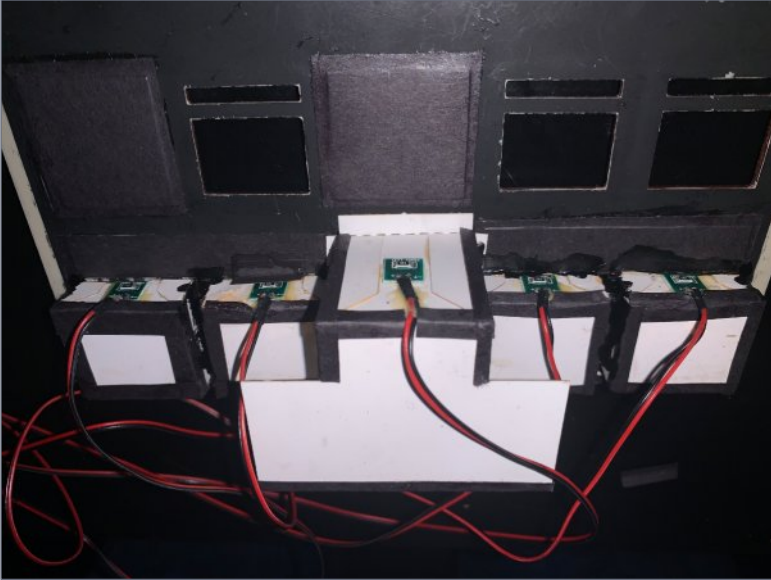

5. Only the entrance roomette unit (center) was tall enough to cover the clerestory windows. I blocked the clerestory windows of the first floor, and those windows of the second floor that will not have roomette offices.



6. Clamping the front wall to the building.



REGISTER
(free)

[INDEX](#)

[TABLE OF CONTENTS](#)

ROOMETTES PART 2 | 5

To address this, I added a base to the building using a sheet of styrene (Evergreen plain 0.080", #9080). I set the building on the styrene and traced the outline.

After verifying the building fit correctly, I sprayed the sheet a concrete gray color. I added a 3/8" hole for wires, and cut a channel to allow them to exit under the base while letting the building sit flat [7]. I then glued the base to the building, and clamped it while the glue set [8].

The wire channel I'd created could accommodate one pair of wires, but the structure had eight rooms with Just-Plug LEDs, and eight pairs of wires. Woodland Scenics offers a Just-Plug Port Sharing Device with four Just-Plug outlets [9].



7. My custom base has a path for wires to exit the building.



ROOMETTES PART 2 | 6

With eight LEDs to power, I installed two Port Sharing Devices. I mounted them to the back wall of the building using the included mounting tape, formed loops to shorten and organize the LED wires, and plugged them into the Port Sharing Devices [10]. This reduced the number of wire-pairs leaving the building to two, which is much more manageable [11].



8. Gluing the base to the building.



9. The Just-Plug Port Sharing Device. Manufacturer photo



REGISTER
(free)

[INDEX](#)

[TABLE OF CONTENTS](#)

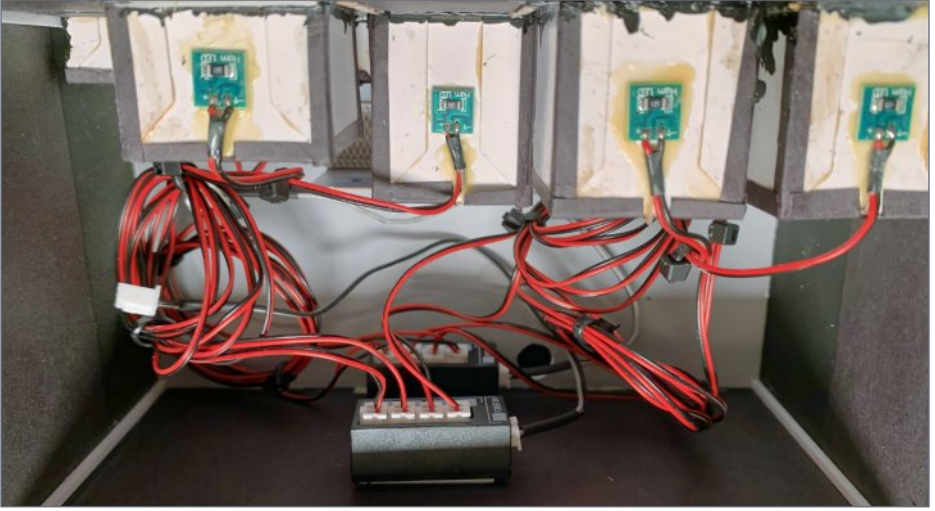

10. Just-Plug Port Sharing Devices in place and wires organized.



11. The wires exit neatly from the building.

I tested the lights on each of the roomettes as I was building the model, but with everything in place, I wanted to test one more time and look for light leaks. To perform the test, I need three more Just-Plug components, including a Light Hub, an auxiliary switch, and a power supply.

The Light Hub has a power input port and four lighting output ports that can supply power for up to 50 LEDs. It also has four dimmer controls to control the brightness of up to four groups of LEDs. Two Port Sharing Devices will use two of these ports [12].

The auxiliary switch plugs into the CTRL plug in the Light Hub, and allows you to switch it on or off [13]. The power supply is a wall wart with 20VDC output. It has a plug that connects it to the power-in port on the Light Hub.

Once I had all the ports plugged in, I flipped on the switch to check the results. Everything lit up, without any light leaks [14]. Although the cardstock of the roomettes allowed light to bleed through, the black paint on the interior prevented any glow through the building's plastic [15].

I decided to do some experimenting with the Just-Plug Lighting System. I had divided the lights in my building into two Port Sharing Devices, with one device serving the four window displays and the other serving the three upstairs offices and the entrance.



12. The Just-Plug Light Hub.
Manufacturer photo



ROOMETTES PART 2 | 9

This arrangement allowed me to control the brightness of the window displays separately from the rest of the building. I altered the brightness of the display windows and the entrance and offices. I can highlight the portions of the building I want noticed.

This experiment made me curious about what other light features might be available. I decided to experiment with other

Just-Plug products listed on the Woodland Scenics website (woodlandscenics.com/show/category/JustPlugLightingSystem) [16].



13. The Just-Plug auxiliary switch. *Manufacturer photo*



14. Success! Everything lit nicely, with nothing lit that shouldn't be.



15. The roomettes glowed, but the building did not.

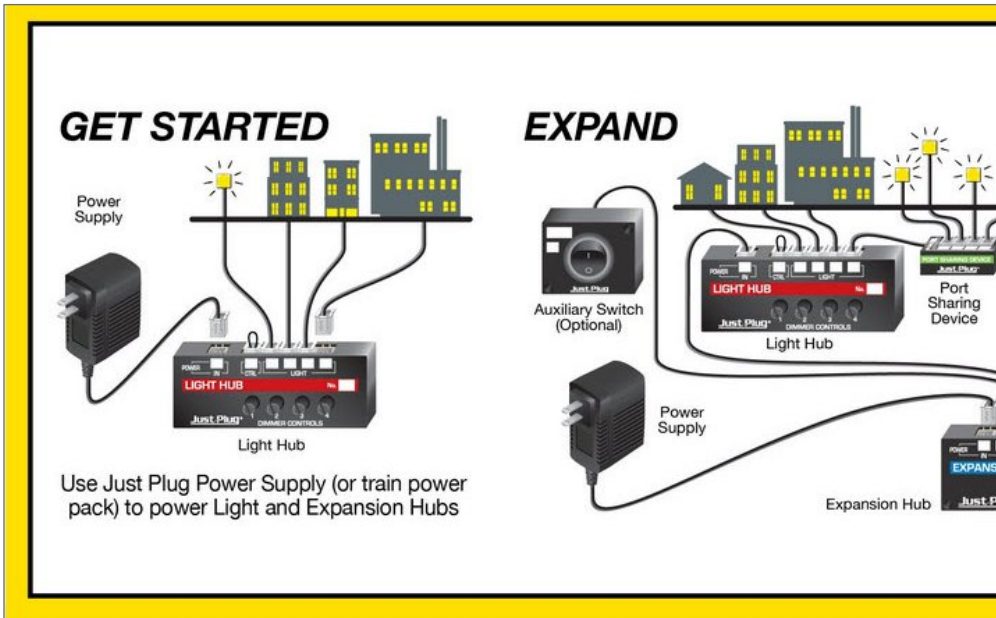

REGISTER
(free)

[INDEX](#)

[TABLE OF CONTENTS](#)

MANUFACTURER DIAGRAM

The Roomettes interiors add interest to any building's windows. Adding lights draws attention to the windows, and adds life to the scene. Using the Light Hub, the brightness of the scene can be varied, but more importantly, the brightness of the scene can be set to a different level than other scenes – like it is in the real world.

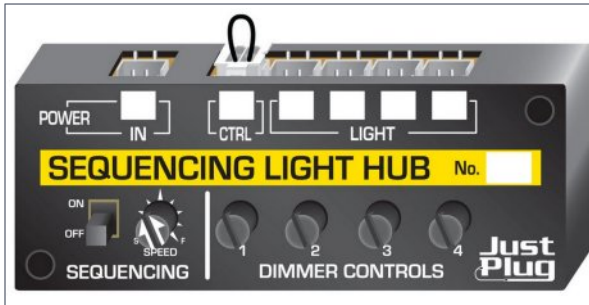

17. The Just-Play Sequencing Light Hub.

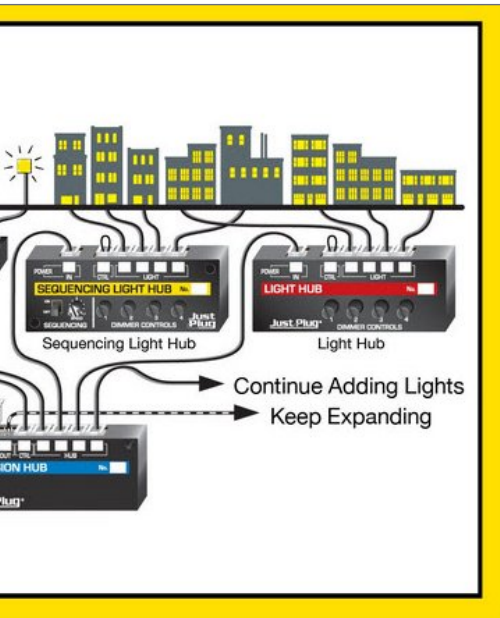

16. The Woodland Scenics website lists several accessories, and provides this diagram to illustrate how to set them up. *Manufacturer diagram*



Another way of drawing attention is to allow the lights to turn on and off as if someone were walking through the various rooms of the building. The Just-Plug system has a Sequencing Light Hub with a timing feature to control lights in intervals to simulate that sort of movement [17].

I still needed a roof to finish the model. The DPM kit contains a thin sheet of styrene that needs to be cut to fit for the roof, but has no roof details. The plans call for the roof to be glued on.

I wanted a removable roof to be able to access the LEDs if needed. I used 0.1" x 0.1" styrene strips, each cut to 23 scale feet, and glued them into each corner of the building to serve as supports for a removable roof [18].

I then went to the parts bin to look for details. Since this is a commercial building, I think an air conditioner is in order, which means a unit, some duct work, and roof access. I found a rooftop HVAC unit from Diorama Hobbies [19].

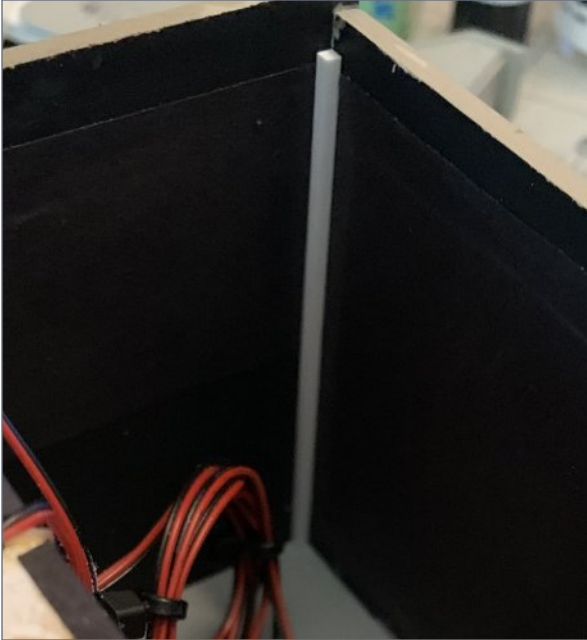

18. Styrene roof support.

ROOMETTES PART 2 | 13

The unit is hollow, which is an advantage because it would sit toward the center of the roof, just where it makes a convenient handle for removing the roof. I filled the unit's cavity in with five-minute epoxy to add bulk, and added a 1" #6 screw that will go through the roof to add strength to the handle.

I placed the screw in the HVAC unit before pouring the epoxy, making sure it was perpendicular so that it would go through the roof [20].

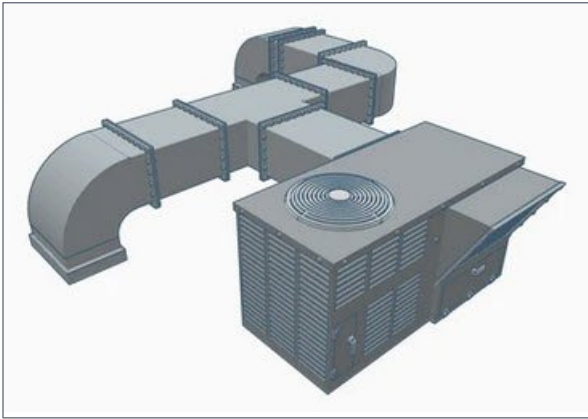

19. The rooftop HVAC unit from Diorama Hobbies.



20. Screw is placed and epoxy poured.

ROOMETTES PART 2 | 14

I mounted the HVAC to the roof, and while the epoxy was curing, I used a piece of styrene stock to reinforce the roof around the screw, and added a washer as well [21]. Later I will fasten the screw in place with a nut.

I supplemented the roof detail with plumbing stacks and smoke jacks, and added a roof access. To finish the roof, I covered it with scale gravel [23].

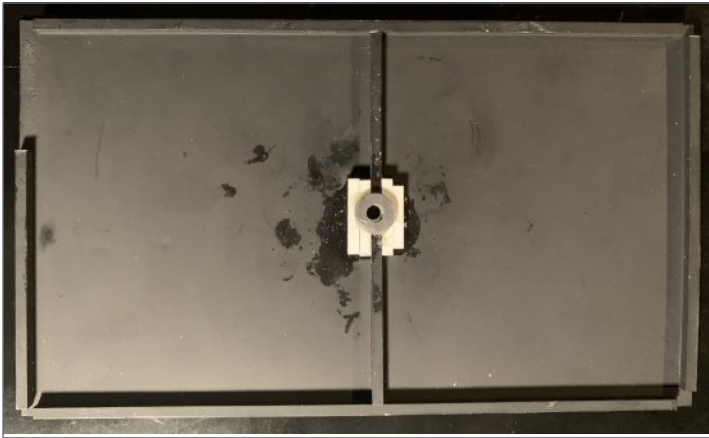

21. Styrene stock reinforces the center and edges of the roof. The gap in the upper-left corner is to avoid the roof interfering with the second-

story office. The center styrene and washer will reinforce around the screw from the HVAC.

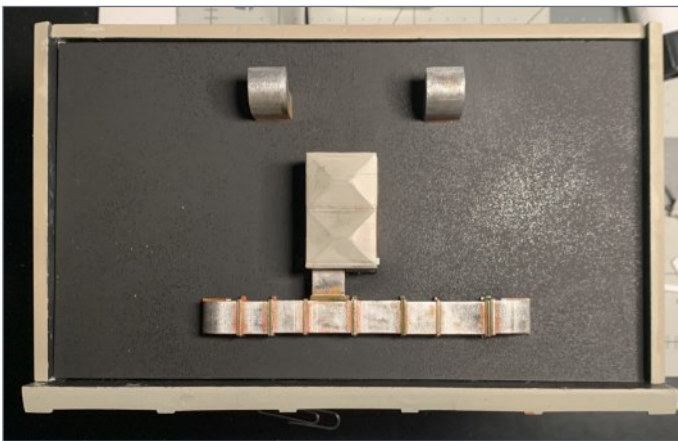

22. The HVAC unit is in place.



REGISTER
(free)

[INDEX](#)

[TABLE OF CONTENTS](#)

The sign was the one remaining detail [24]. The picture provided with the Roomettes kit showed a sign just above the entrance, but provided no structure for it. I went back to my styrene stock, and found a ¼" strip and a 0.080" L-angle strip to provide the sign structure (Evergreen Scale Models #129 and #292).

I used the sign as a pattern to cut a length of flat stock, then used that to measure the L-support structure pieces for the sign. I created legs for the sign using the L-angle strips.

I added nut-bolt-washer details to the four sign legs, and painted and weathered the structure [26]. When complete, I secured the sign to the structure using Aileene's Stick Glue, and secured the sign to the building with CA [25].

The roomettes add detail and establish a point of interest for the structures. Viewers need to look into a window and see something. At the suggestion of the Roomette instructions, I added figures.

At first glance, they sell the idea of a well-detailed interior. When I constructed the roomettes, I left some of the units empty so I could evaluate whether adding figures makes a difference. It does – it brings the units to life [28].

Diehard modelers can add gutters, electrical box, and – if the side walls are exposed – add wall signage. This was a fun project



23. Roof details are all in place.

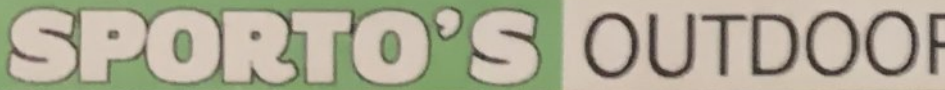

SPORTO'S OUTDOOR

24. The kit included this sign.



25. The completed sign structure.



26. The completed sign structure.

that allowed me to stretch my skills in only a couple of evenings. Roomettes improve and add interest to any structure.



REGISTER
(free)

[INDEX](#)

[TABLE OF CONTENTS](#)

R & ATHLETIC

JEFF PALMER



Jeff spent 50 years developing software, 25 of which were as a college professor. He loves to build structures, bridges, scenery, and locos. He enjoys narrow gauge logging and mining.

He is always on the lookout for new techniques, and tools that improve the hobby. Model railroading allows him to work with his hands, and share techniques with his friends.

About 2 years ago, he completed his MMR certificate. During that journey, he had the privilege of meeting many of the modelers he looked up to, like Gil Freitag, Duane Richardson, Chuck Ellis, George Sellios, Marc LaChey, Dave Revelia, Dave Frary, Scott Mason, and others. His goal is to be recognized in this group someday. ■

Get more articles like this

GIVE IT A LIKE





27. Figures bring the structure to life.



REGISTER
(free)

[INDEX](#)

[TABLE OF CONTENTS](#)

INDOOR & ATHLETIC





WAIT!

**MRH helps
you avoid
breaking the
bank!**

HOLIDAY SPECIAL:

Subscribe now and get
the next 12 issues plus
ALL 71 BACK ISSUES!
(37 cents per issue)



MRH **RUNNING**
EXTRA
Apprentice with savvy modelers

2.99 per 230+ pgs

**Get
MRH
Running Extra**

[click here](#)



REGISTER
(free)

[INDEX](#)

[TABLE OF CONTENTS](#)

SAVVY MODELER *Online*



Get more articles like this

GIVE IT A **LIKE**



Model Railroad Hobbyist | February 2024



Decaling tips for model railroaders

YouTuber **Roger Kujawa** shares some pretty cool decaling tips in this video.

Don't let the short-and-sweet five-minute running time of this video fool you – Roger shares some quite clever decaling tips

we've never seen before *anywhere else*. It's definitely worth a watch. If you want to find the goodies he suggests (and a few great alternatives we have located), here's a shipping list we've put together:

mrhmag.com/magazine/mrh2025-02/savvy-modeler-shopping



▶ GREAT MODELER VIDEOS ON THE WORLD WIDE WEB



2025 NMRA National Convention

Station No. VI
Hosted by the North Central Region of the NMRA

July 14-19, 2025

Learn more ...



Layout tours & Prototype tours



Operating sessions



Clinics & Workshops



Model showcase & Contest



**Suburban Hotel
with FREE parking**
**National Train Show
Saturday – Sunday**



REGISTER
(free)

[INDEX](#)

[TABLE OF CONTENTS](#)

FEBRUARY NEWS

column



Model Railroad Hobbyist | February 2025

RICHARD BALE AND JEFF SHULTZ
REPORT THE LATEST HOBBY
INDUSTRY NEWS ...



NEW PRODUCTS FOR ALL SCALES

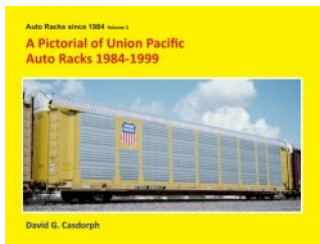

A Pictorial of Union Pacific Auto Racks 1984-1999 is a new publication from **David Casdorff**. The photographs in this new 107 page landscape format book cover Union Pacific auto racks in service from 1984 through 1999, including auto racks from railroads

merged into the UP during this period. Detailed captions on the 105 full page photos offer extensive information on the superstructure/racks.

Info: www.lulu.com/shop/david-casdorff/a-pictorial-of-union-pacific-auto-racks-1984-1999/paperback/product-zm94wmk.html?page=1&pageSize=4

O SCALE PRODUCT NEWS

Atlas Model Railroad Company has released a new production run of O scale P42 Genesis locomotives to its dealer network.

THE LATEST MODEL RAILROAD PRODUCTS, NEWS & EVENTS



Individual details applied to the ABS plastic body include separate pilots, fuel tanks, handrails, horn, roof fans and

side grilles. The lighted cab interior includes two hand painted figures. Additional LED lighting includes directionally controlled constant headlights, number boards, front marker lights and operating ditch lights.



Road names on this Atlas Premier Series model include Amtrak Phase VII, NJ Transit, and three Metro North schemes.



This Atlas O scale bay window caboose is based on a Southern Pacific C-30-6 prototype from the early 1950s. The Trainman series model features interior lighting controlled by an on/off switch on the chassis. In addition to SP,

the caboose is available decorated for CP Rail, CSX, DuPont, Guilford/D&H, Norfolk & Western, and Union Pacific.



Also just released to Atlas dealers is an O scale version of a Berwick high-cube boxcar with waffle patterned sides and double plug doors. This Atlas model is based on a series of 60'

high-capacity cars built by Berwick Forge & Fabricating Co. in the late 1970s.

Special features on this Master Series model include etched metal safety platforms, diecast metal ladders and stirrup steps and 100-ton roller-bearing trucks with rotating bearing caps. Road names available on this release include Conrail, Louisville & Nashville, Union Pacific, Norfolk Southern, Denver & Rio Grande Western, and Detroit, Toledo & Ironton.



REGISTER
(free)

[INDEX](#)

[TABLE OF CONTENTS](#)

Atlas offers both 2-rail and 3-rail versions of the O scale models mentioned in this report.

Info: shop.atlasrr.com

S SCALE PRODUCT NEWS

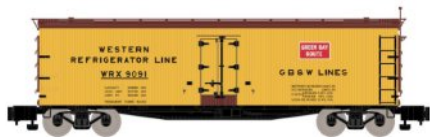

ScaleTrains has announced that a new **S-Helper Service** S scale ACF 40' woodside reefer is available for pre-order. Used by American railroads between the 1920s and 1960s, these ice reefers will be available decorated for Western Refrigerator Lines, Union Refrigerator Dispatch, Santa Fe Refrigerator Dispatch, Fruit Growers Express, Bangor and Aroostook, and American Refrigerator Transit. Additionally, undecorated models in orange and yellow will be produced.



The S scale plastic model features opening roof hatches, metal handrails and grab irons, and a separately applied brake wheel. The model includes American Flyer-compatible wheels with scale code 110 wheels included in the package and diecast sprung metal trucks. Both American Flyer-style operating couplers and scale Kadee-compatible couplers are included. The model is designed for a minimum radius of 20". Models will be available by direct order from ScaleTrains only, with pre-orders due by February 24, 2025 for an estimated arrival of October 2025.

Info: www.scaletrains.com

HO SCALE PRODUCT NEWS



New economy-priced HO scale car kits coming soon from Accurail include this 40' PS-1 steel boxcar decorated for the New York, Sus-

quehanna & Western Railroad. Details include a six-panel Pullman Standard sliding door.



Also in the near future from Accurail is a kit for a BNSF triple-bay covered hopper car.

Decorations on the ACF-built car include yellow conspicuity stripes.



Accurail's HO scale kit for this Philadelphia & Reading boxcar is based on a double-sheathed wood prototype built in 1918 with metal ends and a fishbelly underframe.



Accurail's future releases include this 40' AAR riveted steel boxcar decorated for the Illinois Terminal Railroad. All Accurail car kits

come with appropriate trucks with Delrin wheelsets and Accumate knuckle couplers.

Info: accurailinc.com



R. Bale

EMD GP7 DIESEL LOCOMOTIVE

Introduced in 1949, the GP7 was the first model in EMD's general purpose (GP) series of locomotives. It was also the first EMD road locomotive to utilize a hood instead of a full car body design. Although narrow enough to allow outside walkways, the full height hood comfortably accommodated EMD's 1,500 horsepower 16-cylinder 567 diesel engine. The hood concept was an immediate success since it cost less to build, was cheaper and easier to maintain, and offered much better fore and aft visibility for the operating crew. The standard truck for GP7s was EMD well-regarded, and heavy, Blomberg truck. Locomotives delivered with lighter AAR switcher trucks were designated GP7L. When shopping for new locomotives, many railroads found it more economical to rebuild their reliable GP7s rather than to purchase new equipment.



REGISTER
(free)

[INDEX](#)

[TABLE OF CONTENTS](#)

Athearn plans to deliver Genesis series GP7/GP7L locomotives in 11 road names with a total of 31 variations in road specific details in the fall of 2026.



At the top of the long list are four Rock Island GP7s with skirts, a Mars light and Blomberg B trucks.

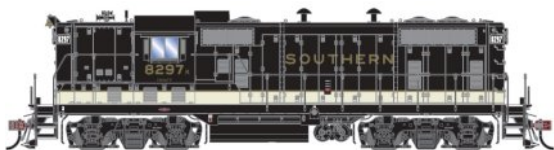

GP7s decorated for Southern Railway and Seaboard Coast Line have lost their skirts. The SOU unit has dual exhausts with spark arrestors while the SCL unit features four exhaust stacks. Both roads come with Blomberg B trucks.



A Reading unit has footboards, skirts, Blomberg B trucks and is the only GP7 in this release with dynamic brakes.



This Conrail locomotive represents a Morrison-Knudsen GP8 rebuild. The Blomberg B trucks have been retained but the original skirts have been removed.



Several U. S. Army GP7Ls with AAR trucks were later acquired by Alaska Railroad.



GP7Ls wearing Louisville & Nashville livery have footboards and AAR trucks.

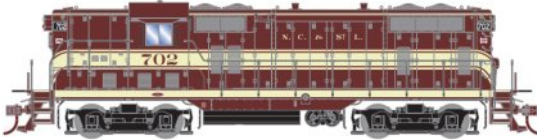

Louisville & Nashville's 1967 acquisition of the Nashville, Chattanooga & St Louis included several nicely dressed GP7L locomotives. L&N relettered their newly acquired GPs while retaining the original paint scheme.



Completing Athearn's assortment of Geeps is a GP7L decorated for Tennessee Valley Railroad.

Features on all versions of the Genesis GP7/GP7L/GP8 include LED lighting, uncoupling bars, trainline and MU hoses, MU stands, drop steps (unless noted otherwise), nub tread on walkways, windshield wipers, lift rings, wire grab irons, cab interior and see-through cab windows, etched metal grilles, roof access hatches per prototype and fuel tanks detailed with fuel fillers, fuel gauges, breather pipes, and retention tanks.

The Genesis four-wheel driveline will have all-wheel electrical pickup and a 5-pole skew wound motor with dual machined flywheels. DC versions of the model will be DCC-ready with a 21-pin NEM connector. Sound equipped models will come with SoundTraxx Tsunami2 sound and a DCC decoder.

[Get more articles like this](#)

GIVE IT A LIKE



REGISTER
(free)

[INDEX](#)

[TABLE OF CONTENTS](#)



R. Bale

4-4-0 AMERICAN STEAM LOCOMOTIVE

The 4-4-0 wheel arrangement, also known as the American or American Standard, was a popular steam locomotive type widely used in North America throughout the 1800's. More than 25,000 were built.

The 4-4-0 was stable, uncomplicated, easy to service and capable of handling both freight and passenger service. The design utilized a narrow firebox positioned between the driving wheels which provided stability but limited its steam generating capacity. The widespread application of air brakes in the 1880s spelled the end of the 4-4-0. Air brakes made it possible to run longer and heavier trains which created a demand for bigger locomotives. As heavier motive power appeared, railroads assigned their 4-4-0 locomotives to light freight and passenger service, often on branch lines.



Athearn is developing a classic 4-4-0 steam locomotive with an expected release date

of September 2026. The HO scale model will have a diecast metal chassis and a plastic injection molded superstructure with separately applied details.



Road names with heaped coal in the tender include Santa Fe, Union Pacific, Pennsylvania Railroad, Chicago & North Western, and Grand Truck Railroad.

A 4-4-0 decorated for Frisco and a painted but unlettered version of the locomotive will have oil bunkers. Except for the brightly painted UP version, all others will be painted black with a gray smoke box and firebox.

One driver on each side will be fitted with a traction tire to offset the limited weight of the model. All wheels, including the spoked wheels on the four-wheel pilot truck and the arch bar trucks under the tender, will be nickel plated. Additional features

include see-through cab windows, LED headlight, and a 5-pole motor with a machined flywheel.

DC models will be available as well as DCC models with SoundTraxx Econami sound. The model is designed to handle 18" minimum track radius, however, Athearn recommends a 22" radius for reliable operation.



Athearn's September 2026 productions schedule includes three Roundhouse series models with improved graphics, McHenry couplers and appropriate trucks with machined metal wheelsets. Leading the upgraded Roundhouse models is a 50' exterior-post mechanical reefer with Youngstown plug doors.



Road names include a 1950s/60s-era SFRC-Santa Fe car with blue MTC promotional doors. Additional decorating schemes include NWMX-Chicago & North Western, FGCX-Fruit Growers Express, RBBQ-Burlington, and two PFE schemes.



A basic injection molded 50' flatcar will be available decorated for Great Northern, New Haven, Reading, Milwaukee Road, Boston & Maine, U.S. Army, and U.S. Department of Defense.



Road names scheduled for a wood 36' ice bunker reefer model from the truss rod era include Southern Pacific, Oscar Meyer, Schlitz Beer, Purina, Wilson Meat, and Dubuque Packing.

Info: www.athearn.com



Atlas made several pre-order announcements at the end of January, beginning



REGISTER
(free)

[INDEX](#)

[TABLE OF CONTENTS](#)

with a new run of HO scale Master U30C Phase II and III locomotives. The 3000hp units were designed to compete with EMD's SD40 line of locomotives, and 600 of them were built between 1966 and 1976.



Road names in this run are Burlington Northern, CSX, Delaware & Hudson, KYLE (BN Patch), Lake Superior &

Ishpeming, Louisville & Nashville, Missouri Pacific, Southern, and Southern Pacific. A KYLE limited edition collectors series paint scheme will also be available.



The Atlas U30C features golden-white LEDs, a diecast underframe, detailed crew members,

separate windshield wipers, metal grab irons, and fine scale handrails. The models are equipped with ditchlights as appropriate.



For the Alco fans, Atlas is taking pre-orders for a new run of Alco C424/C425 locomotives. Designed to

compete with the 2,500hp GE U25B and EMD GP35, the C424 only made 2,400hp, and after two years in production the C424 was joined by the C425, which also had a higher capacity main generator, improved electrical system and radiator, and a more powerful 251C prime mover producing 2,500hp.



Alco C424s in the new run are Conrail Patch, Canadian Pacific, Canadian National, Erie Lackawanna, NdeM, and

Wabash. Paint schemes for the C425 in the new run are Burlington Northern and New Haven.



The model includes two painted crew members, golden white LEDs, separately applied wire grab irons, ladders, drop steps, and marker lenses. The C425 Phase 2 models cab lights are horizontal or vertical per the prototype.



A new run of MP15DC models is also part of the late January announcements, with models featuring ditch lights as appropriate. Paint schemes in the run are Alaska, BNSF (H3), CSX (YN3), Lehigh Valley Rail Management, LTEX, Philadelphia Bethlehem and New England, Pittsburgh and Lake Erie, and Union Pacific.



The MP15DC model has several road specific variations, including three different hood styles, muffled and unmuffled exhaust stacks, two different long hood sand fills, three different cab sand boxes, plain or snowplow pilot, and many separately applied detail parts.



Atlas locomotives are available in both Gold Master, with ESU LokSound DCC/Sound, and Silver Sound Ready, with a prewired speaker, versions. Pre-orders are due March 12 for estimated arrival in 4th Quarter 2025.

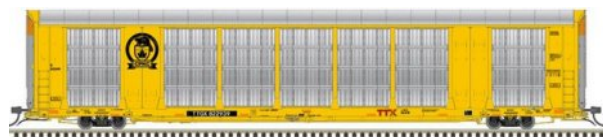

A new run of HO scale Gunderson Multi-Max auto racks is available for pre-orders, with delivery expected in 3rd Quarter 2025. Road names for the new run are Canadian Pacific Kansas City, CSX, Ferromex, Norfolk Southern, and Union Pacific.



REGISTER
(free)

[INDEX](#)

[TABLE OF CONTENTS](#)



A new model being introduced by Atlas is the Minibox box car, built by multiple builders between 1929 and 1930 for Canadian Pacific Railway. Used in revenue freight service until 1983, some of the 50-ton cars were sold to Pacific Great Eastern and were later used by BC Rail MOW. Cars remaining with the Canadian Pacific were used for tasks like icicle breaking, storage, and as tool cars, with some lasting until 1993.

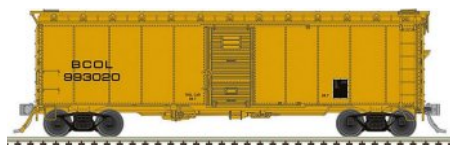

The models feature additional detail parts such as ice breakers and lumber doors where appropriate, Youngstown style doors, and separately applied ladders and brake details.



Another Atlas HO scale model scheduled for a new production run is the 33,000 gallon LPG tank car. A whale-belly tank car, they commonly hauled liquified petroleum gas (LPG) and anhydrous ammonia. Built in the early 1960s they are still found in service.



Road names in this release are ACPX, Tamak Transportation Corp. (TGPX), FMC Chemicals (ACFX), Suburban Propane (CNTX), Virginian Chemical Corp. (SHPX), Wanda Petroleum (SHPX), and Norfolk Southern Safety Train. The models feature 100-ton roller-bearing trucks, separate brake parts and brake rigging detail, walkways, end platforms, and separate handrails.



A new run of 60' auto parts boxcars in HO scale includes both single and double door models. The new paint schemes are

The Andersons (BAEX), Arkansas and Missouri, UP (ex-Rock), Southern, and Norfolk & Western. New road numbers will be available in CSX, Detroit, Toledo & Ironton, Erie Lackawanna, and Union Pacific.



The models feature 70-ton roller-bearing trucks, blackened metal wheels, sliding doors, "Precision

Design" recessed panels, separate brake system and air reservoir; cushion underframe with extended coupler pockets, AccuMate knuckle couplers, and roof overspray.



The last pre-order announcement in HO scale is for ACF 89' 4" flat cars. Two different styles of



car are part of this release, one with container pedestals and one with mid/end hitches. Road names for the container cars are BNSF, Environmental Protection & Improvement Company (EPIX), Trailer Train (ITTX), and Redstreak (QUAX). Mid/end hitch car road names are Birillion & Forest Junction (BFJR), Ferrocarril del Pacifico (FCP), Maine Central (MEC), and Trailer Train (TTAX).



Atlas has just released two new HO scale models. Although sold out at the factory, some decorating schemes of both models may still be available at

participating dealers. Heading the list is a General Electric U30B diesel locomotive. The Atlas Master Line model replicates Phase 2 versions of the 3,000hp prototype road switcher GE introduced in 1966.



REGISTER
(free)

[INDEX](#)

[TABLE OF CONTENTS](#)

Individual details applied to the plastic molded body include separate windshield wipers, metal grab irons, uncoupling levers, MU and trainline hoses and drop steps.



Road names for U30B locos with a low nose include Burlington Northern, Chessie System, CSX (ex-Chessie), Georgian Central, and Western Pacific. High

nose versions of the U30B are available decorated for Norfolk & Western and NdeM- Ferrocarriles Nacionales de México.

The models come with four-wheel Blomberg, AAR-B or FB-2 trucks as appropriate per road name. Both Silver Series models (DC with speaker and NMRA compliant 21-pin plug for an aftermarket decoder) and Gold Series (DCC ESU LokSound decoder) are available in this release.

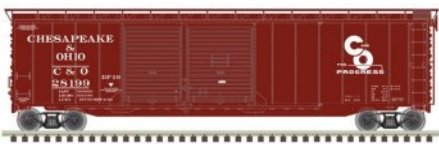

Also just released to Atlas dealers is an HO scale 50' postwar boxcar with double doors. The ready-to-run Master

Series model has one 7' and one 8' Youngstown sliding door covering an offset 15' opening.



Road names in this release include Canadian National, Chesapeake & Ohio, Erie Lackawanna, Great Northern,

Missouri-Kansas-Texas, Illinois Central Gulf, Michigan Northern, and two Santa Fe versions – El Capitan and Super Chief.

Info: shop.atlasrr.com

Bachmann has released an HO scale 100-ton triple-bay coal hopper based on a prototype introduced by Bethlehem in the 1960s. The ready-to-run model features an injection molded body with

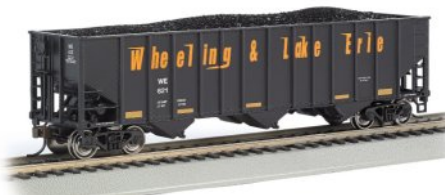

separately applied air tanks, brake valve, brake wheel, and internal bracing parts.



Road names are C&O Chessie System, Conrail, CSX, Detroit Toledo & Ironton, Norfolk Southern, Pennsylvania Power & Light, PRR, Union Pacific, Western Maryland, and Wheeling

& Lake Erie. The model comes with a removable load and E-Z Mate® Mark II couplers.

Info: www.bachmanntrains.com



R. Bale

ALCO C-415 DIESEL LOCOMOTIVE

The C-415 diesel-electric locomotive was a large switch engine (or small road engine) built by the American Locomotive Company between 1966 and 1968 as part of Alco's Century Series locomotives. Alco marketed the C-415 as a universal unit capable of handling mainline, branchline, heavy transfer and yard switching duties. The C-415 was offered with several options, the most obvious being a center cab available in three heights: A tall cab (16' 4" over rail head) for best visibility for switching, a low cab (14' 6") for industrial customers with restricted clearances, and a mid-height (15' 2") for general use. Additional options included AAR Type B trucks or Alco high-adhesion trucks. The center cab arrangement separated Alco's somewhat unreliable 251-F prime mover from the generator and radiator which required more wiring and piping, a longer driveshaft, and increased maintenance. The C-415 was a failure with only 26 being sold. By comparison, EMD's SW1500, also introduced in 1966, sold more than 800 units.



REGISTER
(free)

[INDEX](#)

[TABLE OF CONTENTS](#)



Demo, Burlington Northern, Spokane Portland & Seattle (two paint schemes), Rock Island (three schemes), and Hamersley Railway (Australia).



and road-specific fuel tanks. Bowser's C-415s will come with either AAR Type B or Alco Hi-Ad trucks depending on the practice of the prototype road name being modeled. DC versions of the model will have a 21-pin plug for an aftermarket decoder. DCC sound versions will come with a LokSound V5 decoder.



Bowser is in the final stages of preparations for an April release of an HO scale model of an Alco C-415 center cab locomotive. Models with regular height cabs will be available decorated for Alco Century

C-415s with extended height cabs will be available for Southern Pacific, Burlington Junction (two paint schemes), Chehalis Western Railroad (Weyerhaeuser subsidiary), and Columbia & Cowlitz Railway.

Features include individual air hoses, windshield wipers, grab irons, uncoupling bars, window glass, operating headlights, a can motor, knuckle couplers,

and road-specific fuel tanks. Bowser's C-415s will come with either AAR Type B or Alco Hi-Ad trucks depending on the practice of the prototype road name being modeled. DC versions of the model will have a 21-pin plug for an aftermarket decoder. DCC sound versions will come with a LokSound V5 decoder.

Undecorated models (no sound) will come with a bag of parts including both types of truck side frames, all fuel tanks, handrails, and other small parts. A sound kit for C-415s will be available as a separate purchase.

Info: bowser-trains.com



Broadway-Limited is preparing four sets of heavyweight passenger cars for release next month.



Each four-piece set will consist of a combine, three P70 coaches and a business/car with an observation deck. Each car will have a lighted interior and come with six-wheel Pullman trucks and Kadee couplers. Separate details such as handrails and operating spring diaphragms will be applied to the injection molded plastic bodies.

The four roadnames available in this release will be Chesapeake & Ohio (Tri-color), Canadian National (Green, black and yellow scheme), Northern Pacific (Raymond Loewy two-tone green scheme), and a Christmas holiday scheme.



The four roadnames available in this release will be Chesapeake & Ohio (Tri-color), Canadian National (Green, black and yellow scheme), Northern Pacific (Raymond Loewy two-tone green scheme), and a Christmas holiday scheme.

Info: www.broadway-limited.com



ClassOneModelWorks.com is taking pre-orders for a run of Thrall 86' four-door high cube boxcars. Typically used in auto parts service, they were frequently assigned to pools for particular factories or loads.

The cars come with metal wheels, knuckle couplers, and numerous separately applied detail parts. Road names in this release are Chicago Northwestern, New York Central, Union Pacific, and Western Pacific. No estimated date of arrival of the models was provided.



Info: www.classonemodelworks.com

Info: www.classonemodelworks.com



REGISTER
(free)

[INDEX](#)

[TABLE OF CONTENTS](#)



Eastern Seaboard Models has extended the reservations deadline for its HO scale XIH boxcar

to March 31, 2025. Road names on this release remain Bangor & Aroostook (1960s repaint with large herald), New Haven (1960s repaint with block herald), Penn Central, Conrail (ex-Penn Central without running board), and OKEX-Okee Industries (Freight car red without running board).

Availability is planned for late 2025. ESM cautions that reservations for each scheme must meet minimum quantity requirements for production.



ESM is developing a kit for a Delaware Lackawanna & Western wood-sheathed caboose. The kit will include several unique brass etchings. If all goes well ESN expects its American-made kit will be ready this spring.

Info: www.esmc.com

InterMountain has cancelled all reservations for its ES44AC locomotive. After the original announcement in 2021, several time consuming upgrades combined with numerous factory production delays threw a monkey wrench into the release date. Effective immediately, InterMountain and its dealer network are booking new reservations for the HO scale ES44AC. Deadline for new reservations is February 28, 2025, with production scheduled for completion by mid-year.



The HO scale model will be equipped with a new drive system, larger can motor,

heavier underframe, and a new 21-pin motherboard with several updated electronic circuits.

Six road numbers will be available for locomotives decorated for CSX including No. 3099 *Spirit of West Springfield* with GE

steerable trucks. All CSX units will also have alternating front ditch lights, a large GPS dome and extended range dynamic brakes with three intakes.



ArcelorMittal will be equipped with front and rear ditch lights and standard high-adhesion trucks.



Six road numbers each will be available for Union Pacific and BNSF models. Both road names will feature alternating front ditch lights, high-adhesion trucks and cab mounted PTC antenna arrays.



InterMountain's HO scale version of GE's ES44AC locomotive decorated for the CitiRail, the Connecticut-based commuter line, will have standard dynamic brakes with two intakes, front and rear ditch lights and a large GPS dome.



Florida East Coast units will be available in four road numbers. Features on the FEC versions include alternating front ditch lights, a GPS dome, high-adhesion trucks with extra brake cylinders and dynamic brakes with two intakes.



CN and CP units will be similarly equipped with standard high-adhesion trucks, a large GPS



REGISTER
(free)

[INDEX](#)

[TABLE OF CONTENTS](#)

come, and dynamic brakes with two intakes. Front and rear ditch lights on CP units will be non-flashing. The CN versions will have both front and rear ditch lights and operating red warning lights in the front and rear of the locomotive.



Features on all road names include uncoupling levers, MU and trainline hoses, cab

interior details, windshield wipers, lift rings, and wire grab irons. Fuel tank details include separate fillers, gauges, breather pipes, and retention tanks. The models come with Kadee-compatible metal knuckle couplers. The all-wheel electrical pickup, all-wheel drive system features a 5-pole skew wound motor with dual machined flywheels. Operating systems include a choice of analog DC or DCC with an onboard ESU Lok decoder.

Info: www.intermountain-railway.com



Kadee's latest HO scale release is a Denver & Rio Grande Western PS-2 twin-bay covered hopper car. The decorating scheme

represents a prototype as delivered by Pullman-Standard in 1956. Details include eight round loading hatches, Bettendorf-type plain-bearing trucks with metal wheelsets and Kadee Whisker couplers.

Info: www.kadee.com





R. Bale

PENNSYLVANIA RAILROAD G38 ORE CAR

The G38 was a 27' ore jenny intended for unit train rotary dumping operation. The Pennsylvania Railroad built 1,000 G38s in its Samuel Rea Shops in Hollidaysburg, PA in 1960. The cars featured a sloped interior tub with a fixed floor and ends. Ports were included on the sides of the cars so that steam probes could be inserted to thaw frozen loads in the winter. Initially the G38s were equipped with plain-bearing trucks recycled from aging hoppers. Cars upgraded with newer 77-ton trucks were reclassified G38B. The rugged ore cars continued in service through the end of the PRR and Penn Central and lasted on Conrail into the mid-1990s.

The G38 was a 27' ore jenny intended for unit train rotary dumping operation. The Pennsylvania Railroad built 1,000 G38s in its Samuel Rea Shops in Hollidaysburg, PA in 1960. The cars featured a sloped interior tub with a fixed floor and ends. Ports were included on the sides of the cars so that steam probes could be inserted to thaw frozen loads in the winter. Initially the G38s were equipped with plain-bearing trucks recycled from aging hoppers. Cars upgraded with newer 77-ton trucks were reclassified G38B. The rugged ore cars continued in service through the end of the PRR and Penn Central and lasted on Conrail into the mid-1990s.

Lionel Trains has introduced an HO scale version of PRR's 27' rotary ore car. The models feature a plastic body and hidden metal weight with separately applied brake system, coupler and safety details. The models are available singly and in four-packs.



Single cars have operating metal couplers compatible with other brands of HO scale knuckle couplers. Four-packs have operating couplers on one end of two cars with scale non-operating rotary-style couplers in the other positions.



Models of the PRR as-built G38 come with 70-ton 2E-58 trucks. G38B ore cars decorated for Penn Central and Conrail Models have later 77-ton trucks. Undecorated models, available in black and

brown, come with 77-ton trucks.

One piece ore and taconite loads are available as a separate purchase. They feature a metal insert that allows removal with a magnet.



REGISTER
(free)

[INDEX](#)

[TABLE OF CONTENTS](#)



Lionel has also announced the production of a 2-8-4 Berkshire model in HO scale.

Featuring new tooling, road specific details, and modern electronics, this is the first new HO scale steam locomotive from Lionel in over 20 years. Locomotives will be available decorated for Chesapeake & Ohio as Kanawhas, Nickel Plate Road, and Pere Marquette.



C&O locomotives #2727, #2732, and #2736 represent members of the first order of 2-8-4s

received from Alco in 1943, with #2716 receiving a shinier paint scheme including polished rods, gloss paint, and a Pyle headlight in anticipation of its return to steam. C&O #2699 is a former Pere Marquette locomotive and includes Pere Marquette details and a "C&O for Progress" logo on its tender. C&O #2789 is decorated in a fantasy passenger scheme used on some of the streamlined C&O locomotives.



The Nickel Plate locomotives include #757, #763, and #765 in the standard NKP livery as class

S2 Berkshires, which entered service in 1944 and 1945. Working Mars lights are included on the smokebox front, which is appropriate for S2's in the 1950s. NKP #765 is decorated for its excursion service with polished rods, a Pyle headlight and gloss paint job. NKP #759 participated in the 1969 Golden Spike ceremonies in a special blue paint scheme with "American Railroads" on the tender. A fantasy passenger paint scheme decorates NKP #766.

The last road name in the first release of the 2-8-4 Berkshires is Pere Marquette, with class N1 locomotives #1216 and



#1223 in the standard PM paint scheme and #1225 in the glossy excursion paint

scheme, polished rods, and modern headlight, ready to lead a Polar Express on the movie screen.



All of the Berkshire/Kanawahs feature diecast metal boilers, LED lighting, road number specific

detailing, and a detailed cab interior with crew figures. The locomotives also include all-wheel pickup and metal knuckle couplers. Models equipped with ESU LokSound 5 Sound/DCC decoders include fan-driven smoke and engine, whistle, and bell sounds in DC mode. DCC ready locomotives are equipped with a DCC socket.

Info: www.lionelstore.com/online-catalog

Moloco has completed a third production run of ACF 50' high-cube boxcars. The HO scale models, which exceed Plate C clearance, accurately replicate non-waffle prototype cars ACF delivered in the 1970s with a pair of uniquely tall 8' wide Youngstown plug doors.



Seven road numbers are available for an ATSF Bx-154 class Shock Control car wearing Santa Fe's Indian Red paint scheme.



This ATSF car is available in one road number. It represents a Bx-154 repainted in mineral brown in 1988.



REGISTER
(free)

INDEX

TABLE OF CONTENTS



Moloco is offering this ATSF Bx-163 class boxcar in six road numbers. A mineral brown repaint of this car is also available.



This BN version of the boxcar is available in nine road numbers.



Completing Moloco's third release of the 50' high-cube non-waffle boxcar is a 1998 BNSF repaint.

Features on all versions of the Moloco model include metal corner stirrup steps, Stanray T3-3-3 ends, 70-ton roller-bearing trucks with machined metal wheelsets and Kadee Whisker couplers. The hand brakes are road name and road number specific and may be Ajax, Ellcon-National, Equipco, Klasing, or Universal.

Info: www.molocotrains.com



Prairie Shadows is taking pre-orders for PD5000 Pressure Differential covered hoppers.

Originally built in the 1980s by North American Car Company (NACC) and Thrall, the cars were designed to haul powdery materials such as corn starch, clays, flour, kaolin, and talc.



In the first run, NACC cars come decorated in multiple NAHX paint schemes, including plain, stenciled,

Grace Davison, Filtrol, and Wonderbread/Hostess. A NACC car decorated for Soo Line is also in the run. Thrall-built car paint schemes include NAHX plain and Bentonite, and FURX repaints.



The models feature multiple car bodies and weld seam variations, multiple roof variations, roof walk support variations, see-thru etched metal walkways, and detailed brake rigging and piping. Equipped with 100-ton trucks, the models feature 36" CNC metal wheels and Kadee scale couplers.

Info: www.prairieshadows.com



R. Bale

ACF HELIUM CAR

The use of blimps by the US Navy and Air Corps began prominently during World War I. Prior to the use of helium, these airships were filled with flammable hydrogen. American Car & Foundry produced a total of 120 cars between 1955 and 1961. Each of these 100-ton cars contained 30 individual high-pressure tanks, which could be filled and emptied from the end cabinets. Remarkably, a single car could fill more than two L Class blimps. During the space race, NASA regularly utilized these cars; however, after 1969, the demand for them diminished significantly. By 1998, all cars had either been retired from rail service or scrapped, Rapido.



The product development team at **Rapido Trains** is working on an HO scale model of an ACF Helium Car. An accurate model of the prototype is assured through the use of ACF blue-

prints and field measurements.

This well-detailed 3D pilot model was shown at the recent Springfield show. Decorating schemes include ATMX (Gray and silver), MHAX (Gray and silver), MHAX (All silver) and painted silver unlettered.



REGISTER
(free)

[INDEX](#)

[TABLE OF CONTENTS](#)



Features on all versions of the Helium Car include a fully detailed underbody including all piping, separate grab irons, an etched stainless steel Blaw-Knox style running board and latitudinals,

appropriate trucks with machined metal wheelsets, and metal knuckle couplers. The deadline for ordering is April 15, 2025.



In addition to the Canadian National and VIA Alco FPA-4 and FPB-4 locomotives detailed in

our December report, Rapido has announced plans to produce FA-1 and FB-1 version of the flat-nosed diesel in eleven decorating schemes with options for A or A-B sets.



The road names include Wabash, New Haven, New York Central, Rock Island, Burlington Northern,

Erie-Lackawanna, Lehigh Valley, Long Island Railroad, Soo Line, Missouri Pacific and Spokane, Portland & Seattle.



Both dynamic and non-dynamic brake versions will be available.

Additional features will include etched side and fan screens, separate grab irons and handrails, full underbody piping and conduit and operating classification, back-up and headlights.



The models will be available for DC operation and DCC Sound with an ESU LokSound

V5 decoder and MoPower capacitor system for uninterrupted

DCC power. The deadline for ordering is April 15, 2025 with availability TBA. All photos are courtesy of Rapido Trains Inc. Info: www.rapidotrains.com

Tangent announced the immediate availability of a selection of PRR X58 class boxcars at the Amherst Train Show in West Springfield, MA late last month. More than 2,500 of the X58 prototype cars were built by PRR between 1964 and 1966. An additional 100 were constructed for Lehigh Valley. A variety of interior loading appliances were installed resulting in four subclasses: X58, X58A, X58B, and X58C.

Significant details in Tangent's HO scale models include high or low ladders and hand brake appliances, Keystone or Hydra-cushion underframes, trombone-style uncoupling bars, a newly tooled 50' Stanray diagonal panel roof, Kadee couplers and ASF 70-ton roller-bearing trucks with machined metal wheels.



Models decorated for PRR include this X58B in boxcar red with an Apex running board and an unpainted galvanized roof. Six road numbers are available. A similar PRR car with a green door is also listed in this release.



Five different Penn Central cars are available including two Cushioned Cars in boxcar red with ACI labels and full height ladders.



Early 1970 Penn Central repaints with lowered ladders and hand brakes are available in PC green and in very light gray as a single service car for the Diesel Locomotive Shops in Cleveland, OH. A similar car is available with a BCR door on one side only.



REGISTER
(free)

[INDEX](#)

[TABLE OF CONTENTS](#)



Three Conrail cars are available in this release including a 1976 repaint in green and a 1977 Meadville repaint in boxcar red with a small CR can opener logo.



A one of a kind CR "Safety-On-Rails-Theater" car, circa-1992, is included in this release. The paint scheme, which includes a white roof,

celebrates the Philadelphia Division's dedication to rail and grade crossing safety.



The third Conrail X58 is a very light gray ex-Lehigh Valley car with different patches on each side of the car.



This Lehigh Valley model replicates the LV's second group of X58B cars built in late 1965. Like the prototype, Tangent's HO

scale version has a high hand brake, full height ladders, an Apex running board, and 10' plug doors.

Info: www.tangentscalemodels.com



ScaleTrains has announced several new products recently, including Rivet Counter EMD SD7, SD7R, and

SD9 locomotives. The EMD SD7 was introduced in 1951 as a six-axle version of the 1,500hp GP7 locomotive. Riding on 3-axle

Flexicoil trucks, the SD7 enjoyed greater tractive effort and less slipping through the additional two traction motors. Some SD7s were equipped with steam generators for passenger service and included a 1,200 gallon water tank located next to the 1,200 fuel tank. The SD9 was introduced in 1954 with an improved 1,750hp 567 prime mover. Referred to as “Cadillacs” by their crews due to their smooth ride, many SD7s and SD9s were rebuilt by their owners and have served on into the 2010s and 2020s on shortline railroads and at industries.



Models announced by ScaleTrains include the SD7 in Union Pacific, Great Northern, and Chicago Burlington & Quincy, the SD7R in Southern Pacific, the SD9 in Conrail, and the SD9M in Norfolk Southern. The SD9M will be available both with and without ditch lights.



The Rivet Counter locomotives will be equipped with road number specific features such as the type of drop steps, MU hose accessories, and antennas. Features on all the models include LED ground and walkway lights, three color LED class lights (SD9), number boards on the high hood ends, 4-hose MU clusters, metal Type E knuckle couplers, see-through 36" fans, detailed Flexicoil “C1” trucks with separately applied brake cylinders, piping, and flexible rubber sanding lines. DC/DCC & sound ready models will be equipped with a 21-pin socket and DCC and sound equipped locomotives will include an ESU LokSound 5 decoder and ESU designed two super capacitor PowerPack and two cube-type speakers. Delivery is expected in October 2025. Pre-orders are due by February 24, 2025.



ScaleTrains is building on its GP30 locomotive models by introducing models of GP30s rebuilt as the GP39E by



REGISTER
(free)

[INDEX](#)

[TABLE OF CONTENTS](#)

Burlington Northern, the GP30M by Chessie System, and the GP30u by Santa Fe. The GP39E program replaced the GP30 cab with its raised roof with a standard GP35-style cab, 12-cylinder turbocharged 645E3 power assemblies, and a modernized generator.



cab front, replacing it with a flat cab front. Chessie System GP30Ms maintained the same general appearance as the standard GP30.



Union Pacific, Phase Id in B&O Chessie System, and Phase IIb GP30 in Chicago Great Western. All road names will be produced in multiple road numbers.



All models will be equipped with LED ground lights, walkway lights, tri-color class lights, "McCarty" type re-rail frogs, semi-scale metal Type E knuckle couplers, and many separately installed details. DC/DCC and sound ready models will be equipped with a 21-pin socket and DCC & sound equipped locomotives will include an ESU LokSound 5 decoder and ESU designed two super capacitor PowerPack and two cube-type speakers. Delivery is expected in August 2025. Pre-orders are due by February 24.

Info: www.scalettrains.com

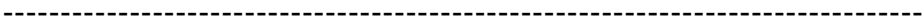



Walthers has scheduled the release of four different HO scale boxcars this spring. First on the list is a Proto Series Gunderson 50' high-cube boxcar based on a prototype designed for the paper industry. The cars extra height and wide plug door provided easy access for forklifts handling large rolls of printing paper. Road names will be Canadian National, AOK-Arkansas Oklahoma, BNSF, and CSX.

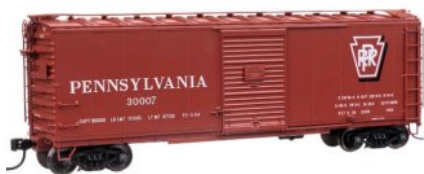

A second Proto Series model coming from Walthers this spring is a 40' Pennsylvania Railroad X29B class boxcar with an interior height of 10' 6".

Details include Dreadnaught ends, Youngstown sliding doors, a metal see-through running board and separately applied ladders and grab irons.



Models with a Circle Keystone will be available as-built and as upgraded with a sill stiffener. Both Plain Keystone and Shadow Keystone versions will be available with sill stiffeners. Completing the PRR decorating schemes are Merchandise Service cars as built in the 1940s and as upgraded later with sill stiffeners.



Walthers spring 2025 scheduled includes this Proto HO scale 50' AAR double door boxcar. Details on the transition-era model include Youngstown sliding doors, running boards, full height ladders, hand brakes mounted high on the end, and separately applied brake rigging.



REGISTER
(free)

[INDEX](#)

[TABLE OF CONTENTS](#)



Different Roadnumber Shown

Road names will include Santa Fe, Penn Central, Southern Pacific, Nickel Plate Road, Southern Railway, and Chicago, Burlington & Quincy.



Dreadnaught steel ends. The steam-era model features a ribbed steel roof, wood latitudinals and a wood running board.



Road names available on this release will be Santa Fe, Louisiana & Arkansas, Canadian National, Milwaukee Road, Frisco, and Illinois Central. A painted version with data only will provide a convenient base for hobbyists to decal the model for the railroad of their choice.

Walthers has announced plans to release a GP7 road switcher this summer. The HO scale Proto Series model will be available in eight road names plus an undecorated version. In addition to numerous road-specific details, features on all versions include wire grab irons, etched metal lift rings, and directional LED lighting.



GP7s decorated for Algoma Central will have a 36" dynamic brake fan on the long hood, a winterization hatch, Nathan M3 air horn and a whip antenna.



ATSF units will come with a Nathan MS1 air horn, can-style antenna, and etched metal sunshades above the cab windows.



have a whip antenna, Nathan M5 air horn and etched metal sunshades.



the cab windows, a firecracker antenna and all-weather windows on the engineer's side.

A boldly decorated Detroit, Toledo & Ironton GP7 will be fitted with a Nathan M3 air horn, sunshade above



CB&Q units will feature an operating Gyalight, firecracker antenna and sunshades.



GP7s decorated for NP and Wabash will have roof mounted air tanks including appropriate piping, 1,200 gallon fuel tanks and sunshades. The Wabash version will also have an operating Gyalight and a short MU

GP7s decorated for NP and Wabash will have roof mounted air tanks including appropriate piping, 1,200



All road names will have Pyle dual headlights except Rock Island which will have dual Mars headlights. DC versions will be available in this run as well as DCC units with a LokSound 5 decoder and a 28mm round speaker.





Also scheduled for release this summer is an HO scale 40' refrigerator car with wood sides and ends. The Walthers Mainline

Series model represents ice bunker reefers popular in the 1920s and 30s. Spotting features include 4' insulated swing doors, horizontal brake wheels mounted on vertical brake shafts, AB brakes, fishbelly underframes and Andrews plain-bearing trucks with machined metal wheelsets.



Decorating schemes on this release will be American Refrigerator Transit, NADX-Packerland Packing, URTX-Soo Line, Pacific Fruit

Express-Western Pacific, and two PFE-SP/UP schemes.



Completing Walthers summer 2025 release is a

68' Railgon gondola with see-through tie downs on the top chord and 100-ton roller-bearing trucks with 36" machined metal wheelsets. In addition to Montana Rail Link, road names for the Mainline Series model will be Arkansas-Oklahoma Railroad, BNSF, TILX, CSXT, Union Pacific, and Ferromex.

All Walthers HO scale models mentioned in this report come with Proto MAX knuckle couplers.

Info: www.walthers.com

N SCALE PRODUCT NEWS



Atlas has announced an N scale Berkshire 2-8-4 steam locomotive. The

model will be available as both a Gold Master product with a SoundTraxx Tsunami2 steam decoder and as a Silver Master product with an NMRA Next18 plug,



Road names in this release are Chesapeake and Ohio, Nickel Plate, Pere Marquette, and Wheeling and Lake Erie. Additionally, NKP 759, the Golden Spike Centennial Limited, will also be offered.



An Alco C424 locomotive in N scale featuring all-new tooling has been announced. The prototype was built between 1963 and 1966 as a competitor to the GE U25B and EMD GP35. 190 locomotives were built for roads in the US, Canada, and Mexico.



Road names in this first release are Canadian Pacific, Conrail (ex-EL), Delaware & Hudson, Erie Lackawanna, Green Bay & Western, Pennsylvania, and Reading.



Representing a Phase I C424, the Atlas model includes golden-white LED directional lighting, blackened metal wheels, and magnetic knuckle couplers. Gold models include a SoundTraxx Tsunami decoder while the Silver model includes an NMRA Next18 plug and speaker.



Atlas has announced a new run of MP15DC locomotives in N scale, now featuring ditch lights as appropriate. Road names and paint schemes for this run are BNSF H3, CSX YN3, FURX, Norfolk Southern, Reading, Southern Pacific, and Union Pacific.



The models include separately applied roof details and uncoupling levers. Silver sound-ready locomotives include a Next24



decoder plug and speaker, Gold models are equipped with a decoder capable of RailCom and RailCom Plus. Blackened metal wheels and AccuMate magnetic knuckle couplers are included.

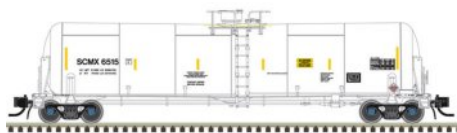

ASF Ride Control trucks with BLMA 36" metal wheels and separate brake details, the cars are available as singles and in multi-packs, both with and without buffer cars.

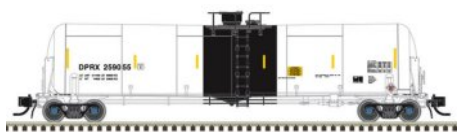

buffer cars include two BNSF 4180 Airslide hopper cars and four tank cars in Deep Rock Refining (DPRX), Valero Energy (VMSX) or Phillips Petroleum (PPRX). Multi-packs of six tank cars in the same road names are also part of this release.



A run of 4180 Airslide covered hoppers was also announced, with road names in the run including BNSF buffer service, Union Pacific (MP), Clinton Corn Processors (CCLX), GACX, Norfolk Southern, Rock Island, and Southern Pacific. The cars feature etched metal roofwalks and metal wheels.



New paint schemes and road numbers are part of a new run of N scale 55-ton fishbelly coal hoppers. New road numbers are available for Central Railroad of New Jersey, Delaware & Hudson, Norfolk Southern, Reading, and Western Maryland. New paint schemes available are Norfolk & Western and Norfolk & Western MOW.

A new run of 60' auto parts boxcars in N scale includes five new paint schemes and four paint schemes with new road numbers.



The new paint schemes are The Andersons (BAEX), Arkansas and Missouri, UP (ex-Rock), Southern, and

Norfolk & Western. New road numbers will be available in CSX, Detroit, Toledo & Ironton, Erie Lackawanna, and Union Pacific.



The models feature 70-ton roller-bearing trucks, a deluxe-style positionable door, AccuMate knuckle couplers, and roof overspray.

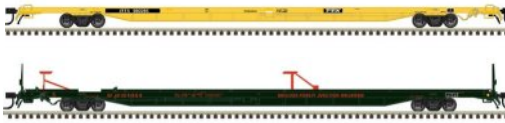

The last pre-order announcement in N scale is for ACF 89' 4" flat cars. Two different styles of car

are part of this release, one with container pedestals and one with mid/end hitches. Road names for the container cars are BNSF, Environmental Protection & Improvement Company (EPIX), Trailer Train (ITTX), and Redstreak (QUAX). Mid/end hitch car road names are Birillion & Forest Junction (BFJR), Ferrocarril del Pacifico (FCP), Maine Central (MEC), and Trailer Train (TTAX).

Pre-orders are due March 12, 2025 for an estimated 3rd or 4th Quarter 2025 arrival, depending on the product.

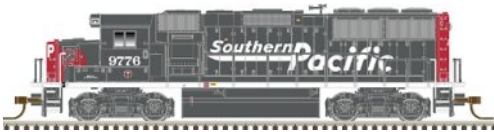

Atlas has released several new N scale Master Line models to its dealer network including a GP60

locomotive. Road names include Southern Pacific, Union Pacific, Denver & Rio Grande Western, Norfolk Southern, Texas Mexican, Green Mountain Railroad, and two BNSF schemes.

Also new from Atlas is an N scale model of a Fairbanks Morse H16-44 locomotive. The 1950s-era diesel is available decorated



[REGISTER](#)
(free)

[INDEX](#)

[TABLE OF CONTENTS](#)



Railroad, Southern Railway, and Union Pacific. For additional details on the Master Line H16-44 see the December 2022 issue of *MRH*.



The latest release of Atlas N scale locomotives includes a GP38 road switcher. The model is based on a prototype built by EMD from 1966 to 1971. Road names for the Master Line model include Central Maine & Quebec, Chicago & North Western, Conrail, FURX, Indiana Harbor Belt, Providence & Worcester, Rock Island, Norfolk & Western, and Southern Railway.



Atlas has completed another release of its modern Bombardier ALP-45DP dual-mode locomotive. The Master Line N scale model is available separately and in three-unit sets with a multilevel cab car and trailer car. Introduced by Atlas in 2012, the N scale ALP-45DP model features a non-operating pantograph that can be posed up or down. Decorating schemes include EXO, three NJ Transit schemes, and a special Atlas 100th Anniversary scheme. For additional details see the November 2023 issue of *MRH*. Atlas N scale Silver series locomotives are available for DC operations. DCC Gold series models come with a factory installed dual-mode ESU LokSound decoder.



New Atlas N scale rolling stock just released to dealers includes a Trinity 64' reefer. Note that the 64' dimension is inside the car while the overall outside length of the big reefer is 75'. The Master Line model is produced from tooling

originated by BLMA. Road names include Tropicana, Cedar Grove Logistics, and several Union Pacific schemes. For additional details see the September 2023 issue of *MRH*.

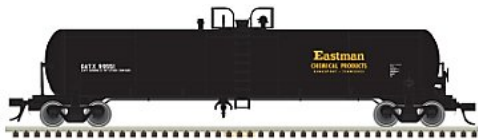

Completing Atlas's latest release of N scale models is a GATX 20,700 gallon tank car. The Master Line model is

available decorated for GATX- CF Industries, GATX-Eastman Chemical, CATX-Ozone Waters, CRCX-Calumet Refining Co., and Mobay Chemicals.

Info: shop.atlasrr.com



Bowser is taking pre-orders for 70-ton 2-bay covered hoppers in N scale. The cars will feature a one piece molded plastic body with a

separate underframe and detail parts such as the brake wheel, air tank, brake cylinder, triple valve, and grab irons. The cars will also be equipped with knuckle couplers and metal wheels.



Road names in this first release are ATSF, Central Soya, C&O, DT&I, Great Northern, Haliburton, Lehigh & New England, MKT, Nickel Plate Road, Southern Pacific, Southern, and Union Carbide.



As well as the 70-ton 2-bay covered hoppers, Bowser has also announced a 70-ton 2-bay ballast car in N scale. Constructed similarly

to the covered hoppers, the models differ in the dump gate style and most of the roof missing on the ballast cars.



Road names for the ballast cars are ATSF, Burlington Northern, CNW, Conrail (both Yellow and Gray), CSX, D&RGW, Maine Central, Ontario

Northland, Penn Central, and Reading & Northern.

Info: bowser-trains.com



R. Bale

PRR 4-8-2 M1 CLASS STEAM LOCOMOTIVES

The 4-8-2 Mountain-type steam locomotive was introduced by the Chesapeake & Ohio Railroad in 1910. Observing that several railroads were having success with the 4-8-2 wheel arrangement, the Pennsylvania Railroad built a test locomotive in its Altoona shops in 1923. It had 72" drivers and received the M1 classification. Like most PRR steam locomotives, the M1 and M1a featured a square Belpaire firebox. After three years of testing, production orders for 200 were split between locomotive builders Baldwin and Lima. In 1930 PRR ordered 100 more M1 locomotives. A significant improvement was incorporating the cylinder block and smokebox saddle in a single casting. Identified as class M1a, PRR's new 4-8-2 locomotives were intended for passenger as well as freight service with some receiving decorative gold-leaf on the tender and cab sides. In service the M1a proved better suited to hauling freight. M1b versions of the PRR 4-8-2 had additional firebox circulators with the only external visual difference being extra cleaning plugs on the side of the firebox to service the circulators. During later years some M1s were given sixteen-wheel 210-F-75B tenders almost as long as the locomotives themselves. All of the tenders were fitted with scoops to pick up water from track pans. On the rear tender decks, all were later fitted with doghouses for the head-end brakeman, giving him a view backward over the train. Like many PRR locomotives, most M1s had trainphone antennas added during the 1940s.

Get more articles like this

GIVE IT A LIKE





Broadway Limited has scheduled an April release for N

scale models of Pennsylvania Railroad class M1a and M1b 4-8-2 steam locomotives. The model features a hefty cast superstructure mounted on a diecast chassis with numerous separately applied details including handrails, ladders, grab irons, piping, and a bell and whistle.



Multiple road numbers, as well as painted but

unlettered models, will be available for both the M1a and M1b versions of the steam locomotive. Two PRR-style fantasy lettering schemes that never appeared on the M1 prototype will also be available.

Operating systems include a choice of standard DC or DCC featuring Paragon4 Sound with Rolling Thunder and capacitance circuitry to improve operation on imperfect track.



Broadway Limited is booking reservations through July 10, 2025 for Baldwin RF16 locomotives with availability

planned for spring 2026. The N scale model replicates the distinctive Shark nose diesels Baldwin built in the early 1950s.



BLI will offer A and B units singly and in paired sets decorated for Pennsylvania Railroad, Baltimore & Ohio and New York Central. A-units decorated for Delaware &

Hudson will also be available.



In A-B paired sets, the B-unit will be unpowered. All RF16 A-units will come with Paragon4 Sound/DC/DCC system. Stealth models



(DC, no sound, DCC-ready) will also be available in this release. The order deadline is July 10, 2025, with an estimated delivery of the spring of 2026.

Info: www.broadway-limited.com



KatoUSA plans to reissue its N scale Santa Fe Super Chief starter set this summer. The set will include a Santa Fe EMD F-unit in Warbonnet

paint, a sleeper, diner, observation car, an oval of Kato Unitrack and a Kato SX power pack. The round-end observation car will have an illuminated taillight.



KatoUSA has released its N scale EMD switcher in seven new road names. The locomotives come with directional golden white LED headlights and illuminated preprinted number boards. They will

be equipped with body-mounted Kato magnetic knuckle couplers.



Road names on this limited release include Santa Fe, Burlington Northern, Union Pacific, Western Pacific, Atlantic Coast Line, Canadian National, Frisco, Grand Trunk Western, Kansas City

Southern, and Seaboard Airline. Kato's NW2s will be delivered ready for DC operation. They are DCC-ready for aftermarket DCC decoders such as Digitrax DN123K3 or Train Control Systems K3D3.

Kato's development team is currently working on an all-new version of an N scale EMD SD70ACU; a unique locomotive rebuilt by Norfolk Southern and Progress Rail. The prototype

engine started life as an EMD SD90MAC that was later upgraded electrically by swapping out the Siemens tech with Mitsubishi components. The original cab was replaced with the SD70ACe's cab. Additional information including photos of pre-production samples are expected later this year.

Info: www.katousa.com



New N scale models from **Micro-Trains Line** include this 40' Western Pacific boxcar. The model is based on a prototype built by Pullman-Standard in 1951. The model is available in a 2-pack with both cars weathered.



Also new from Micro-Trains is this 50' Procor general service tank car.



This Santa Fe 36' class CE-1 riveted steel caboose follows a prototype built in the late 1960s. Micro-Trains new N scale version represents a caboose upgraded and repainted in

the early 1980s.

Info: Contact a dealer

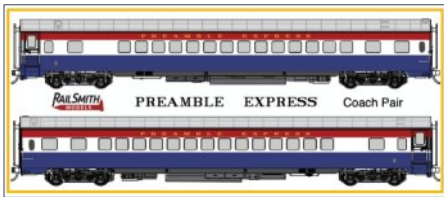

RailSmith has announced the planned release in 1st Quarter of 2026 of the Preamble Express coach pair in N scale. Making up half of the cars in the train that traveled the

United States in 1974 to test the American Freedom Train route, the coaches will be 'classic versions' of the cars.

Info: lowellsmith.net



REGISTER
(free)

[INDEX](#)

[TABLE OF CONTENTS](#)



ScaleTrains has announced a second run of SD40T-2 locomotive models in N

scale. Featuring see-through tunnel motor grills, the model will be available in multiple paint schemes for Rio Grande, Southern Pacific, and Union Pacific. Different length noses and ditchlights will be available as appropriate for the prototype.

The models, part of the Rivet Counter line, include road number specific details and paint schemes. They are equipped with all-wheel electrical pickup, all-wheel drive, factory applied wire grab

irons, windshield wipers, and trainline hoses with silver gladhands. DCC and sound equipped models include an ESU LokSound 5 DDC and sound decoder and a single cube-type speaker. DC/DCC ready locomotives include an E24 connector.

Info: scaletrains.com



Trainworx has announced a special run of N scale PS 4427 covered hoppers. Equipped with Fox Valley metal wheels and

Trainworx M89 couplers, the models are available in three paint schemes, JW Flammer Co., Inc., Terminal Grain, and I.H. French & Co. Each paint scheme has three road numbers available.

Info: www.train-worx.com/?s=TLDX

NEW STRUCTURES & SCENIC SUPPLIES



Athearn has announced plans to release a selection of 40' high-cube containers in September 2026. Both HO and N

scale versions of the containers will be available.



Decorating schemes will include Hede Shipping, Mediterranean Shipping Co., Triton, GE Sea Co., Textainer,

Hatsu Marine, CMA CGM and CULINES. The models will be available in 3-packs with each container individually numbered. Info: www.athearn.com

New items available now from **Atlas** include N and HO scale standard height corrugated containers. Features include corrugated ends and 1-1 door styles with OTI handles.



The models are available in 3-packs with each container individually numbered.



N and HO scale containers in are available decorated for Evergreen, K-Line and Zim. HO scale containers are also available for NYK Line, OOLU, and United Arab Shipping.



Atlas Master 45' Pines Trailers in HO and N scales are available for pre-order. Paint schemes

in this run include Montgomery Ward, National Piggyback Service, GLKZ ex Redon, Generic Lease, Neshanic Trailer Company, Norfolk & Western, and Southern Pacific.

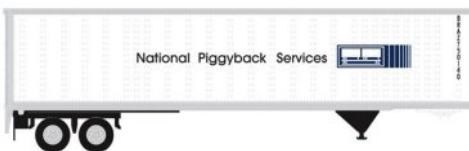

Models include two sets of landing gear, fully extended or retracted, hinges and latches, and rear bumper detail.



REGISTER
(free)

[INDEX](#)

[TABLE OF CONTENTS](#)



Also available for pre-order are 1993 Ford Explorers in HO and N scale.

Including a simulated rotary beacon, side view mirrors, simulated rubber tires, and interior detail, they are sold in sets of two. Paint schemes include BC Rail, BNSF Police, Montana Rail Link, Norfolk Southern, Ontario Northland, Reading & Northern, Wisconsin Central, and Union Pacific RR Police.

Info: shop.atlasrr.com



Inter-Action Hobbies has released a model of a Fairmont M19 Railroad speeder in HO, S, & O scales. An open air, gasoline powered replacement for hand cars, they were widely used for railroad inspections and maintenance until Hy-Rail vehicles replaced

them. Single-piece 3D resin prints, the models come unpainted and two to a kit. The non-operating model includes waterslide decals and assembly instructions.

www.interactionhobbies.com



Mine Mount Models has announced the availability of Pier 7 Food & Fuel in HO scale. Part of the Echo Point Harbor series, the model is a laser cut structure with resin details and shake shingles. Designed to be built in different configurations, the size can vary but the basic kit occupies an area 4.5" x 11.5".

Info: minemountmodels.com

Minifer has announced a new laser-cut cardboard and wood kit based on a house located in Gap, France. Designed in the Art Deco style in 1936, similar designs can be found in many locations around the world. The assembled model's



dimensions are 5.11" x 5.11" x 3.14". The instructions are 22 pages long, largely of construction photos, and can be downloaded from the website. Some use of Google Translate may be necessary for modelers unfamiliar with French.

Info: www.minifer.fr/en



miniprints has introduced a set of 25 telegraph pole cross arms with five glass insulators. The 3D printed cross arms are printed in clear resin and require painting. Poles are not included. The cross arms are available in N, HO, S and O scale.



In a humorous vein, miniprints has released a figure titled Ministry of Silly Walks, based on the character created by John Cleese in the famous Monty Python skit. The 3D printed figure is available painted or unpainted in N, HO, S, and O scales.



Also new from miniprints is a Fairmont M19 speeder with a figure of Buster Keaton on board. The whimsical scenic item is based on the 1965 movie The Railrodder. This is a static model with the wheels cast into the model. It is not an operational vehicle. It is available painted

or unpainted in HO, S and O scales.

Info: www.miniprints.com

Monster Model Works has released a new HO scale craftsman kit for two commercial brick store front buildings named Edmunds Hardware Co & The Olde Tavern Inn. Measuring just



REGISTER
(free)

[INDEX](#)

[TABLE OF CONTENTS](#)

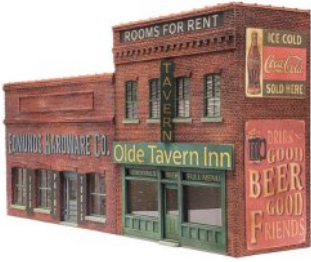

.125" deep, the kit can be assembled as two separate buildings or as a single structure 9.625" wide. Components include 3D laser-engraved aged American Brick sides and corners, 3D laser-engraved Terra Cotta coping, laser-cut storefronts and signs, peel & stick windows and doors and a sheet of signs. Assembly and painting are required.

Info: www.larkspurlaserart.com

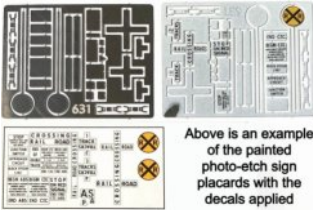

Above is an example of the painted photo-etch placards with the decals applied

Showcase Miniatures is selling an N scale kit for common railroad safety signs. The kit consists of photo-etched support structures and appropriate decals.

Info: www.showcaseminatures.net



Walthers has introduced kits for a group of five small commercial structures that can be used individually or placed in a row in a

shopping center. The plastic molded kits feature easy press-fit assembly. They are molded in four colors or can easily be repainted and resigned for a variety of businesses. In addition to Best Hobby and Dough'n Joe shown here, similar kits are available for The Book Shop, Tony's Pizza, and Pampered Paws. Each building has a footprint of 4.187" x 2.187". The tallest is 3.125" high. Availability is scheduled for spring 2025.

Info: www.walthers.com



Woodland Scenics has introduced new HO scale dog and

cat groups to its growing list of small hand-painted animal models. The Dog Pack contains nine different canines of various breeds in sniffing, walking and sitting positions.



The Cat and Dogs group contains eight different dogs and one

black cat. The canines are walking, playing with a ball and laying down. The cat is on high alert with this many dogs around.

Info: www.woodlandscenics.com

NEW DECALS, SIGNS AND FINISHING PRODUCTS



Great Decals has released a new N scale lettering set for a Canadian National 36' Fowler boxcar with 6' doors.

Info: www.ebay.com/itm/126871604386?mkcid=16&mkevt=1&mkrid=711-127632-2357-0&ssspo=svnD02QfSGm&sssrc=2047675&ssuid=svnD02QfSGm&widget_ver=artemis&media=EMAIL

DISCLAIMER

The opinions expressed in this column are those of the writer and do not necessarily reflect the opinion of Model Railroad Hobbyist or its sponsors. Every effort is made to provide our readers with accurate and responsible news and information, however, neither Model Railroad Hobbyist or the writer of this column can be held responsible for any inaccuracies or typographical errors that may inadvertently appear in this column.



REGISTER
(free)

[INDEX](#)

[TABLE OF CONTENTS](#)

Make it run like a

Dream TRACKWORK BOOK

104 pages

By Joe Fugate

PRE-SPRING
SPECIAL

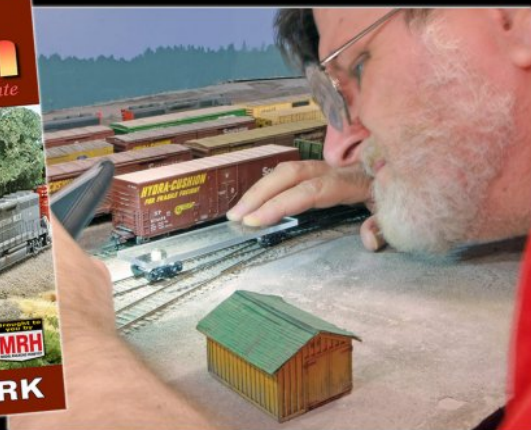
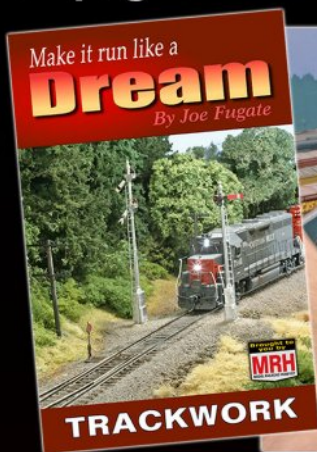

Available from the MRH Store: store.mrhmag.com

"The new bible of track laying." - L.T.

"Chapter 3 alone is worth the cover price." - B.M.

"A lot of info ... copiously illustrated.." - J.A.

Click me to

Get eBook NOW >>

~~\$14.99~~ \$9.49

Format: Landscape and Portrait
PDF

Click me to

ORDER PAPERBACK >>

~~\$31.99~~ \$27.99

FREE shipping in US!
Foreign shipping 50%

Other books in this series: ROLLING STOCK (available now) and LOCOS (Q2 2025)

MRHMAG.COM

[INDEX](#)

[TABLE OF CONTENTS](#)



BRIEFLY NOTED AT PRESS TIME ...

Officials from the 57th annual **Amherst Railway Show**, held late last month in West Springfield MA, report a record high attendance of 27,535 ...

Athearn has cancelled several previously announced projects due to insufficient preorders. N scale cancellations include F89-F bi-level auto racks and bay window cabooses. Cancelled HO scale models include 20' corrugated containers and Ford C telesquirt firetrucks ...

Fred Hill, owner of The Original Whistle Stop in Pasadena CA, reports that among the more than 15,000 residences destroyed by the Pacific Palisades and Eaton/Altadena fires near Los Angeles last month, he is aware of 89 model railroaders and three collectors who lost everything ...

Kadee is preparing to increase prices on most of its products. The announcement did not include any specifics or effective date for the pending changes ...

Future HO scale items coming from **Walthers** include a Proto scale test car, 85' Viewliner sleepers, a Plymouth ML-8 switcher and a 40' double-sheathed wood boxcar with Murphy ends. *MRH* will have full details next month ... ■

Get more articles like this

GIVE IT A LIKE



REGISTER
(free)

[INDEX](#)

[TABLE OF CONTENTS](#)

SELECTED EVENTS



Model Railroad Hobbyist | February 2025

FEBRUARY

Please check with any organization hosting an in-person event for the latest status of the event.

Ongoing 2025

ONLINE, Zoom, dates vary, see website. Operation Special Interest Group Meetups – limited attendance available.

Info: www.opsig.org/Virtual

Archive: www.youtube.com/c/OperationsSIG

ONLINE, Zoom & YouTube, Wednesday & Saturday, see Facebook page. “New Tracks” Meetup, hosted by Jim Kellow, MMR.

Info: newtracksmodeling.com

YouTube: www.youtube.com/channel/UCMA_VhPb5pjdkAYTdXLceJA

ONLINE, Facebook & YouTube, dates vary, see Facebook page. “NMRAX” organized by Gordy Robinson, Martyn Jenkins, Speed Muller, Jordan Kramer.

Info: www.facebook.com/groups/nmragroup

ONLINE, YouTube, every other Saturday. 4th Division, Pacific Northwest Region, NMRA hosts online layout tours and clinics.

Archive: www.youtube.com/c/4DPNRMovies

ONLINE, YouTube, March 17-20, 2025. NMRA Northeastern Region NERx annual virtual convention. www.youtube.com/c/NMRAORGMModelRailroading

Info: nerx.org

ONLINE, Zoom, Second Tuesdays, 8pm Eastern. "Off the Beaten Track" featuring Narrow Gauge layouts, clinics, and manufacturers.

Info: groups.io/g/NNG

AROUND THE USA, IN-PERSON, Various dates. ScaleTrains.com Road Trip.

Info: www.scaletrains.com/roadtrip

February – March 2025

ALABAMA, MOBILE, March 8, 2025. Southwest Alabama Railroad Modelers (SWARM) Model Train Show. Mobile Via Health, Fitness and Enrichment Center, Arlene F. Mitchell Campus, 1717 Dauphin Street.

Info: gasamuel@aol.com

(HYBRID) CALIFORNIA, SAN LUIS OBISPO, March 27-30, 2025. Daylight Limited – Pacific Coast Region Convention. Embassy Suites by Hilton San Luis Obispo, 333 Madonna Road.

Info: pcr2025.org

COLORADO, COLORADO SPRINGS, February 22-23, 2025. The Train Expo Colorado (TECO). Colorado Springs Event Center, Hall B, 3970 Palmer Park Blvd.

Info: tecoshow.org

GEORGIA, MACON, March 28-29, 2025. Central Georgia RPM. Lundy Chapel Church, 2081 Forest Hill Rd.

Info: www.centralgarpm.com

ILLINOIS, CALLEDONIA, March 2, 2025. Rock River Valley Division Monthly Meeting/Clinics. Paulsons Agricultural Museum, 6950 Belvedere Rd.

Info: rrvd-nmra.org



REGISTER
(free)

[INDEX](#)

[TABLE OF CONTENTS](#)

ILLINOIS, MACHESNEY PARK, March 29-30, 2025. 2025 Rock River Valley Train Show, sponsored by the Rock River Valley Division. Harlem High School, 9229 Alpine Rd.

Info: rrvd-nmra.org/event/rock-river-valley-train-show

INDIANA, NAPPANEE, March 15, 2025. 20th Annual Elkhart Model Railroad Club Train Show. Claywood Event Center, 13924 N 1100 W (County Line Road).

Info: www.emrrc.com

MINNESOTA, PLYMOUTH, March 14-15, 2025. 8th Annual Twin Cities Division, NMRA Modelers Retreat. Mount Olivet Lutheran Church, 12235 Old Rockford Rd.

Info: tcdnmra.org/modelers-retreat

NEW YORK, ROCHESTER, March 1-2, 2025. Rochester Model Club Annual Open House and Equipment Sale. 150 South Clinton Avenue.

Info: www.rocmrrc.com

OHIO, CANFIELD, February 15, 2025. Canfield Train & Toy Show. Michael Kusalaba fund of the Youngstown Foundation, Event Center, Canfield Fairgrounds, Gate 9 St Rte 46.

Info: www.facebook.com/canfieldtoyandtrainshow

OHIO, WEST CHESTER (Cincinnati Area), March 15, 2025. 2025 Annual Division 7 NMRA Spring Model Train Flea Market. Lakota West Freshman Campus, 5050 Tylersville Rd.

Info: cincy-div7.org

OHIO, WOOSTER, March 15, 2025. Wooster Train & Toy Show. Wayne County Fairgrounds Event Center.

Info: www.facebook.com/events/2105028099952980

OREGON, EUGENE, February 15-16, 2025. 36th Annual Model Railroad Swap Meet & Train Show, sponsored by Willamette Cascade Model Railroad Club. Lane Event Center, 796 West 13th Avenue.

Info: www.facebook.com/events/1014615623750734

OREGON, PORTLAND, March 8, 2025. Willamette Model Railroad Club Annual Swap Meet. Kliever Armory, 10000 33rd Avenue.
Info: wmrrc.com

PENNSYLVANIA, YOUNGWOOD, March 21-22, 2025. RPM-EAST Railroad Prototype Modeler Seminar. Westmoreland County Community College Student Achievement Center, 145 Pavilion Lane.
Info: www.hansmanns.org/rpm_east

TEXAS, PASADENA (Houston), February 15, 2025. Greater Houston Train Show, presented by the San Jacinto Model Railroad Club. Pasadena Convention Center, 7902 Fairmont Parkway.
Info: sanjacmodeltrains.org

UTAH, OGDEN, February 28, March 1-2, 2025. The Hostlers Model Railroad 2025 Festival. Ogden Union Station, Historic 25th Street & Wall Avenue.
Info: www.hostlers.info

VIRGINIA, CLIFTON FORGE, February 22-23, 2025. 2025 George Washington Train Show, sponsored by the Chesapeake & Ohio Historical Society. C&O Railway Heritage Center, 701 Main Street and Clifton Forge Armory, 724 Commercial Ave.
Info: www.facebook.com/events/592870870059396

WASHINGTON, SPOKANE, March 9, 2025. Spokane Spring Model Train Show. Spokane County Fair & Expo Center, 404 N. Havana St.
Info: shirleysample13@gmail.com

WISCONSIN, MADISON, February 15-16, 2025. 57th annual Mad City Railroad Show, Exhibition Hall, Alliant Energy Center.
Info: www.nmra-scwd.org

Future 2025 by location

AUSTRALIA, QUEENSLAND, BRISBANE, August 22-24, 2025. Brisbane 2025, NMRA Australasian Regional Convention. Flight One, Qantas Drive, Archerfield.
Info: nmra.org.au/nmra-ar-convention-2025



REGISTER
(free)

[INDEX](#)

[TABLE OF CONTENTS](#)

CANADA, ONTARIO, BURLINGTON, October 17-19, 2025. Real Rails 2025 Convention, sponsored by the Canadian Pacific Historical Association. Holiday Inn and Candle Wood Suites, 3060 South Service Road.

Info: www.cptracks.ca/realrails2025.html

CANADA, ONTARIO, HAMILTON, April 25, 2025. Steel Town RPM, sponsored by the HO Model Engineers Society. Eva Rothwell Centre, 460 Wentworth St N.

Info: steeltownrpm.wordpress.com

CANADA, ONTARIO, PRESCOTT, April 12, 2025. 2nd Annual Prescott Model Train Show sponsored by the Prescott Model Railway Group. Leo Boivin Community Centre, 444 Prince Street.

Info: www.facebook.com/PrescottRailroadModelClub

NEW ZEALAND, MOSGIEL, May 3-4, 2025. Dunedin Model Train Show. Taieri Bowling Club, 12 Wickliffe Street.

Info: dunedinmodeltrainshow@gmail.com

COLORADO, DURANGO, May 15-18, 2025. NMRA Rocky Mountain Regional Convention. Durango Doubletree, 501 Camino Del Rio.

Info: www.rmr-nmra.org/2025%20Convention/Home.html

ILLINOIS, CALLEDONIA, April 2, May 4, 2025. Rock River Valley Division Monthly Meeting/Clinics. Paulsons Agricultural Museum, 6950 Belvedere Rd.

Info: rrvd-nmra.org

ILLINOIS, COLLINSVILLE (St. Louis, MO). July 24-26, 2025. St. Louis Railroad Prototype Modeler Meet. 1 Gateway Center Drive.

Info: stlrpm.com

LOUISIANA, BATON ROUGE, June 26-29, 2025. Blues Express 2025, NMRA Lone Star Regional Convention. Holiday Inn Baton Rouge South, 9990 Airline Way.

Info: bluesexpress2025.com

MAINE, TOPSHAM, April 26, 2025. 2025 Great Falls Model Railroad Club Train Show. Mt. Ararat High School, 68 Eagles Way.

Info: www.greatfallsmodelrrclub.org/events/event/2024-gfmrrc-train-show

MASSACHUSETTS, SPRINGFIELD, May 30-June 1, 2025. New England/Northeast RPM, in association with the Amherst Railway Society. Springfield Sheraton Monarch Place, One Monarch Place.

Info: nerpm.org

MINNESOTA, WILMAR, May 15-18, 2025. 2025 NMRA Thousand Lakes Region Convention. Location TBD.

Info: www.thousandlakesregion.org/blank

MINNESOTA, WOODBURY, April 26, 2025. Newport Model RR Train Flea Market. Woodbury High School, 2665 Woodland Dr.

Info: www.newportclub.us

MICHIGAN, NOVI, July 14-19, 2025. Station No. VI, 2025 NMRA National Convention. Sheraton Hotel, 21111 Haggerty Road.

Info: nmra2025.com

NEW HAMPSHIRE, NORTH SUTTON, April 13, 2025. 8th Dartmouth/Lake Sunapee Region Model Railroad Show.

Kearsage Regional Middle School, 32 Gile Pond Rd.

Info: cvrr.railfan.net/cvmrr

NORTH CAROLINA, HIGH POINT, May 3-4, 2025. RPM Carolinas: School of Railway Prototype Modeling. 4050 Premier Drive.

Info: www.facebook.com/groups/1895473627515807

OHIO, DUBLIN (Columbus), May 15-18, 2025. The Buckeye Express, NMRA Mid-Central Regional Convention. Dublin Embassy Suites, 5100 Upper Metro Pl.

Info: buckeyeexpress.div6-mcr-nmra.org/Main.html

OREGON, CHILOQUIN, June 14-29, 2025. Train Mountain Triennial 2025. Train Mountain Railroad Park, 36941 South Chiloquin Road.

Info: trainmountain.org

OREGON, ELSIE, April 5, 2025. Pacific Model Loggers' Congress. Camp 18 Restaurant and Logging Museum, 42362 US Hwy 26.

Info: pacificmodelloggerscongress.org



PENNSYLVANIA, MOUNT UNION, July 18-20, 2025. Central Pennsylvania Shortlines RPM. Bricktown Museum, 300 W. Small St.
Info: rpm.pennsyrr.com

TENNESSEE, GATLINBURG, September 17-20, 2025. Smoky Mountain Rails Convention, sponsored by the Southeastern Region of the NMRA. Glenstone Lodge, 504 Airport Rd.
Info: 2025serconvention.org

TENNESSEE, JOHNSON CITY, May 30-31, 2025. George L. Carter Railroad Museum Inc. Big Train Show. ETSU Mini-Dome on the East Tennessee State University Campus.
Info: johnsoncityrailroadexperience.org

WASHINGTON, PASCO, May 9-11, 2025. The Ainsworth Connector, NMRA Pacific NW Regional Convention, Red Lion Hotel, 2525 N 20th Ave.
Info: pnr5d.org/pnr-5th-division-home-page/2025-pnr-convention ■



Did you see this article?

in the **FEBRUARY 2025 MRH RUNNING EXTRA!**

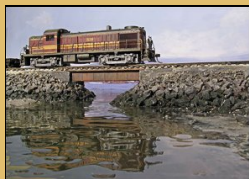

Modeling water with self-leveling epoxy

Get full eBook now ▶

← click here



Each eBook has 80-100 pages

RUNNING ##### **EXTRA**

GREENBRIER TRANSVERSE COIL CAR

HO
SCALE



**ORDER DEADLINE:
FEBRUARY 17TH**



RAPIDO

CLICK HERE



REGISTER
(free)

[INDEX](#)

[TABLE OF CONTENTS](#)

CLICKABLE ADVERTISER INDEX

[Accu-Lites](#)
[Atlas Model Railroad Co.](#)
[Bachmann](#)
[Berrett Hill Trains](#)
[Black Cat Publishing](#)
[Blair Line](#)
[Crew Call with Mike Rose](#)
[Digitrax \(2 page spread\)](#)
[DVL Design LLC](#)
[East Coast Circuits](#)
[ESU LokSound](#)
[Fast Tracks](#)
[Great Decals](#)
[Inter-Action Hobbies](#)
[Iowa Scaled Engineering](#)
[Logic Rail Technologies](#)
[Masterist Scale Railroad Models](#)
[Model Railroad Control System](#)
[Model Rectifier Corporation](#)
[Monashee Laser Engineering](#)
[Monroe Models](#)
[MRH Store \(1\)](#)
[MRH Store \(2\)](#)
[MRH Store \(3\)](#)
[MRH Store \(4\)](#)
[MRH Store \(5\)](#)
[Mt. Albert Scale Lumber](#)
[NCE \(2 page spread\)](#)
[2025 NMRA National Convention](#)
[North American Railcars \(PWRS\)](#)
[Northwestern Scale Models](#)
[Pre-Size Model Specialities](#)
[Precision Design Co.](#)
[Proto87.com](#)
[Rapido \(1\)](#)
[Rapido \(2\)](#)
[Ring Engineering](#)
[Rock Island Hobby](#)
[Roomettes](#)

[Ron's Books](#)
[Scale Trains](#)
[Sceniking.com](#)
[Southern Digital](#)
[St. Louis Railroad Prototype Modelers Meet](#)
[Streamlined Backshop](#)
[TAM Valley Depot](#)
[Train Control Systems \(TCS\)](#)
[TrainMasters.tv \(1\)](#)
[Trainworld.com](#)
[Westerfield](#)

Did you see this article?

in the **FEBRUARY 2025 MRH RUNNING EXTRA!**



Model a Boston & Albany 36' boxcar

Get full eBook now ▶

click here

MRH **RUNNING**
EXTRA

Each eBook has 80-100 pages

Clickable "other" index
[Other – Contents](#)
[Other – Cover](#)
[Other – MRH Marketplace](#)
[Other – MRH Sponsors](#)

Coming next month in MRH ...

Brian Morgan's GN Seattle Terminal line layout tour ...



Atlas Roco S2 full DCC conversion ...

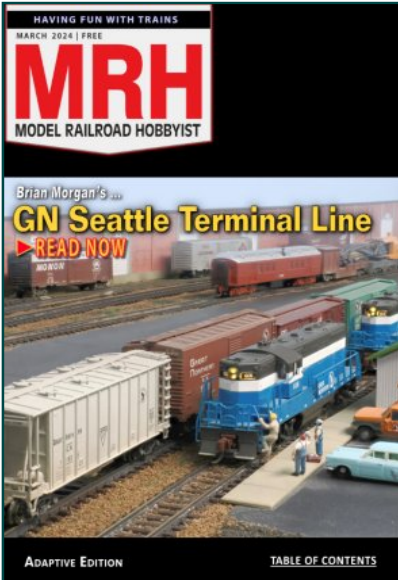
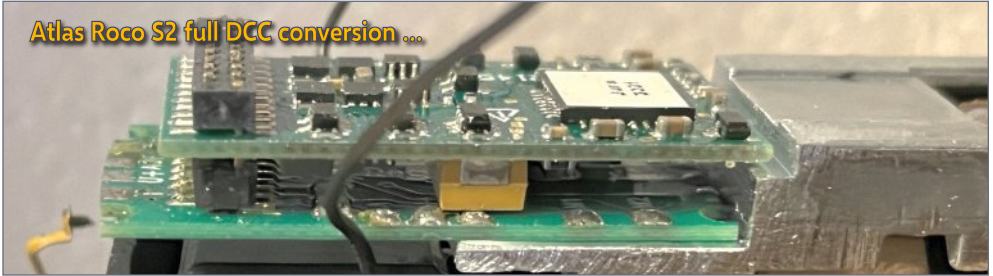

Newbie to ops tells his story ...

... coming March 15th in the
March MRH



REGISTER
(free)

[INDEX](#)

[TABLE OF CONTENTS](#)

Coming next month in Running Extra ...

... all the MRH articles and ads, PLUS:

Thom Driggers upgrades an ALCO brass C-855a ...

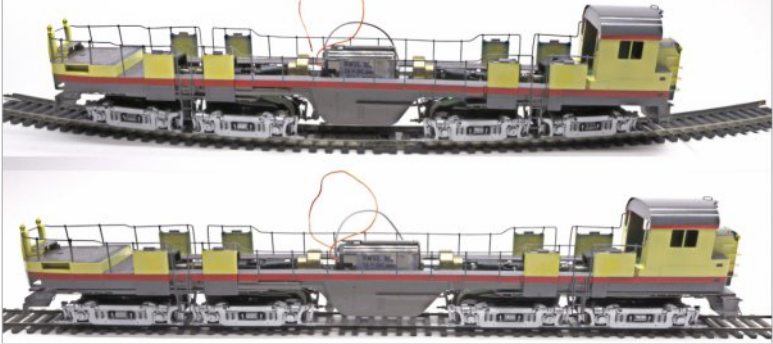

Make this cool under-rail tie cutter ...



March 2025 - \$2.99

MRH **RUNNING**
EXTRA
Apprentice with savvy modelers

Thom Driggers on ...
Upgrading an ALCO brass C-855a
▶ **READ NOW**



THE PROTOTYPE



Also these articles:

- Lorem ipsum dolor sit amet
- Consectetur adipiscing elit morbi
- Vestibulum tempus vehicula
- Mauris tempor libero ipsum pellentesque
- Nullam porta ut arcu at lobortis

... and much more!



Poor man's paint spray booth ...

... all this and much more!

SUBSCRIBE AND SAVE UP TO 80%