

HAVING FUN WITH TRAINS

APRIL 2020 | FREE

# MRH

MODEL RAILROAD HOBBYIST

## ALSO:

- Modeling with digital calipers
- Walthers track cleaning car upgrade
- Designing a layout ops plan
- All about DCC decoder connectors

*... and more inside!*

## Joe Visintine's East Bluff Terminal

▶ READ NOW



PORTRAIT EDITION



DOWNLOAD



REGISTER  
*(free)*

AVAILABLE FOR PRE-ORDER FROM



# MASTER N & HO TRINITY 64' REEFERS



CIT Group/Capital Finance



Union Pacific "ARNM" (High Numbers)

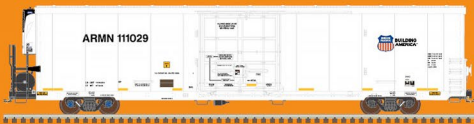

Union Pacific (High Numbers)



Naked Juice

**Reserve Yours by May 13th!**



Tropicana

**CLICK  
HERE**

ATLAS MODEL RAILROAD CO., INC. • 378 Florence Ave., Hillside, NJ 07205 • [www.atlasrr.com](http://www.atlasrr.com)

# STAFF

HAVING FUN WITH TRAINS

**MRH**  
MODEL RAILROAD HOBBYIST

Model Railroad Hobbyist April 2020 | #122

(Updated 04/03/20)

## Editorial Staff



Joe D. Fugate, Publisher and Editor



Patty Fugate, Pasteup and Layout



Richard Bale, News and events



Jeff Shultz, News and events, Tech Assistant



Joe Brugger, Copy Editing



Mike Dodd, Copy Editing



**RATE THIS ISSUE**

ISSN 2152-7423

## Advertising

Les Halmos, Account Manager

Jean-François Delisle, Marketing Assistant

## Regular contributors

Eric Hansmann, Editor-at-Large

Jim Six, Limited Modeler column

Ken Patterson, Reporter-at-Large

## Rotating Columnists

Jack Burgess, Getting Real column

Marty McGuirk, Getting Real column

Nick Muff, Getting Real column

Mike Rose, Getting Real column

Tony Thompson, Getting Real column

Rob Clark, Imagineering

Dave Meek, Imagineering

Ray Dunakin, Imagineering

Issue password: Apr2020

Published for the glory of God. [What's this?](#)

# MRH SPONSORS



Model Railroad Hobbyist | April 2020

## A - L



[acculites.com](http://acculites.com)



[railroadhobbyshow.com](http://railroadhobbyshow.com)



[archertransfers.com](http://archertransfers.com)



[athearn.com](http://athearn.com)



[www.atlasrr.com](http://www.atlasrr.com)



[bachmanntrains.com](http://bachmanntrains.com)

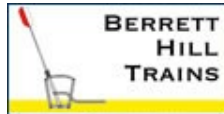

[berrethill.com/trains](http://berrethill.com/trains)



[blairline.com](http://blairline.com)



[coffmaneng.com](http://coffmaneng.com)



[deluxematerials.co.uk](http://deluxematerials.co.uk)



[www.digitrax.com](http://www.digitrax.com)



[trackplanning.com](http://trackplanning.com)



[esu.eu/en](http://esu.eu/en)



[handlaidtrack.com](http://handlaidtrack.com)



[iascaled.com](http://iascaled.com)



[litchfieldstation.com](http://litchfieldstation.com)

[Vendors: Get your clickable logo on these pages ...](#)

# MRH SPONSORS | 2

## M - Z



[micro-trains.com](http://micro-trains.com)



[store.mrhmag.com](http://store.mrhmag.com)



[ModelTrainTechnology.com](http://ModelTrainTechnology.com)



[www.modelrectifier.com](http://www.modelrectifier.com)



[handlaidtrack.com/mt-albert-scale-lumber](http://handlaidtrack.com/mt-albert-scale-lumber)



[ncedcc.com](http://ncedcc.com)



[www.pwrs.ca/main.php](http://www.pwrs.ca/main.php)



[rapidotrains.com](http://rapidotrains.com)



[ringengineering.com](http://ringengineering.com)



[roometteslighting.com](http://roometteslighting.com)



[scaletrains.com](http://scaletrains.com)



[sodigi.com](http://sodigi.com)



[sbs4dcc.com](http://sbs4dcc.com)



[tamvalleydepot.com](http://tamvalleydepot.com)



[trainfest.com](http://trainfest.com)



[walters.com](http://walters.com)

Looking for something? Check the MRH Marketplace!

The screenshot shows the MRH Marketplace website with several advertisements. Key items include: 'INTERACTIVITY' for model vehicles, 'WEATHERING POWDER MONROE' for model weathering, 'NEW KIT: AT&SF Fe-Q Fe-Fe-V' by Westfield Models, 'CROW FEWER PRODUCTS' for model accessories, 'PRECISION DESIGN CO.' for custom etchings, and 'MORNINGSTAR' for model supplies. Navigation links for 'MRH MAG.COM', 'INDEX', and 'TABLE OF CONTENTS' are visible at the bottom.

Take me there!



## Publisher's Musings: A completely different world

*JOE FUGATE*



## MRH Website this month: Painting a backdrop, and more ...

*Compiled by JOE FUGATE*



## What's Neat: Designing a layout ops plan, and more ...

*KEN PATTERSON*



## DCC decoder plugs and sockets

*JOE FUGATE*



## Joe Visintine's East Bluff Terminal

*The MRH STAFF*



## Walthers track cleaning car upgrade

*STEPHEN KAY*



## Digital calipers for modeling

*JACK BURGESS*



## Savvy Modeler online: Painting realistic rocks

*Compiled by the MRH STAFF*



## April 2020 news and events

*RICHARD BALE and JEFF SHULTZ*

In

**MRH****RUNNING  
EXTRA**

This month ...

Buy April eBook - \$2.99  
120 pages

store.mrhmag.com

## TABLE OF CONTENTS | RUNNING EXTRA

April 2020

**RUNNING  
EXTRA**

Publisher's Welcome: SMD LED loco headlights ...

JOE FUGATE



Limited Modeler: More Pennsy hopper fun

JIM SIX



Getting Real: Researching prototype structures

MARTY MCGUIRK



Building locomotive paint stands

NORMAN REID



Wine as a traffic generator

PATRICK BRAY

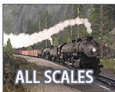

Virtual model railroading, part 2

CHARLIE COMSTOCK



Ah-Hah Moment: Safer model storage

V. S. ROSEMAN

NOW  
IN STOCK

# SD40T-2

## All-Wheel Drive "Tunnel Motor"



Rivet Counter HO Model Shown



**HO**  
1:87 SCALE

Scene and photography by Ken J. Johnson



**Order Now**

© 2020 ScaleTrains.com, Inc. ScaleTrains.com, Rivet Counter, and respective logos are trademarks of ScaleTrains.com, Inc.

ScaleTrains.com, Inc. 7598 Highway 411 Benton, TN 37307  
844-9TRAINS 844-987-2467 International 423-299-3689



[WWW.SCALETRAINS.COM](http://WWW.SCALETRAINS.COM)



# PUBLISHER'S MUSINGS

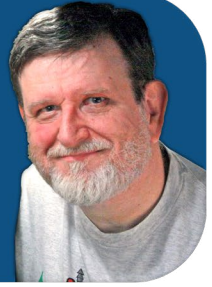

Model Railroad Hobbyist | April 2020

## JOE FUGATE: A COMPLETELY DIFFERENT WORLD



**SINCE LAST MONTH'S ISSUE, THE WORLD HAS** completely changed as a result of the Covid-19 crisis. We all wish it was some kind of bizarre April Fools, but unfortunately it's quite real. We're all in this together, so we might as well make the best of it.

### Making lemonade out of lemons

If you're growing weary of all the bad news in the media while battering down the hatches and being stuck at home, it's time to take these lemons and make lemonade!

Our great hobby of model railroading can provide a healthy and satisfying pastime until the media returns to its regularly-scheduled obnoxiousness (and make no mistake...they will).

Many of us have enough in our hobby stash we could almost start our own hobby shop. With a lot more time on our hands, it's time to pull out some of that stash and get to building some models!

We can also be thankful we have the internet. It's possible here in 2020 to stay well-connected without ever leaving our homes. We can share photos of the things we're working on and help inspire each other into expanding our hobby skills. Plus if you're bored, MRH has over 20,000 free pages in our magazine back issues: [[mrhmag.com/magazine/back-issues](http://mrhmag.com/magazine/back-issues)].

## Making it easier to access our resources

For the next 30 days (at least), we're making all of the MRH resources easier to access.

Registered MRH members have had the ability to always get 10% off on all MRH Store items (books, DVDs, and downloads) and 10% on TrainMasters TV memberships.

Effective immediately, we're *doubling* that discount code to 20% off. Just visit [[mrhmag.com/monthly-coupon-code](http://mrhmag.com/monthly-coupon-code)] to get the MRH Store discount code. You do need to be a registered member to access the code, but registering has always been free.

TrainMasters TV members have always received a 15% discount code for the MRH Store, but we're increasing that discount to 25% off. You

### ADVERTISEMENT

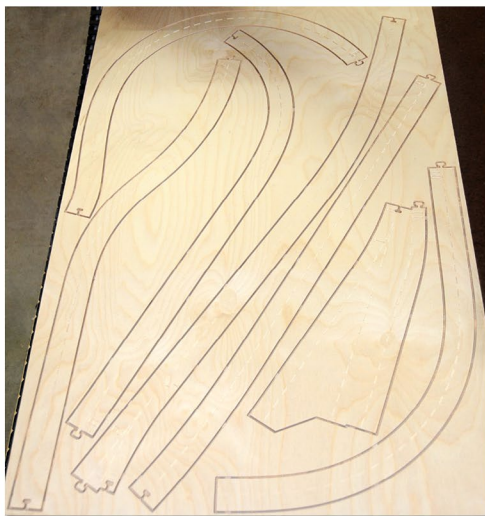

Splines make *smooth* curves.



Making splines takes a *long* time!

Custom CNC roadbed is precise, costs less, and builds more quickly.

Laser-cut splines - accurate enough for hand-laid track.

*Plan for the future!*



*How will you build your layout?*

**3<sup>rd</sup> Plant 3D CAD**  
The ultimate track planning software

El Dorado  
SOFTWARE

**Click here to learn how!**

**N**  
SCALE

*Spectrum*

**DCC**  
SOUND VALUE  
ON BOARD



## NORFOLK & WESTERN CLASS J 4-8-4 RETURNS TO SERVICE NOW EQUIPPED WITH DCC ECONAMI™ SOUND VALUE

The "J" was the last mainline steam engine to run in the United States. Bachmann's classic N scale Class J is making a new run, equipped with an *Econami™ SoundTraxx®* steam package. Factory-set for Class J 4-8-4 realism, the steam package offers a choice of 16 whistles, multiple variations of 6 bell types, 4 prototypical chuffs, 5 airpumps, and 4 dynamos plus cylinder cocks, grade crossing signal, blowdown, brake squeal/release, coupling/uncoupling, water stop, and "All aboard"/coach doors—all in 16-bit polyphonic sound.

Features include:

- DCC sound-equipped with *Econami™* Sound Value package
- precision motor
- die-cast boiler, underframe, and tender frame
- separately applied detail parts and laser-cut exterior detailing
- die-cast finescale driver spokes
- *E-Z Mat®* Mark II coupler, rear



N&W #602  
Item No. 53251

**Econami™**

Click to  
learn more



N&W #608  
Item No. 53252



N&W #611  
Item No. 53253

Shipping Spring 2020  
MSRP \$439.00 each



Bachmann Industries, Inc. • 1400 East Erie Avenue • Philadelphia, PA 19124 USA • [www.bachmanntrains.com](http://www.bachmanntrains.com)

Click for more information.

[MRHMAG.COM](http://MRHMAG.COM)

[INDEX](#)

[TABLE OF CONTENTS](#)

# NEW SOLAR SYSTEM SERIES



## 9-CAR SERIES WITH LIGHT UP PLANETS!

## BEGINS MAY 2020

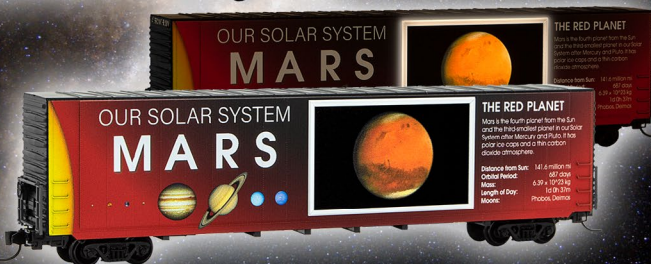

## CLICK HERE FOR MORE INFO

## EDITOR-AT-LARGE | 3

can access that code by logging into your TrainMasters TV account and then visiting this link:

[\[trainmasters.tv/pages/mrh-store-tmtv-mbr-specials\]](https://trainmasters.tv/pages/mrh-store-tmtv-mbr-specials).

And if you've ever thought of becoming a TrainMasters TV member, we're making all memberships **30% off right now**.

Finally, we've decided to do something very special with our new no-ads monthly eBook, *Running Extra*. We've taken seven of the highest rated articles from the 2019 eBooks and we've collected them into our [Best of 2019 Sampler](#) – and have decided to make this 100-page eBook free. That's right, it's *free!*



2019 Sampler - \$2.99  
On special: FREE!  
**MRH RUNNING**  
**EXTRA**  
Apprentice with savvy modelers

New Allagash Shortline  
▶ READ NOW

**The BEST of 2019**  
Seven of the highest rated articles of 2019

ALSO in this SAMPLER edition:

- Getting started with Parfithoids
- Layout design with Sandborn Maps
- IREX cabinets as layout benchwork
- Oakleaf yarding/ra model trees
- Building your first resin boxcar
- Better small scale figure faces
- ... all this inside!

PORTRAIT EDITION **S** SUBSCRIBE **▶** TABLE OF CONTENTS

[MRHMAG.COM](http://MRHMAG.COM)

[INDEX](#)

[TABLE OF CONTENTS](#)

# BUILDING IS UNDER WAY

DON'T MISS OUT, JOIN THE FUN TODAY!

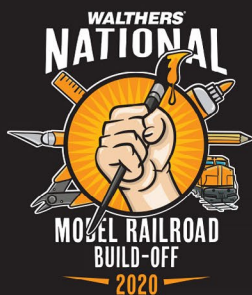

Form a team or go solo.  
Show us *your* creativity at work.

Enter the 2020 Walther's National Model Railroad Build-Off and you could win **BIG cash prizes up to \$2,000!**

Visit [walthers.com/NMRBO](http://walthers.com/NMRBO) for details!

**WALTHERS**<sup>®</sup>

Support your local hobby shop • visit [walthers.com](http://walthers.com) • call 1-800-4-TRAINS

©2020 Wm. K. Walther's, Inc.

[MRHMAG.COM](http://MRHMAG.COM)

[INDEX](#)

[TABLE OF CONTENTS](#)

## We're taking no profits

We've also decided to take no profits during this time. Instead we are dedicating any surplus to funding modeler scholarships.

If you are a modeler who is now out of work or dealing with a difficult hardship during this time, then consider putting your name in the hat with us for a scholarship. Here's the link:

[\[mrhmag.com/hardship-scholarship-entry\]](http://mrhmag.com/hardship-scholarship-entry)

We're offering free months of TrainMaster TV memberships, or if that doesn't work for the scholarship recipient, we're offering them some free product downloads from the MRH Store.

So far, we've funded 36 free months and we're just getting started. If you purchase anything from us during this time, a portion of your purchase will be used to fund these modelers dealing with hardships at this time.

Next month we will be giving you some names of the modelers you have helped, and with their permission, even share some of their stories with you.

## Things hit home

Unfortunately, this pandemic has become all too real for us. One of the MRH Staff members, Richard Bale, lost his oldest son to Covid-19 recently. They're stunned since their son was only 59 years old and in good health prior to this.

One of our local modelers, Greg Martin, is in the ICU on a ventilator with the Coronavirus. Greg has come and operated on my Siskiyou Line several times, so this is very troubling news.

MRH itself is seeing some steep revenue downturns, so I've had to lay off several staff members. That puts more load back on me, which means among other things, the Locomotive book project

# All the Features. Nothing Missing.

**Athearn® DCC+Sound models contain  
a full-featured SoundTraxx® Decoder**

FEATURING  
**SOUNDTRAXX®**  
New Dimensions in Digital Sound Technology

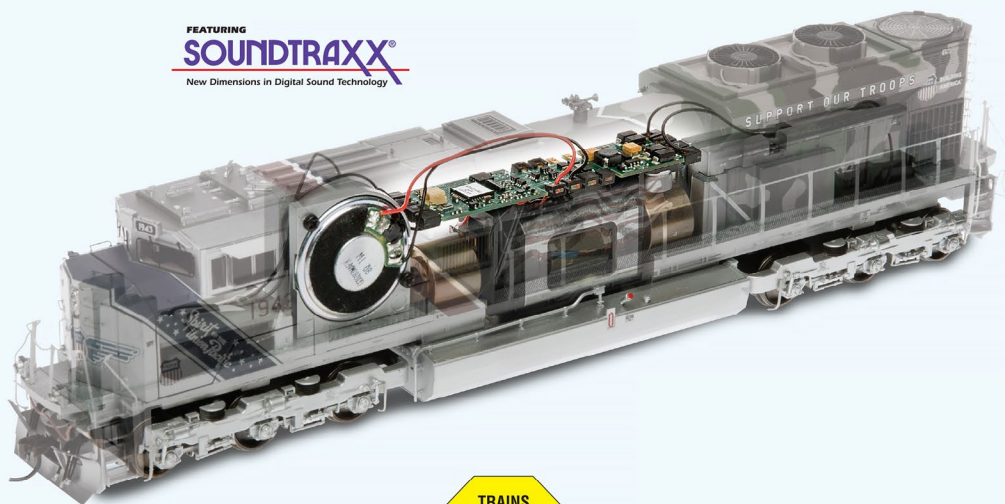

Athearn® DCC+Sound models have appropriately preloaded horn and prime mover sounds as per the prototype model. Additionally, many unique recordings are available only through the Athearn OEM factory-installed SoundTraxx decoder.

Visit [www.Athearn.com](http://www.Athearn.com) for a complete list of models and features. Get your order in today!

©2019 Horizon Hobby, LLC. Athearn, Trains in Miniature, and the Horizon Hobby logo are trademarks or registered trademarks of Horizon Hobby, LLC. SoundTraxx is a registered trademark of Throttle Up! Corp. All other trademarks, service marks and logos are property of their respective owners. Final models may vary slightly from photos shown. 61139

**HORIZON**  
H O B B Y

**30% off**  
**ALL**  
**TrainMasters TV**  
**memberships**  
**THIS MONTH**



**Check it out!**



[www.trainmasters.tv](http://www.trainmasters.tv)

is on hold until this thing passes and we can bring the staff members back on board to give me more time for extra-curricular projects.

Less staff and less ad revenue also means look for some magazine downsizing. We can only produce as many pages as we can pay for.

I'd love it if making good quality, well-vetted modeling info took zero time and just grew on trees. For better or for worse, this info all takes time to produce, edit, package, and distribute.

Just because it's digital doesn't make it take any less time than what it takes to make paper pages or make DVD videos.

Also look for layout tours to dry up for a while. For some reason, nobody wants us to come visit them and shoot their layout.

## Some real heroes

Because MRH is seeing some revenue downturn, I have contacted our contributors and explained to them that article payments are



# MRC Prodigy DCC

## Less Work, More Play

**MRC Prodigy systems** are designed with engineering so advanced it allows us to put instructions on the back of the handheld... so you can start enjoying DCC faster and easier.

Others insist on a 60-80-page manual. We have one too, but it's just 20 pages. And you can get started without it. Nothing could be more user-friendly than Prodigy DCC systems, yet we didn't sacrifice one sophisticated concept. In fact, we added some.

Learn all about Prodigy's features and unique ability to let you work less and play more while enjoying DCC.



CLICK  
HERE



MODEL RECTIFIER CORPORATION

360 Main Street, Suite 2, Matawan, NJ 07747 • Phone: 732-225-2100 • [www.modelrectifier.com](http://www.modelrectifier.com)

FOUNDED BY ROY C. GELBER

■ Train Controls ■ Model Railroad Accessories ■ Plastic Model Kits ■ Scenery ■ Educational Kits

[MRHMAG.COM](http://MRHMAG.COM)

[INDEX](#)

[TABLE OF CONTENTS](#)



# MRH Media and the pandemic

## 1. Our first priority:

Taking no profits during this time ...  
any surplus goes to help those out of work

- Contributors out of work go to the top of the payment list
- For modelers facing hardship -- surplus will fund MRH paid content scholarships at no charge. Put your name in the hat to receive a hardship scholarship:

Submit MRH hardship scholarship entry



## 2. Our second priority:

To help encourage modelers stuck at home, we're giving extra discounts on how-to hobby content:

- 20% off code at MRH Store to all registered MRH readers

**Get 20% off code**

*Must be MRH registered reader*

Become registered MRH reader (free): [Register now](#)

- 25% off code at MRH Store to all TrainMasters TV members

**Get 25% off code**

*Must be TMTV member*

- 30% off all TrainMasters TV memberships

**Save 30% off**

- FREE best of 2019 Running Extra sampler (100 pages)

**Get free eBook**

likely to be delayed more than normal until this thing is all over. Our goal is to pay for articles within 30-60 days after publication. Depending on how good ad revenue is, that can vary, especially in the summer and fall when the hobby seasonally bottoms out.

Here is what I've told our contributors:

1. If you are out of work and things are uncertain financially, let us know and we will move you to the top of the list for payment.
2. If you are doing okay financially and can afford taking a reduced payment at this time, that will really help.
3. If you have been looking at a product we offer in the store or thinking about trying TrainMasters TV and you're doing okay financially, going ahead with a purchase would be helpful right now.

## Some MRH Heroes

The following contributors are making financial sacrifices to help MRH. We are very humbled by their amazing generosity, and want to recognize them for their contribution.

<b>Tony Thompson</b>	<b>David Bott</b>	<b>Terry Chamberlin</b>
<b>Brian Krupica</b>	<b>Jack Burgess</b>	<b>Bob Morningstar</b>
<b>David Forbes</b>	<b>Ben Kaur</b>	<b>Richard Deuso</b>
<b>Charlie Comstock</b>	<b>Jack Heninger</b>	<b>Jeremy Dummler</b>
<b>Carl Blum</b>	<b>Evan Neubee</b>	<b>Nick Muff</b>

Thanks so much (I hope I haven't forgotten anyone).

We *will* get through this, please stay safe. You're some of the greatest people on the planet!

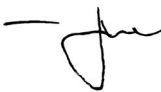

# Can you better leverage your hobby resources?

Every copy of MRH's *Running Extra* has tips that can save you hundreds of dollars and hundreds of hours ...

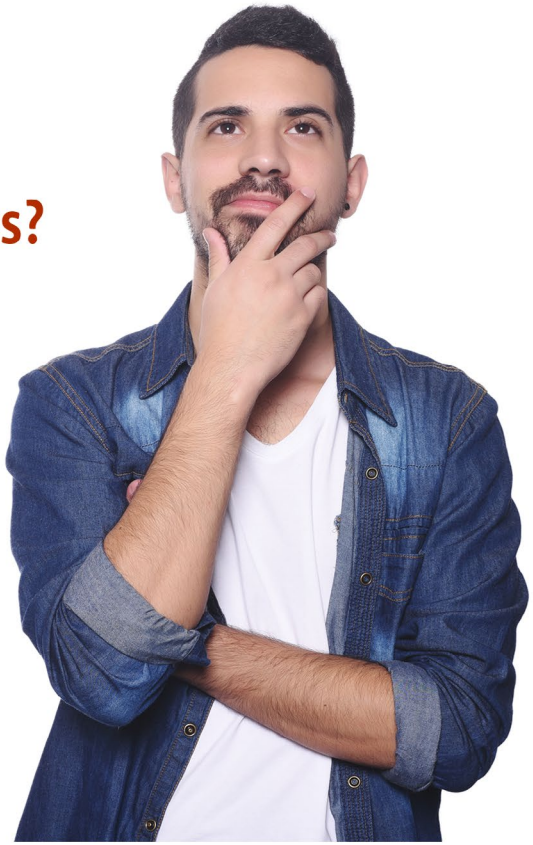

~300 pages, \$2.99 ea.  
1 year sub: \$19.99

~150 pages of all-meat in-depth articles and columns + all the free MRH content with ads ... one download gets it all!

You can buy and download single issues or get a 12-issue subscription.

**Shop MRH  
Running Extra**

[click here](#)

April 2020 - \$2.99

**MRH RUNNING EXTRA**  
Apprentice with savvy modelers

Patrick Bray explores  
**Wine as a traffic generator**  
▶ **READ NOW**

LANDSCAPE EDITION

[SUBSCRIBE](#)
[INDEX](#)
[TABLE OF CONTENTS](#)

All 60 (to date) months' content:  
- Researching prototype structures  
- Build a loco paint stand  
- Loco headlights from SMD LEDs  
- More early Pennsy hopper fun  
... and much more hidden!

~300 pgs ... if was a paperback, would be almost 1" thick -- for just \$2.99!

Paper mags: 8 cents per page  
**Running Extra: 1 cent per page!**



## LAST ISSUE'S RATINGS

The three top-rated articles in the [March 2020 issue](#) of *Model Railroad Hobbyist* are:

4.4 John Peluso's Frisco Eastern Division

4.4 March 2020 news

4.1 Quad servo DCC decoder: 2

Issue overall: **4.2**

**Please rate the articles!** Click the reader comments button on each article and select the star rating you think each article deserves. We depend on these ratings to help us determine which articles to publish, so your rating matters! ■

Get the latest Model Railroading News, Tips, Reviews & Opinions

**CHECK  
IT OUT!**



**Our iTunes feed has changed search for  
"Crew Call with Mike Rose" to receive the latest episodes!**

**[www.themodelrailroadpodcast.com](http://www.themodelrailroadpodcast.com)**

Host:

Mike Rose: [www.mrhobby.com](http://www.mrhobby.com)

**Don't Miss our Monthly Interviews  
& Product Announcements**

# THE HO M420 IS... **AMMMAZING**



# CLICK HERE

Best of the

# MRH WEBSITE



THIS MONTH

Model Railroad Hobbyist | April 2020

compiled by **JOE FUGATE**



**RATE THIS ARTICLE**

## Backdrop painting time-lapse

MRH forum member **johncaff22** (*John Caffarelli*) shares this fascinating backdrop painting time-lapse video on his MRH blog:

“With unexpected time for working on the railroad I was able to complete the base painting of the backdrops on the upper level.”

View the video on the MRH website by clicking below.



[View the full thread on the MRH website](#)

▶ **MRH'S MONTHLY GREAT MODELER POSTS**



1. Mark Paul wants to model a concrete and steel freeway bridge on his layout, so he's documenting the build on the MRH forum.

## Building a concrete and steel highway bridge

MRH forum member **Nsmapaul** (*Mark Paul*) decided to grab the bull by the horns and model a curved and banked freeway overpass on his layout. He says:

“So, last week I had gotten the itch to build a unique highway overpass ... a modern steel girder and concrete bridge type ... and did I mention, it will be on a slight gradient and a mild curve? Well, as most of you know, I love to torture myself. I'll try and document my process [for] those of you [who] wish to undertake a similar modeling experience.”

Follow the progress on the MRH website thread link below.

[Read the full thread on the MRH website](#)



# ANIMATE YOUR BUILDINGS



[ModelTrainMan.com](http://ModelTrainMan.com)

## **NEW** Truck Measuring Caliper Model RT-8-1 HO Truck Axle Caliper



*Adjust to approximate width.*

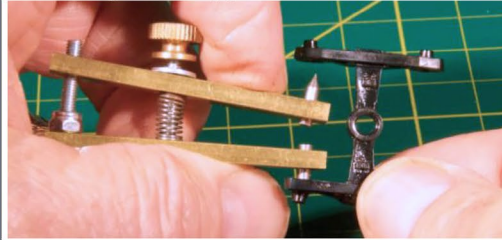

*Squeeze to put in truck frame.*

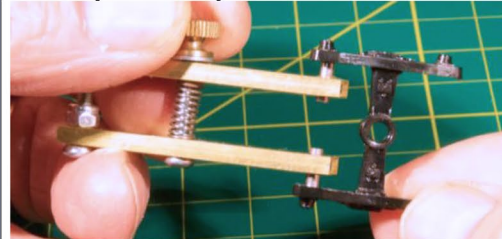

*Adjust Caliper to proper fit.*

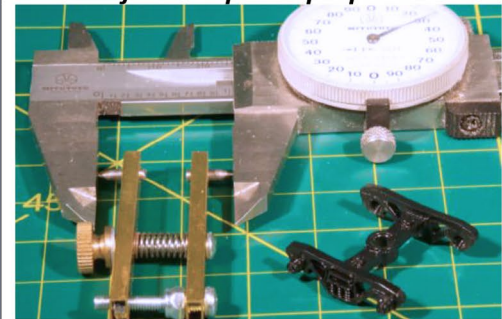

*Measure for proper axle length.*

*Proper axle length is critical for reliable operation. Sloppy short axles allow wheels to lift off rail and derail cars.*

*Limited production.*

**Coffman Graphic Solutions**  
[www.coffmaneng.com](http://www.coffmaneng.com)

## Planning an extension

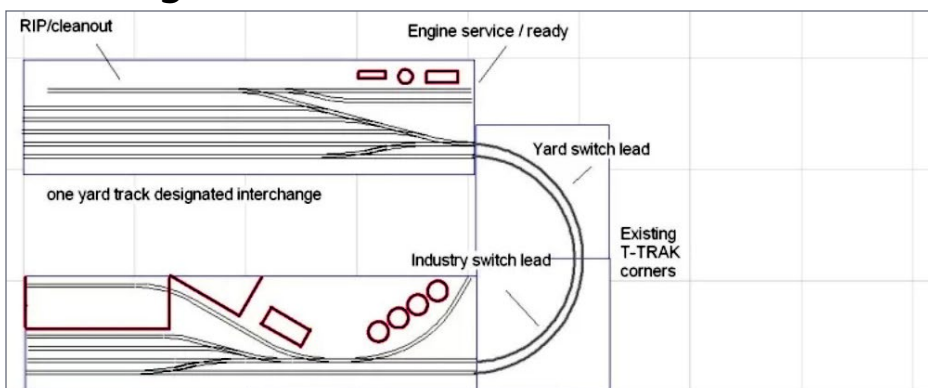

Used at home, no corners

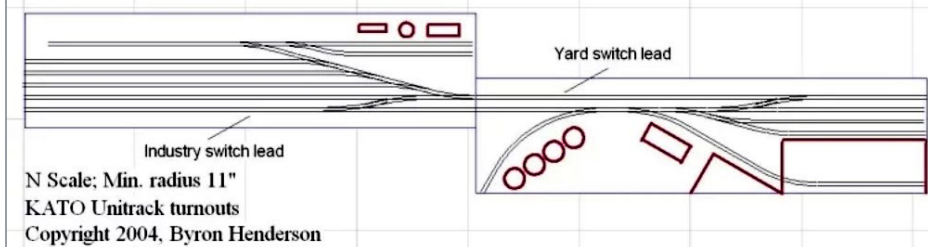

3. Some layout expansion planning ideas offered on the MRH forum by MRH member Cuyama (Byron Henderson).

Forum member **Bremner** (*John Bremner*) posted recently:

“[When] operating [my] Playa Desnuda branch ... there is no way to have the train roll in, switch the industries, then leave town. I am looking at adding the fictitious Washington Blvd. Yard.”

Follow the developments of this layout expansion and the advice other forum members are offering, use the button below.

[Read the full thread on the MRH website](#)

AVAILABLE IN HO & N SCALE

**Just fold, glue  
plug'n'play!**



**FREE SHIPPING  
CHECK 'EM OUT**



**Roomettes**

Bring Your Structures to Light

**Lasercut structures. Highway, storefront and billboard signs.**

Neat ag customer for your railroad:  
**Farmers Fertilizer Supply**



**WHAT'S NEW?**  
↖

Established 1993...

**Blair Line**



**Take the MRH  
2020 Reader  
Survey ...**

amazon

**... and get a chance  
to win a 7" Kindle  
Fire tablet!**  
(5 tablets will be awarded)



**TAKE THE SURVEY >>**



**Archer**  
FINE TRANSFERS  
PROUDLY SERVING MODEL BUILDERS SINCE 1989

THE ORIGINAL  
**SURFACE DETAILS™**

**WE NOW HAVE MORE  
THAN 130 SHEETS OF  
RIVETS, LOUVERS,  
TREADPLATE, WELD  
SEAMS AND MORE  
CAST ONTO  
MICROSCALE CLEAR  
DECAL FILM**

**LOW SHIPPING:**

**DOMESTIC USA ORDERS  
\$2.80  
INTERNATIONAL ORDERS  
\$9.95**

*"Archer Fine Transfers 3D decals have revolutionized kitbashing and scratchbuilding. Putting rivets or other low-relief details like louvers or weld seams on your models is now as easy as applying decals."*

Joe Fugate,  
Publisher/Editor  
Model Railroad  
Hobbyist



➡ **CLICK HERE TO VISIT OUR WEBSITE!** ⚡

Archer Fine Transfers • PO Box 1277 • Youngsville, NC 27596 • USA  
(919) 570-1026 • info@archertransfers.com • archertransfers.com

## Chessie System MOW cars



4. Mike Kingsbury built a wheel car and then added a lifting mechanism with chains to his crane car for getting the wheels on/off the car.

MRH forum member **grenadier1943** (*Mike Kingsbury*) has a running blog about maintenance-of-way cars he's building for his Chessie layout.

“[Here is a] Chessie System C&O MOW wreck train wheel car.

“My inspiration for the project came from the ‘Chessie System Color Guide to Freight Equipment.’ I decided to use only parts that I had available in the modeling room.”

We're really enjoying the many projects Mike posts about and how the forum members pitch in to provide advice and build assistance. Visit the MRH website and read the full thread!

[Read the full thread on the MRH website](#)

## Monthly “What’s on your workbench” thread

Each month, MRH readers post their workbench projects on this monthly workbench thread. Very inspiring and often quite fascinating!

For more great projects, visit the MRH website and view the full thread.

[Read March’s thread on the MRH website](#)



5. MRH forum member **splitrock323** (*Thomas Gasior*) posted this photo of his prototype project (among others). Note the prototype reference photo above and compare that to the model below.





# NEW, LIMITED-RUN MICRO-TRAINS CARS

## SEATTLE NORTH COAST (SNCT) GREEN BOX CAR 4-PACK

**COMING  
OCT 2020**



**CLICK HERE FOR  
SNC BOXCAR**



Green and Yellow  
double doors

Moderate airbrush weathering  
on sides, roof and ends

Rail service in  
Washington State

**COMING  
OCT 2020**

## PROCOR (PROX) GREEN TANK CAR 4-PACK



TRAIN  
ADDITION  
HELP LINE  
866-840-7777

**CLICK HERE FOR  
PROX TANK CAR**



Heavy weathering on  
the top 1/3 of the cars

Subdued Gray  
reflective markings

Accurate painting, printing  
and correct road numbers

# *Pacific Western Rail Systems*

**LIMITED RUN OF MINIMUM 50 SETS-MADE  
EXCLUSIVELY FOR PWRS BY MICRO-TRAINS**



# WHAT'S NEAT

column



Model Railroad Hobbyist | April 2020

**KEN PATTERSON** SHOWS OFF A FRISCO MAIN LINE LAYOUT, DESCRIBES HIS CATALOG COVER SHOT OF BACHMANN'S ALL-NEW AMTRAK CHARGER, AND HEARS HOW TONY PELLEGRINO DESIGNS OPERATIONAL PLANS ...

**IN THIS MONTH'S VIDEO, JOHN PELUSO'S** DISPLAYS his fantastic HO scale Frisco layout representing mainline locations from St. Louis to Springfield, Missouri.



## WHAT'S NEAT!

### MODEL RAILROADING

# Bachmann

## Diorama build



April 2020 show

▶ PHOTOS AND VIDEO OF SUPERB MODELING

### Model photograph design ideas for your models

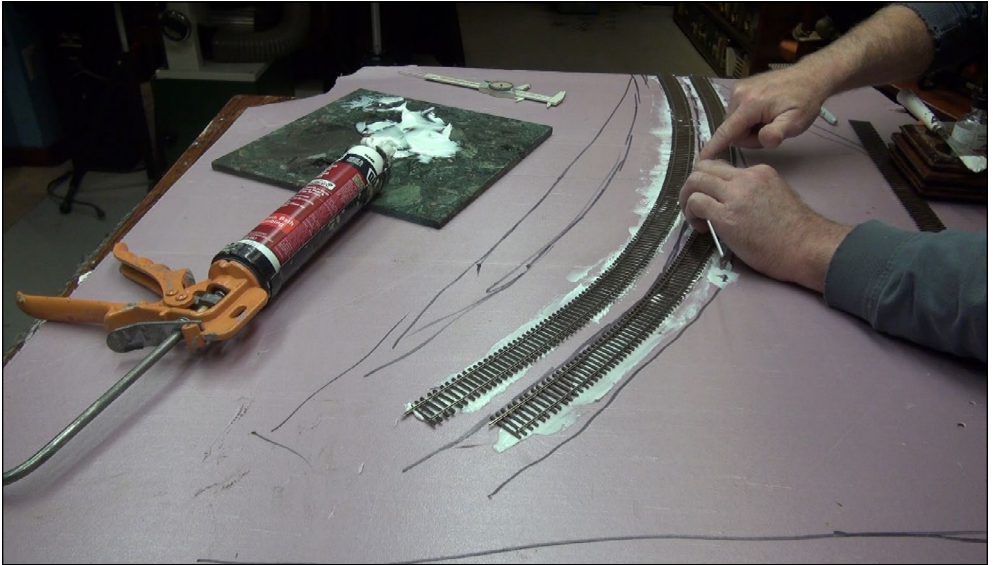

1. This year Bachmann Trains from Philadelphia, Pennsylvania asked me to design a colorful and exciting cover shot for their upcoming catalog. The subject was to be their new Charger locomotive in HO scale. I wanted to create something where the train rounding a super-elevated curve would add movement and speed to the shot, with the locomotive coming right at you through the cover. I set up the camera in front of a piece of pink 2" thick insulating foam. I drew the dimensions of the shot on to the foam, knowing exactly what would be seen through the lens. The curve was super-elevated using two strips of 0.040" Evergreen styrene glued together, making the outside rail of the curve 0.080" higher than the inside rails on both main lines represented in the scene.



**RATE THIS ARTICLE**





2. I used Dap Kwik Seal Plus bathroom adhesive to glue both the Micro Engineering code 83 track and the styrene on to the foam. This glue dries clear and is paintable so ballast will stick to it. Once this was cured, I spray painted the scene with Rustoleum Earth Brown, coloring the rails and track on a newly carved and cut scene that measured the length of the locomotive and two passenger cars.



Also see the "What's neat this week" weekly video podcast!





3. I ballasted the track with fine black cinders from Woodland Scenics. I added backyard dirt for the scenery immediately adjacent to the track and light green and dark green ground foam.



4. I spread the ballast smooth with my finger and followed this up with an artist's fan brush for the length of both super-elevated tracks.



5. Once the track and its surroundings looked prototypically correct, I wet the entire scene with Woodland Scenics Scenic Cement to hold everything permanently in place.



**Use our custom  
Google search on the  
MRH website to find  
topics of interest**

[CLICK TO FIND OUT MORE](#)



6. To use the new track diorama in a photo shoot, I stacked or layered many scenes together using a small four-foot-long hill covered with green fake fur right behind the

foreground track scene. Pine trees stuck to a taller piece of shaped foam made up the third layer of scenery. Each tree was placed into position while looking through the camera outdoors. I then used two 8' long panels of carved foam to represent distant background mountains.



7. Here you see the final photograph. Two passenger cars rounding the curve with a powerful locomotive and plenty of layered scenery to make it interesting.

## Operation design in model railroading



8. Tony Pellegrino has designed operation scenarios on many layouts. Operational design starts with emulating the prototype because trains don't run in circles as they run to make a profit. Trains make money by delivering and receiving goods. Once you think that way about your layout it simply lays itself out. Tony says it all started with him and his wooden trains as a child when he would draw operation on paper and mimic that with his wooden push trains. "I have always loved that part of the hobby, the problem-solving and the prototypical operation of the trains," he says. "If the railroad had tracks in an area, they were there for a reason and it was my job to figure out the 'why' part of the equation as it related to profitability."



**RATE THIS ARTICLE**



9. Brett Tate handles his train's paperwork as Greg Lane, in the background, takes care of their radio chores while operating on Joe and Tony Pellegrino's two-level operating layout. Even if you have a simple circle layout, once you add a siding with a track to place a box car or a tank car, you now have a reason for the railroad to exist rather than simply running in circles.

One thing that helped Tony to accomplish this was to imagine he was the engineer, rather than being separated from the train. This makes him in the crew of the train. For example pull up to the sand siding at Owens-Illinois with three hoppers full of sand. Set out the three loaded cars on to the track. Pull the three empties and take them to wherever they are filled again with sand. That's how simple it is to get started.

You can evolve ops to be as complicated as you want as you learn. You can track car numbers, create train orders or track warrants, use paperwork that tells where each car should go (car cards or switchlist), or add a dispatcher to control train movements.

## WHAT'S NEAT | 9

Tony says he takes his inspiration from real train orders for various prototype locations. He studies where real cars come from and where they go and tries to emulate those patterns on the layout using similar patterns that fit their model railroad.

A lot of the operating research comes from historical societies. This information can be obtained for free from many historical societies online. It can be as much fun to scratchbuild a prototype structure where part of the fun is doing research and planning before you start. Ops research can work the same way!

### John Peluso's Frisco Layout in HO Scale



10. In this month's video we get to see this wonderful layout where the trains really move. John Peluso has been a model railroader for 50+ years. His passion for the hobby comes from all aspects of model railroading that include scenery, carpentry, electrical, painting, and railroad operations.



11. During an operating session, John's railroad keeps seven operators busy with a three-hour session split into two segments of 90 minutes each. A dispatcher and two to four yard crews keep things moving fluidly. They use a dispatcher's board with a track plan painted on a metal surface. Small painted magnets represent all the trains on the main line and yards to prevent cornfield meets on the main. They use two-way radios to keep the road crews, yard crews, and dispatcher in contact on the double-deck layout.

## Remember to click on the ads!



**RATE THIS ARTICLE**





12. When was a kid, he and his friends would ride their bikes down to the MoPac and Frisco mainlines and watch trains all day long. It's that part of this childhood that he models on the layout.

The areas around St. Louis are modeled to represent the prototype locations accurately, for example Webster Groves train station, Valley Park, and the Meramec River crossing bridges. "I want people to know where they are at, they've been there, they can recognize that. It's a personal fulfillment I like personally."

The layout occupies 16x30'. The lower level is 43 inches and the upper level is 62". There is 400' of code 83 track on the two levels, connected by a helix that takes 2 minutes and 20 seconds to climb from one level to another. The layout has a minimum radius of 30".

Many of the trees are Scenic Express "Super Trees" with that fantastic fine branch structure, the ballast is from Woodland Scenics ballast and there are many scratchbuilt buildings and bridges.



Also see the "What's neat this week" weekly video podcast!

**WATCH  
NOW >>**



13. One of the amazing parts of the layout is the folding gate in a corner of the layout that allows access in and out of the layout room. It has two tracks on the upper level and three tracks on the lower level with full electrical power to the rails and curved backdrops. The video runs 10 minutes with the full interview and is amazing to watch in action.



DID YOU KNOW  
MRH REGISTERED READERS GET FREE BONUSES?



14. Both levels swing at the same time to open the accessway to John Peluso's well-crafted Frisco.

*Did you see this article*  
In **MRH** **RUNNING** ?  
**EXTRA**



**Modeling early  
20th century  
PRR hoppers**

**Get the April eBook now**  
*click here*



Also see the "What's neat this week" weekly video podcast!





## **Zephyr Express, the Fast Track to Digitrax Complete Train Control**

- **3.0 Amp LocoNet Command Station, Booster, & Throttle**
- **Color 2.4" LCD Screen**
- **Large Backlit Keypad**
- **Runs up to 20 Loco addresses and throttles**
- **Integrated USB Computer Interface**
- **Control lights and sound with 29 functions**
- **Simple Set-Up with Easy to read display**

Find out more @ [www.digitrax.com/dcs52](http://www.digitrax.com/dcs52)

# Introducing

# ZEPHYR *express*™



**\$235.00 MSRP**

Don't settle for all your locos  
sounding the same!

ESU now has **OVER 100**  
"LokSound" files to choose from!

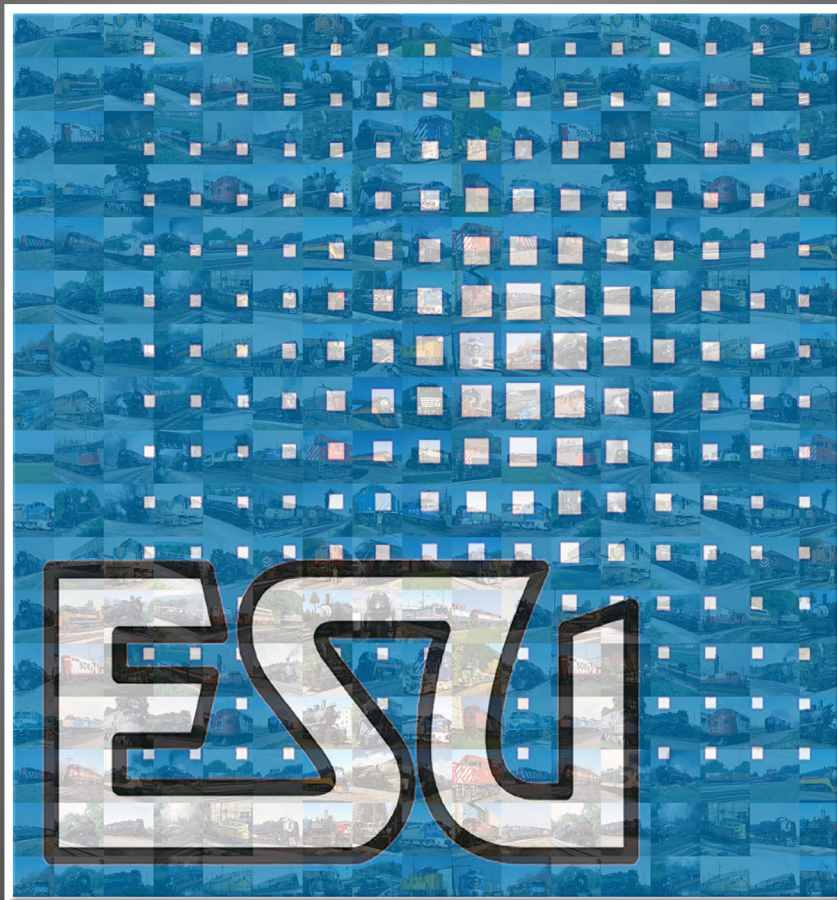

Because "Close Enough" is no longer  
"Good Enough"

[LokSound.com](http://LokSound.com)

# DCC plugs and sockets

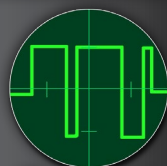
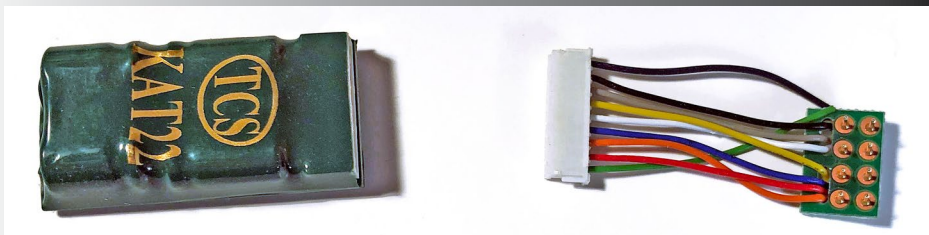

Electrical  
Impulses

Model Railroad Hobbyist | April 2020

1. This Train Control Systems combination T1 decoder with KA2 Keep Alive® includes one of the most common DCC plug-n-play plug combinations – the NMRA 9-pin JST decoder socket and the 8-pin NMRA medium/NEM 652 plug.

**JOE FUGATE** reviews the different DCC decoder plug standards and how to work with them ...

**AFTER BEING INTRODUCED IN THE EARLY '90S**, various DCC decoder plug-in standards have emerged as we moved away from hard-wired to plug-and-play. Which plug works for what situation can be confusing, so let's sort it all out for you.

But before we do that, a word about the plug standards, which do vary slightly between North America and Europe.



**RATE THIS ARTICLE**

## The NMRA and the NEM

MRH Media focuses on North American modeling, so the modeling standards we pay most attention to come from the NMRA (National Model Railroad Association). Our friends across the pond in Europe have their own standards established as the NEM (Loosely translated as “Normal European Modelling” standards).

While the two standards have significant overlap, differences do exist as well. Since some decoder makers such as ESU Loksound have their headquarters in Germany, they lean toward favoring the NEM standard a bit more. That said, ESU has taken great pains in recent years to be a lot more cognizant of the NMRA DCC standards, so we applaud those efforts.

We explain the differences between the two standards as we go along.

## Overview of the different plug types

Before diving into the details of each plug type, let's first conduct an overview. Table 1 lists the most common plugs in use. For a visual catalog of these plugs, see [2] and [3].

## NMRA large, medium, small – and JST decoder plug

The NMRA has four core decoder plug standards, the large, medium, small, and JST decoder plug standards. Information is scant on the large 4-pin standard and we can't find any implementation examples of it. Recently, the NEM 654 standard was deleted by the European MROP guidance organization. So the NMRA large



# Great control in a tiny package



**Original  
Touch Toggles**

- Touch Toggle™ plug in controls
- Bright clear indication
- Easy setup
- Flexible system

Stall Motors, Twin-coils,  
Power, and Servos

Now for Tam Valley Depot  
and MRservo too!

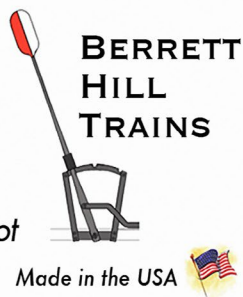

What will they think of next?

[www.berrethillshop.com](http://www.berrethillshop.com)

ADVERTISEMENT

[www.SBS4DCC.com](http://www.SBS4DCC.com)



**DCC Specialties** INNOVATION FOR DCC **MRC** Model Rectifier Corporation

**ACCUTRACK II SPEEDOMETER** **SPROG DCC** the DCC Programmer and Control Family **Digital plus** by Lenz

**TAM VALLEY DEPOT** Great Electronics for Great Model Railroads **TEAM DIGITAL, LLC** Improving the world of DCC

**N - HO - HO<sub>N3</sub> Scale Trains**

ADVERTISEMENT

[TamValleyDepot.com](http://TamValleyDepot.com)



**Home of the  
Frog Juicer**

Our best-selling  
Micro Switch Machine

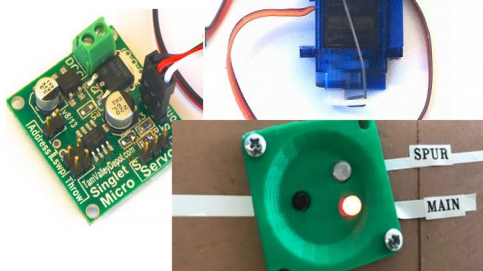

3D Printed Switch Machines and  
Fascia Controllers now available

## THE EVOLUTION OF PLUG-N-PLAY

When DCC first entered the hobby in the early 1990s, plug-n-play did not exist. All decoder installs had to be hard-wire installs.

The first major plug-n-play option came with the NMRA medium / NEM 652 8-pin plug, which has become widely adopted in HO and larger scale locomotives. A few N scale locos use this 8-pin socket as well, mounting it sideways on the loco motherboard. While that's better than nothing in N, it's awkward.

The 6-pin NMRA small / NEM 651 plug fits better in N scale locomotives, but has mostly seen adoption in European N scale models – very few North American N scale loco makers have adopted this design. One North American manufacturer, Fox Valley, has adopted the 6-pin standard for their N scale locomotives.

To date, most N scale locomotives require DCC decoders using a loco motherboard replacement form factor or they come from the factory with custom DCC decoder motherboards.

With the introduction of sound decoders and many extra lighting functions, eight pins just were not enough, so a new 21-pin standard came on the scene. But this new 21-pin standard doesn't fit in N or Z scale locomotives at all.

More recently, the Next18 standard has started to become popular. This plug standard is physically much smaller and easily will fit into N and Z locomotives, yet has plenty of pins for the more advanced decoders.

On top of all these pin standards, a new PluX standard has appeared, which allows using one socket to accommodate 8, 16, or 22 pins. These varying plug sizes allow adapting the plug for more limited space situations in the smaller scales or for more basic decoders which do not need all the extra pins. ■



*Did you see this article*

In **MRH** **RUNNING** **EXTRA** ?



**Make your own  
SMD LED loco  
headlights**

**Get the April eBook now**

← *click  
here*

4-pin standard now looks outdated, so we won't discuss it any further here.

The other three standards, the medium, small, and JST decoder plug standard do have implementation examples, so let's look at them.

DCC Interface Plug Conventions		
Name	NMRA	NEM
4 Pin	NMRA Large	NEM 654
6 Pin	NMRA Small	NEM 651
8 Pin	NMRA Medium	NEM 652
9 Pin	NMRA JST decoder	-
21MTC	21MTC	NEM 660
Next18	-	NEM 662
PluX	PluX8/16/22	NEM 658

Table 1: List of the DCC interface plugs in common use.

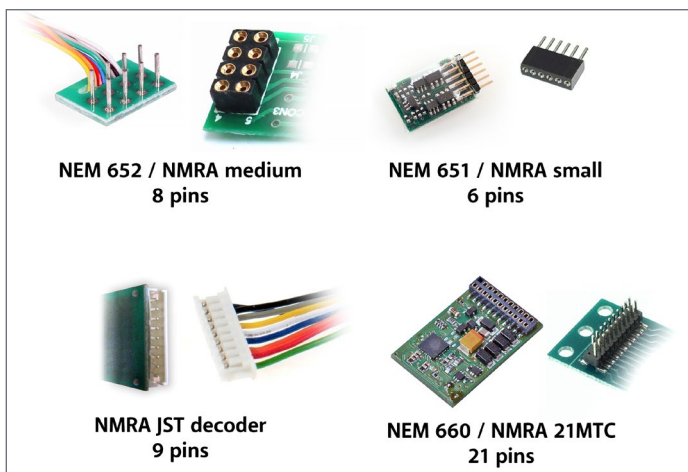

2. The four most commonly used DCC interface plugs.

**WE MAKE  
DCC FUN!**



**S T A T I O N**

Your one stop shop for:  
Digitrax, NCE, Speakers,  
SoundTraxx, ESU LokSound,  
Train Control Systems (TCS),  
Tam Valley Depot (TVD),  
& More!

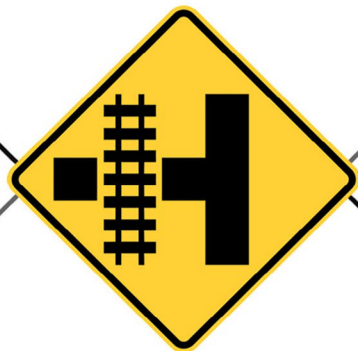

**[www.LitchfieldStation.com](http://www.LitchfieldStation.com)**  
**[sales@litchfieldstation.com](mailto:sales@litchfieldstation.com)**  
**623-298-7355**

## NMRA large, medium, small – and JST decoder plug

As [4] shows, these plug standards cover all the main rail and motor wire routing, along with the front and rear headlights. The NMRA 9-pin JST decoder plug standard includes wires for F1 and F2 as well. Those two extra function feeds (green and purple) come as loose wires out of the decoder and need to be hard wired to whatever they control in the locomotive (most often additional lighting).

However, most modern decoders allow remapping functions to various outputs, so if you prefer the green and purple wires to be used for a different function key, you can likely remap it. Remapping functions is outside the scope of this article – we will cover that in a future article.

Note that if you plug the 8-pin plug in backwards, the motor will run backwards and your light functions will not work. If you notice this behavior in your decoder install, just turn the plug around.

All decoder manufacturers provide decoders with the 8-pin standard plug as a common wiring harness option. Many locomotives

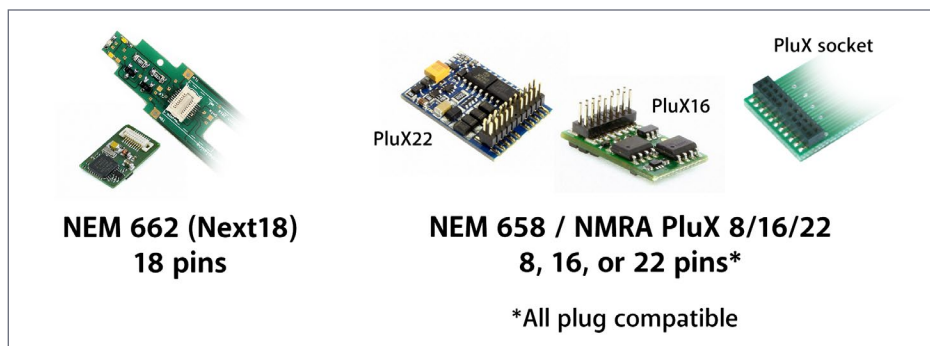

3. Two of the newer additions to the DCC interface plug options.

**RailPro**<sup>TM</sup>**NEW  
TECHNOLOGY****RE RING**<sup>TM</sup>  
ENGINEERING**DCC + RADIO CONTROL**  
HO Scale Locomotive Module**ULTIMATE  
SERIES  
SOUNDS****TRUE  
MOTION  
TECHNOLOGY****LIGHT  
EFFECT  
EDITOR**

New Sound Technology and Mathematical Model Motion Control + more!!!



+

Equals  
"DUAL MODE"  
Control by DCC +  
Radio Control**Click Here to  
Watch Video**For more information visit our Internet site: [www.RingEngineering.com](http://www.RingEngineering.com)

ADVERTISEMENT

**TrainSpotter**<sup>TM</sup>  
ROCK SOLID TRAIN DETECTIONInfrared train detection  
that simply works!

- Detect trains in staging
- Activate grade crossings
- Play sound effects
- And more!

PURCHASE ONLINE AT:  
[IASCALED.COM](http://IASCALED.COM)**Take the MRH  
2020 Reader  
Survey ...**

amazon

... and get a chance  
to win a 7" Kindle  
Fire tablet!  
(5 tablets will be awarded)**TAKE THE SURVEY >>**

come with the 8-pin socket as standard, although that's starting to change to other standards with more pins as sound decoders gain in popularity.

Many non-sound decoders also use the 9-pin JST standard plug on the decoder. This enables swapping out the decoder harness as needed to get the most convenient wire length for your locomotive [5].

The NMRA small / NEM 651 standard seems to be mostly used in Europe for N scale locomotives. The only North American firm we could find that uses this standard in an N scale locomotive is Fox Valley Models.

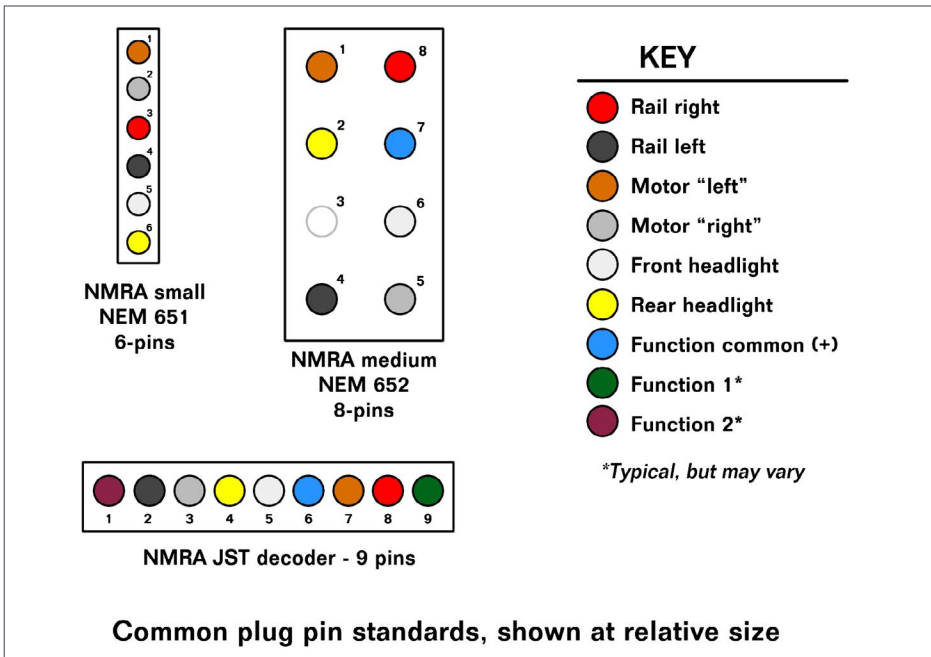

4. Here are the three common NMRA plug standards and their pin-outs identified.



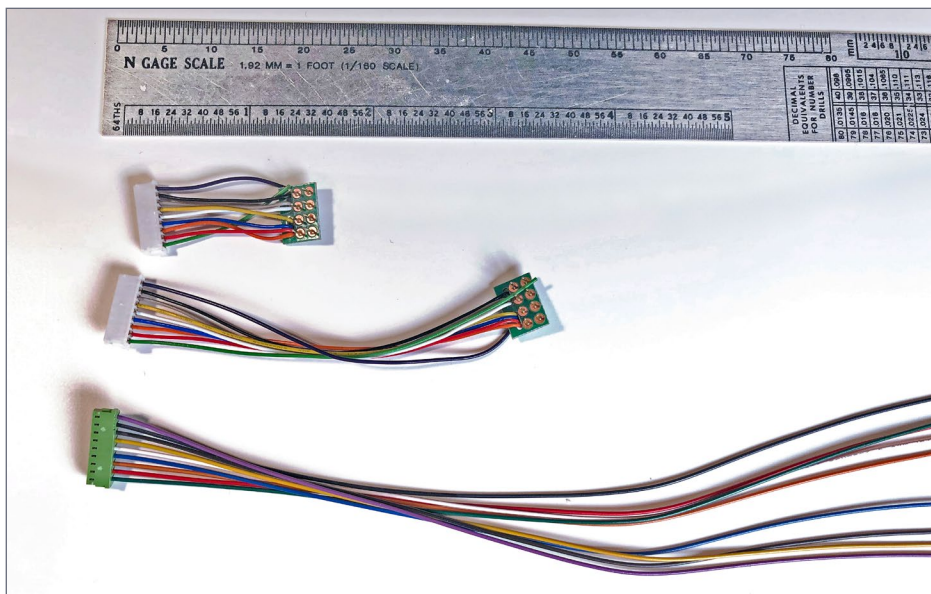

5. The NMRA 9-pin JST decoder plug allows swapping out wiring harnesses to get the length needed for your particular loco install. Shown from top to bottom are harnesses of 1.5", 3.5" and 9" in length.

**Did you see this article**

In **MRH** **RUNNING** **EXTRA** ?



**How to research & model prototype structures**

**Get the April eBook now**

← *click here*

## The 21-pin “standard”

As more advanced lighting and sound features have appeared in decoders, the ubiquitous 8-pins just aren't enough to cover it all. Enter the 21-pin “standard.”

I put “standard” in quotes because it's close but not quite 100 percent, with the NMRA and the NEM standards having a few minor (but potentially annoying) differences.

Even though the connector has 22 pins, pin 11 is “blanked” to act as an index and make it impossible to install the plug backwards. That leaves 21 pins for active use. For a description of what the more esoteric pin outs such as **TB clock** or **Vcc** mean, you can read the full official standard here:

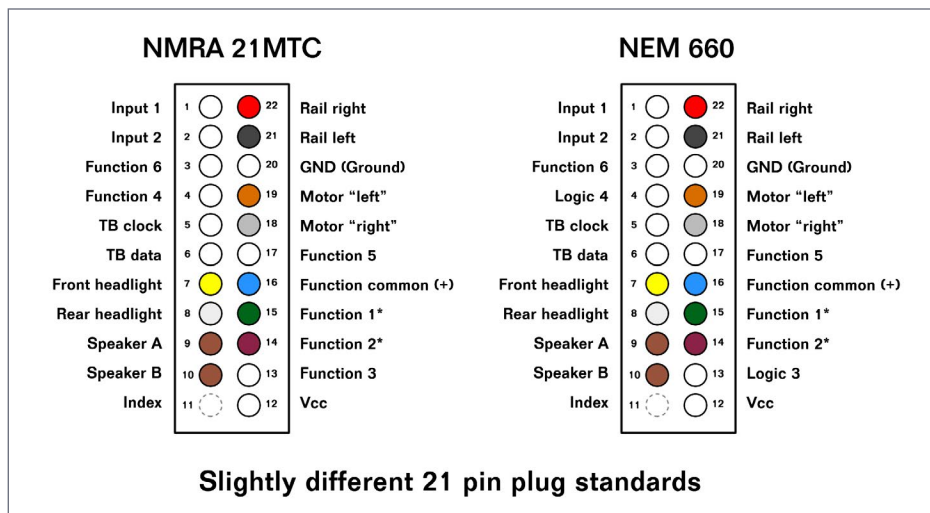

6. Comparing the NMRA 21MTC standard to the NEM 660 standard. They're close, but not exactly the same.

NMRA S-9.1.1 standard (scroll down to section E):

[nmra.org/sites/default/files/standards/sandrp/pdf/s-9.1.1\\_connectors\\_2015.05.22.pdf](http://nmra.org/sites/default/files/standards/sandrp/pdf/s-9.1.1_connectors_2015.05.22.pdf)

NEM 660 standard (in German):

[morop.org/downloads/nem/de/nem660\\_d.pdf](http://morop.org/downloads/nem/de/nem660_d.pdf)

The big difference between the NMRA 21MTC standard and the NEM 660 standard [6] comes down to functions 3-6. The NEM standard specifies those functions as “logic” instead of “functions” – which means the output is just a ~5V digital signal when it’s a logic pin out. For a function pin out, you get a full constant 12-14 VDC output that can drive other electronics like LEDs properly.

ESU makes an adapter board (59168) so that the logic signals on an NEM standard decoder may drive LEDs or other such electronics. But there are no adapter boards to go the other way and take a function output and make it act like a logic output.

See [Table 2] for a list of which manufacturers support which standard. For more on the whole 21-pin standard and the differences, see Mark Gurries’ webpage on the topic: [[mrhmag.com/magazine/url/gurries-21pin-issues](http://mrhmag.com/magazine/url/gurries-21pin-issues)]

Note that Digitrax actually includes the ability to set a decoder CV and swap the F3-F6 outputs between digital logic outs and full power function outs.

NixTrainz offers a 21-pin adapter board called the Decoder Buddy that greatly simplifies the installation of 21 pin decoders into a locomotive when adding stay alive or special lighting using F1-F6. We covered the Decoder Buddy in the April 2019 issue of MRH: [[mrhmag.com/magazine/mrh2019-04/electrical-impulses](http://mrhmag.com/magazine/mrh2019-04/electrical-impulses)].

Strictly speaking, the 21-pin standard has been declared obsolete by the NMRA, to be superseded by the PluX standard (more on that

below), but manufacturers persist in making decoders that use the 21MTC standard. We hope at some point, the manufacturers will finally move to the PluX standard.

## The Next18 plug

The 21-pin standard is great for HO and larger, but the socket is too large for N and Z scale locomotives.

Enter the Next18 plug standard – with a much smaller form factor that fits into N and Z scale locos. And it has many more pins, which provides more advanced decoder plug-n-play connections than do 6 or 8 pins.

The NMRA has not embraced the Next18 standard, but the NEM has adopted it as the NEM 662 standard.

Manufacturer	Standard	Notes
ESU	NEM	
TCS Steam	NMRA	
TCS Diesel	NEM	
ZIMO C ver	NEM	
ZIMO D ver	NMRA	
NCE	NMRA	
Bachmann	NMRA	
Lenz	NMRA	
CT Electronics	NMRA	
Digitrax	Both/PROG	CV64 sets logic or function
SoundTraxx	NMRA	

**Table 2: List of which 21-pin standard the various manufacturers support. Updated version of a Mark Gurries table**

Control your Tortoises with DCC!



Dealer Inquiries Accepted



**TORTOISE**  
switch machine  
DCC decoder!

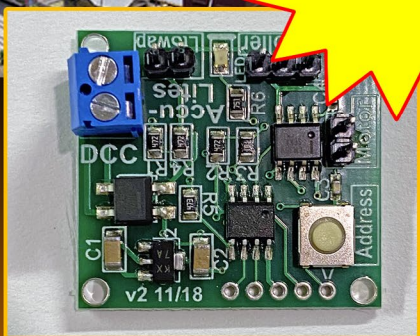

Tortoise DCC decoder ... easy to use and install! [CLICK TO LEARN MORE ...](#)

# END OF TRAIN DEVICE

**NEW SAFETY GREEN**



**Bright Red  
Flashing Light!**

Installs in minutes!  
No freight car  
modification required!

Patented Technology - US Patent 7,549,609

**Does not affect Load!**

↓ Car without Load ↓

↓ Car with Load ↓



[Click Here to  
Learn More](#)

**RE RING**  
ENGINEERING

The entire Next18 connector is only 8mm long and 5mm wide, making it extremely compact. However, the tiny connector's pins only rate at 500 milliamps, so track power (red/black) and the function common (blue), and the ground get allotted to two pins each [7]. This makes the Next18 effectively a 14 pin standard in reality.

The Next18 standard actually has two variations, the straight **Next18** in which pins 7 and 16 get used for functions, and the **Next18s** in which these two pins get used to drive speakers for sound decoders.

The Next18 the pins have been assigned following a symmetric-like design, so if you install the decoder backwards, no harm gets done

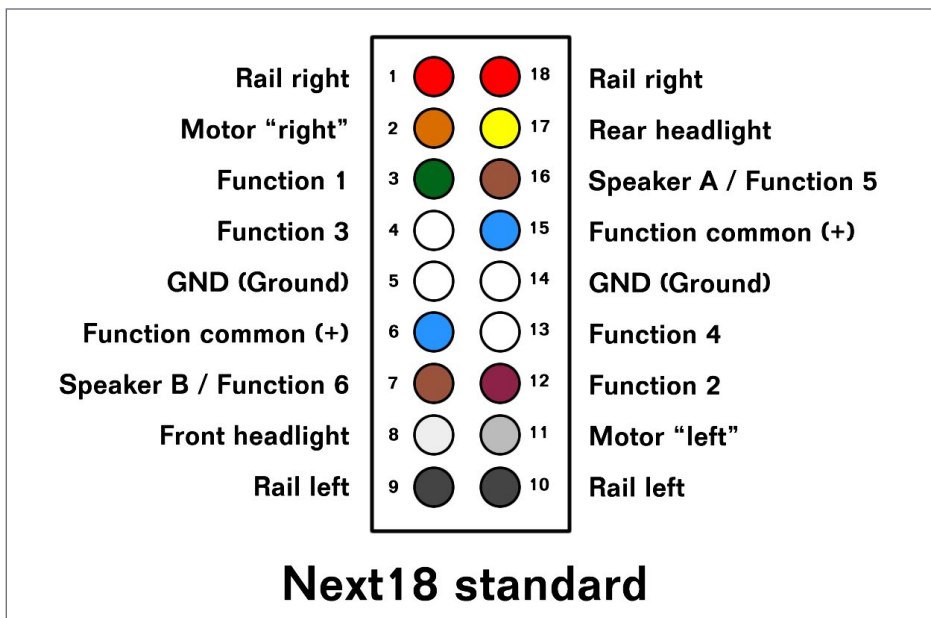

7. The pinouts on the Next18 standard are limited to 500mA each, so four key connections double up to allow for 1A. This means the standard actually only has 14 workable pins.



# Southern Digital

WWW.SODIGI.COM

Celebrating 25 Years of serving you !

## Complete wireless **Wi-Fi** Smart Phone Interface **Digitrax Zephyr Set** *Supports up to 5 phone throttles at a time!*

Software Downloads for both Android (Engine Driver)  
or Apple (WiThrottle) cell phones. Free Lite version or  
Advanced paid versions available.



• Engine Driver  
(support link)



• WiThrottle  
(support link)



**\$336.95** Value  
**\$265.00** Your Price  
**\$71.95** You Save

**DCC Conversions, Service & Support**  
E-mail: [sales@sodigi.com](mailto:sales@sodigi.com) (770) 929-1888



to either the locomotive or the decoder. It will not function correctly, but nothing gets “smoked.”

## The newest standard: PluX

Although the 21-pin MTC / NEM standard has become something of a defacto standard, there’s a new plug standard on the block that being promoted to replace the older 21-pin standard: PluX.

In fact, the NMRA has declared the 21-pin standard to be obsolete and they’re now promoting the PluX standard instead.

What’s interesting about this standard is it allows the plugs to have 8, 16, or 22 pins, but thanks to an index pin, they all will plug into the same 22 pin socket. Or for smaller scales, you can have a smaller plug socket to save space. That makes this standard very adaptable across the scales, a strongly appealing concept. The NMRA standard calls for three plug configurations: 8, 16, and 22 pins. The NEM standard replaces the PluX8 option with the PluX12 option instead.

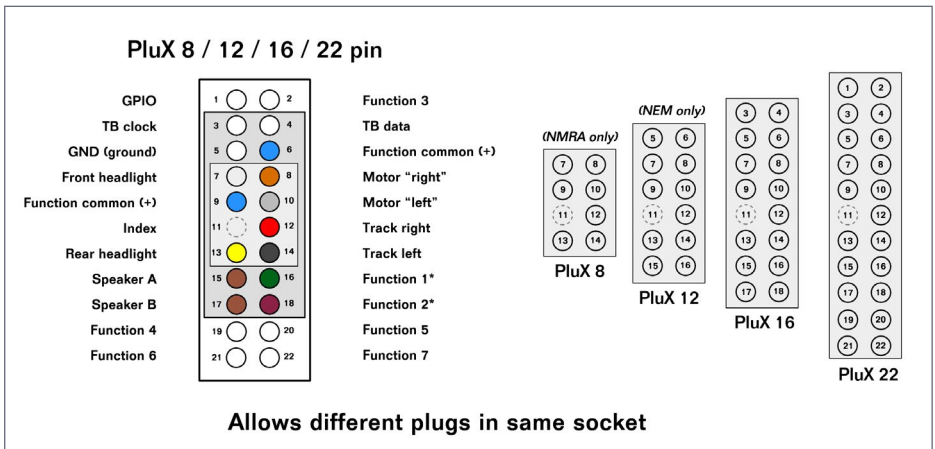

**8. The new PluX standard as defined by the NMRA and NEM 658.**



The smaller pin configurations allow for using a subset of the larger interface. In practical terms, the PluX8 standard offers no real advantages over the NMRA small / NEM 651 interface, so it's not included in the NEM 658 standard, being replaced by the PluX12 standard instead.

The standard also defines limits on decoder size, both footprint and thickness, allowing for plug-n-play decoders in all scales from Z-G.

You can read the full standard here:

NMRA S-9.1.1 standard (scroll down to section F):

[nmra.org/sites/default/files/standards/sandrp/pdf/s-9.1.1\\_connectors\\_2015.05.22.pdf](http://nmra.org/sites/default/files/standards/sandrp/pdf/s-9.1.1_connectors_2015.05.22.pdf)

NEM 658 standard (in German):

[morop.eu/downloads/nem/de/nem658\\_d.pdf](http://morop.eu/downloads/nem/de/nem658_d.pdf)

European manufacturers such as Roco, Fleischmann, Piko, Tillig, and Dapol have begun producing models with the PluX interface. ESU LokSound also has begun offering some PluX interface decoders and adapter boards.

The North American market, however, has yet to really embrace this new PluX standard.

## Converting between standards

What do you do if your locomotive is DCC plug-n-play, but it has the wrong plug socket on the motherboard? You use a plug adapter.

Table 3 provides some of the many options available for converting between plug standards.

## Most common North American decoder plug conversion options

Decoder-to-loco		Product	Vendor
From	NMRA small/NEM 651	6 to 8-pin	DCC Concepts
To	NMRA medium/NEM 652	harness	CM3 Models
From	NMRA medium/NEM 652	8 to 21-pin	DCC Concepts
To	NMRA 21MTC/NEM 660	adapter	
From	NMRA JST decoder	9 to 21-pin	Soundtraxx
To	NMRA 21MTC/NEM 660	adapter	TCS
From	NMRA 21MTC/NEM 660	21 to 8 pin	ESU LokSound
To	NMRA medium/NEM 652	adapter	

Table 3. Common North-American decoder plug to loco socket conversion options.



S

## Link

<https://mrhmag.com/magazine/url/6-8-dcc-concepts>

<https://mrhmag.com/magazine/url/6-8-cm3models>

<https://mrhmag.com/magazine/url/21-8-dcc-concepts>

<https://mrhmag.com/magazine/url/9-21-soundtraxx>

<https://mrhmag.com/magazine/url/9-21-tcs>

<https://mrhmag.com/magazine/url/8-21-esu>

*Did you see this article*

In **MRH** **RUNNING** **EXTRA** ?



**Build your own  
locomotive paint  
stand**

**Get the April eBook now**

← *click  
here*

# From first train set to railroad empire...

*Our complete line of DCC products  
grows with you. Discover the fun!*

- Designed and manufactured in the U.S.A.
- Preferred for ease of use and ergonomic design
- Unlimited scalability for any size model railroad
- Plug-and-play means more time running trains
- Great customer service and excellent support



## See your dealer



## Visit our new and improved web site for all your DCC needs!

- Get the latest new product announcements
- Watch our detailed how-to videos
- Browse the all-new Information Station
- Enjoy secure online sales, day or night!

Visit **ncedcc.com**



# MRH MARKETPLACE



INTER-ACTION  
Hobbies

Rail and Tie Craftsman Kits

*Its all in  
the details!*

**NEW!**



Boats  
Details  
Vehicles  
Structures

**HO Gas Meters**

Kit #HO-8003

**CLICK HERE**

[www.interactionhobbies.com](http://www.interactionhobbies.com)



**WEATHERING  
POWDER**

**MONROE  
MODELS**

[www.monroemodels.us](http://www.monroemodels.us)

**PRE-SIZE  
MODEL SPECIALTIES**

P.O. Box 6 Paonia, CO 81428

Ph. 970 527 4586

Made in The USA

Cast resin items for All Scales.

Tunnel portals, bridge piers, abutments,  
culverts, and retaining walls.

Trackside details and sage brush tree  
armatures.

"FREE SHIPPING see website for details"

**TAKE THE MRH SURVEY >>**

**CROW RIVER PRODUCTS**

**W** GOLDEN AGE LINE  
**WESTERFIELD**  
MODELS, LLC

**NEW KIT: AT&SF  
Fe-Q/Fe-R/Fe-V**



[westerfieldmodels.com](http://westerfieldmodels.com)



New Pewter Kits

"O" Scale Kit 355 E Steam Hammer

\$36.00

"O" Scale Kit 335 F Forge Crane

\$28.00

Made in USA

**HO & O Scale Machinery, Derricks,  
Engines, Hardware & Waterfront Models**

Pawtucket, RI 02861 Tel 401-723-0065

[www.crowriverproducts.com](http://www.crowriverproducts.com)

[MRHMAG.COM](http://MRHMAG.COM)

[INDEX](#)

[TABLE OF CONTENTS](#)

click me!

Pursuing  
Excellence



## THE TRAINMASTER, LLC

Detailed Craftsman Kits

[www.TheTrainMaster.com](http://www.TheTrainMaster.com)

**MONASHEE  
LASER  
ENGINEERING**

**COMING VISIT US  
CLICK HERE**

**OFFERING  
NEW SERVICES**

MANUFACTURERS OF RAILROAD  
STRUCTURES AND STEELING STOCK MODEL KITS

Take the MRH  
2020 Reader Survey ...



... and get a chance  
to win a 7" Kindle  
Fire tablet!  
(5 tablets will be awarded)



amazon

**TAKE THE SURVEY >>**

**click to learn more!**

**East Coast Circuits**  
Innovating Your Model Railroad Layout

P.O. Box 25412  
Providence, RI 02905

Lighting Circuits For Your Layout

Random Lighting Circuit - Burning Fire Circuit  
Traffic Light Circuit - Crossing Signal Circuit

Custom Lighted Vehicles  
HO & O Scale Emergency Vehicles  
HO & O Scale Trucks & Cars

[Eastcoastcircuits.com](http://Eastcoastcircuits.com)      [Eastcoastcircuits@gmail.com](mailto:Eastcoastcircuits@gmail.com)

**MOUNTAIN SUBDIVISION HOBBIES**

[www.modelrrsupply.com](http://www.modelrrsupply.com)

FREE USA SHIPPING OVER \$49.00

MRH Readers save with code:

**MRHMAG19**

**LOGIC RAIL™**  
TECHNOLOGIES

"Sophisticated  
Model Railroad  
Electronics"

Please visit our website and online store!

21175 Tomball Pkwy      Phone: (281)251-5813  
Suite 287      <http://www.logicrailtech.com>  
Houston, TX 77070      [info@logicrailtech.com](mailto:info@logicrailtech.com)

LOOK  
at what's new at  
Black Cat this month

Click here for  
our website

Etched brass  
CN 9 rung ladders  
for 8 hatch reefers

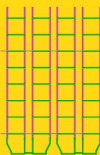

**Black Cat Publishing**  
(204)489-5005  
[ajfergus@mymts.net](mailto:ajfergus@mymts.net)  
[blackcatdecals.com](http://blackcatdecals.com)



**PRECISION DESIGN CO.**

**CUSTOM DECALS FROM  
YOUR OWN ART IN JUST ONE DAY**

**PDC.CA**

FULL COLOR & SOLID WHITE

**Model Railroad Control Systems**

Geoff Bunza Project Boards  
DCC Occupancy Detectors  
CMRInet Compatible Nodes  
Layout Telephone Systems  
RFID Switchlist Generator  
Switch Machines and Drivers





## BETHEL TERMINAL MODELS

Custom Painted & Weathered HO Scale Equipment  
Tru-Color Paint Dealer Stocking North East RR Colors  
We do Private Roads & Custom Decals

[www.bethel-terminal.com](http://www.bethel-terminal.com)

email: [mrh@bethel-terminal.com](mailto:mrh@bethel-terminal.com)

Have you seen these popular blogs on the MRH website?



## John Winter's PRR

108,000 reads

[CLICK TO READ IT NOW](#)

## Great Decals!™

FEC, Interstate, Virginian  
Railway, & L&N Titles  
After Hours Graphics Line  
Coupler Gages and More  
In O, S, HO, and N Scales

Your ad could be in  
this space for as low  
as \$88 a month.

*Click to learn more ...*



## Randy Seiler's B&O/PC

326,000 reads

[CLICK TO READ IT NOW](#)



# You asked for it: so here it is!

*Now available*

## *Best of MRH in paperback! (with no ads)*

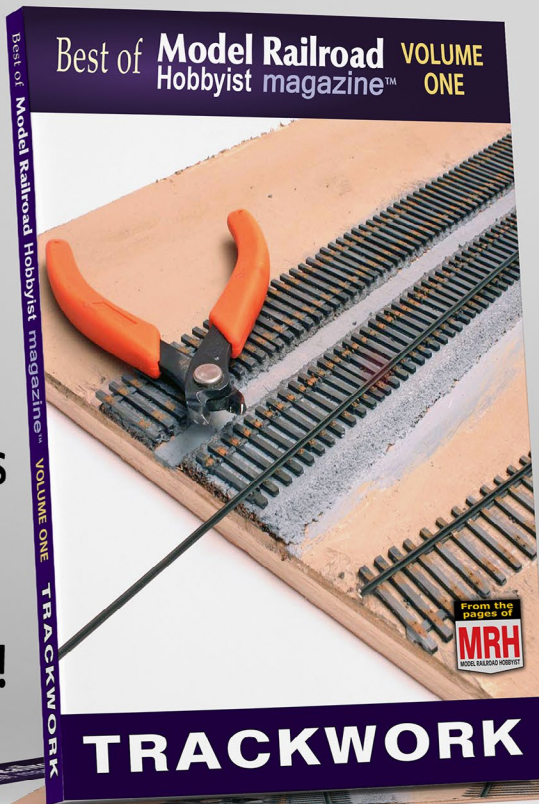

104 pages  
No ads.  
All meat!

~~\$29.99~~

**\$24.99**

FREE shipping US  
-50% shipping foreign

More volumes  
coming ...

### TRACKWORK



**Order my copy now >>**

[store.mrhmag.com](http://store.mrhmag.com)



# *Joe Visintine's* **East Bluff Terminal**

**THE MRH STAFF** *visits a 1970s freelanced layout inspired by the GM&O and Southern ...*

[MRHMAG.COM](http://MRHMAG.COM)

[INDEX](#)

[TABLE OF CONTENTS](#)



*Also on TMTV!*



**RATE THIS ARTICLE**

**MRH:** WE'RE VISITING WITH JOE VISINTINE ABOUT his East Bluff Terminal layout in St. Louis. Joe, take us back to your beginning in the hobby.

**JOE VISINTINE:** I first got started in the hobby with an American Flyer train set back when I was probably six or seven years old, running it around a Christmas tree. My dad bought more track for me and it just got bigger and bigger. Then it got put away as I got older.

Later I got into HO when my sister's husband bought me my first HO scale set, which was a Santa Fe. I did a 4x8 sheet of plywood with just an oval and started out with that. Then I progressed to another locomotive: I bought an Athearn Hustler. Those things are fast and great to play with!

I did another oval on the same 4x8, but I added a cross-over between the two tracks – I had some great wrecks with those! Then it all got put away during high school and during my time in the military, getting married, and working for a living.

Then back in 1985 while still in California, I ran across a modular club, the Monterey & Salinas Valley railroad. They were in Salinas and they had set up their modules in a mall. My wife and I were walking by and we saw their modular setup. I said, "Wow, this is neat!"

I started talking to these guys and the next thing I know, I'm a member of the club. So that got me back into the hobby and it just progressed from there.



2. A GM&O coal drag heads South after exchanging cars at the Peabody coal loader. We like the high-tension power line, something that's not often modeled this effectively.

**MRH:** That's so typical – you discover the hobby as a kid, drop out as you enter your adult life, then rediscover the hobby accidentally as an adult. Bring us up to date – how did you get from there to this layout here?

**Joe:** From the Monterey & Salinas Valley club, I also joined the Bay area S Scalers because I was an American Flyer fan – but they were scale S, not high rail. That got me into scale S modeling. We set up our modules at shows in Monterey.

We also went to Dunsmuir, California for Railroad Days and set those up for about six years. Plus, I became friends with a couple of other S scalers up in the Mount Shasta and Weed area.

From that group, and from the Monterey & Salinas Valley club, I met several members that used to be part of the Gorre &

Daphetid layout operating crew – you know, John Allen's famous layout. Unfortunately, I never got to meet John Allen or see his layout.

We had a round robin group on Tuesday nights that included three of the remaining G&D operators, which was interesting. The round robin group had HO scale layouts and we operated on them.

I finally talked my wife into moving back to the St. Louis area, so I joined the St. Charles model railroad club once we moved back here and built this house. I told my wife, you can have anything you want on the upper level, but the basement's mine!

So, I drew up plans for the basement, including an operators lounge, a storage room, a hobby work room, and the layout room. The layout room came to 44x15'!

**MRH: What is it you're modeling here in your basement?**



3. Trains from the north and the south terminate in East Bluff Terminal yards like the one shown here, where cars are sorted into locals to go out and serve the industries.



4. A St. Louis Terminal Railroad (TRRA) transfer run heads back across the river to St. Louis. You can clearly see the Mississippi River bluff strata in the background.

**Joe:** I call my layout the East Bluff Terminal (EBT) Railroad. It's a freelanced line running between the Illinois Bluffs and the Mississippi river. The EBT runs south of East St. Louis near the Gulf, Mobile & Ohio main line.

It's a "terminal" railroad rather than a through route. Trains come in from the north and trains come in from the south, they drop cars off, they pick cars up, and then they go back the same way they came in. That's what a "terminal" railroad does.

This is 1972 before the Illinois Central took over the GM&O. From the North the GM&O, L&N/Monon merger and the CB&Q come into East Bluff to transfer cars to local and Southern destinations. From the South the GM&O, SSW - that is, the Cotton Belt and the

## THE MANUFACTURERS RAILWAY

The Manufacturers Railway (MRS) in St. Louis, Missouri was wholly owned by the brewing giant Anheuser Busch (AB). The railroad switched the extensive AB brewery in south St. Louis, along with a few smaller customers.

The MRS had a half-dozen EMD switchers and was known for keeping its power in pristine condition.

Most of the beer was shipped on a Terminal Railroad Association of St. Louis (TRRA) transfer to Madison, Illinois where it went to the BNSF.

Foster Townsend Rail Logistics (FTRL) announced its intentions to take over operations once Manufacturers Railway ceased operations. On October 2, 2011, FTRL Railway began providing rail switching services at the St. Louis brewery. ■



Manufacturers Railway Alco S2 model designed for use with Trainz software. *Photo courtesy of [JointedRail.com](http://JointedRail.com)*



Southern/Central of Georgia merger drop off cars for local or Northern destinations. The SSW brings 57' reefers of produce from California.

Also, from staging an ADM train will come up from the South to switch grain cars at the grain complex and return to staging.

Lastly, we have trains come over from St. Louis across the river.

The St. Louis Terminal Railroad (TRRA) comes over and switches cars – and the Manufacturers Railway (MRS, also a St. Louis line) comes over with their beer cars and hoppers to switch. They send beer to the south or north, wherever they need some Budweiser!

That's what my layout includes.

### **MRH: Why did you pick this to model?**

**Joe:** Because it has a lot of operating potential. It's really nice because when trains come in from the north and you're switching the north industries, they're off the main line enough that you don't foul the main line while switching.

You can have operators on each end of town *and* you can have operators running the classification yard. We have the switcher that classifies cars that come in and we have the other switcher that feeds cars from another yard. When the next train comes, we'll have a switcher pull out the cars to be dropped.

This is basically the third time I have built the same layout concept. The last time it was in a 10x14' bedroom back in California. That previous layout used a double deck with a helix, which took up a lot of real estate.

I've made my latest layout all single deck and it's easy to operate because it sits along the Bluffs of the Mississippi River in Illinois

following a nice north-south orientation. We've got trains that come in from the north and south to drop off cars – and then pick up cars destined for their road and head back the same way they came.

The only regular through train we have is a passenger train.

This layout has a high scenery-to-track ratio, which I love. There's not that much track but I do have two opposing single-ended yards. It can be interesting to get both switchers, one on each yard, working together to feed cars back and forth.

The terminal concept worked well on my last two layouts – and it's working great on this layout, too. So why change something that works?

**MRH:** Why this particular era and not some other?



5. The one through train on the East Bluff Terminal is this GM&O passenger train, still running aging E units in 1971. The train is rolling to a stop at the East Bluff station.

**Joe:** I picked 1971 because I like the GM&O. I was sad when the Illinois Central took over the GM&O, so I stopped in 1971.

I try to maintain 1971, but there's probably a few pieces of rolling stock later than 1971. You need to know what you're looking at if you're going to be nitpicky about it. There might be a few automobiles newer than 71, but I tried to keep things the right date for the most part.

I don't do steam locomotives. I do model a steam locomotive at the depot that the East Bluff supposedly had back in the days when they were switching the yards. I put this steamer on display at the depot, but that's about it for steamers on my layout.

**MRH:** How difficult was developing the track plan for this layout?

**Joe:** I did my first track plan on the modular layouts with the Monterey & Salinas Valley. When I built my layout in a 10x14' bedroom, I just expanded it – and it worked great.

When I moved here to this big space that I have now, I didn't draw a track plan. I liked what I did for the last layout and it worked out fine, so I figured I didn't need a track plan because I know what I want. And that's basically how I came up with it.

What industries do I need? I can put an industry over here. I can put a power station here to take coal. So, I need a coal mine as a source for coal.

I initially put in a hidden track between the power plant and coal loader as an empties -in loads out operation during construction, but hiding the track would make the scenery unrealistic, so I removed the track. Avoiding that created more restaging effort but resulted in better-looking scenery.

**MRH:** So how many feet of main line do you have here?

**Joe:** As I've said, the layout is 44x15'. I only have a single track main line, which is probably around 95' long. It goes around in a circle through the Y at the room entrance forming a continuous run.

But usually, we just run a train from staging into the yard and back. We never do continuous running during an operating session.

**MRH:** Okay, great. What's the minimum radius on this layout?

**Joe:** When I was laying the track on this layout, I used metal gauges. I used a 32" radius and a 36" radius to help me with my curves. I also used a straight metal guide.

I may have situations where it's less than 32" but nothing that's under a 28" radius.



6. This GM&O freight waits in the siding for the passenger train to arrive. Meanwhile, passengers wait outside on the platform since their train should be arriving any moment now.



7. The passenger train finally arrives and draws slowly to a stop at East Bluff. Number 100, the one remaining East Bluff steam loco saved from the scrapper's torch, quietly reminds us of a bygone era on this line.

**MRH:** As to turnouts: you use #4s and #6s. Any #8s?

**Joe:** When I was doing trackwork for the staging yard, I used track salvaged from my layout in California – Peco code 100 and Peco #4 turnouts. On the layout I went with code 83 from Micro Engineering. I use their turnouts as well everywhere, and they're all #6.

**MRH:** So, what's the ruling grade on this layout?

**Joe:** The grade does not exceed 2%. The benchwork varies anywhere from 50" to 56". We double-head every train we operate, so you have two locomotives. When they end their run in a yard, they have to go back the exact opposite direction.

So, an engineer just gets out of one locomotive, goes into the one on the other end and he's heading out the other direction.

The 2% grades don't present any problem with two locomotives on each train.

**MRH: What kind of track are you using?**

**Joe:** I'm using Micro Engineering code 83 with their #6 turnouts. Micro Engineering later came out with their more compact yard ladder track system too late for me to use. I said, "Man, I should have waited a little longer!"

The #6 switches work okay but I sure would have used the more compact switches if they would have been available.

**MRH: How did you set the layout height?**

**Joe:** I determined the layout height based on the duck-under. So, I asked, how low can the duck-under be?



8. Joe's layout height is from 50" to 56", or just above waist height for many people. As you can see, the attractive, carpeted, nicely lit layout space is very inviting.



9. When you enter the layout room you bend under this 4'-6" permanent duck-under bridge. Joe has added thick foam padding so any accidental bumps remain relatively painless.

I'm 6'-4" and my bones are getting cranky about bending over and bending down. So, I set the duck-under as high as I could without visually impacting the layout for people with a shorter height.

I want it so an average-height person can come in, look at the layout, and see everything on it.

I chose a duck-under because I didn't want a removable bridge, a swing bridge, or a tilt-up bridge. Those things to me are tedious.

Some guys have great luck with something removable, but you need good strong hinges. My friend Bill Young up in Mount Shasta scratchbuilt a three-track bascule bridge in S scale and he motorized it. When entering the layout, he just pushes the

button and that bridge goes up. Then it comes back down and it sits right square on the tracks with no derailments.

People like that are very admirable. How can you top that? But it was something that I really didn't want to do – I didn't want to fool with it.

And so, I just built the duck-under. It's built strong and fastened solidly to the wall. It's padded underneath, so you're not going to hurt yourself going through it.

**MRH: That makes sense. When, then, did you start construction?**

**Joe:** I started this layout in January of 2014.

I finished the basement out first. The only thing the builder put in was a spare bedroom and a full bath. I wanted an operators



10. A Southern freight train passes the Peabody coal loader South of the EBT yards. The Peabody loco number 703 is busy moving Commonwealth Edison cars to be loaded.



lounge, a storage room for all our stuff, plus a “dirty” room, and a modeling room. I did get some help finishing the basement.

I did probably 85% of the construction in the basement and probably 95% of the construction of the layout.

I did the benchwork, the electrical, the trackwork, the scenery, pretty much everything. I did have a couple people help me with ballasting. A friend of mine built one of the bridges.

But basically, if you want it done your way, you pretty much have to do it yourself.

## **MRH: Did construction go as expected?**

**Joe:** Building the layout went fairly smoothly. There were things that I wanted like a dip in the scenery, so that benchwork went a little bit lower for the bridges to cross.

I did have to change some things as I went along. My caboose storage track didn't work out and I had to remove the caboose track turnout and move it to another track.

When I put the main line in, I realized I needed a siding by the main line so another train can get through while the passenger train is at the depot.

Adding that extra track meant I had to add some framework to bring the front of the benchwork out, and then frame that up so I could attach the fascia to it.

I built the turnout control panels myself. I copied the trackwork onto the panel, drilled the holes where needed, then put bipolar LEDs in to indicate the direction the switches were thrown.

I used Tortoise switch machines on the Micro Engineering turnouts. They're all #6 using Micro Engineering 83 code track.

My staging yard is all Peco code 100 with Peco number four turnouts. Twin-coil machines run that through a 52-diode matrix. A homemade capacitor discharge circuit powers the machines.

**MRH:** What are your thoughts on doing scenery? Do you have any favorite methods?

**Joe:** Doing layout scenery wasn't always easy, but it was interesting.

I use SuperTrees, a nice product but you do need to pay attention to the preparation process. First I had to get all the seeds out of the sprigs. Then I had to soak the sprigs in matte medium and hang them upside down with a weight to get them to straighten out.

And then I painted trunks and used hairspray to hold the sprinkled ground foam on them. Some time they still have a curve to them. I found out with SuperTrees you can take a hot soldering iron to the curve of that trunk and straighten them right out and get a tree to stand up straight.



11. The Union Electric power plant has an ample water supply from the Mississippi river. The kit is a left over from the layout in California.



**12. The East Bluff Terminal includes a lot of on-line industries that serve as destinations for all the traffic that comes from the north and the south.**

My brother helped me put the drop ceiling in the basement down here, so I had a lot of tiles left over. I was looking at modeling the river bluffs and I started thinking the tiles could make great bluffs, along with some rock castings.

I took the ceiling tiles, cut them into strips, and shaped them into various jagged angles. I hot-glue them together, then take a real stiff wire brush and scrape it along the sides. Those wires gouging into the side of that ceiling tile makes some beautiful strata.

I paint them with black and dark colors, then dry brush them in light colors. I use five different acrylic colors to paint them with.

I do the same to paint the rock castings after they're put in. You put a rock casting here and place another one next to it but you get a gap. I've gone through a lot of Sculptamold and a lot of

dental tools just trying to fill those gaps and keep the look of the rocks consistent.

It's fun, actually. You can reuse the same casting – you just turn it upside down or whatever. I have the same three castings within inches of each other and it's hard to spot them.

## **MRH:** What do you do for backdrops?

**Joe:** I'm using very simple backdrops on this layout. When we got the house, the basement walls were studded, so we just put drywall up and taped it. Then I went like to Home Depot, found a nice blue, and painted the layout room walls blue. And that was it, that's the backdrop!

I thought of painting some clouds on it, but that's never happened yet. I've got a book on how to paint clouds that I've looked



13. The EBT purchased an Alco S2 from the GM&O and only replaced the lettering. It was never repainted to the green and yellow.



14. Here's a closeup of RS1 #401, also seen in [13], sporting the new green and yellow EBT paint scheme.

through, then just put back on the shelf. I said, I'll do that later. Maybe it's time to finally do some clouds.

**MRH:** What kind of locos do you use? Do you have a particular brand that you prefer?

**Joe:** My locomotives are a mix of manufacturers. There's Athearn, there's Atlas, and that's pretty much it. There might be a Walthers loco in there, too.

**MRH:** What about the rolling stock? What sort of rolling stock does your layout have, and do you have a preference there?

**Joe:** My rolling stock is a mixture of just about every manufacturer you can think of. Most of them are 50', I have very few 40' cars.

There's a mixture of coal cars from Commonwealth Edison that the GM&O Historical Society produced one year. In fact, I have a lot of

GM&O cars that the society has produced such as covered hoppers for the grain peninsula.

But I have just about any make of car that's out there. They do all have Kadee couplers and metal wheels though.

**MRH:** What kind of structures do you have on this layout? Do you kitbash? Do you scratchbuild? Do you use a lot of wood structures or brick structures? Do you have certain kits you like, such as Cornerstone kits? Tell us about your structures.

**Joe:** I'm using a mix of structures. I'm using Walthers kits, and a lot of Pikestuff. I also have a few things from my first 4x8 HO layout, from Revell.

Many of my structures, I use them as manufactured or as they were supposed to be built.



15. Joe has several bridge scenes on his layout. This is one of the more dramatic and represents a Mississippi river estuary along the EBT's east riverbank route through the state of Illinois.

But I did make some modifications, like the grain elevator has more silos than the kit does. Several of my structures have been kitbashed using DPM brick modular walls. I just put them together in any fashion needed to make some huge industry buildings.

The Union Electric power plant is a Korber kit. The Peabody coal mine coal loader comes from Walthers. For my engine house, I can't remember the manufacturer but I added the car repair shop to it as a kitbash.

Most of the buildings behind the two yards I pretty much kitbashed or scratchbuilt from different parts. I used the office building on the grain elevator as is, but I scratchbuilt the corn syrup plant and the lumber yard. For the propane dealership and the storage warehouse, I pretty much built them right out of the box.

**MRH: How about the bridges on the layout? How have you done those?**

**Joe:** I only have two significant bridges. One bridge, I believe, is a Micro Engineering kit and the other bridge is a Pikestuff concrete bridge. The overpass in the yard is a Pikestuff concrete bridge.

Oh, I do have an Atlas bridge, where I used the deck girder bridge sides. I put those together and ballasted the track on top of that. So, there's basically four bridges on the layout, I guess.

Wait, there's also a bridge over by the town area near the duck-under.

**MRH: What control or DCC system do you use and why?**

**Joe:** When I joined the St. Charles model railroad club, they used Digitrax and they operated all the turnouts with the throttle. But the Digitrax just seemed a little too much for me. I like the NCE system, it was a little simpler. I can just hold it with one hand and operate it. It just seemed like a nice product, so I went with NCE.

I've got a ProCab and a PowerCab. I have three cab 06s and a cab 04. NCE works very well for me.

**MRH: Do you use tethered or wireless throttles?**

**Joe:** My NCE system is all wireless. I bought it without it being wireless – and then I thought, I don't want these plug-ins all over the fascia. It distracts from running the trains.

So, I just went wireless.

**MRH: What kind of decoders do you use and why?**

**Joe:** Most of my locomotives are equipped with NCE decoders and they're not sound decoders. I have very few sound decoders on the layout.

A few sound decoders I have on the layout are QSI. There may be another brand of sound decoder too, but mostly I'm using silent running NCE decoders and they work fine.



16. In this scene, the EBT line uses a through girder bridge to pass over a roadway along its southern route.





17. Joe loves running trains with his wireless NCE DCC system. Here he's switching the large grain elevator scene that dominates the only peninsula on his layout.

**MRH:** Do you program your decoders on a programming track, do you program on the main, or do you use JMRI?

**Joe:** When I program a fresh decoder installed in a locomotive, I'll take it into my office. I have a program track there hooked up to the computer and I use JMRI to do the programming. Using JMRI is pretty simple and it goes pretty quick.

The hardest part I have is getting locomotives speed matched because I'm running double-headed on all the trains. I still haven't conquered the speed matching – I still have trouble with it.

**MRH:** What do you like most about your layout?

**Joe:** The thing I like most about the layout is its appearance. When you walk in there, you see something that's – I'll use the term loosely – museum quality, at least that's my definition of it.

With the skirting, the carpeting – it all looks very finished. But actually, a layout's not really finished. I started this thing six years ago at the door duck-under – and went in a clockwise direction around the room, putting in buildings and scenery and details.

I finally got back around to the door, but I still have about two square feet of scenery to do that's not finished.

Once I get that done, I'll start at the door again and just keep going around doing more detailed work. I've got lighting to do, I have cars to weather. I have more roof detail to add, and just more small details to add. But I really like doing that.

I'm down here almost every day and working on it.



18. This view from the end of the layout peninsula shows the extensive grain elevator facility served by the EBT along its northern line. The considerable switching needed in this facility can take a good part of an operating session.

**MRH: What do you like least about this layout?**

**Joe:** Man, that's a tough one. If I had to choose something that I like least, I would say the skirting. I installed the skirting in eight-foot sections. If you want to reach for something under the layout and it's in the middle of an eight-foot piece of skirting, it can be easier to just take the skirting down because it's going to be in the way.

But other than that, there's nothing I don't like about the layout, except maybe it could be bigger. But then when I think about it, it's actually big enough for me.

**MRH: What would you say has been your greatest challenge in doing this layout?**

**Joe:** I think the greatest challenge was programming all the turnouts for the yards on the layout.

I purchased Digitrax DS64s to program all the turnouts in the yards into a matrix. However, I use North Coast Engineering for my control and North Coast Engineering will not talk to the Digitrax DS64s, so I had to go out and buy a little Zephyr to program the DS64s.

The DS64s are a completely different source from the NCE and they're all on a different power supply that powers the turnouts.

**MRH: Any other nasty surprises with this layout? Any totally unforeseen headaches?**

**Joe:** I have been fortunate with building this layout. I have never experienced anything that was disastrous or that wasn't easily repaired or changed.

When you build the same thing for the third time, you kind of know where you're going. As I said, I did encounter a couple surprises, but they were minor things that caused maybe a two- or

three-week delay. Once I figured out the solution, they were not that hard to fix.

Oh yes, one other surprise was how many cars I could get in a classification yard or in the departure yard. I could get more cars in the on-layout yards than I could get into staging.

So, I thought, well, I do need to keep these operators busy, so I need more cars on the trains. I just lengthened the staging yard tracks to give me more cars on a train and give these guys more work to do!

**MRH: What's your least favorite part of doing a layout?**

**Joe:** Well let's see. Doing the layout has been very satisfying to me since it's the third time I've used this same configuration. When it's the third time you build a similar layout, you're pretty experienced in doing benchwork construction, doing electrical, doing scenery, and things like that.

Maybe 5% of the things on my layout now came from the previous layout in California. I am very comfortable in doing everything myself, especially the wiring. I did wiring for Western Electric in Chicago when I worked up there. They want their wiring to be neat, clean, and traceable. So that's how I do my wiring. I use a lot of zip ties to cable the wires together.

In building this layout, I have enjoyed everything in it. I can't think of anything that I disliked doing in building this layout. The benchwork, the trackwork, the wiring, installing switch machines. I enjoyed all of it. There's hardly anything that I disliked doing.

I did hand off a few things that I could have done myself. But my friends wanted to help so I gave them things to do and appreciated their help. It's great to have friends who want to help.



19. Joe has a significant staging area outside of his layout room, feeding trains to his East Bluff Terminal's industries from lines both north and south of St. Louis.

But I don't want to lose control over how things look – I'm picky about stuff like that.

**MRH:** So, what are your thoughts on layout size and this layout – can a layout be too big?

**Joe:** Layout size must be determined by who's building it. If they want just a small layout that's fine. If that's all they're comfortable with, then enjoy it. Other people have huge layouts that fill their basement and go on forever.

Huge layouts are great for a group of guys who want to come in and run trains and switch cars. I could use more of this basement and have a bigger layout, but 44x15 is big enough for me to handle, to keep clean, and to keep operating.

**MRH:** Speaking about keeping things clean, what's your track cleaning method? Or your wheel cleaning methods?

**Joe:** Trying to keep the layout clean can be a challenge with the dust and everything. To clean the track, I use a locomotive and two cars with metal rollers using Handy-Wipes around them.

I soak the first one with mineral spirits and then I push them both around the track. The first one gets the track wet with the mineral spirits and the second dry one picks up the dirt.

I run the track cleaning consist around the main line in the yards and in the staging yard.

To deal with the dust problem, I've heard that someone took a box fan and they taped a furnace filter onto the fan. They just run the fan in the room to circulate the air. The air comes through the fan and catches the dirt on the filter, which is a good idea. I built one, but I probably don't use it often enough.



For cleaning the equipment, I have a one of those brushes the guys use to put the shaving cream on with. It has

20. Joe uses this 1:1 clock during his operating sessions. This prominent wall clock can easily be seen from anywhere in the room.

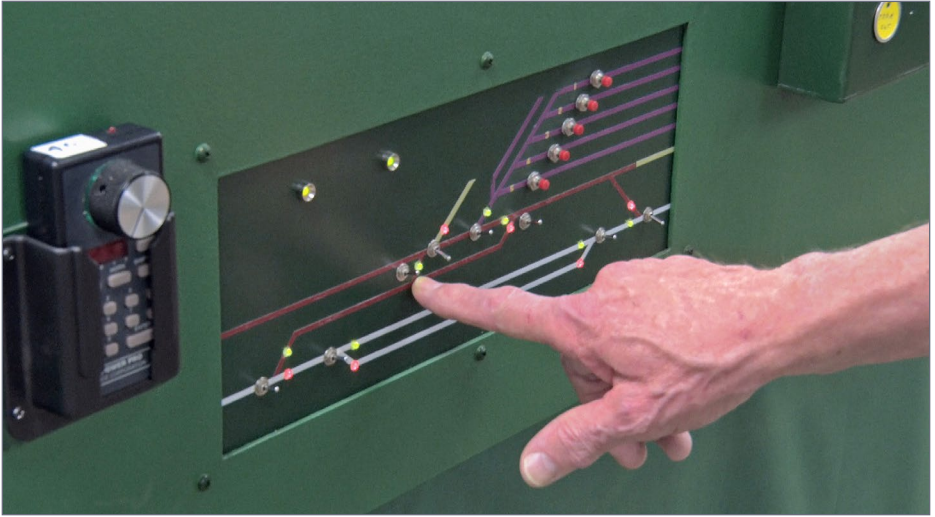

21. Joe has built a number of turnout control panels at strategic points along the fascia. In the yards, he uses a DCC matrix routing system so you just select the track you want and the system throws all the turnouts needed to reach that track.

very soft bristles. I use that brush on the top of the cars and on structure roofs to dust things off.

**MRH: Do you host regular operating sessions? How are they working?**

**Joe:** We have operating sessions at least once a month, and we hold them on a Tuesday night. We start around six o'clock and we're done by nine o'clock.

I'd like to have more op sessions, but I'm still working on the layout and trying to get things done too.

The guys love coming over here. I have five positions that need to be filled. They decide among themselves what they

want to do. Then they grab a throttle, dial in the loco number, and start running.

It's fun when somebody does something wrong or it derails – we get on each other a little bit, but it's all in fun! It's about having fun with your friends.

**MRH:** When you host operating sessions do you get to run trains?

**Joe:** During an operating session I may run a train. I have a situation where we'll bring the ADM grain train through and park it on a siding in front of the depot. Then I let it sit there until the passenger train comes in from the other direction.

Once that happens, the grain train can go on to the north end and switch out the cars there. I will do the passenger train and let the guys switch the grain train.

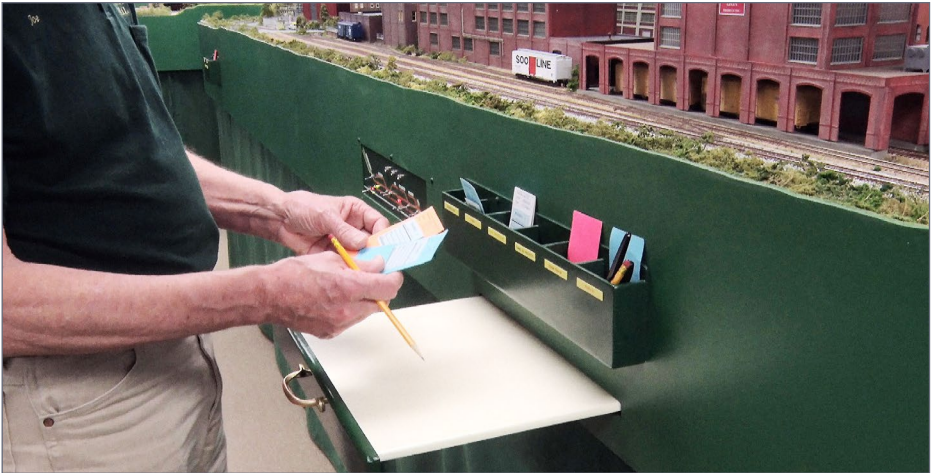

22. Joe has built these clever slide-out drawers at key switching locations to aid managing and sorting cards as you work the industries.



I also have one optional run-through freight that can go either north or south. Once it runs around the layout it goes back into staging – that works to just to have something else moving on the layout.

**MRH: Are you committed to HO or would you ever consider doing a layout in a different scale or gauge?**

**Joe:** As far as gauge of trains and scales, I like HO because you can get more into the space. N scale is just too small for my old eyes. Like I said previously, I was in S scale for a while.

In our house in California, I don't know how I got by with it, but I had a soffit running all the way around the living room and I had two tracks of S scale trains running up there. One was a passenger train and one was a GM&O / Baltimore & Ohio freight train.

It was neat to have trains running up there, but there was no switching. It had no switching or anything. They just ran in circles around the room.

I still have a lot of S scale trains and hopefully one of these days I will build a soffit in the office with two tracks. Then I can run my S scale trains because I don't want to give them up – I still like them.

**MRH: What sage advice might you give to someone just starting out in the hobby?**

**Joe:** To someone just starting out in the hobby, try to find a model railroad club in your area. Join and learn from these guys.

Start out simple if you build anything for yourself. If it's a four by eight sheet of plywood it doesn't need to be fancy, just little more than an oval. Lay down some track, run some cars, learn how to put in a decoder if you want to go with DCC – or just stay with DC. Put in a turnout to see how that works.

Figure out how to do electrical work, how to run wires, and what size wires to use. How to do this can all be obtained on the Internet – or it can be learned through comradery in a club.

If you're on your own, just start doing the hobby and learn on your own. Figure out what works for you, what doesn't work for you.

If you've got questions, you can find answers on the internet. If you have friends that are doing a model railroad in a different scale – go help, it doesn't matter, it all works the same.

**MRH:** What do you hope convention-goers get out of coming to visit this layout?



**Joe:** I will have my layout open for the NMRA National convention in July. And when people come in, I want them to think, yeah, I could do this.

I like to show that they can do the same thing or even better. I really like this *Trains of Thought* from Tony Koester, it's what I go by, my philosophy of the hobby. Can I share a little of it?

**MRH:** Sure, go ahead and tell us what Tony said.

**Joe:** When people come to see my layout, I want them to see what's possible and be inspired to try the hobby themselves. I learned this from Tony Koester a long time ago.



I printed this up from an article in *Model Railroader* that he wrote.



**Also on TMTV!**

23. Joe Visintine's East Bluff Terminal is a great example of what can be accomplished as a plausible freelanced route. Even though the EBT itself is freelanced, Joe cleverly connected to various favorite prototype lines such as the GM&O, a particular favorite of Joe's.

Tony says, “This hobby isn’t about playing with toys. It’s about enjoying the magic of railroading by building and operating scale models in a manner that captures the essence of the prototype. To what extent you do that is your choice. But understand that those hobbyists who do it extremely well are simply showing the rest of us the opportunity that lies ahead.”

And to top it off, he autographed my printout at the 2000 convention in San Jose!



*Also on TMTV!*

## TRACK PLAN?

*For a track plan of Joe Visintine's East Bluff Terminal, visit this month's [Bonus Extras](#).*

***Did you see this article***

In **MRH** **RUNNING** **EXTRA** ?



**Wine as a layout industry and traffic generator**

**Get the April eBook now**

← *click here*

## JOE VISINTINE

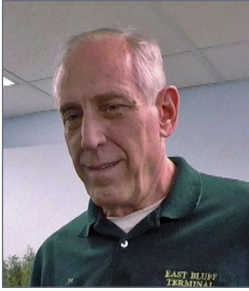

Joe was born in East St. Louis, Illinois and watched the Arch being built while riding the bus across the Eads Bridge on trips to St Louis. He was drafted into the army after high school and served a year in Vietnam and a year in Germany as a radio and relay tech. His parents moved to Elwood, Indiana during his

term in the service. From Elwood he went to Chicago working for Motorola and Western Electric. He was transferred to California in 1971. After WE closed its plant in Dublin California, he joined General Electric repairing and calibrating radiation detection equipment.

Joe decided he didn't like being around plutonium and cobalt 60 and quit his job. He hired on with a construction crew doing concrete and remodeling homes. When the interest rates went up in the '80s with the housing market slump, Joe hired on as an installer for Culligan installing water treatment equipment for homes and industries in the Monterey Bay area. After a few years of night school and getting certified for water and wastewater operations, he was hired by the City of Watsonville in water operations for 19 years and retired as senior operator. He organized the City's water sampling program to comply with state and federal regulations.

Joe and his wife Denise left California in 2012 to return to the St. Louis area to be with his remaining brother and sister and their family. They have a son Roman and a granddaughter Audrey who live in San Jose, California. ■

# FAST TRACKS

Build your own trackwork easily, quickly, and affordably.



## TRACK BUILDING SYSTEM

★★★★★  
Precision milled pockets accommodate PC Board ties that are soldered to the rails.

★★★★★  
Track slots ensure perfect alignment while soldering the rails to the PC Board ties.

Each turnout fixture can be used to construct both right and left turnouts that are DC and DCC compatible.

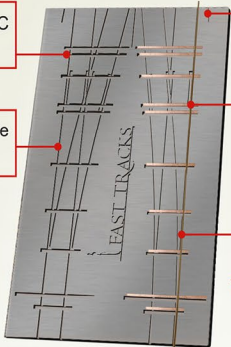

★★★★★  
Guard rail forming grooves are provided to precisely shape the guard rails.

★★★★★  
PC Board ties are soldered to the rails using a standard 35 watt soldering iron.

★★★★★  
Rails are inserted into the fixture right side up, making it easy to confirm alignment.

★ Fixtures are machined out of a solid piece of high grade 6061 aluminium stock and will last for thousands of uses.

Turnouts are built using pre-cut PC Board ties dropped into pockets cut into the fixture.

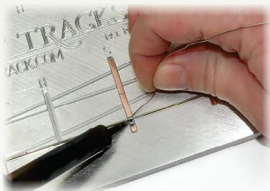

Held in precise alignment, rail is then soldered in place onto the ties.

The Fast Tracks PointForm tool makes it fast and easy to file perfect frog and switch points for the turnout.



Just insert the rail into the tool and file.

Finishing the turnout is simple with QuickSticks laser cut wood ties.



Simply glue the soldered trackwork to the wood ties, break off the frets, and your turnout is ready to be installed onto your layout!

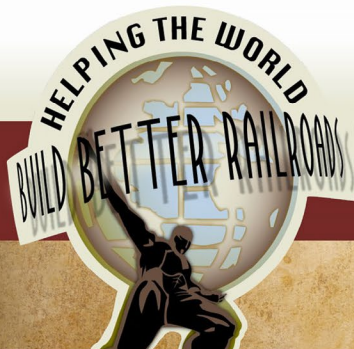

All Fast Tracks track fixtures and tools are NMRA compliant



• Easy ordering •

**Earn Waypoints with every purchase**

shop online 24/7 [handlaidtrack.com](http://handlaidtrack.com)

1-888-252-3895 [service@fast-tracks.net](mailto:service@fast-tracks.net)

# Walthers Trainline track cleaning car upgrade



Model Railroad Hobbyist | April 2020

1. The Walthers track cleaning car straight out of the box. Unfortunately, the rather squat car body makes it stand out rather than blend in!

**STEPHEN KAY** improves the Walthers track cleaning car ...

**PROBABLY THE MOST IMPORTANT ITEM ON OUR** turnouts layout maintenance list needs to be keeping the track clean. For many years I used a homemade hardboard slider car to keep my track clean and dust-free.

Recently, I discovered a Walthers track cleaning car at my local hobby shop, painted for my favorite road, the Union Pacific. I picked one up to give it a try. My plan was to run the car on regular freights as an added way to keep track clean.

**RATE THIS ARTICLE**

When I got the car home and put it on the layout, I noticed a problem immediately. The car itself runs well, and the heavy diecast frame does a nice job, but I found the car body to be very low and squat [1].

The car stands out among my standard height cars – calling far more attention to itself than I want. To add insult to injury, the car has the wrong color – the UP used a much more reddish box-car color.

I decided to replace the car body so it blends into my trains better. This upgrade turned out to be a relatively simple project.

## Fixing the squat car body

As the first step, I chose a body from a donor kit. I wanted something relatively nondescript, so I went with a typical car my hobby dealer had on the shelf – in this case an Accurail #3104 Soo Line plug-door boxcar.

I was somewhat familiar with this model, and could use the left-over underbody on other projects, as it fits perfectly in the Trix/Marklin series of boxcars that came out a few years back.

Note: The Trix/Marklin boxcars are nice cars, but they have the funky European-style swivel couplers and deep pizza-cutter flanges. But the Accurail underframe fits perfectly onto these bodies and converts them to NMRA standards in minutes.

## Adjusting the underframe

I only needed to make a few adjustments here.





2. I glued a 0.060" styrene strip with CA to each end of the Walthers car underframe so it just fits into the Accurail shell.

First, I found the Walthers underframe to be slightly shorter than the Accurail frame. I measured a difference of 0.120".

I lengthened the underframe by attaching a strip of 0.060" square styrene to each end of the underframe with CA [2]. This turned out to be a bit oversize – but a few swipes with a file took care of this.

If you choose a different replacement body, you may need to use a different size strip. After I got everything to fit properly, I painted the styrene black.

With the underframe length taken care of, I looked into dealing with the higher car body. I used 0.125" x 0.250" styrene as blocks inside the car body to hold it at the correct height [3].

I used what I had on hand, the exact size styrene strip size doesn't matter that much. Figuring out where exactly to attach the blocks was more of a problem!

I wanted the carbody to ride at the same height as other Accurail cars, but I had trouble figuring how far up the inside of the shell to attach the styrene strips to get this.

I had to experiment to figure this out. I put two Accurail boxcars on the track with the Walthers track cleaning car underbody between them.

I put a spot of Testors plastic tube cement on each styrene block and gently stuck them to the inside of the car body ends as far down as possible. Then I placed the body on the Walthers under-frame and, using both hands, carefully pushed the car body down until it rode at the same height as the cars on either side.

I removed the body, and evened up the blocks by making them both level and at the same distance from the bottom of the car body.



3. Fitting these styrene blocks inside the ends of the shell turned out to be trickier than expected. These blocks establish the height of the shell above the rails – see the text for details.

I let things set up for a few minutes and then put the body back on the frame. If all is well, use liquid cement to firmly attach the blocks to the body.

If not, I popped the blocks off the car body and tried again. It took me a couple of tries to get this right.



After the cement sets up, the car should ride at the correct height.

I found the body needed one more modification: the Walthers shell is held to the underframe with two styrene tabs molded to the inside. These fit into small recesses in the underframe.

I replicated these tabs using a couple of short pieces of 0.030" x 0.100" styrene [4]. I put the Accurail body onto the Walthers underframe and then simply cemented the tab strips in place with liquid styrene cement.

**4. Fitting these styrene blocks inside the ends of the shell turned out to be trickier than expected. These blocks establish the height of the shell above the rails – see the text for details.**

Walthers uses cast metal for the body, so it won't stick to the styrene tabs, and you will be able to remove the body if needed. I filed a taper on the edge of the tabs to make it easier to remove the car body. I painted these strips to match the car body.

## Final steps

Because the replacement body ended up longer than the original car, the couplers needed to be extended.

I replaced the Walthers factory couplers with #1013 Accumate couplers. I had a little trouble making this change, but not for the usual reasons.

The heavy, diecast underframe of the Walthers car has its trucks mounted in rubber grommets inserted into the casting. I was unable to get the trucks off! Mounting the couplers with the trucks in place was a little fiddly, but it was doable.

Once the couplers were installed, I reassembled the car and tested the coupler height, which was properly to spec. I also found the

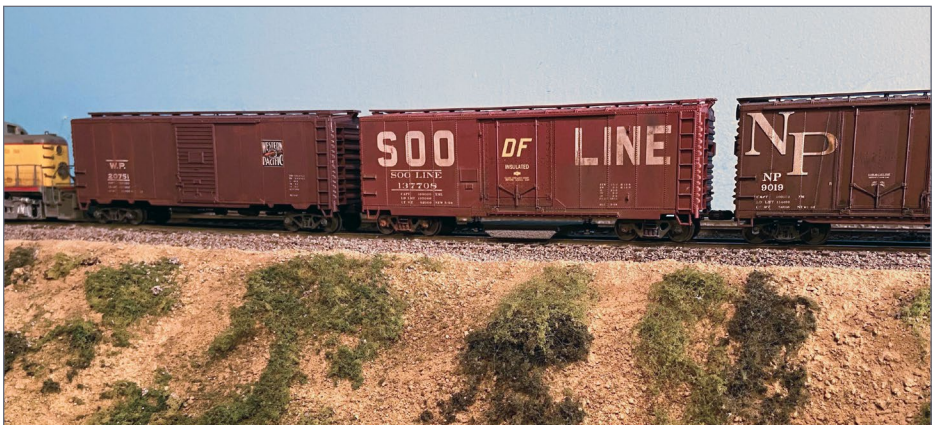

5. The car with an Accurail body in place – now it blends into the train much better.

wheels in the Walthers trucks to be in gauge and free rolling – although the car, with the track cleaning pad on the rails is not!

I painted the trucks and gave the car a light weathering with powders. With it all complete, I put my modified track cleaning car back on the layout.

My upgraded Walthers track cleaning car helps keep my track clean without drawing attention to itself. It blends right in and rarely gets noticed – which is exactly what I wanted.



## STEPHEN KAY



Steve Kay got interested in model railroading in 4th grade, when he took out a copy of *Making and Operating Model Railroads* by Raymond Yates, from the library at Oakville Elementary in Mayfield Heights, Ohio.

Starting with several small, 4x8 layouts, Steve has since built a number of larger railroads, and has a “pretty-much finished” 21’ x 11’ HO Union Pacific in his basement. He likes to build structures and freight cars, and now in the planning stages for his next layout.

When not building models, Steve works as a docent at the Cleveland Museum of Natural History. He also has acted in over 40 plays at local theaters and directed a few as well. ■

from the  
**Model Railroad  
Hobbyist** *Store*

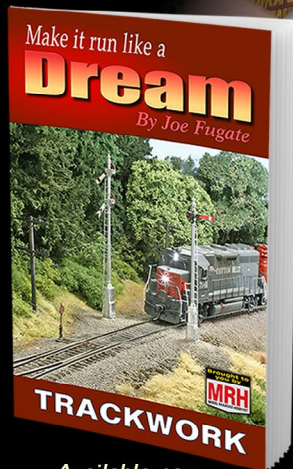

Available now

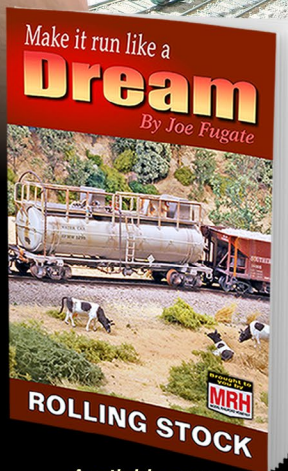

Available now

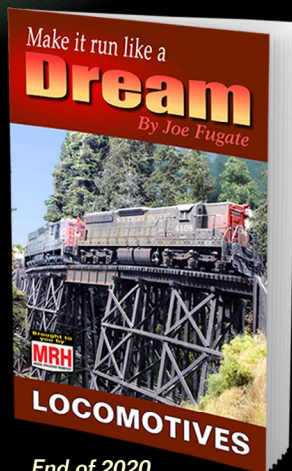

End of 2020

★★★★★ 5/5

"These books are remarkable and very well done."

- James S.

**Buy now and get special pricing ...**

PAPERBACK BOOKS: FREE SHIPPING US - 50% OFF SHIPPING FOREIGN

eBook download  
or  
Paperback book

Make it run like a  
**Dream**

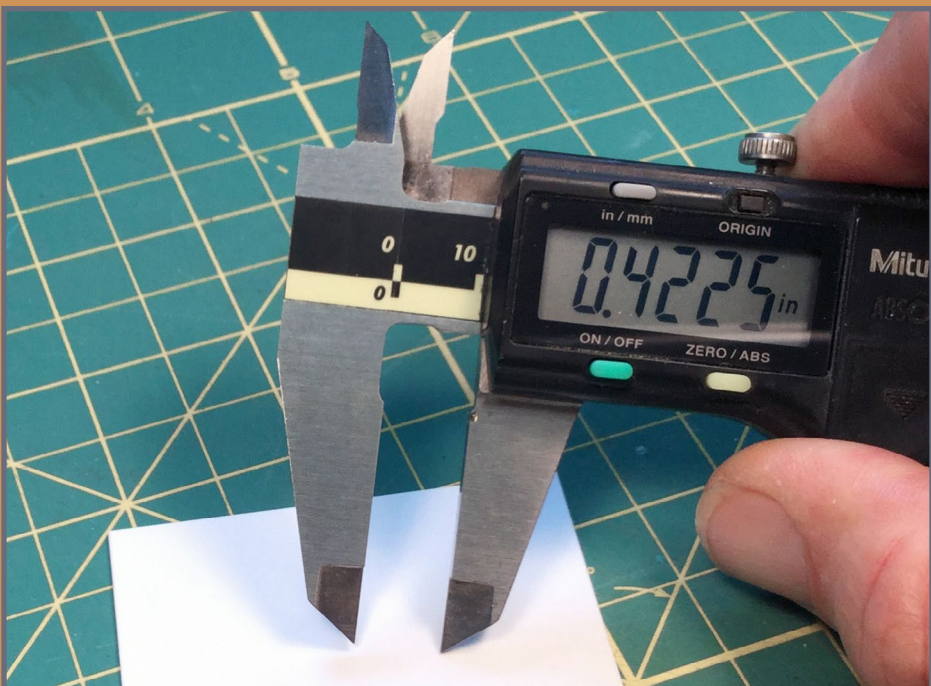

Model Railroad Hobbyist | April 2020

**JACK BURGESS** looks at using digital calipers for modeling ...

**WHEN I BEGAN WRITING ARTICLES FOR MODEL** railroading magazines in 1975, I spent all of the payments I received on tools. That should not be surprising to faithful “Tool Shed” readers.



**RATE THIS ARTICLE**

The first “expensive” tool I purchased was a Sears Craftsman dial vernier caliper. Unlike today’s digital calipers, they didn’t need batteries. I still occasionally use mine when I need to measure something longer/wider than my 4” digital caliper. Dial vernier calipers have been displaced by digital calipers, and are no longer widely available [1].

However, being a traditionalist, I resisted for years and continued to be happy with my original dial vernier caliper. However, the cost of digital calipers eventually became significantly cheaper (most likely when models made in China arrived).

When Harbor Freight began selling digital calipers [2] for \$20, I gave up on my old ways and purchased a 4” model and later a 6” model. I eventually purchased a second 6” model when the first one failed.

As I recall, they were accurate, compared to my old dial vernier caliper and initially worked fine. But one of the 6” models

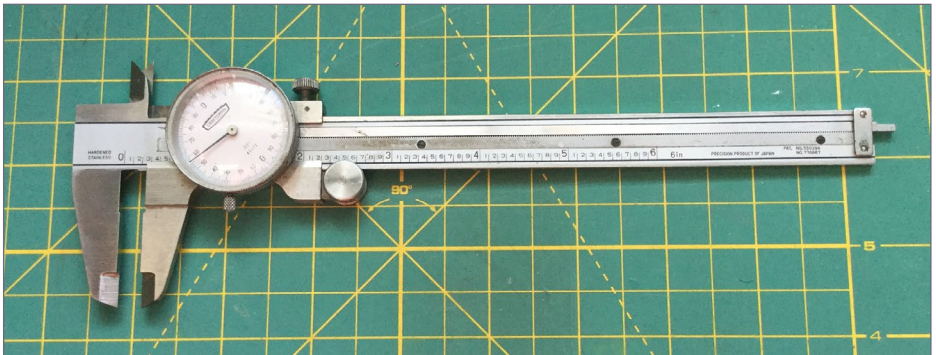

**1. My original 6” Sears Craftsman dial Vernier caliper.**



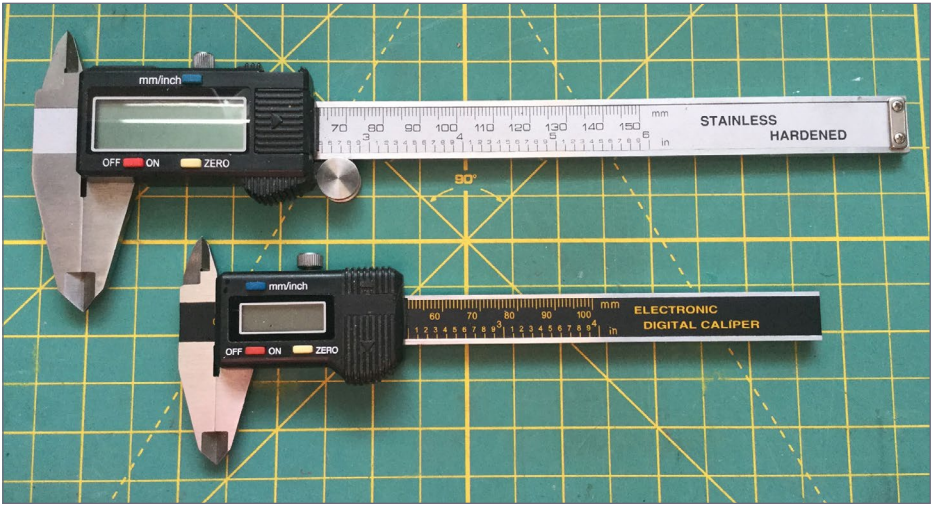

2. Two of the three Harbor Freight digital calipers I originally purchased as my move to digital calipers. These inexpensive calipers have served their purpose, but after upgrading to my Mitutoyo caliper, these “cheapies” are now obsolete for me and I am discarding them.

seemed to “eat” batteries if I forgot to turn it off after taking a measurement. The other one eventually wouldn’t turn off.

Getting frustrated with these continuous problems, I emailed a friend, who is the owner of a company that produces injected plastic freight cars, and asked for his recommendation for a *good* digital caliper. He suggested a Mitutoyo Absolute Digimatic 4” Model 500-170-30 digital caliper.

At around \$150 on Amazon, it is not an inexpensive alternative to Harbor Freight offerings. But it measures to 0.0005” accuracy (higher than Harbor Freight) and you don’t need to be concerned about battery life. This caliper [3] uses very little battery power, so the battery lasts a very long time.

If you enjoy the feel and accuracy of precision tools, consider such a quality tool. For some reason the same caliper with a 6" range is \$5 cheaper, although I don't think that was the case when I purchased mine many years ago.

## Uses of a digital caliper

When I purchased that early Craftsman dial vernier caliper, the first thing I did was to measure the drill bits in my circular 60-80 drill bit holder. Not unexpectedly, many of those drill bits were in the wrong place in the holder, the result of years of breaking drill bits and not putting others back in the proper spot.

In hindsight, a 61-80 drill gauge would have been a much better way of addressing that problem, and I encourage modelers to purchase one of these metal drill gauges [4] for about \$15.00. Using a



3. My Mitutoyo digital caliper. You can see that the caliper reads to the nearest 0.0005 inch. The lower jaws are used to measure outside dimensions while the jaws at the top are used to make inside measurements. The gray button above the LCD display changes the display from metric to inches.

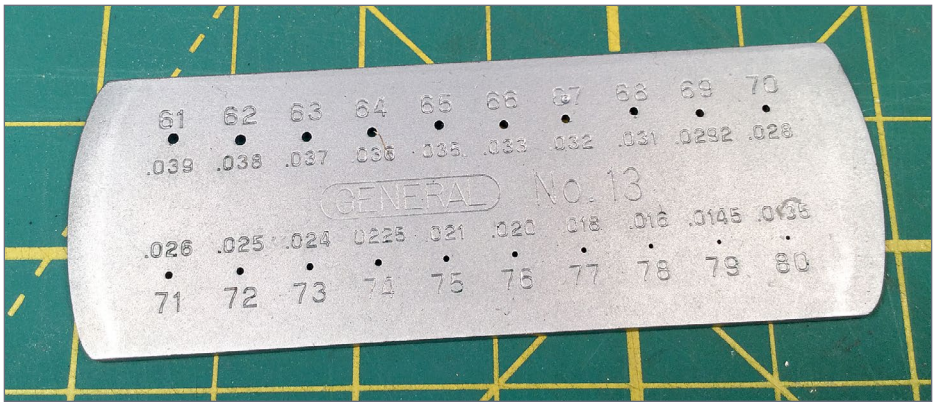

**4. This drill gauge made by General is what I use to check 61 to 80 drill bits.**

digital caliper to measure the shaft of a drill bit is not an accurate way to determine the drill bit size.

I find myself using my digital calipers all of the time. Resin freight car kits typically include grab irons and the instructions suggest drilling the holes based on a drill bit size such as a No. 78. A No. 78 drill bit results in a hole which is 0.016" in diameter. But what is the thickness of those supplied grab irons?

Those from Westerfield are made from 0.012" wire. If you drill the holes for those grab irons with a No. 78 drill, the holes will be over-size for the grab irons which can easily result in grab irons which are not parallel to each other.

I therefore always ignore suggested drill bit sizes listed in the resin kit instructions and measure the wire specified for a particular application and pick the appropriate drill bit. But you would not know about this discrepancy without a good digital caliper.

Assume that you are scratchbuilding a small structure using Grandt Line or Tichy windows and doors. You can hold one of

these castings against what will be the side of your building and try to trace around it so that you can carve out the opening, or you can use a better way.

Both Grandt Line and Tichy list the size of openings needed for their windows and doors on their websites. Look up the “Fits in” size (Grant Line), or under “More Information” (Tichy), and set your caliper to that dimension.

Next, lock the caliper by lightly tightening the lock screw on top of the caliper and use the jaws on the caliper to transfer that width and height to each window and door onto the structure walls [5 and 6]. Cut the opening to match your marks, and the castings will fit perfectly.

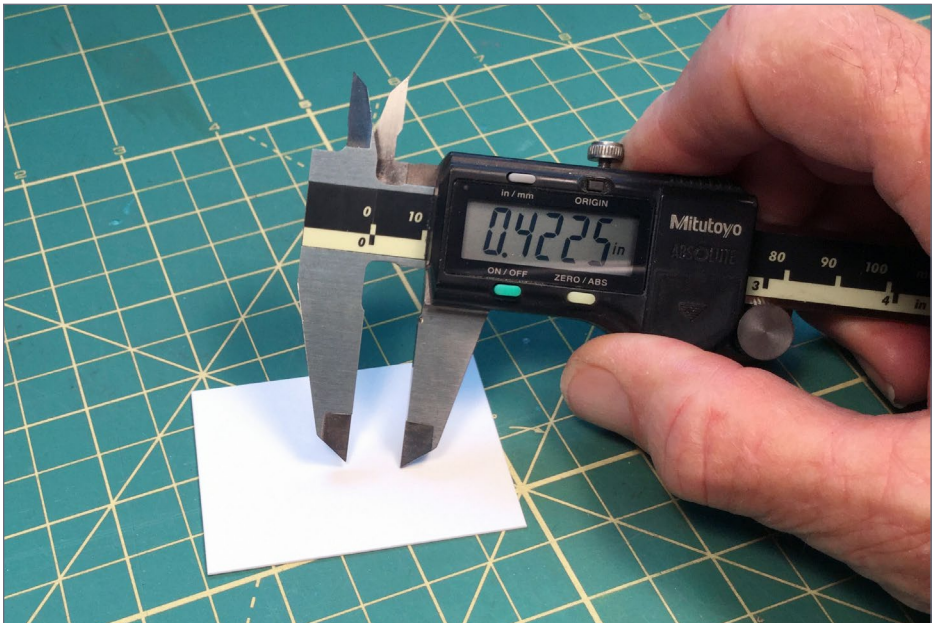

5. With the lock screw on the caliper set, push one jaw into the styrene to make a small mark.

You can also use the caliper to scribe styrene for cutting. Say you need a piece of styrene 45 inches wide which is 0.5172" in HO scale. Dial 0.5170" into your calipers (which is as close to 0.5172 as you can set the caliper) and lock them. You can then easily scribe a cut line on the styrene [7 and 8].

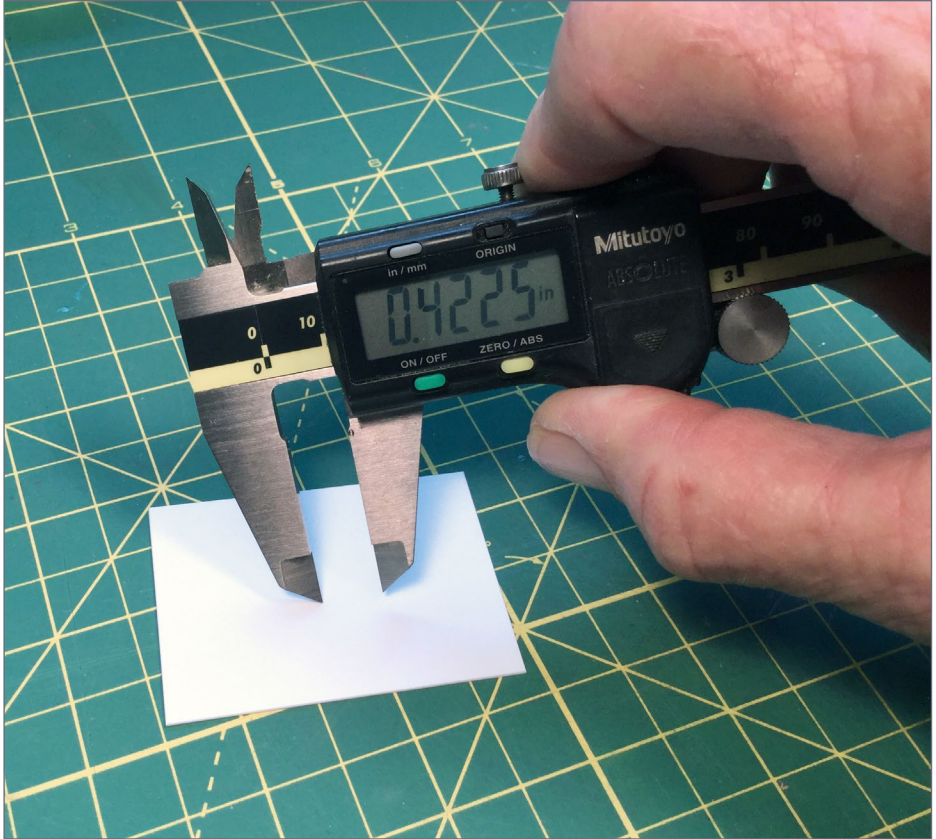

6. Rotate the other jaw onto the styrene to make a second mark. Then draw a circle around each mark with a pencil so that they don't get lost. If you use a square or straightedge to scribe a line through the marks, you will feel the knife "drop" into the mark when the straightedge is aligned with the mark.

## Measurement calculations

Using calipers in your modeling can result in more accurate modeling in two ways. First, the materials that you use to duplicate prototype parts, whether the diameter of the main brake pipes on a freight car or the trim material on a building, will be more accurate. Using calipers to lay out a building or scratchbuilt a freight car can be more accurate than using a scale ruler.

But in many cases we need to convert real, prototype dimensions to scale dimensions, and the other way around. I know that this might sound a lot like high school math but it is easy.

For example, I want to add some uncoupling levers to a freight car I'm building. I have an actual uncoupling lever from a Yosemite

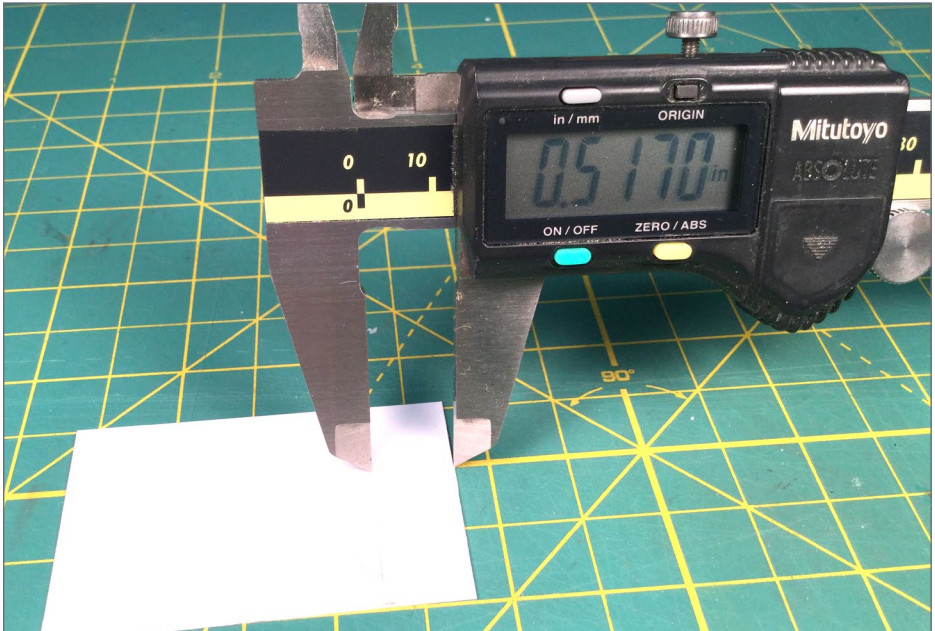

7. Scribing a piece of styrene using the caliper.

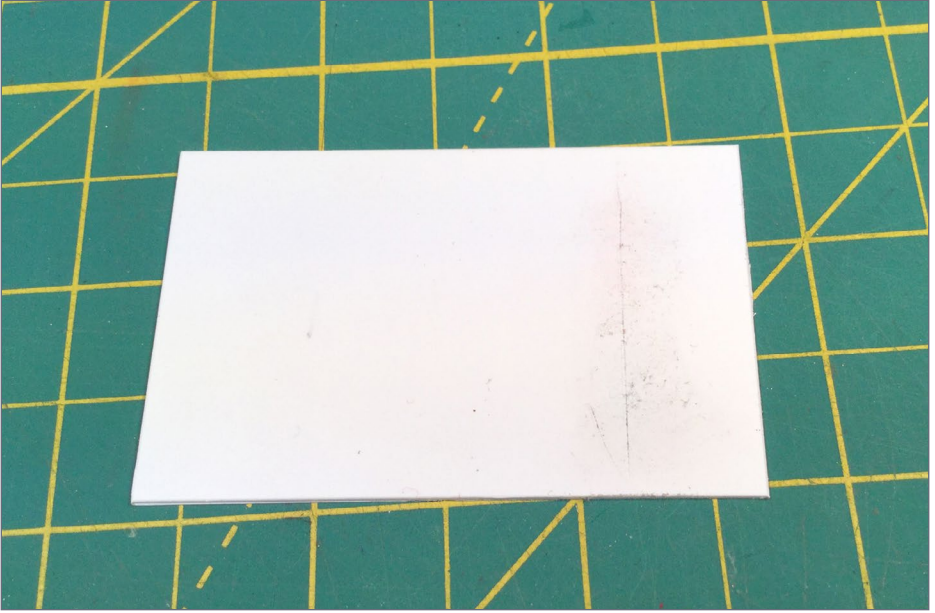

**8. You can easily see the scribe line if you rub your finger in some dust and draw it across the scribe line.**

Valley Railroad stock car, and it was fabricated from 1" round bar stock. What size brass wire do I use to model 1" in HO scale?

There are two basic rules when converting dimensions from real measurements to scale dimensions. First, everything needs to be converted to inches since we will be selecting materials in inches. That 1" round bar stock is already in inches. If a measurement is in feet and inches, multiply the feet by 12 and add that to the number of inches.

Now back to the first question, what size wire do we need to replicate the uncoupling lever in HO or another scale? Simply divide the prototype dimension in inches by your scale factor. You probably already know your scale factor but if not they are: O scale is 48, S scale is 64, HO scale is 87.1 (I just use 87), and N scale is 160.

The uncoupling lever is 1" in diameter. Assuming that you are modeling in HO scale, divide 1 by 87 and you get 0.0115". You therefore need to use 0.012" brass wire to create scale uncoupling levers.

There are some other things you can also do with digital calipers. If you are building a flat car and need to find the center of the car so that you can accurately position the bolsters. To do that, measure the width of the flat car in inches and divide the result by two. That would be the center line of the car.

Dial that result into your caliper and lock the caliper so that it won't move. Then scribe a line onto the bottom of the frame of the car from one side. Check your effort by tracing the same line from the opposite side of the car. That will be the center line for the bolsters and the trucks.

When you slide the caliper open, a depth rod slides out of the other end. Need to know the depth of a hole? Position the caliper above the hole and open the caliper so that the depth rod bottoms out in the hole. That will give you the depth of the hole.

I use my calipers on just about everything that I build. I have found them indispensable.

*Disclaimer - I love good tools and don't hesitate to invest in them.*

You can find a shopping list for this article here:

[mrhmag.com/magazine/mrh2020-04/digital-calipers](http://mrhmag.com/magazine/mrh2020-04/digital-calipers)

**Did you see this article**  
in **MRH** **RUNNING** **EXTRA** ?



**More on computer  
virtual model  
railroading**

**Get the April eBook now** ← click here







# Introducing THE LUMBER STORE

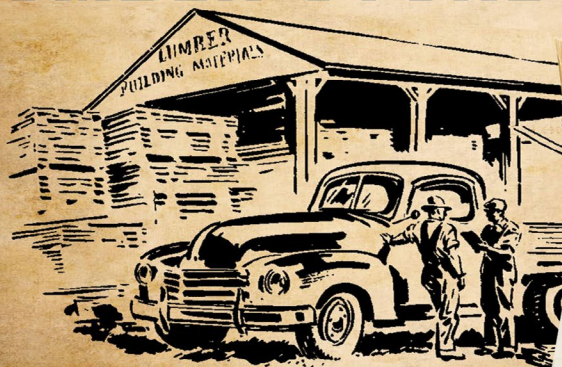

## ROTATING STORAGE RACK

On its own, or fully loaded with Mt. Albert Scale Lumber!

[handlaidtrack.com](http://handlaidtrack.com)

1-888-252-3895

## Take the MRH 2020 Reader Survey ...

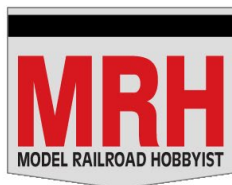

... and get a chance  
to win a 7" Kindle  
Fire tablet!  
(5 tablets will be awarded)

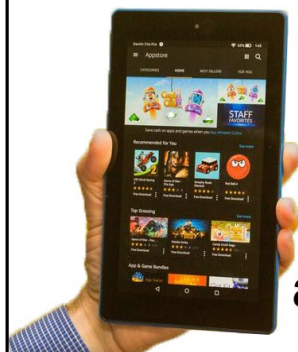

**TAKE THE SURVEY >>**



*It's all about trains*



*All things train related,  
whenever, wherever.*

**TRY  
24TRAINS.TV  
2 WEEKS  
FOR FREE**



**[WWW.24TRAINS.TV](http://WWW.24TRAINS.TV)**



**On 24TRAINS.TV you can find:**

videos | travel reports | magazines | vlogs  
model railways | workshops | documentaires | holidays

[MRHMAG.COM](http://MRHMAG.COM)

[INDEX](#)

[TABLE OF CONTENTS](#)

# SAVVY MODELER *Online*



Model Railroad Hobbyist | April 2020



RATE THIS ARTICLE



## Coloring model rocks to look more like real rocks

Last month, YouTube modeler ***BNSFUPRailroader*** showed how to carve realistic rock formations in plaster. Here in part 2, he shows how he paints his carved rocks to look like real rocks. He goes through the process, step-by-step, showing the paint colors and the techniques he uses. You can replicate his methods and also get some great looking rocks on your layout! ■



▶ GREAT MODELER VIDEOS ON THE WORLD WIDE WEB

# You're the kid.



## Welcome to the candy store.

**July 17-19, 2020**

**America's Center  
Convention Complex  
St. Louis, Missouri**

For more information,  
click here to visit:

**NationalTrainShow.org**

**CLICK HERE  
FOR ALL THE  
DETAILS!**

[www.nationaltrainshow.org](http://www.nationaltrainshow.org)

Sponsored by



We make it more fun!

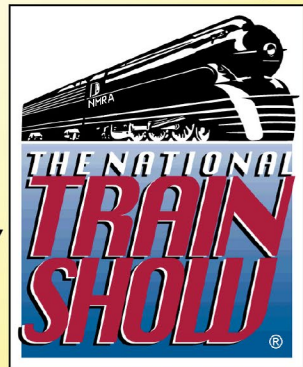

# APRIL NEWS

column



Model Railroad Hobbyist | April 2020

**RICHARD BALE** and  
**JEFF SHULTZ** report the  
latest hobby industry news



## NEW CLUB CARS



Model by Bob Chaparro

The **NMRA-Pacific Southwest Region** has made its 2020 convention car available online. Produced for PSR by Accurail, the HO scale kit is based on class B-50-13

boxcars built by Standard Steel Car Co. in 1924 for Southern Pacific and its subsidiaries. The single-sheathed prototypes were built with wood ends, however, many were rebuilt with corrugated steel ends in the early 1930s. PE still owned 177 of these cars in 1950. A year later they became part of the SP fleet.

The PSR convention car is based on Pacific Electric No. 2720. The kit comes with appropriate trucks, Accumate knuckle couplers, decals

► THE LATEST MODEL RAILROAD PRODUCTS, NEWS & EVENTS

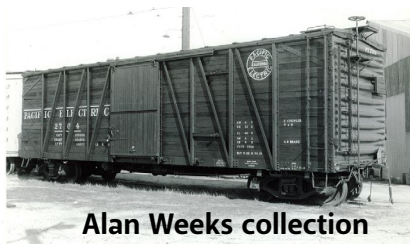

Alan Weeks collection

for renumbering, and a separate add-on convention logo. To order visit [www.psrconvention.org/VanNuysLocal2020](http://www.psrconvention.org/VanNuysLocal2020) and go to the Company Store.



## Worcester Model

**Railroaders Inc.**, is offering an Evans 52-foot steel gondola

decorated for Warwick Railway, a subsidiary of the Providence and Worcester. The ready-to-run HO scale model was produced for the Massachusetts-based club by Atlas. For additional information visit [wmrr.org/club-cars](http://wmrr.org/club-cars).

## NEW PRODUCTS FOR ALL SCALES

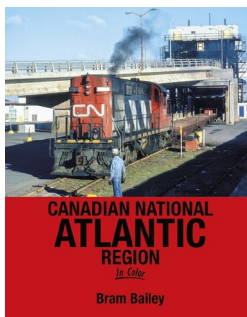
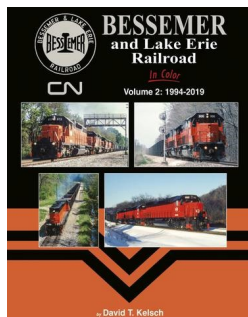

New publications coming next month from **Morning Sun Books** include Volume 2 of *Bessemer & Lake Erie Railroad*, in which author David Kelsch presents a color portfolio of operations and equipment from 1994 to 2019. Bram Bailey's study

of the *Canadian National Atlantic Region* is scheduled for release in June. Photo highlights include CN's RSC-14 program where 38 RS-18 locomotives were modified with six-wheel trucks for operation on the light rail branch lines typical of those in the Canadian Maritimes. CN operations are documented in the provinces of New

Brunswick, Prince Edward Island, and Nova Scotia. For additional information contact a dealer or visit [morningsunbooks.com](http://morningsunbooks.com).

.....

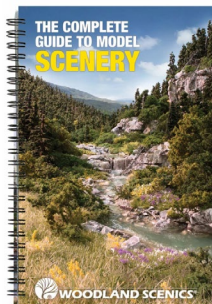

**Woodland Scenics** has released a full-color book titled *The Complete Guide to Model Scenery*. The new publication combines Woodland Scenics original *Scenery Manual* and *SubTerrain Manual* into one expanded book. The book offers tips, techniques, and step-by-step information on creating model scenery. The wire-bound 200-page publication will lie flat on a work bench. For additional information contact a dealer or visit [woodlandscenics.com](http://woodlandscenics.com).

.....

## HO SCALE PRODUCT NEWS



New HO scale rolling stock kits from **Accurail** include this Baltimore & Ohio 40' PS-1 steel boxcar. The model represents a prototype Pullman-Standard delivered to the B&O in September 1963.



Accurail's HO scale version of this Denver & Rio Grande Western 36-foot Fowler wood boxcar is based on a car built in 1916 and rebuilt in 1929. The unique herald promotes the D&RGW's scenic Royal Gorge Route.



The prototype of this Canadian National 70-ton triple-bay open hopper with offset sides is based on a car built in

March 1959. All Accurail kits come with appropriate trucks and Accumate knuckle couplers. For additional information contact a dealer or visit [accurail.com](http://accurail.com).

.....



R. Bale

## EMD SD60M DIESEL UNITS

EMD unveiled the first SD60 locomotive in 1984. The four demonstrators were equipped with 3,800hp 16-cylinder 710 series turbocharged prime movers. Five years later, EMD upgraded the SD60 with a Safety cab. The wide nose cab featured a distinctive 3-piece windshield that earned the locomotives the nickname Tri-Clops. Union Pacific was the first road to order the new SD60M locomotives followed by Burlington Northern and SOO Line. BN's SD60M locomotives went on to the merged BNSF while the SOO units went to Canadian Pacific. Later, some of the BNSF units were leased to Norfolk Southern and CEFX.

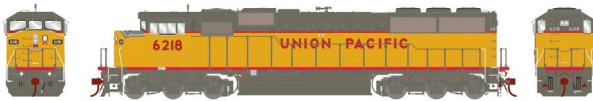

**Athearn** plans to release an HO scale version of EMD's

SD60M next February. Heading the list of road names for the Genesis 2.0 model is a Union Pacific unit that features the original, as-delivered details including rounded front number board housings, operating front ditch lights, and a large electrical cabinet behind the cab.

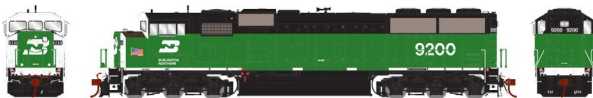

Burlington Northern versions of Athearn's SD60M will have a

deck mounted strobe light, a small window in the nose door, a



small access door on the left of the cab, and a long panel with a door for access to the dynamic brakes.

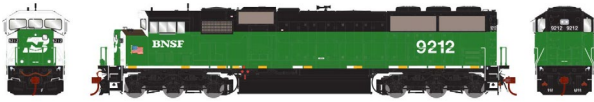

In addition to pre-merger details, BNSF units will have working ditch lights, a blower housing kick plate on the handrail, and a replacement horn.



Norfolk Southern modified its ex-BN SD60M tri-clops with the addition of a large electrical cabinet behind the cab.



Features unique to the Canadian Pacific (ex-SOO) SD60M tri-clops diesels will include a small access door on the left side of the cab, a large window in the nose door, working ditch lights, and a winterization hatch.



Norfolk Southern modified its ex-BN SD60M tri-clops with

front ditch lights and a large electrical cabinet behind the cab. Features on all versions of the Athearn Genesis 2.0 SD60M include etched see-through walkway steps, illuminated number boards and ground lights, uncoupling levers, rubber MU and trainline hoses, cab interior details, walkway tread, wire grab irons, Celcon handrails, windshield wipers, lift rings, a detailed fuel tank, sander lines, and LED lighting.

The Genesis all-wheel drivetrain includes a 5-pole skew wound motor, machined flywheels, and all-wheel electrical pickup. DCC models with sound will have dual sugar cube speakers. DC models

are DCC-ready with a 21-pin connector for installation of an after-market decoder.



Also scheduled for release from Athearn next February is a Genesis 33,900 gallon LPG tank

car. Phase variations include early, flat panel, and late body designs. Features include wire railings, uncoupling bars, brake and trainline hoses, printed placards, separately applied walkway and manway platforms, and full brake rigging detail.



The Genesis HO scale model comes with 100-ton trucks with machined wheelsets and rotating bearing caps. Road names will be TILX, UTLX, SRIX, UPEX, and PROX.



R. Bale

## AUTO-MAX VEHICLE CARRIER

Gunderson began production of the 140-foot long articulated Auto-Max car in 1999. This unique car carrier can handle 22 SUVs on three levels. Given its excessive length and 20-foot height, the Auto-Max pushes the operational and clearance limits of the railroad industry, particularly in the northeast region of the nation.



Athearn has included Auto-Max auto-carriers in its February

2021 production schedule. The HO scale models will have a flexible diaphragm and full articulation. A minimum track radius of 22" is recommended for reliable operation.



Separately applied details will include ladders, brake rigging, stirrup steps, and brake equipment. The articulated car rides on three 70-ton roller-bearing trucks with 33" machined metal wheelsets.



Three numbers each will be available for cars decorated for

AOK, BNSF, CSXT, FXE, KCS, and CMO.



Athearn reports it will include Freightliner COE (cab-over-engine) trucks and matching 28-foot trailers in its February 2021 production schedule. The

trucks and trailers will be available decorated for United Parcel Service, XPO Logistics, Motor Cargo, Transcon, YRC, Estes, and Old Dominion.



The trailers will also be available separately in two-packs with landing gear and different fleet numbers. Athearn's Freightliner COE trucks, which represent

equipment introduced in the mid-1970s, will also be available individually. Features include clear window glazing, interior details with a separately applied steering wheel, and rubber tires. The Freightliner trucks will be decorated in the carrier names listed above as well as in purple, teal, and green without any lettering.



**Roundhouse brand** models coming from Athearn in February 2021 include a group of 40' steel refrigerator cars.



Decorating schemes include SRIX/Swift, WFEX/Northern Pacific, American Refrigerator Transit, Pure Carbonic Co., Illinois Central, St. Louis

Refrigerator Car Co., and three PFE schemes including an aluminum car. For additional information on Athearn and Roundhouse products contact a dealer or visit [athearn.com](http://athearn.com).



**Bachmann** is selling HO scale models of steel bay-window cabooses. The Silver Series ready-to-run models come with knuckle couplers and appropriate trucks

with metal wheelsets. Two styles of bay window are available.



Road names include Baltimore & Ohio, Erie, Nickel Plate Road, New York Central, Santa Fe, and Union Pacific.



For additional information contact your favorite dealer.



**Berkshire Valley Models** has expanded its selection of kits for horse-drawn vehicles with the addition of a farm wagon,



an ore wagon, and a Heinz delivery wagon. Harnessed horses are available singly and as a team. The wagons are composed of laser-cut wood and white metal castings. The horses are of white metal. The assembly instructions include photos and suggestions for painting. For additional information visit [www.berkshirevalleymodels.com](http://www.berkshirevalleymodels.com).

.....



**Bowser** has announced undecorated HO scale ballast car kits from their English's Model Railroad division. The kits include a modified 70-ton

2-bay hopper car body. The hopper body has been milled to accept the 3D-printed chutes, and additional parts include roofs, brake details, free-rolling trucks with metal wheels, and knuckle-spring couplers. Two versions of the kit, with an "open V" hopper body or a "closed side" hopper body, are available. Data only and decorated cars are expected to follow soon. For more information visit [www.bowser-trains.com](http://www.bowser-trains.com).

.....



**Broadway Limited** expects to

deliver the long-awaited streamlined Pennsylvania 4-6-2 class K4 steam locomotives this spring. In 1936, PRR locomotive No. 3768 was clad in a streamlined shroud designed by famed industrial designer Raymond Loewy.



A matching tender rode on unique six-

wheel trucks. The PRR's advertising department made the most of the slick looking engine, however the streamline panels hid most of the locomotive's working parts and impeded maintenance. Eventually most of the shrouding that covered the wheels, rods, and cylinders was removed.



Broadway Limited will offer a 1936 version of the streamlined K4 in several paint schemes including bronze and DGLE

(dark green locomotive enamel), and with both low and high mounted Keystones. Unlettered models in both bronze and DGLE will also be available. The HO scale model will come with Paragon3 Sound & Operation System. For additional details contact a dealer or visit [broadway-limited.com](http://broadway-limited.com).



**InterMountain Railway** has scheduled another production run of ACF twin-bay covered hoppers. Advance reservations for the HO scale model are due by April 30, 2020.



Eight road names will be available including Norfolk & Western, Winchester Western, Chicago & North Western, Burlington Northern, CSX, Union Pacific, BNSF, CEMX.

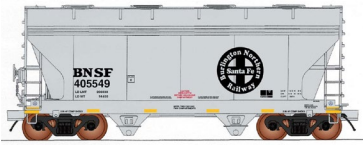

The ready-to-run model comes with knuckle couplers and appropriate trucks with machined metal wheelsets. For additional information

contact a dealer or visit [intermountain-railway.com](http://intermountain-railway.com).

.....



R. Bale

## PS-1 BOXCARS

One of the most successful designs of plain boxcars was the PS-1, with Pullman Standard producing more than 100,000 PS-1 boxcars between 1947 and 1963. By 1957 more than 78 railroads had purchased PS-1s. Although commonly referred to as 40' or 50' cars, the interior lengths were 40'-6", and 50'-6" respectively. The sides of most PS-1s were assembled of butt-welded steel panels riveted to the door frames and corner posts. Between 1948 and 1954 Pullman Standard produced a number of 40' PS-1s with 10-panel riveted sides. Customers could specify side door openings of 6, 7, 8, and 9 feet on the 40' cars, and 8, 9 or 15 feet on the 50' cars. Double doors could also be specified. Customers had a choice of Pullman Standard, Youngstown, or Superior sliding side doors.

The corrugated steel ends were of Pullman Standard design stamped in two sections riveted together. The assembled end was riveted to the sides and at the roof. PS-1s built after 1949 had a signature of six small rectangles at the top of the ends. Polling pockets and the type of end sills were optional. The copper bearing galvanized roof was composed of riveted panels of Pullman-Standard design. The cars came with Apex or U.S. Gypsum steel brake platforms and running boards. The brand of geared hand brakes varied with Miner, Ajax model IP80, and Equipco type 4000 being among the most common.



Coming soon from **Kadee** is a 40' PS-1 boxcar decorated for Chesapeake & Ohio. The HO scale ready-to-run model replicates a prototype built in 1952 with 8' Youngstown sliding doors. Kadee models come with Kadee metal couplers and self-centering trucks. For more information contact a dealer or visit [kadee.com](http://kadee.com).

.....



**Oxford Diecast** has released two new 1:87 scale vehicle models including this 1957 Dodge Sweptside D100 pickup truck. The model is tricked out with a two-tone paint job and wide whitewall tires.



Also new from Oxford Diecast is a 1946 DeSoto Suburban with a wood roof rack. For additional information contact a dealer or visit [walthers.com](http://walthers.com).

.....



**Ring Engineering** has introduced a new Power Backup Module (PBM-2) that will temporarily supply power to a locomotive module whenever the normal flow of power is interrupted by dirty track or other causes. The PBM-2 measures 1.27 x 0.66 x 0.32" and can be added to any HO scale locomotive.

Unlike most backup systems that are essentially large capacitors that discharge voltage



rapidly, Ring's PBM-2 is an active device with an onboard microcontroller and other electronics that releases a fixed voltage output enabling locomotives to perform better and lights to stay a constant brightness. For additional information including a FAQ guide visit [ringengineering.com](http://ringengineering.com).

.....



R. Bale

## FAIRBANKS MORSE H-16-44

Fairbanks Morse introduced the 1600hp 8-cylinder H-16-44 road switcher in 1950. More than 350 of the locomotives were completed when production ended in 1963. Midway through the production period, the H-16-44 was updated with raised walkways and changes in the hood to simplify production. The general appearance was similar to F-M's larger Trainmaster, but with four axles rather than six. Internal upgrades centered on replacing the Westinghouse electrical system with a more robust control system supplied by General Electric. H-16-44 units ordered by Canadian Pacific and Canadian National were built by F-M subsidiary Canadian Locomotive Company. The final H-16-44 was built for the Ferrocarril de Chihuahua al Pacifico Railroad in 1963. This was the last locomotive produced by Fairbanks Morse.

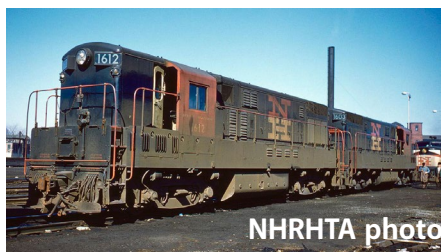

**Rapido Trains** has announced plans to produce an accurate and fully detailed HO scale version of a Fairbanks Morse H-16-44 road switcher. The HO scale model is based on a Phase III prototype the Rapido team

located and measured in Alberta, Canada.

Features will include accurate hood doors, separate grab irons and handrails, full underbody piping and conduits, illuminated number boards, headlights and green and white class lights. Variables depending on the prototype road being modeled include different fuel tanks, steam generators, dynamic or non-dynamic bodies, and Dofasco or AAR trucks. The drive system will be the same as employed on Rapido's FA-2 locomotive.

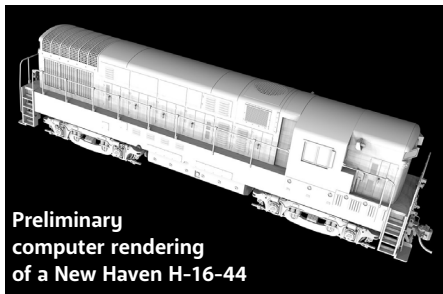

Preliminary computer rendering of a New Haven H-16-44

Rapido reports that while it is not abandoning LokSound, it is currently working with TCS to develop a new Rapido-TCS decoder that is fully compatible with its ESU LokSound decoders. The Rapido-TCS decoder will not be a Wow Sound decoder,

thought it will have many of the popular Wow Sound features as options. Models equipped with Rapido-TCS decoders will incorporate a Keep Alive function.

Although specifics on the H-16-44 decoder are pending, Rapido will announce full details before the order deadline.



Rapido has scheduled another production run of 53' high-cube containers with delivery planned for later this year.

Two-packs with new fleet numbers will be available for CN (We Deliver), CN (Intermodal), CP (gray), CP (red), JB Hunt, and Schneider.

★ ★ ★ ★ ★  
**RATE THIS ARTICLE**



New carrier names in this production run include Armour Transportation, Clarke (Transforce), Western Canada Express, Maritime-Ontario, and undecorated. For additional information contact a dealer or visit [rapidotrains.com](http://rapidotrains.com).

.....



**Resin Car Works** has a new kit for a Milwaukee Road 48'-6" composite gondola. The HO scale craftsman kit replicates the more than 1000 cars built in 1937 in Milwaukee Road shops. The cars featured welded construction, stamped steel ends, and drop bottom doors. Following the period represented by this model, the cars were rebuilt with steel sides and solid steel floors.

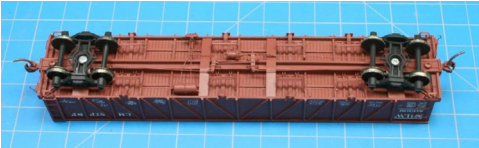

The kit features a one-piece cast resin body, Tichy ladders and brake hardware, Precision Design decals, and Tahoe ACF 70-ton A-3 truck side frames. Couplers and wheelsets are not included. For additional information, including ordering instructions, visit [resincar-works.com](http://resincar-works.com).

.....



**ScaleTrains.Com** is working on a new run of the HO scale version of the GE Dash diesel locomotive. Both Operator Series and Rivet Counter versions of the ready-to-run model will be offered. Road names for the Rivet Counter Dash-9s will include Norfolk Southern's Thoroughbred scheme with D9-40CW stenciling.



feature two different paint schemes on one locomotive.

A Southern Pacific Dash-9 will be available along with two of BNSF's unique Heritage I/Heritage II Frankenlocos that



Some of the BNSF locomotives from this production run will have exhaust housing covers.

Rivet Counter features include wire grab irons and lift rings, windshield wipers, snowplows, horns, uncoupling levers, trainline hoses with silver glad hands, sand hatch covers, directional LED headlights, LED lighted number boards, treadplate detail, separate plumbing and traction motor cables, see-through dynamic brake intakes with resistor grid detail, sliding cab windows, detailed cab interior with standard AAR control stand, and metal semi-scale E Type knuckle couplers.

Rivet Counter DCC and sound equipped models will have ESU LokSound 5 DCC & sound decoder, dual cube-type speakers, and an ESU PowerPack with two supercapacitors. DC locomotives are DCC and sound-ready with a 21-pin connector for an aftermarket decoder.



Road names for the economy priced Operator series Dash 9-44CW will be BC Rail, BNSF, and a GE Demo. Operator series features include LED lighted and printed number boards, operating LED ditch lights and headlights, see-through steps, nub walkway tread, finely-molded grilles, cab interior, and numerous factory applied details including snowplow, windowed nose door, sunshades, air tanks, exhaust stack, horn, and brake wheels.

Road names for the economy priced Operator series Dash 9-44CW will be BC Rail, BNSF,



Operator series DC/DCC-ready models will be available as well as DCC units with factory installed sound. A detail kit

with grab irons, uncoupling levers, MU cables, and trainline hoses the modeler can install in predrilled holes will be available as a separate purchase.

Both Rivet Counter and Operator series locomotives utilize the same power chassis that features all-wheel drive and electrical pickup, a 5-pole skew wound motor, and dual flywheels. For additional information visit [scaletrains.com](http://scaletrains.com).

.....



**Tangent Scale Models** has released another group of HO scale General American 4180 cu.ft. Airslide covered hoppers. Variable

details that represent GA production changes from 1965 thru 1980 include different roofs, running boards, body side post profiles, high or low brake arrangements on the B end, different ladder and grab iron arrangements, and options in the application of crossover platforms and handrails. Additional details include see-through etched-metal running boards, wire uncoupling bars and grab irons, separate air hoses, and Kadee couplers. This production run has been upgraded with Tangent's new 100-ton Barber S-2 roller-bearing trucks that feature rotating ends caps, separate brake beam detail, and machined 36" wheelsets.

Decorating schemes include a Boston & Maine car decorated with the Prince Spaghetti Day slogan. The unique car features 1977-era details.

This Chicago Burlington & Quincy model represents a group of 50 4180 Airslides with 1966-era details including high-mounted brake



appliances and Apex metal running boards. Four road numbers are available.

Two numbers are available for this Chicago & North Western 4180 that represents a 1967-built car repainted in CNW shops in 1983.

GA delivered the prototype of this car to Great Northern in March, 1968. The car features low brake details on the B-end, and an Apex running board.

This HO scale ROCK 4180 from Tangent is based on a group of 25 prototypes GA built in 1975. Correct phase details on the model include low mounted

hand brake, a later body with wide side posts, and an Apex running board.

Additional decorating schemes available on this run include a Louisville & Nashville car from 1971, and an ex-ROCK car patched for NAHX-Great Western Sugar. Undecorated options for the 4180 include three different phases in primer gray and undecorated kits. For additional information visit [tangentscalemodels.com](http://tangentscalemodels.com).

**Tichy Train Group** has released several new items including (left to right) chain rollers and sheaves, wrecking spreaders and hooks, and hopper door operators. Also new are a variety of signs, stove pipes, and double-sheathed wood reefer ends.



For a look at all the new items visit [www.tichytraingroup.com/WhatsNew.aspx](http://www.tichytraingroup.com/WhatsNew.aspx).

.....

This report on the **Walthers** Milwaukee Road Twin Cities Hiawatha name-train will demonstrate to readers why we discuss products a year or more in advance of their scheduled availability. Individual cars from this project are just beginning to arrive, but most are already sold out. All is not lost, however, since some hobby dealers who placed advance orders may have some models still available.

Walthers production run of the Twin Cities Hiawatha includes cars decorated in orange and maroon as well as in the later UP yellow and gray paint scheme. Details on all of the eight HO scale cars include tinted windows and factory installed grab irons. In addition to printed names and/or numbers, Walthers will include decals with a full set of names and numbers with each model.



The first car released was this 85' 52-seat coach which arrived in March.



A 63' Railway Post Office car (above) and an 85' 26-seat tap lounge car (below) are scheduled

to arrive next month.



A June date is planned for the release of a 75' express car (left).



Milwaukee Road's Pullman-built 85' skirted Super Dome (below) will arrive in July or August.



August or early September will see the arrival of this 85' 48-seat diner (left).



It will be followed about 30 days later by an 85' 30-seat parlor car (below).



The eight-car train set will be completed in October with the release of

Milwaukee Road's distinctive 85' Skytop lounge-observation car.



The orange and maroon cars with black roofs are typical of 1952-1956

equipment in service until repaints began in 1955. Notable details include black trucks, folded steps, straight side sills, and original ends without lift rings. The yellow and gray cars match Union Pacific equipment after the Milwaukee Road assumed operation of Chicago-Omaha trains in late 1955. The scheme became the standard on Milwaukee passenger equipment into the 1970s. The yellow and gray cars have silver trucks with disc brakes, notched side sills (except the Super Dome, which was not modified), fixed car steps, end lift rings, and updated diaphragms. A minimum 24" radius is recommended. For modelers operating on tighter curves, optional extended drawbars will be included with each car.





To lead the Twin Cities Hiawatha, Walthers will release EMD FP7A and F7B units appropriately decorated in both the orange and maroon (1950-1953) and the post-1955 yellow and gray livery. The diesel models will be available

for DC operation and with ESU LokSound 5 Sound and DCC.



For additional information contact a dealer or visit [walthers.com](http://walthers.com).

## N SCALE PRODUCT NEWS



car. Variations in body phases include early, flat panel, and late designs. Road names will be TILX, UTLX, SRIX, UPEX, and PROX.



Details include printed placards, wire safety rails and end hand-rails, photo-etched metal walkways and end platforms, 100-ton roller bearing trucks, and extensive underframe detail.

**Athearn** has scheduled a February 2021 release for an N scale 33,900 gallon LPG tank

car. Details include printed placards, wire safety rails and end hand-rails, photo-etched



R. Bale

## AUTO-MAX VEHICLE CARRIER

Gunderson began production of the 140-foot long articulated Auto-Max car in 1999. This unique car carrier can handle 22 SUVs on three levels. Given its excessive length and 20-foot height, the Auto-Max pushes the operational and clearance limits of the railroad industry, particularly in the northeast region of the nation.



Athearn has included Auto-Max auto carriers in its

February 2021 production schedule. A flexible diaphragm will provide full articulation for the N scale model. Separately applied details include ladders, brake rigging, and brake equipment. The articulated car rides on three 70-ton roller-bearing trucks with 33" machined metal wheelsets.



Three numbers each will be available for cars decorated for

AOK, BNSF, CSXT, FXE, KCS, and CMO.



Athearn will include N scale 28-foot trailers with landing gear in its February 2021 production schedule.

Carrier names will be United Parcel Service, XPO Logistics, Motor Cargo, Transcon, YRC, Estes, and Old Dominion. In some cases the



trailers will come with different decorating schemes for the same owner.



The trailers have rubber wheels and movable landing gear.



Completing Athearn's February 2021 production schedule of N scale models is an ACF 2970 cu. ft. twin-bay covered hopper car. The model will have round or

trough hatches depending on the prototype being modeled. Additional features include a photo-etched metal roof walk, separately applied wire grab irons, detailed outlets, separately applied brake wheel and brake equipment, body-mounted McHenry knuckle couplers, and appropriate trucks with machined metal wheelsets.



Road names will be Union Pacific, Burlington Northern, Burlington

Northern Santa Fe, CSX, Missouri-Kansas-Texas, Rock Island, and two Great Northern schemes. The N scale models will be available in a three-pack with unique road numbers. For additional information contact a dealer or visit [athearn.com](http://athearn.com).



**Broadway Limited** has released a group of Alco PA/PB locomotives. The

N scale models feature Paragon3 sound. The models are composed of an ABS cast plastic body with a heavy diecast chassis. Details include separately applied grab irons, rear diaphragms, and Micro-Trains compatible couplers. In addition to the Southern Pacific Daylight scheme seen here, A and A/B sets are available for Santa Fe and Denver & Rio Grande.



Additional road names for the N scale PAs include New Haven, New York Central, Pennsylvania Railroad, Union Pacific, and Cuyahoga Valley.



For additional information contact a dealer or visit [broadway-limited.com](http://broadway-limited.com).

.....



**KatoUSA** is quoting an August delivery date for a group of N scale GE ES44DC GEVO locomotives. Units decorated for Canadian National and CSX boxcar scheme have been added to the original list of road names that included Canadian Pacific, Union Pacific, and BNSF.



Features on the N scale model include directional headlights, preprinted illuminated number boards, functioning ditch lights, and Kato magnetic knuckle couplers.



Both DC and DCC versions of the N scale locomotive will be available. The models are also available on special order, through a dealer, with ESU LokSound. For additional information contact a dealer or visit [katousa.com](http://katousa.com).



Micro-Trains is selling N scale versions of a 78' single-window coach decorated for Great Northern and Canadian Pacific. The models represent standard heavyweight equipment built in the 1920s that continued to see service until replaced by lightweight cars in the 1950s and early 60s.



Enclosed tri-level auto racks, like this 89' Santa Fe car, began to appear in the late 1960s. The enclosed design effectively decreased vandalism and damage to new automobiles being transported from assembly plants to car dealers.



Micro-Trains has released this 50' Airslide twin-bay covered hopper car decorated for Archer Daniels Midland. The N scale model rides on 100-ton roller-bearing trucks.

Micro-Trains is selling N scale versions of a 78' single-window coach decorated for Great Northern and Canadian Pacific. The models represent standard heavyweight equipment built in the 1920s that continued to see service until replaced by lightweight cars in the 1950s and early 60s.



This 50' boxcar is fitted with two 8' sliding doors. One is a Youngstown corrugated door, the other is a six-panel Superior door.

The N scale model is based on a prototype built in 1957 for New York Central for auto parts service. In a later rebuild the running board was removed, the ladders shortened, and the car repainted for Conrail.



Micro-Trains has released this 39' single-dome tank car decorated for Deep Rock. Founded in 1913 by H.M. Byllesby, a Chicago investment banker, Deep

Rock grew in the 1920s and 30s with the purchase of several rivals. Contact a dealer for additional information.

## NEW DECALS, SIGNS AND FINISHING PRODUCTS

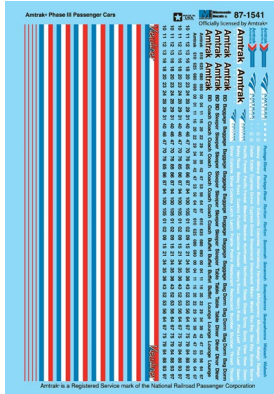
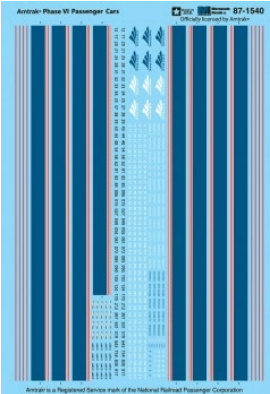

**Microscale** has released new HO and N scale water slide decals for Amtrak Phase III (introduced in 1976) and Phase VI (introduced in 2002) passenger cars. For additional information contact a dealer or visit [microscale.com](http://microscale.com).

**Switch Line Decals** is selling HO scale water slide decals for Rocky Mountain Railway locomotives and passenger cars, and for Great Canadian Rail Tours passenger equipment. For details visit [switchlinedecals.com](http://switchlinedecals.com).



**Prime Mover** has water-slide decals for Delaware, Lackawanna & Western maintenance of way equipment. The HO scale white lettering sheet covers all categories of DL&W MOW equipment including flangers, plows, side dump cars, bunk cars, troop sleepers, and tool cars. For additional information visit [primemover-decals.com](http://primemover-decals.com).

## DISCLAIMER .....

The opinions expressed in this column are those of the writer and do not necessarily reflect the opinion of *Model Railroad Hobbyist* or its sponsors. Every effort is made to provide our readers with accurate and responsible news and information, however, neither *Model Railroad Hobbyist* or the writer of this column can be held responsible for any inaccuracies or typographical errors that may inadvertently appear in this column.





## BRIEFLY NOTED AT PRESS TIME ...

Among the new models coming soon from **Accurail** is an HO kit for a 50' Southern Railway steel boxcar with welded sides and a single sliding door...

**Atlas's** 3rd quarter schedule includes a new N scale GP60 and new paint schemes for a 40' wood reefer and steel flat car. Both N and HO scale versions of a 64' Trinity reefer, 5077 cu. ft. boxcar, and two versions of steel cabooses, plus HO SD24 and SD26 diesels are all coming later this year. O scale modelers can look forward to new paint schemes on a 40' Airslide hopper and a Ford F-100 pickup...

**Morning Sun Books** has released *Trackside around Pueblo 1955-1970* in which author Jim Boyd presents the steam-to-diesel transition period on Colorado's famous "Joint Line" between Denver and Pueblo and the Fort Worth & Denver in Texas. Operations include the Santa Fe, Denver & Rio Grande Western, Colorado & Southern, FW&D, Rock Island, Missouri Pacific, and the Colorado & Wyoming railroads...

**Did you see this article**  
In **MRH** **RUNNING** **EXTRA** ?



**Storing your models more safely**

Get the April eBook now <- click here







# ALLAGASH

**TRACKSIDE ACTION**



**GET IT NOW >>**

download or DVD

[store.mrhmag.com](http://store.mrhmag.com)

**Model Railroad**  
Hobbyist *Store*

# SELECTED EVENTS



Model Railroad Hobbyist | April 2020

## APRIL 2020

*(Many events charge a fee. Check individual info website for details.)*

*\*Due to concerns about the spread of the coronavirus, many events have been, or will be, canceled. Readers should refer to organizers' websites to determine the status of specific events.*

**\*CANCELLED CANADA, ONTARIO, FENWICK**, April 19 and 26, Open House sponsored by Greater Niagara Model Railroad Engineers, at 1141 Maple Street. Info at [www.gnmre.ca](http://www.gnmre.ca).

**\*POSTPONED NEW ZEALAND, CHRISTCHURCH**, April 10-13, National Model Railroad Convention. Info at [www.model-railcon.co.nz](http://www.model-railcon.co.nz).

**\*CANCELLED CALIFORNIA, CONCORD**, April 30-May 2, Clear to the Coast convention co-hosted by NMRPA Pacific Coast Region and Western Railway Museum, at Crowne Plaza Concord/Walnut Creek, 45 John Glenn Drive. Info at [pcrnmra.org/conv2020](http://pcrnmra.org/conv2020).

**CALIFORNIA, GLENDALE**, April 6, Glendale Model Railroad Society Open House, 619 Hahn Ave. Info at [www.gmrrs.org](http://www.gmrrs.org).

**\*CANCELLED CALIFORNIA, OCEANSIDE**, April 11, Train Show & Swap Meet sponsored by North County Model Railroad Society at Heritage Park. Info at [swapinfo@ncmrs.org](mailto:swapinfo@ncmrs.org).

**\*CANCELLED COLORADO, COLORADO SPRINGS**, April 17-18, TECO-Train Expo Colorado, at Chapel Hills Mall. Info at [www.tecoshow.org/tecoswap.htm](http://www.tecoshow.org/tecoswap.htm).

**\*CANCELLED COLORADO, COLORADO SPRINGS**, April 17, Track to Success Train Show, held in conjunction with the TECO Train Expo. Request info from Al Hovey at [alhovey@comcast.net](mailto:alhovey@comcast.net).

**\*CANCELLED FLORIDA, DELAND**, April 4, Model Train Show at Volusia County Fairgrounds.

**\*CANCELLED INDIANA, FRANKLIN, (Metro Indianapolis)**, April 4, Franklin Spring Train Show, sponsored by NMRA Central Indiana Division at Johnson County Fairgrounds, 250 Fairground Street. Info at [www.cidnmra.org](http://www.cidnmra.org).

**IOWA, DAVENPORT**, April 18, Model Railroad Show at Mississippi Valley Fairgrounds, 2815 W. Locust Street. Request info from Roger Kujawa at [AGWRailway@gmail.com](mailto:AGWRailway@gmail.com).

**\*CANCELLED MICHIGAN, BLISSFIELD**, April 18-19, Model Railroad Open House, at Blissfield Model Railroad Club, 109 E. Adrian St (US223). Info at [bmrr.org](http://bmrr.org).

**\*CANCELLED MONTANA, HELENA**, April 26, 40th Annual Helena Railroad Fair, at Helena Civic Center, 340 Neill Avenue. Info at [www.facebook.com/pages/category/Event/Helena-Railroad-Fair-225320020901434](https://www.facebook.com/pages/category/Event/Helena-Railroad-Fair-225320020901434).

**\*CANCELLED NEW MEXICO, ALBUQUERQUE**, April 2-4, Sn3 Symposium. Info at [sn32020abq.org](http://sn32020abq.org).

**\*CANCELLED OREGON, ELSIE**, April 4, 16th Annual Pacific Model Loggers' Congress, hosted by Lon Wall and Jeff Johnston at Camp 18 Restaurant and Logging Museum, 42362 Highway 26. Info at [www.pacificmodelloggerscongress.com](http://www.pacificmodelloggerscongress.com).

**\*CANCELLED OREGON, EUGENE**, April 21-24, Make Tracks to Eugene 2020 Convention, hosted by NMRA Pacific Northwest Region, at Valley River Inn, 1000 Valley River Drive. Info at [www.MakeTracksToEugene.com](http://www.MakeTracksToEugene.com).

## May by location

**\*CANCELLED CANADA, BRITISH COLUMBIA, BURNABY**, May 22-24, 2020, 5th Annual Railway Modellers Meet of BC, sponsored by Burnaby Railway Modellers at Simon Fraser University's Burnaby campus. Info at [www.railwaymodellersmeetofbc.ca](http://www.railwaymodellersmeetofbc.ca).

**NEW ZEALAND, DUNEDIN, MOSGIEL**, May 9-10, Model Train Show at Taieri Bowling Club, 12 Wickliffe Street. Request info from Trevor Buchanan at [dunedinmodeltrainshow@gmail.com](mailto:dunedinmodeltrainshow@gmail.com).

**CALIFORNIA, SANTA CLARA**, May 21-23, Combined O Scale West and S Scale Meet, at Hyatt Regency Hotel, 5101 Great America Parkway. Info at [oscalewest.com](http://oscalewest.com).

**\*POSTPONED ILLINOIS, EAST PEORIA**, May 14-17, NMRA Midwest Region Convention, at Holiday Inn, 101 Holiday Street. Info at [www.peoriarocket2020.org](http://www.peoriarocket2020.org).

**KANSAS, HERINGTON**, May 2-3, Herington Railroad Days and NMRA Meet, sponsored by NMRA Central Division, at Herington Community Building, 800 South Broadway.

**\*CANCELLED OHIO, HILLIARD**, May 15-17, Central Ohio 12th Annual NTrak Weekend, at Franklin County Fairgrounds, 4100 Columbia Street. Info at [www.centralohiontrak.org](http://www.centralohiontrak.org).

**PENNSYLVANIA, PITTSBURGH**, May 28-31, NMRA Mid Central Region Steel City Express Convention, at Doubletree by Hilton Greentree, 500 Mansfield Avenue. Info at [www.keystonedivision.org](http://www.keystonedivision.org).

**\*CANCELLED SOUTH DAKOTA, SIOUX FALLS**, May 14-17, NMRA Thousand Lakes Region 2020 Convention, at Best Western-Ramkota Hotel Conference Center, 3200 West Maple Street. Info at [dakotasoutheastern.org](http://dakotasoutheastern.org).

**TENNESSEE, NASHVILLE**, May 31-June 6, National Garden Railway Convention, at Gaylord Opryland Resort. Info at [ngrc2020.com](http://ngrc2020.com).

**\*CANCELLED VIRGINIA, FISHERSVILLE**, May 17, 34th Annual Shenandoah Valley Model Train & Railroading Show, sponsored by Augusta County Model Railroad Club at Augusta Expo, 277 Expo Road. Info at [www.acmrrc.org](http://www.acmrrc.org).

## Future 2020, by location

**\*POSTPONED AUSTRALIA, SYDNEY, ROSEHILL NSW**, June 5-9, 34th National Model Rail Convention.

**ARKANSAS, JACKSONVILLE**, August 22-23, 10th Annual Jacksonville Train Show, sponsored by Tuscarora Lumber Company at Jacksonville Community Center, 5 Municipal Drive. Request info from Daryl Conner at 501-982-6835.

**FLORIDA, TALLAHASSEE**, June 27, 26th Annual Model Railroad Show & Sale at Forth Florida Fairgrounds, Info at [www.facebook.com/events/564525630749478](http://www.facebook.com/events/564525630749478).

**KANSAS, HUTCHINSON**, June 6-7, Center of the Nation Model Railroad Expo, at Kansas State Fairgrounds, Pride of Kansas Building, 2000 N Poplar. Info from [kansascentralmodelrailroaders.org](http://kansascentralmodelrailroaders.org).

**MASSACHUSETTS, GARDNER**, October 3, O Scale Model Train Show, sponsored by Southern New England Model Railroad Club, at United Methodist Church, 161 Chestnut Street. Info at [www.snemrr.org](http://www.snemrr.org).

## SELECTED EVENTS | 5

**MICHIGAN, EAST LANSING**, November 22, Train Show & Sale hosted by Lansing Model Railroad Club at Michigan State University Pavilion, 4301 Farm Lane. Info at [lmrc.org](http://lmrc.org).

**MISSOURI, ST. CHARLES (METRO ST. LOUIS)**, September 2-5, 40th National Narrow Gauge Convention, St. Charles Convention Center/Embassy Suites Hotel. Info at [www.40nngc.com](http://www.40nngc.com).

**MISSOURI, ST. LOUIS**, July 17-19, National T-TRAK Layout Exhibit and N Scale Banquet at 2020 National Train Show. Info at [nationalt-traklayout.com](http://nationalt-traklayout.com).

**MISSOURI, ST. LOUIS**, July 12-18, 2020, NMRA National Convention and National Train Show. HQ at Hilton St. Louis at the Ballpark. Info at [gateway2020.org](http://gateway2020.org).

### Beyond 2020, by date

**CALIFORNIA, SANTA CLARA**, 2021, NMRA National Convention and National Train Show.

**ENGLAND, BIRMINGHAM**, 2022, NMRA National Convention and National Train Show. [www.nmra2022uk.org](http://www.nmra2022uk.org). ■



## DOWNLOAD ISSUE

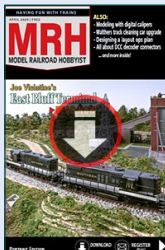

DOWNLOAD PORTRAIT



DOWNLOAD LANDSCAPE

# All new website!

## TRAINMASTERS TV

TRAINMASTERS TV

Filters

### What's new



### Free videos



### TMTV monthly shows

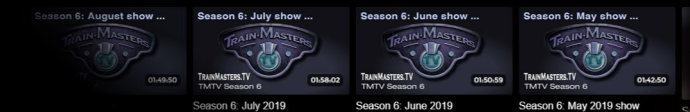

Now  
30%  
off!

### What's new:

- enhanced global-class video player
- 1080p playback on last three seasons
- Netflix-style video category browsing
- Rent/buy individual episodes (1.99 and up)
- Lots more free videos
- Apple, Android, and Roku apps!

Check it out!

[www.trainmasters.tv](http://www.trainmasters.tv)



iPhone, iPad, Apple TV



Roku



# DINE IN STYLE



**REAL CHINA**



**HO SCALE CHINA**

**CLICK HERE**



# CLICKABLE ADVERTISER INDEX

[Accu-Lites](#)

[Archer Fine Transfers](#)

[Athearn](#)

[Atlas Model Railroad Co.](#)

[Bachmann](#)

[Berrett Hill Trains](#)

[Bethel Terminal Models](#)

[Black Cat Publishing](#)

[Blair Line](#)

[Canyon Creek Scenics](#)

[Coffman Graphics](#)

[Crew Call with Mike Rose](#)

[Crow River Products](#)

[Digitrax \(2 page spread\)](#)

[East Coast Circuits](#)

[El Dorado](#)

[ESU LokSound](#)

[Fast Tracks](#)

[Great Decals](#)

[Inter-Action Hobbies](#)

[Iowa Scaled Engineering](#)

[Litchfield Station](#)

[Logic Rail Technologies](#)

[Micro-Trains Line](#)

[Model Railroad Control Systems](#)

[Model Rectifier Corporation](#)

[Mountain Subdivision Hobbies](#)

[Model Train Man](#)

[Monashee Laser Engineering](#)

[Monroe Models](#)

[MRH Store \(1\)](#)

[MRH Store \(2\)](#)

[MRH Store \(3\)](#)

[MRH Store \(4\)](#)

[MRH Store \(5\)](#)

[Mt. Albert Scale Lumber](#)

[NCE \(2 page spread\)](#)

[North American Railcars \(PWRS\)](#)

[Pre-Size Model Specialities](#)

[Precision Design Co.](#)

[Rapido \(1\)](#)

[Rapido \(2\)](#)

[Ring Engineering \(1\)](#)

[Ring Engineering \(2\)](#)

[Roomettes](#)

[ScaleTrains.com](#)

[Southern Digital](#)

[Streamlined Backshop Services](#)

[The TrainMaster, Inc.](#)

[The National Train Show \(St. Louis\)](#)

[TrainMasters TV \(1\)](#)

[TrainMasters TV \(2\)](#)

[Tam Valley Depot](#)

[24 Trains.tv](#)

[Walthers](#)

[Westerfield Models](#)

---

Clickable "other" index

[Other – Contents](#)

[Other – Cover](#)

[Other – MRH Marketplace](#)

[Other – MRH Sponsors](#)

# COMING NEXT MONTH IN MRH ...

John Russell's late '40s Rock Island ... in O scale!



Lightweight ops for any sized layout ...



HAVING FUN WITH TRAINS  
MAY 2020 | FREE

# MRH

MODEL RAILROAD HOBBYIST

John Russell's  
**Steam-era Rock Island**  
▶ **READ NOW**

## Animating a Ferris Wheel ...

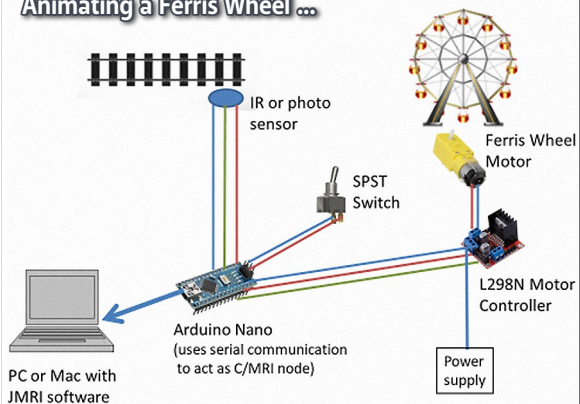

... coming in the  
May MRH

# COMING NEXT MONTH IN *RUNNING EXTRA* ...

... all the MRH articles and ads, *PLUS*:

Tony Sissions models a Virginian battleship gon ...



Mag 2020 - \$2.99

## **MRH** ***RUNNING*** EXTRA

Apprentice with savvy modelers

**Tony Sissions on**  
**Modeling a Virginian battleship gon**  
▶ **READ NOW**



**Also these articles:**

- Lorem ipsum dolor sit amet
- Consectetur adipiscing elit morbi
- Vestibulum tempus vehicula
- Mauris tempor libero ipsum pellentesque
- Nullam porta ut arcu at lobortis

... and much more!



... all this and much more!

**RE SUBSCRIBE: 1YR \$19.99**